

# CENTRIFUGAL COMPRESSOR EVOLUTION

by

**James M. Sorokes**

**Principal Engineer**

**and**

**Mark J. Kuzdzal**

**Manager of Core Technologies**

**Dresser-Rand Company**

**Olean, New York**



*James M. (Jim) Sorokes is a Principal Engineer with 34 years of experience at Dresser-Rand Company, in Olean, New York. He is involved in centrifugal compressor research and development testing. He previously spent 28 years in the Aerodynamics Group, becoming the Supervisor of Aerodynamics in 1984 and promoted to Manager of Aero/Thermo Design Engineering in 2001. During Mr.*

*Sorokes' time in the Aerodynamics Group, his primary responsibilities included the development, design, and analysis of all aerodynamic components of centrifugal compressors. His professional interests include: aerodynamic design, aeromechanical phenomenon (i.e., rotating stall), and other aspects of large centrifugal compressors.*

*Mr. Sorokes graduated from St. Bonaventure University (1976). He is a member of AIAA, ASME, and the ASME Turbomachinery Committee. He has authored or coauthored more than 35 technical papers and has instructed seminars and tutorials at Texas A&M and Dresser-Rand. He currently holds two U.S. Patents and has two other patents pending.*



*Mark J. Kuzdzal is the Manager of Core Technologies at Dresser-Rand Company, Olean Operations, in Olean, New York. He is responsible for overseeing rotordynamics, aerodynamics, materials, welding, solid mechanics, and acoustics disciplines. He has been with the company since 1988. Mr. Kuzdzal's areas of expertise are rotordynamics, bearing performance, field vibration issue resolution, and product/process development.*

*He has coauthored many technical papers and holds two U.S. Patents.*

*Mr. Kuzdzal has a B.S. degree (Mechanical Engineering, 1988) from the State University of New York at Buffalo.*

## ABSTRACT

This paper addresses the advancements that have been made during the past 50 years in the design, analysis, and manufacturing methods for centrifugal compressors. The paper provides a historical perspective on these disciplines, citing how they and other technological innovations have contributed to significant improvements in the aerodynamic and mechanical performance of modern turbomachines.

## INTRODUCTION

The first industrial application of centrifugal or radial compressors was in conjunction with early gas turbine work done around the turn of the 20th century. Some of the earliest work was done by Elling, who developed the first gas turbine to generate positive power in 1903 (Bolland and Veer, 2003). Such compressors have also been used by the process industry since the early 1900s. One of the earliest applications was as blast furnace blowers for steel mills. For example, this original equipment manufacturer's (OEM's) first record of a centrifugal compressor was serial number 7, sold to Scullin Steel Company of St. Louis, Missouri, in 1912. These blowers were quite often very large machines even by today's standards. While they included fundamentally the same components (bearings, seals, impellers, diffusers, etc.), the machine components of that era differed significantly from the complex internals in compressors offered by OEMs today.

This paper traces the evolution of centrifugal compressors and their internals from the relatively primitive machines of the early 20th century to the sophisticated turbomachines of the 21st century. The paper will cite the role of advanced manufacturing methods as well as the importance of advanced analytical methods in the development of today's complicated equipment.

### *Historical Perspective*

Improved manufacturing methods have been a key factor in the development of today's high-performance centrifugal turbomachines. It would make little sense to apply modern sophisticated analytical and design techniques if manufacturing methods were not available

to precisely build the complex shapes required to achieve the high performance. Today's manufacturing methods are critical to the current high efficiency levels. Such has not always been the case.

In the early days of process centrifugal compressor development, design choices were restricted in large part by the manufacturing methods available at that time. OEMs had to create designs that could be fabricated with the limited number of methods available. These included machining (i.e., turning, 3-axis milling), joining (i.e., welding, riveting) and castings.

Machining techniques were limited to turning and 3-axis milling. Such methods are capable of creating fairly simple 2-D shapes. While these are adequate for a wide range of compressor applications, they proved to be inadequate for high flow and/or high Mach number machines (more on this later). To create the more sophisticated shapes for higher flow applications, OEMs were forced to use welded fabrications or castings. In fact, the welded impeller did not become commonplace in process machinery until the late 1950s or early 1960s. Therefore, prior equipment included impellers that were either cast or fabricated via riveting. Some of the earliest riveted impellers date back to the early 1920s.

Likewise, stationary components were fabricated via welded assemblies or casting. Castings were the method of choice for most OEMs because of:

- The cost advantages attained when multiple copies of the same component were required; and
- Optimized performance was not a critical consideration at this time.

The use of castings for compressor casings was prevalent through the mid 1950s. However, castings were characterized by rough surfaces, which compromised the achievable aerodynamic performance. Still, it was not unusual for the flow path of a process centrifugal to be composed entirely of cast components. In most machines from that era, those parts that were not cast were either welded, bolted, or riveted fabrications.

In these early machines, the primary driver (as defined by the end users) was that the unit compresses gas. Energy consumed was not a major consideration. However, as the cost of energy increased and as competition escalated between OEMs, it became necessary to develop higher levels of compressor performance.

The general trend of peak compressor efficiency over the past 60 years is shown in Figure 1. Note that this curve represents centrifugal compressor stages with a flow coefficient,  $\phi$ , greater than 0.080. Stages with lower flow coefficients will have lower attainable peak efficiencies due to higher frictional losses, etc. As can be seen, in the 1950s, efficiencies were typically in the range of 70 percent to 75 percent. Energy was abundant, so the relatively low centrifugal compressor performance was not a concern. However, the energy crisis of the mid-to-late 1970s caused compressor users and OEMs to give greater attention to reduced power consumption. Significant strides were made in driver and compressor performance during those years as efficiency levels reached 80 percent to 85 percent. Further improvements continued through the 1990s and into the new century and optimal efficiency levels have now reached the upper 80s and are pushing toward 90 percent. However, it is commonly held that the multistage centrifugal compressor industry is approaching an asymptotic efficiency limit. The ultimate limit is the subject of much conjecture but most place the limit between 90 percent and 92 percent polytropic efficiency. That is, it might not be practical or even possible to design a multistage process centrifugal compressor that will achieve greater than 92 percent efficiency. Obviously, Newton's Laws and the Laws of Thermodynamics are sacrosanct and dictate the impossibility of reaching 100 percent efficiency. In addition, there are some fundamental losses (i.e., secondary flows, boundary layer effects,

leakage effects, windage, bearing friction, shear forces, etc.) that cannot be avoided in centrifugal stages. Current thinking is that these losses will limit the industry to approximately 90 to 92 percent for multistage machines (Shepherd, 1956; Japikse and Baines, 1994; Sorokes, 1995; Aungier, 2000).

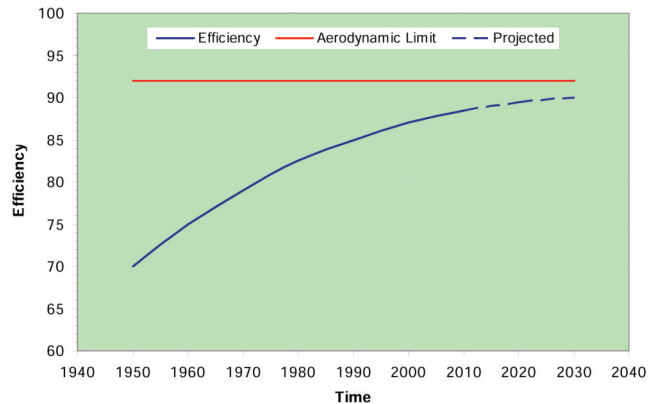

Figure 1. Efficiency Trends.

Note the reduced slope of the efficiency increase over the past decade as compared to prior decades. Clearly, there is diminishing return for the investments being made to achieve higher efficiency simply because there is less efficiency improvement to be gained. Further improvements are possible by:

- Addressing what had previously been considered secondary or tertiary performance factors such as leakage paths;
- Developing ever more sophisticated aerodynamic components; or
- Merging of axial and radial centrifugal technologies.

These efforts might result in higher stage or compressor efficiency but they might do so at the expense of overall flow range (Sorokes, 2003). While it is possible that the theoretical ceiling will be broken, incremental changes in efficiency over the next decade will certainly be measured in quarter, half and single points rather than the five to 10 point improvements achieved in earlier decades.

The subject of increased performance will be addressed further in the "LOOKING FORWARD" section later in the paper. However, before considering the future, the discussion will turn to the factors that contributed to the performance improvement from the 1950s through 2010. These will be broken down in two major categories: aerodynamics and mechanical. In each category, the key components will be presented along with the improvements possible because of the advances in manufacturing and analytical techniques.

## AERODYNAMICS

The key aerodynamic components in the centrifugal compressor are the inlet, inlet guidevane (IGV), impeller, diffuser, return channel, volute, and sidestream (or side entry/exit). All have benefitted greatly from improved manufacturing and analysis methods. Several of these components will now be discussed in decreasing order of importance.

### Impellers

Clearly, attaining high performance from a centrifugal compressor demands superior aerodynamic designs and there is no more critical component to achieving such than the centrifugal impeller. The impellers are responsible for all of the work added to the gas stream, so it is not possible to achieve high efficiency in an overall compressor or in a compressor stage without a very well-designed impeller. No amount of tuning in the stationary components can make up for a poorly-designed impeller. A very large portion of the efficiency gain over the past few decades has been due to the more

sophisticated impeller geometries made possible by the progress made in manufacturing and analytical practices.

As mentioned in the introduction, early impellers were typically fabricated via welding, brazing, riveting or castings. Each method imposed limits on the attainable impeller geometry and, consequently, on the achievable performance.

In the 1950s or 1960s, OEMs began offering welded impellers. These fell into two categories: two-piece or three-piece welded. In the two-piece configuration, the impeller blades were 3-axis milled onto the cover (shroud) or disk (hub) and were then fillet welded to the disk (hub) or cover (shroud). Because of the 3-axis milling, the blade shapes were typically 2-D in nature, i.e., sections of circles, ellipses or some other 2-D geometry shape. Such shapes severely limit the aerodynamics of the design but this was all that 3-axis milling would allow. Further, to fillet weld the impeller, the passage opening had to be large enough to accommodate the weld fixtures (typically 0.6 inch [15.25 mm] or larger). Therefore, welded impellers for very low-flow coefficient impellers, with their inherently narrow flow passage, were not possible. Such narrow impellers were built via “through the blade” riveting (Figure 2) and/or casting.



Figure 2. Riveted Impellers.

To achieve reasonable performance in higher flow coefficient stages, i.e.,  $\phi > 0.040$ , it is imperative that the impeller inlet blade angles match the non-uniform inlet flow angles. An explanation is in order.

In high-flow coefficient stages, there is a large variation in approach angle at the impeller inlet from the shroud to the hub. This is due to the variation in the peripheral and meridional velocity at the impeller inlet (Figure 3). The peripheral velocity,  $U_{1x}$ , is a function of the diameter at the various locations so  $U_{1s}$  is much higher than  $U_{1h}$  in high flow coefficient stages where there is inherently a large change diameter from shroud to hub.

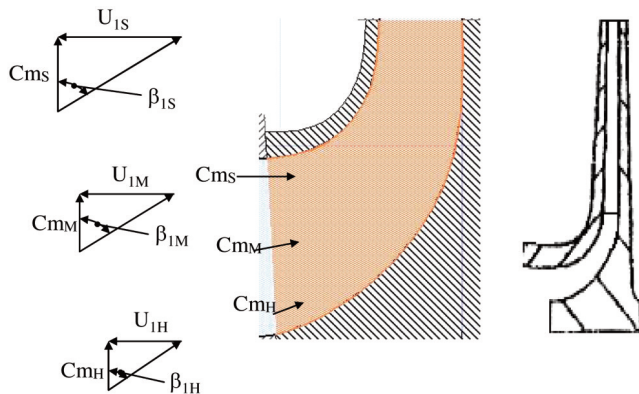

Figure 3. Impeller Inlet Velocity Distribution.

In addition, there is also a change in local curvature in the leading edge between the shroud and hub. The meridional velocity,  $C_{xm}$ , is impacted by this local curvature such that  $C_{1s}$  is higher

than either  $C_{1m}$  or  $C_{1h}$ . For further discussion on this subject, refer to Sorokes and Kopko (2007). The result of the variation in  $U_{1x}$  and  $C_{1x}$  is that there is a significant difference in the gas approach angle between the shroud and hub. The only way to match these angles is to use a 3-D blade shape that has a varying inlet angle across the leading edge.

As end users required higher and higher flow rates, many OEMs did apply 2-D blading in high-flow coefficient stages but the performance of these machines was compromised because of the less-than-optimal flow incidence caused by the 2-D shapes.

As the demand for higher performance increased, OEMs were forced to develop methods to manufacture 3-D blading. Early approaches included castings or 3-piece fabrication. In the former, the 3-D blade shapes could be created via casting of complex patterns, providing the leading edge angles necessary to achieve reasonable incidence angles. In the 3-piece fabrication, the “three pieces” were the shroud, the hub, and X number of blades. In the most primitive 3-D designs, the blade shapes were sections of cones, cylinders or toruses. These could be readily formed via rolling or stamping. However, these shapes, while providing improved incidence, did not provide adequate control over the area distribution through the impeller passage. More complex shapes were required... the so-called arbitrary blade shapes. The name arbitrary is derived from the fact that there is no geometric shape that can replicate the blade shape. The shape is defined by line elements in space or a mesh of points. The need to define such shapes gave rise to a number of “geometry generator” software packages, the descendants of which are still in use today (more on this later).

The blades (geometric or arbitrary) were formed via die-pressing or other methods of forming with the blades compared against a check block to ensure the proper shape. However, the blades often deviated from the desired shape because of “spring-back” (caused by the elasticity of the material itself or due to shape change as the blade cooled). The blades were then welded or riveted to both the cover and disk to create the impeller (Figure 4). Blade locating fixtures, ranging from simple to elaborate, were developed to minimize the placement variation blade-to-blade. These variations were typically small in the riveted impellers but could be significant in welded designs due to distortions caused by the welding and heat treatment. Further, the welded impellers were grit-blasted to remove any weld residue or the oxide scale formed during the heat treat process to permit surfaces to be inspected with die-penetrant or magnetic particle nondestructive test methods. This grit-blasting caused a rough surface finish so impellers often had to be ground, polished, or honed to achieve the desired finish.

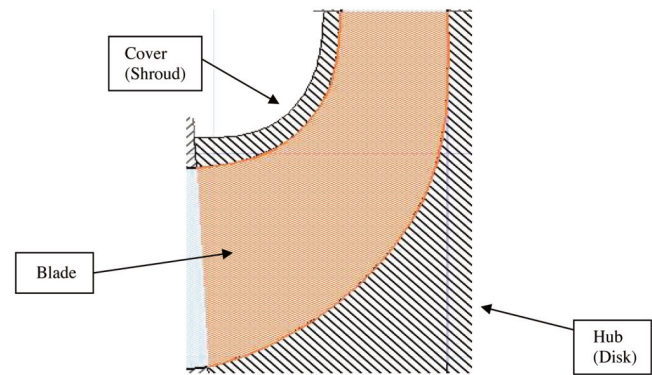

Figure 4. Definition of Impeller Components.

All of the concerns regarding blade accuracy and most of the surface finish issues were resolved with the introduction of 5-axis milling. Flank or point milling eliminated the need for die-pressing or forming as the blades could be milled from a disk forging. This

reduced the amount of welding because one end of the blade was integral with the disk (or cover). Of course, the positioning of the milled blades was also far more precise than was achievable with the 3-piece fabrications. The more uniform blade-to-blade spacing also contributed to higher aerodynamic performance.

More recently, OEMs have begun to single-piece machine covered impeller from a single forging, thus eliminating the need to weld or join the cover (or disk) to the blading. The individual impeller passages are machined by plunge milling from the inside and outside diameter of the impeller. The inner and outer cuts are then tied together near the center of the individual flow passage. The “integral joint” in such a design is stronger than any welded or brazed joint, providing a more robust impeller in applications requiring additional joint strength. However, there are limits to the single-piece milling approach due in large part to limits in cutter technology. In the plunge milling process, it is impossible to reach some of the passage surfaces with conventional cutters. Therefore, special “lollipop” cutters were developed to reach these locations (Figure 5). However, there is a limit in the overall length to diameter ratio of these cutters, thereby limiting the depth that can be cut in narrower flow passages. As such, single-piece milling is typically limited to larger diameter, higher flow coefficient impeller designs (i.e.,  $\phi > 0.040$ ,  $D_2 > 15$  inch [381mm]).

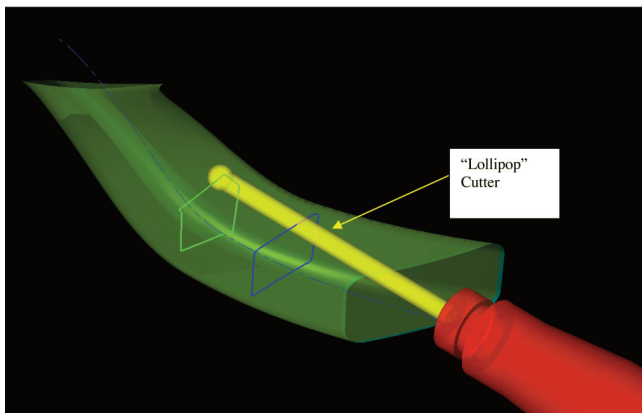

Figure 5. Special “Lollipop” Cutters for Single-Piece Milling.

The fabrication of low-flow coefficient stages provided another challenge to OEMs. Such stages are very important for high pressure applications such as reinjection, syn-gas applications, and the like. Given the very low flows required, it became necessary to develop methods to accurately fabricate impellers with very narrow flow passages. As noted previously, fillet welding required a minimum opening of 0.6 inch (15mm). Therefore, fillet welding was not an option for the small passages required.

Riveting was used for early applications but was unacceptable as the required operating speeds and associated stresses increased. The next alternatives developed were brazing and slot-welding. These are still in use today but both have a few disadvantages. The brazed joint lacks the strength of most welded joints if the braze material is too thick. This can result if the gap between blades and adjacent wall is too large. A quality braze requires a very small gap between the blades and adjacent wall, i.e., on the order of 0.001 inch to 0.003 inch (0.025 to 0.075 mm). Slot-welding provides a stronger joint than brazing. However, in slot-welding, the base metal of the disk (or cover) and the base metal of the blading are melted, leading to some inaccuracy in the impeller passage height. As a result, the distortion in the flow passages caused by the welding that can impact the capacity of the impeller, causing it to be smaller than expected. The blade material is not melted during the brazing process, leaving an inherent “mechanical lock” that keeps this “shrinkage” from happening but, again, the braze joint is weaker.

To address the shortcomings, OEMs turned to an electron beam welding process, a method originally developed by the aircraft industry. In electron beam welding, all of the base metal of the blading is not melted, providing a “mechanical lock” similar to brazing, ensuring passage height accuracy. In the early 1990s, a variation to the electron beam process was developed called EBraze® welding (Miller, 1996). Under this new method, the cover (or disk) is joined to the blading with a combination of electron beam welding and brazing. This greatly improves the fatigue strength in the joint by eliminating the stress riser associated with the unfused portion of the traditional electron beam weld. Therefore, accurate, robust low flow coefficient impellers can be fabricated via the various types of electron beam welding.

Other alternatives for low flow coefficient designs include electro-discharge machining (EDM) or electrochemical machining (ECM) as well as fabricating impellers from powdered metal. Each of these methods has limitations that must be carefully considered when developing new low flow coefficient designs.

One final point about low-flow coefficient impellers: 2-D blade shapes are very appropriate given the narrow flow passages common in such designs because there is little or no variation in the flow angles from hub-to-shroud. Therefore, it is commonplace to find 2-D blades in low-flow coefficient impellers.

### Diffusers

Diffusers are the second most important aerodynamic component in a centrifugal stage so it comes as no surprise that they have evolved substantially from the early days of centrifugal compressors. The diffuser converts a portion of the remaining kinetic energy in the gas stream (velocity pressure) into static pressure (potential energy), further reducing the volumetric flow.

Centrifugal compressor diffusers fall in two broad categories: vaneless and vaned. As indicated by their name, vaneless diffusers contain no vanes. Conversely, vaned diffusers contain one or more rows of vanes. In general, vaneless diffusers offer the widest flow range because there are no vanes to interfere with the gas as it passes through the diffuser. However, the static pressure recovery in vaneless diffusers is not as high as in their vaned counterparts. Therefore, the peak attainable efficiency for stages with vaneless diffusers is not as high (Figure 6).

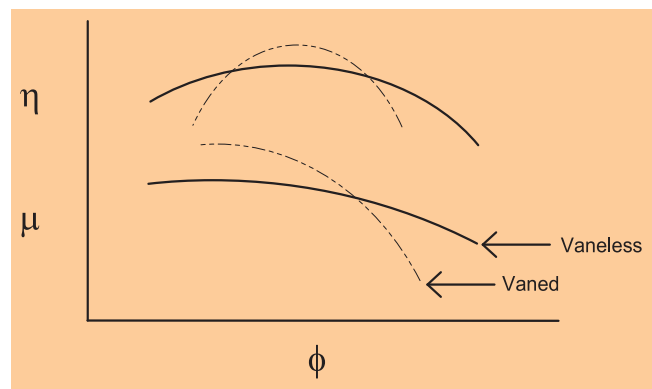

Figure 6. Performance Characteristic—Channel Versus Vaneless Diffuser.

Vaneless diffusers were the dominant style in early centrifugal compressors because of their simplistic design. The parallel or tapered walls were easy to machine via turning. Therefore, it was possible to achieve some very good surface finishes, a necessity for high performance in vaneless diffuser. However, the limited peak static pressure recovery (typically less than 50 percent) restricted the peak efficiency achievable with vaneless diffusers.

Some process compressor OEMs attempted to apply channel diffusers. The name comes from the fact that two adjacent diffuser vanes form a passage or channel (Figure 7). These diffusers do provide superior static pressure recovery,  $C_p$ , with peak  $C_p$  levels reaching 75 percent to 80 percent. However, channel diffusers also cause a substantial reduction in flow range, making them undesirable for compressors that must operate over a range of flow conditions. As a result, channel diffusers are rare in process compressors but somewhat popular in air machines, gas turbine gas generator compressors, or turbochargers, which do not require wide flow range.

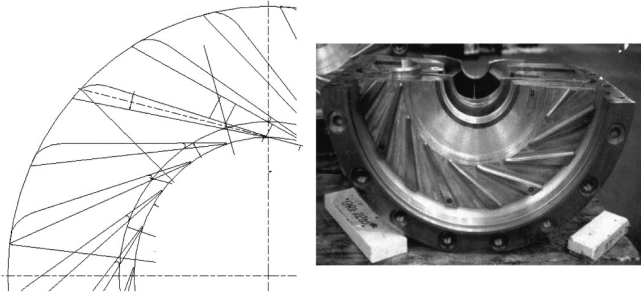

Figure 7. Channel Diffuser.

Vaneless diffusers were the most widely-used style in industrial centrifugals until the late 1980s when some OEMs began applying a style known as the low solidity vaned diffuser. Unlike the channel diffuser, the vanes in a low solidity vaned diffuser (LSD) do not form a channel and also have no true geometric throat (Figure 8). Numerous publications in the late 1980s and early 1990s touted the advantages of the LSD style including Senoo, et al. (1983), Osborne and Sorokes (1988), Sorokes and Welch (1992), and Amineni, et al. (1995, 1996). The most important benefit is that LSDs provide nearly the same operating range as a vaneless diffuser yet provide greater pressure recovery and, therefore, higher stage efficiency. The introduction of the LSD provided a step change in stage efficiency without significantly reducing the flow range. However, the efficiency enhancement seemed to be limited to medium- to low-flow coefficient stages, i.e.,  $\phi < 0.080$  and smaller, with the greatest benefit being in flow coefficients,  $\phi$ , less or equal 0.030.



Figure 8. Low Solidity Vaned Diffuser (LSD).

More recently, select OEMs have reintroduced the rib diffuser, a special class of LSD with vanes that do not cross the entire flow passage (Figure 9). These diffusers were first suggested in the mid-to-late 1970s but did not gain broad acceptance until much later. Again, this style of diffuser provides an efficiency boost in some flow coefficient ranges but is ineffective in others. Those seeking more details on this style are directed to the work of Sorokes and Kopko (2001).

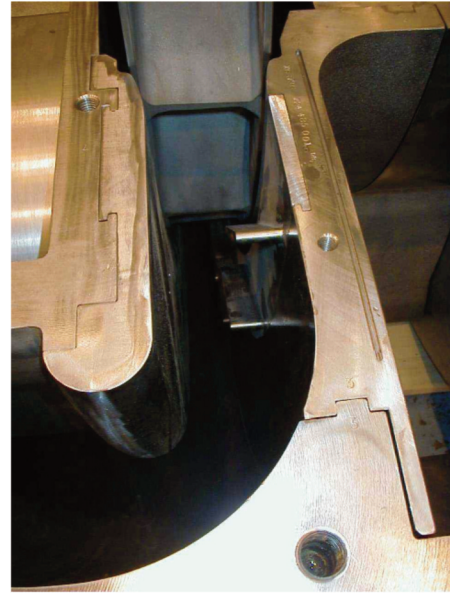

Figure 9. Rib Diffuser.

*Other Components: Inlet Guides, Return Channels, Volutes, Inlets Sidestreams and Casings*

The stationary components in most early centrifugals were constructed via casting. Typical issues associated included core shifts, varying vane thicknesses, and rough surface finishes. All contributed to increased losses and greater uncertainty in performance predictions.

The desire to minimize the number of casing patterns also led to some interesting issues when the return bends or cross-overs were cast into the case. This meant that the diffusers and return channel passages had to align with the fixed return bend location and size. As the return channels were also cast with integral bulbs, the bulb size (or inner portion of the return bend) could not be custom-sized for each application, leading to arrangements such as that shown in Figure 10. These step changes in the flow path were not conducive to high efficiency and also were a prime location for rotating stall cells to form (Marshall and Sorokes, 2000).



Figure 10. Diffuser Discharging into Cast Return Bend.

To address this and other similar issues, OEMs began machining the stationary flow path components. Again, early machine tool technology limited this to the return channels because the vanes could easily be machined on a 3-axis mill. However, as larger 5-axis mills became available, it was possible to machine complex components such as volutes and inlets. It was also possible to mill prewhirl inlet guide vanes via 5-axis machining. In short, by the year 2000, OEMs were building compressors with nearly 100 percent fabricated/machined internal components as compared to the 1950s when nearly 100 percent of the components were cast.

When fabricating the components, attention must be given to the methods to be used to assemble the various parts. Advances in joining technologies contributed to improved quality, reliability and safety. In addition to better welding techniques, innovations in bolting technology also play an important role modern machines. The advent of hydraulic tensioning, super-nuts, and the like facilitated assembly and disassembly of parts and increased product flexibility.

Of course, castings remain a very viable option for component fabrication provided steps are taken to ensure the accuracy of the flow path geometry and a high quality surface finish. It is also advantageous to use steel castings rather than cast iron so that defects are easily repairable via welding or other processes.

#### Analytical Techniques

The evolution in analytical methods has also been a major contributor in the advancement of centrifugal compressor aerodynamic technology. Much of this has been the direct result of the advances in computer technology. As computer technology improved, it was possible to perform more complex mathematic computations in less time. The result was more sophisticated modeling of individual components or entire compressors.

##### 1-D Methods

The most common approach used in 1-D models is the so-called “velocity triangle” methodology. Formulations based on the Euler turbomachinery equation, the Bernoulli equation, conservation of mass, conservation of angular momentum, and other empirical performance models are used to solve for the meridional, tangential, and relative velocities and flow angles at various key locations within a centrifugal stage. Such codes focus primarily on the inlet and exit region of each component and “know” little about the geometry between those locations. As such, they have limited value today other than doing some basic sizing calculations. However, this was the only approach available to turbomachinery designers in the early days.

Prior to the late 1950s, all designs were completed using this approach... and development testing. The design system typically comprised a slide rule, a pencil, a ruler, a compass, a protractor, a drafting board, lots of paper, and human creativity/intellect. Despite the lack of today’s computers and analysis procedures, some very sophisticated designs were created, many as the result of military aircraft engine developments that later found their way into industry. Others were the result of the time-consuming “cut and try” testing where researchers tried a variety of design geometries until a configuration was discovered that met the performance objectives. Clearly, this was not a cost-effective way of developing compressor products but it was the only technique available at the time.

##### 2-D Methods

Introduced commercially in the late 1950s, two-dimensional or 2-D methods provided another level of insight for designers in the development and analysis of aerodynamic components. Unlike 1-D codes, 2-D codes require definition of the entire flow path including hub and shroud profiles as well as blade or vane angle definition and thickness.

The most common 2-D method is the streamline curvature approach. For those unfamiliar with such, streamline curvature codes divide the flow passage into “streamtubes” of constant mass flow, such as is shown in Figure 11. Velocities are calculated based on the local curvatures in the meridional (or hub-shroud) profiles and the mass flow through the streamtube area. Some of these codes are also sensitive to curvature in the blade-to-blade direction.

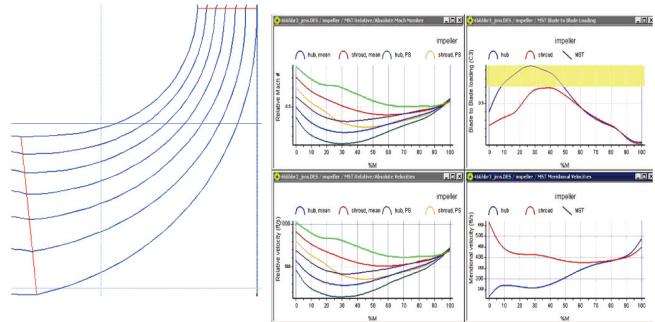

Figure 11. 2-D Streamtube Analysis.

There are also modeling parameters that can be adjusted when running the various 2-D streamline curvature codes. Some of these include: the number of calculation stations (quasi-orthogonals) from inlet to exit; the number of streamtubes dividing the flow passage; loss distributions; curve fits on the geometry; and convergence tolerances.

##### 3-D Methods

Three-dimensional computational fluid dynamics (CFD) codes are the most rigorous analytical techniques that can be used to calculate the flow through aerodynamic components. First widely available to the industrial compressor industry in the late 1980s, such codes provided a major step forward in the ability to understand the flow physics inside the rotating impeller and stationary components as well as the interactions between such.

CFD analyses are performed using computational grids that break the flow passage up into small polyhedrons (e.g., hexahedrons or tetrahedrons), essentially the aerodynamic equivalent of finite element analysis. Consequently, such codes can account for all facets of the aerodynamic component geometry and provide a far more comprehensive approximation of the flow physics than any of the less sophisticated flow codes. As a result, using such codes can lead to superior aerodynamic designs and, therefore, superior performance because untoward flowfield characteristic can be identified and eliminated or minimized.

Highly computational intensive, use of CFD analyses has become more commonplace as high-end computer workstations and workstation clusters have become more readily available. Putting this into perspective, the analysis of a single impeller passage required 18 hours on the most advanced workstation in 1990. The same analysis can be run in approximately 10 minutes today on the average laptop computer.

Because of the computation times involved, initial CFD applications tended to focus on isolated components, in particular, the impeller. However, by the mid to late 1990s, further advances in analytical codes and computers made it possible to include multiple components in the computational domain. Even further advances have allowed analysts to conduct unsteady analyses, allowing an assessment of how transient or time-dependent flow, pressure, or temperature fluctuations impact component or stage performance. Such analyses represent the closest method yet to approximating the real world flow physics inside a compressor. In short, the advances in computer technology have also contributed to the ability to design more efficient centrifugal compressor components.

## ROTOR DYNAMICS

### Undamped Critical Speed Analysis

In the mid-1940s Myklestad developed a new method of calculating modes of uncoupled bending vibration of an airplane wing and other types of beams (Myklestad, 1944). One year later Prohl developed a general method for calculating critical speeds of flexible rotors (Prohl, 1945). These two references form the basis of the Myklestad-Prohl method, which is a transfer matrix solution technique at the heart of the undamped critical speed map commonly used today. Just as an aerodynamicist would use a 1-D analysis as a starting point for a new impeller design, a rotordynamic analyst would use, and still does today, an undamped critical speed map to analytically determine the location of the rotor's natural frequencies as a function of the bearing support system. The undamped critical speed program generates undamped circular synchronous critical speeds from rotor geometry input as a function of symmetrical bearing stiffness coefficients (Figure 12). In the late 1940s through the 1960s the calculation of the first critical speed ( $NC_1$ ) was conducted by hand with the objective of ensuring the intended running speed range of the compressor did not coincide with  $NC_1$ . As computer technology advanced and journal bearing coefficients became common place, the bearing coefficients would be plotted on the undamped critical speed map to "zero-in" on the location of the critical speeds.

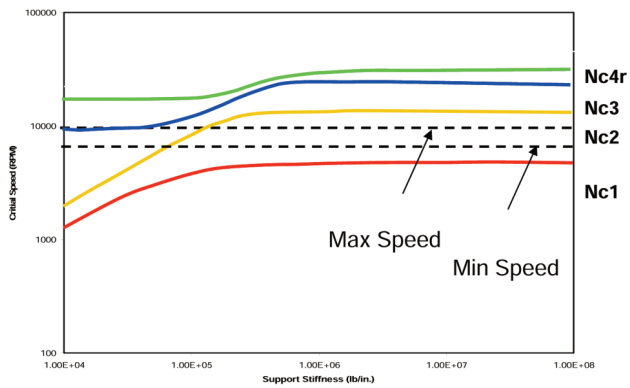

Figure 12. Critical Speed Map.

Often, on the OEM's test stand or in the field, a coin (often a U.S. nickel) would be placed on its edge on a flat spot on the bearing cap (housing). If the nickel did not vibrate and fall, the machine would be classified as "running smooth." This vibration monitoring technique has since been replaced with eddy current proximity probes and advanced data acquisition systems. Nevertheless a nickel is still used, in jest, as a sign of a smooth running machine by designers.

### Synchronous Unbalance Response

In May of 1965, J. W. Lund released Part V of a report prepared for the U.S. Air Force Aero Propulsions Laboratory (Lund, 1965). This landmark publication contained a computer program to determine the unbalance response analysis of a rotor on fluid film bearings. In addition, the report contained the analytical foundation on which the programs are based. Lund describes the basic theory of the rotor response program in his 1967 paper (Lund and Orcutt, 1967). These tools, along with bearing and seal programs that are used to determine oil film stiffness and damping (more on this later), enabled more advanced analysis on rotors. The basic kernel of these codes is still used today but is now being superseded by finite element analysis approaches.

The forced response tool allowed the designer to apply unbalance to the rotor to calculate the rotor's response to unbalance, the location of  $NC_1$  and the amplification factor (API 617, 2002; Childs, 1993). In addition the sensitivity to

unbalance could now be calculated and compared to the OEM's test and field experiences.

### Rotor Stability Analysis

In the early 1970s a series of stability problems was seen in high-pressure gas injection and synthesis gas compressors. Refer to Fowlie and Miles (1975) and Smith (1975) for discussions of the Kaybob compressor, refer to Wachel (1975) for a discussion of the Kaybob and Ekofisk compressors, and Booth (1975) for the Ekofisk compressor. In 1974 Lund published a breakthrough paper on the analysis of rotor stability (Lund, 1974). A program was written based on the theory in this paper (Smalley, et al., 1974). The lateral stability program of Lund was used in the analysis of instability problems at the first natural frequency and in the design of centrifugal compressors to resist subsynchronous vibration. It was common to refer to this as doing a Lund analysis.

The rotordynamics stability code provided the added insight of logarithmic decrement or log dec. The log dec of a system can be characterized in the time domain as the amplitude of successive aptitude peaks. If the amplitudes are decaying over time the log dec is positive, if growing the log dec is negative (Wachel, 1975; Kuzdzal, et al., 1994; Ramesh, 2004) (Figure 13). Certainly, a negative log dec is undesirable. The rotor stability program can also be used to analyze oil-whirl problems in hydrodynamic oil film bearings (De Santiago and Memmott, 2007).

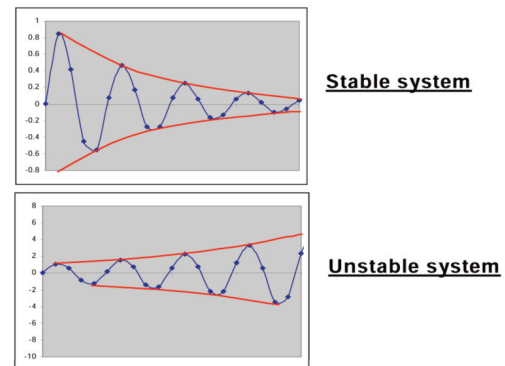
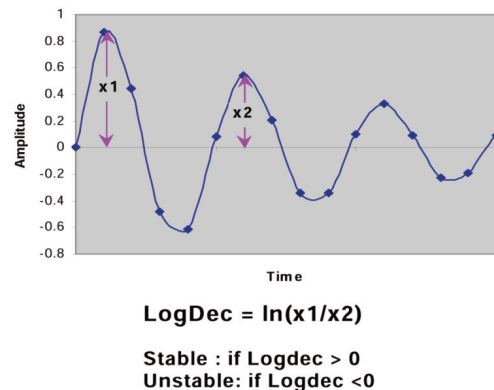

Figure 13. Definition of Log Decrement.

### Hydrodynamic Oil Film Bearing

In the 1970s and 1980s the sources of instability were sometimes difficult to quantify. Certainly, it was understood that if the rotor showed an instability at its first forward whirling mode while operating at full speed it was likely a pure rotor instability. While if the subsynchronous vibration tracked speed or was not at the first critical it may be more related to a forced excitation, an aerodynamics stall or bearing whirl/whip (Marshall, et al., 2000). Hydrodynamic oil film bearings have been used in centrifugal compressors for many decades, but before the introduction of proximity probes, data acquisition systems and rotor stability methods a designer could only characterize

a machine as running “smooth” or “rough.” If a machine was running “rough” one really has no practical means to know why. Could it be the first critical speed, bad bearings, or an excessive unbalance?

As hydrodynamic bearing technology advanced, the designer recognized the need to optimize the plain sleeve bearing. In general, a plain sleeve bearing has a comparatively large load carrying capacity, but performed poorly in rotordynamics stability, often being the source of the issue. Oil whirl (Pinkus, 1956; Newkirk, 1956) was a common term used in the 1960s and 1970s to characterize the maximum speed the bearing could operate at before it generated undesirable instability forces. Resonant whip was used to describe when the unstable frequency locked on to the first natural frequency. Designers in that era worked to modify the inner geometry (profile) of the journal bearing to control the oil whirl and whip characteristics with the intent of increasing the bearing instability threshold speed (Figure 14). Various geometric details such as three and four axial groove bearings, elliptical or lemon bore bearings, offset half bearings and pressure dam bearings were all designed and employed to improve the rotor stability threshold speed. To improve this parameter, generally load carrying capacity or synchronous unbalance response ability was compromised (Figure 15). The advent of four lobe bearings further improved the situation. In this design the curvature of the fixed profile (nonmovable pads) was cut at a larger diameter to form what is today known as bearing preload (Nicholas and Allaire, 1980; Nicholas and Kirk, 1981; Nicholas, 1985).

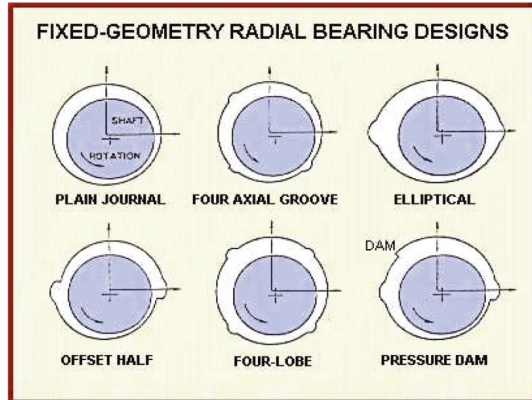

Figure 14. Fixed Geometry Radial Bearing Design.

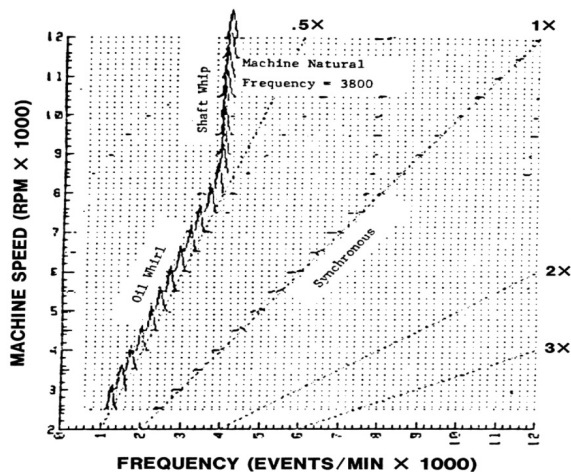

Figure 15. Effect of Oil Whip.

Although tilt pad thrust bearings were invented by Mitchell in 1905 (Australian-English patent) and Albert Kingsbury (U.S.) in 1907, tilt pad journal bearings did not start to become popular until the late 1960s. This OEM’s first known use of a tilt pad journal bearing was a 2.5 inch (63.5 mm) diameter Waukesha bearing used in 1964. Tilt pad bearings offered a distinct advantage over a fixed profile bearing, in

that the bearing had movable pads that significantly reduced the oil film cross-coupling stiffness, thereby increasing the rotor stability.

The first usable program to analyze tilt pad bearings was based on the groundbreaking paper by Lund (1964). The program used the pad assembly method to assemble the synchronous stiffness and damping coefficients from those of the individual pads. Now it is more common to use the program developed by Nicholas (Nicholas, et al., 1979) to analyze tilt pad bearings. To this day, tilt pad bearings are the workhorse hydrodynamic bearing for centrifugal compressors used in the oil and gas industry. Today’s experience has shown successful operating of tilt pad journal bearings with light load at speeds as high as 570 ft/sec (174 m/sec) and with unit loads as high as 775 psi (5434 kPa) at moderate surface speeds. Nevertheless, the world continually strives for new solutions and the bearing arena is no exception.

Magnetic bearings were introduced into the oil and gas market segment in the late 1970s and early 1980s (Hustak, 1986, 1987) when the gas pipeline industry was moving to an oil-free turbomachinery solution. In the late 1990s there was a resurgence as magnetic bearings were seen as an enabler for hermetically sealed oil-free compressors. Finally, researchers developed a method to utilize magnetic bearings to purposely add known quantities of destabilizing forces to a rotor to measure log dec (more on this later).

#### Main Compressor Seals

Main compressor seals have also made significant advances over the years. In the 1910s centrifugal compressors were generally compressing air, which was used to fire blast furnaces in the steel industry. The main seals of these air compressors were aluminum labyrinth (laby) type seals that generally leaked to the atmosphere. But fuel was cheap and the leakage of compressed air was of little concern. In the later decades as centrifugal compressors were being used to compress methane ( $\text{CH}_4$ ) and other combustible gases, leakage to the atmosphere could not be tolerated (Kirk 1986).

Oil seal bushings were utilized for main compressor seals for higher-pressure natural gas applications. Records show oil film seals being used in the 1950s (Figure 16). These seals used oil supplied at a pressure higher than the compressor suction pressure to ensure the volatile gas did not leak to the atmosphere. The introduction of oil film seals brought at least two issues along with it. First, seal oil that came in contact with the process gas could become contaminated (soured) if the gas being compressed was sour; sour gas being any gas mixture containing acidic elements such as hydrogen sulfide ( $\text{H}_2\text{S}$ ) or the like. This generated the need to properly dispose of the contaminated oil. Second, as the pressure increased, the need to understand the stiffness and damping coefficients of the oil film seals also increased. Not until the late 1970s and early 1980s is there evidence in the open literature of OEMs’ working to understand these forces and how they impact machinery vibration characteristics (stability) of the rotor during high-pressure operation (Kirk and Miller, 1977). The authors’ company developed and started supplying a tilting pad oil-film seal in the early 1970s. The tilting pad seal had a significant positive effect on the stability of the compressor (Memmott, 1990, 1992). For a recent paper where a tilting pad seal was used to eliminate an instability seen with an oil-film ring seal refer to Memmott (2004).

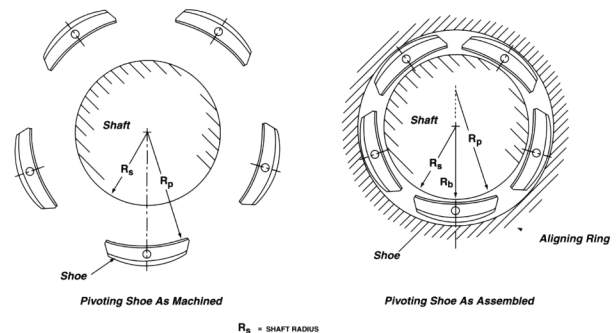

Figure 16. Tilt Pad Bearing.



Today the use of oil film seals is generally reserved for revamp and repair activities (Figure 17). Nearly 100 percent of all new compressors sold in the oil and gas industry feature dry gas seals (DGS). The first known application of a DGS in the authors' company was in a 30 psig (210 kPa) single-stage overhung compressor in 1962. Since that time, the DGS industry has worked hard to gain market acceptance. Still today, the industry standard is a tandem DGS where the full seal delta pressure is let down across one seal face while the secondary seal face does little or no appreciable work (Stahley, 2005). Today as the technology and materials research advances DGS sealing pressure capability continues to rise to meet today's demanding high-pressure applications. Current practical seal running experience is near 3625 psi (250 bar) delta pressure with positive laboratory experience to 5800 psi (400 bar). From a rotor dynamics standpoint one negative attribute that a DGS introduces is an added rotating mass on the rotor. Interestingly enough, the sealing face is orthogonal to the shaft. As a result, the seal stiffness and damping parameters in the radial direction are ignored in a rotordynamics analysis.

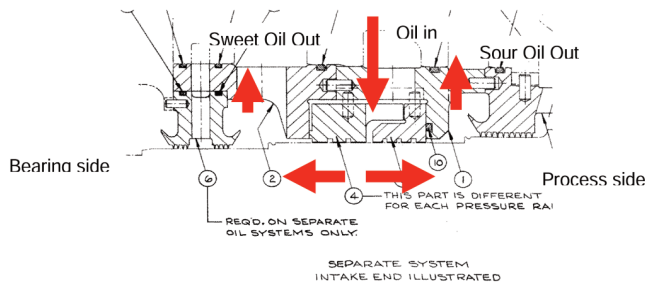

Figure 17. Oil Film Seal.

#### Internal Seals

As speed, power and gas density increase-managing forces inside a centrifugal compressor can mean the difference between a rotor that becomes unstable with increased gas density and a rotor that becomes more stable.

Although tooth labyrinth seals have generally been used to seal impeller stage rise from "bleeding" back to low pressure areas in the machine for decades, a recent advancement to the eye seal and balance piston/division wall seal has been the swirl brake (Figure 18). When properly designed, these stationary vane-like devices can substantially reduce cross-coupling stiffness generated inside a tooth laby by controlling the gas tangential velocity (Moore and Hill, 2000). These swirl breaks can be used on tooth labyrinths as well as damper seals.

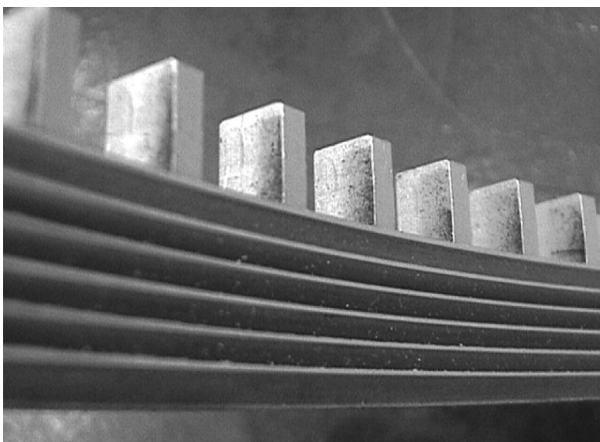

Figure 18. Swirl Brakes.

Damper seals generally take two possible forms: a honeycomb or hole pattern seal (Figure 19). In either form the intention of the seal is to introduce more desirable direct damping than undesirable cross-coupling stiffness, thereby improving the stability of the rotordynamic system. Researchers have completed much laboratory

work (Kleyhans and Childs, 1996; Childs and Wade, 2003) to ascertain accurate leakage and stiffness and damping parameters. Further to that, OEMs have utilized full-load full-pressure testing along with magnetic bearings to inject known amounts of nonsynchronous forces to demonstrate that with proper maintenance of forces a rotor can become more stable as speed, power and gas density increase (Moore and Hill, 2000). The industry certainly has come a long way in understanding the forces exerted on a rotor since the famous Ekofisk field rotor instability in the North Sea in 1974.

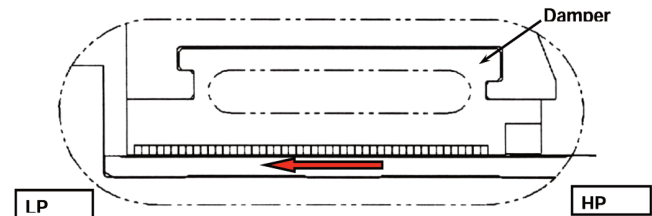

Figure 19. Hole Pattern Seal.

#### Impeller Analysis

More recent advances in structural dynamics have also occurred. One such area that has greatly improved machine reliability is impeller dynamics. In the early years a designer may have run a simple hand calculation to ensure that impeller stresses were such that the impeller did not yield or slip on the shaft. This was sufficient when the impeller tips speeds may have been 50 percent or today's current state-of-the-art. As finite element analysis (FEA) and computer technology advanced, more complicated FEA models were able to better assess the stress exerted on an impeller due to rotation. Nevertheless, most compressor users endured the occasional impeller incident. In many of the instances the failure may have been a result of a high cycle fatigue crack that resulted from an impeller running in a resonance condition. Today, impellers are analyzed using modal and forced response analysis in much the same way as rotors have been for four decades.

Understanding impellers natural frequencies and the aerodynamic forces exerted on these impellers from IGVs and LSDs have greatly reduced the number of impeller-related incidents in recent years (Schiffer and Syed, 2006).

#### LOOKING FORWARD

As noted in the "INTRODUCTION" section, centrifugal compressor technology is rapidly approaching a limit in peak aerodynamic efficiency. However, there are further improvements that can be made to achieve higher efficiency and to broaden the flow range over which that peak efficiency occurs. So, in looking forward at what is to come, one can expect to see more sophisticated impeller blade shapes; more exotic diffusers; movable geometry in guide vanes, diffusers, and return channels; improved seal technologies; and further enhancements in other stationary components. All of these will depend heavily on further advancement in the aerodynamic and mechanical analysis tools providing more accurate simulations of the real world in the computational domain.

More sophisticated impeller blade shapes will include blades that are more customized to address shortcomings discovered using the analytical techniques discussed in the following section. Further, as end users push to handle large flows in small equipment, OEMs will need to develop mixed flow style impellers. Such wheels have been used in single-stage pipeline boosters for many years but are not routine in multistage equipment. Yet this style of impeller represents the most suitable option for flow coefficients above 0.17 to 0.18 in centrifugal compressors.

More exotic diffusers will include more sophisticated vane shapes as well as tandem diffusers, i.e., multiple rows of LSDs or combinations of rib diffusers and LSDs. These will increase the static pressure recovery in the diffuser, leading to an increase in overall stage and compressor efficiency. However, these efficiency

increases will have to be weighed against the probable decreases in operating range that will result.

Improved seal technology will be very important to low-flow coefficient stages. The impeller eye seal leakage represents a significant loss in such stages so anything that can be done to reduce that leakage will improve the efficiency of the stage. Improved technologies such as brush seals, abrasable materials, spring-loaded seals and “directed leakage” will play a greater role in low flow stages.

Regarding external seals, the next logical step in compressor evolution will be the sealless or hermetically-sealed compressor in which there are no rotating shaft seals exposed to the atmosphere. Such machines are, in fact, very similar to the compressors found in common home refrigerators/freezers. Nearly all major compressor OEMs have introduced this new type of product configuration to the marketplace. With increased concerns over emissions, this new style of compressor will become more widely accepted in the oil and gas industry.

Stationary components such as inlet guide vanes and return channels will benefit from more advanced vane shapes (i.e., 3-D vaned diffusers or return channel vanes) or multiblade row configurations designed via the advanced analytical and design tools available today.

Finally, the use of movable geometry in guide vanes, diffusers, and other stationary components will provide OEMs and end users with the opportunity to tune centrifugal stages to the application requirements. Consequently, while it might not be possible to increase the overall peak efficiency of the compressor, it will be feasible to increase the efficiency at off-design operating conditions. This can provide significant savings for the end user who wishes to operate their equipment over a very wide flow range. Movable geometry has been used for years in integrally-gear centrifugal compressors and axial compressors because of the ease of access to the inlet guide vanes and diffusers (Dresser-Roots Co., 2006). For similar reasons, movable geometry in the first stage inlet guide vanes and vaned diffuser of multistage beam-style centrifugal compressors dates back to the 1950s (Ferrara, et al., 2005; Sorokes and Welch, 1992). However, only recently has movable geometry been considered for all stages of a beam-style machine, as seen in Figure 20 (Sorokes, et al., 2009). The complexities of implementing the movable geometry system in the limited stage spacing of a multistage machine make it impractical, yet the performance benefits of doing so might make it too attractive to ignore.

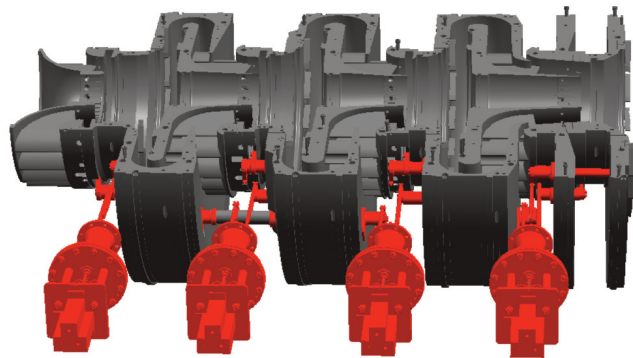

Figure 20. Movable Geometry in Multistage Centrifugal Compressor.

## CLOSING REMARKS

Tremendous advances have been made in the design and manufacturing of industrial centrifugal compressors. Many of these can be traced to the evolution of the analytical tools used in the design process. However, the sophisticated analytical methods would be a waste of effort as it was not possible to build the complex designs conceived by today's engineers. Therefore, one must recognize the critical role that improved manufacturing methods played in the advancement of centrifugal compressor performance. There is little value in designing a new component to the third

decimal place if the manufacturing method cannot even assure accuracy to the first decimal place. Consequently, replacing 3-piece welding with 5-axis machining, switching from castings to machined fabrications, and the like has clearly contributed to higher quality components that, in turn, provide higher performance.

In closing, the industry has not reached the end of the evolutionary process for centrifugal turbomachinery. Further improvements can be achieved and with the ever-increasing demand for more energy efficiency equipment, OEMs will continue to strive for still higher performance levels and/or broader performance maps. It will be indeed be fascinating to watch the evolution of the next generation centrifugal compressor. To be continued...

## NOMENCLATURE

$$\phi = \text{Flow coefficient} = 700.16 \frac{Q}{ND_2^3}$$

$D_2$  = Impeller exit diameter in inches

$N$  = Speed in rotations per minute

$Q$  = Flow in cubic feet per minute

## REFERENCES

- Amineni, N., Engeda, A., Hohlweg, W., and Boal, C., 1995, “Flow Phenomena in Low Solidity Vane Diffusers of an Air Packaging Compressor,” ASME Paper No. 95-WA/PID-1.
- Amineni, N., Engeda, A., Hohlweg, W., and Direnzi, G., 1996, “Performance of Low Solidity and Conventional Diffuser Systems for Centrifugal Compressors,” ASME Paper No. 96-GT-155.
- API 617, 2002, “Axial and Centrifugal Compressors for Petroleum, Chemical, and Gas Industry Services,” Seventh Edition, American Petroleum Institute, Washington, D.C.
- Aungier, R. H., 2000, *Centrifugal Compressors*, ASME Press.
- Bolland, O. and Veer, T., 2003, “Centenary of the First Gas Turbine to Give Net Power Output: A Tribute to Ægidius Elling,” Presentation without Paper, ASME/IGTI TurboExpo Conference 2003, Atlanta, Georgia.
- Booth, D., 1975, “Phillips’ Landmark Injection Project,” *Petroleum Engineering*, pp. 105-109a, Oklahoma.
- Childs, D., 1993, *Turbomachinery Rotordynamics—Phenomena, Modeling, & Analysis*, John Wiley and Sons, Inc.
- Childs, D. W. and Wade, J., October 2003, “Rotordynamic-Coefficient and Leakage Characteristics for Hole-Pattern-Stator Annual Gas Seals-Measurements Versus Predictions,” ASME Paper 2003-TRIB-211, *Proceedings of 2003 STLE/ASME Joint International Tribology Conference*, Ponte Vedra Beach, Florida.
- De Santiago, O. and Memmott, E. A., October 2007, “A Classical Sleeve Bearing Instability in an Overhung Compressor,” CMVA, *Proceedings of the 25<sup>th</sup> Machinery Dynamics Seminar*, St. John, NB.
- Dresser-Roots Company, 2006, “Roots IGC®—Integral Geared Compressor,” Specifications Sheet # S-IGCHouston, Texas.
- Ferrara, G., Ferrari, L., and Baldassarre, L., 2005, “Adaptive Vaned Diffuser for Centrifugal Compressor,” *Proceedings of GT2005, ASME Turbo Expo 2005*, Reno, Nevada.
- Fowlie, D. W. and Miles, D. D., September 1975, “Vibration Problems with High Pressure Centrifugal Compressors,” Petroleum Mechanical Engineering Conference, Tulsa, Oklahoma.
- Hustak, J. F., Kirk, R. G., and Shoeneck, K. A., May 1986, “Analysis and Test Results of Turbocompressors Using Active Magnetic Bearings,” 43, (5), pp. 356-362, *Lubrication Engineering*, ASLE 41st Annual Meeting, Toronto, Ontario, Canada.
- Japikse, D. and Baines, N., 1994, *Introduction to Turbomachinery*, Concepts ETI, Inc. and Oxford University Press.

- Kirk, R. G., September 1986, "Labyrinth Seal Analysis for Centrifugal Compressor Design—Theory and Practice," *Proceedings of the International Conference on Rotordynamics*, Tokyo, Japan, pp. 589-596.
- Kirk R. G. and Miller, W. H., October 1977, "The Influence of High Pressure Oil Seals on Turbo-Rotor Stability," ASLE/ASME Lubrication Conference Kansas City, Missouri.
- Kleynhans, G. F. and Childs, D. W., June 1996, "The Acoustic Influence of Cell Depth on the Rotordynamic Characteristics of Smooth-Rotor/Honeycomb-Stator Annular Gas Seals," ASME International Gas Turbine and Aeroengine Congress and Exposition, Birmingham, United Kingdom.
- Kuzdzal, M. J., Hustak, J. F., and Sorokes, J. M., September 1994, "Identification and Resolution of Aerodynamically Induced Subsynchronous Vibration During Hydrocarbon Testing of a 34,000 HP Centrifugal Compressor," IFToMM, *Proceedings of the 4th International Conference on Rotordynamics*, Chicago, Illinois.
- Lund, J. W., 1964, "Spring and Damping Coefficients for the Tilting-Pad Journal Bearing," ASLE Transactions, 7, pp. 342-352.
- Lund, J. W., May 1965, "Rotor-Bearing Dynamics Design Technology, Part V: Computer Program Manual for Rotor Response and Stability," *Technical Report AFAPL-TR-65-45, Part V*, Air Force Aero Propulsion Laboratory, Wright-Patterson Air Force Base, Dayton, Ohio.
- Lund, J. W., 1974, "Stability and Damped Critical Speeds of a Flexible Rotor in Fluid-Film Bearings," Trans. ASME, *Journal of Engineering for Industry*, pp. 509-517.
- Lund, J. W., and Orcutt, F. K., November 1967, "Calculations and Experiments on the Unbalance Response of a Flexible Rotor," Trans. ASME, *Journal of Engineering for Industry*, pp. 785-796.
- Marshall, D. F. and Sorokes, J. M., 2000, "A Review of Aerodynamically Induced Forces Acting on Centrifugal Compressors, and Resulting Vibration Characteristics of Rotors," *Proceedings of the Twenty-Ninth Turbomachinery Symposium*, Turbomachinery Laboratory, Texas A&M University, College Station, Texas, pp. 263-280.
- Memcott, E. A., September 1990, "Tilt Pad Seal and Damper Bearing Applications to High Speed and High Density Centrifugal Compressors," IFToMM, *Proceedings of the 3rd International Conference on Rotordynamics*, Lyon, France, pp. 585-590.
- Memcott, E. A., September 1992, "Stability of Centrifugal Compressors by Applications of Tilt Pad Seals, Damper Bearings, and Shunt Holes," IMechE, 5th International Conference on Vibrations in Rotating Machinery, Bath, United Kingdom, pp. 99-106.
- Memcott, E. A., September 2004, "The Stability of Centrifugal Compressors by Applications of Tilt Pad Seals," IMechE, 8th International Conference on Vibrations in Rotating Machinery, Swansea, United Kingdom, pp. 81-90.
- Miller, H. F., Liu, E. J., Myers, L. W., and Vitale, D. D., 1996, "Ebrace Weld Process Development," Dresser-Rand Technology Journal, 2.
- Moore, J. J. and Hill, D. L., March 2000, "Design of Swirl Brakes for High Pressure Centrifugal Compressors Using CFD Techniques," 8th International Symposium on Transport Phenomena and Rotating Machinery, ISROMAC-8, II, Honolulu, Hawaii, pp. 1124-1132.
- Myklestad, N. O., 1944, "A New Method for Calculating Natural Modes of Uncoupled Bending Vibrations of Airplane Wings and Other Beams," *Journal of Aeronautical Sciences*, 11, pp. 153-162.
- Newkirk, B. L., July 1956, "Varieties of Shaft Disturbances Due to Fluid Films in Journal Bearings," Trans. ASME, pp. 985-988.
- Nicholas, J. C., 1985, "Stability, Load Capacity, Stiffness and Damping Advantages of the Double Pocket Journal Bearing," *ASME Journal of Tribology*, 107, (1), pp. 53-58.
- Nicholas, J. C. and Allaire, P. E., 1980, "Analysis of Step Journal Bearings—Finite Length, Stability," *ASLE Transactions*, 23, (2), pp. 197-207.
- Nicholas, J. C. and Kirk R. G., 1981, "Theory and Application of Multi-Pocket Bearings for Optimum Turborotor Stability," *ASLE Transactions*, 24, (2), pp. 269-275.
- Nicholas, J. C., Gunter, E. J., and Allaire, P. E., April 1979, "Stiffness and Damping Coefficients for the Five-Pad Tilting-Pad Bearing," *ASLE Transactions*, 22, (2), pp. 113-124.
- Osborne, C. and Sorokes, J. M., 1988, "The Application of Low Solidity Diffusers in Centrifugal Compressors," *Flows in Non-Rotating Turbomachinery Components*, ASME FED 69.
- Pinkus, O., July 1956, "Experimental Investigation of Resonant Whip," Trans. ASME, pp. 975-983.
- Prohl, M. A., September 1945, "A General Method for Calculating Critical Speeds of Flexible Rotors," Trans. ASME, *Journal of Applied Mechanics*, pp. A-142 - A-148 .
- Ramesh, K., October 2004, "Introduction to Rotor Dynamics: A Physical Interpretation of the Principles and Application of Rotor Dynamics," GMRC 2004, Albuquerque, New Mexico.
- Schiffer, D. M. and Syed, A., 2006, "An Impeller Dynamic Risk Assessment Toolkit," *Proceedings of the Thirty-Fifth Turbomachinery Symposium*, Turbomachinery Laboratory, Texas A&M University, College Station, Texas, pp. 49-54.
- Senoo, Y., Hayami, H., and Ueki, H., 1983, "Low-Solidity Tandem-Cascade Diffusers for Wide Flow Range Centrifugal Blowers," ASME Paper No. 83-GT-3.
- Shepherd, D. G., 1956, *Principles of Turbomachinery*, MacMillan Publishing Co.
- Smalley, A. J., Almstead, L. G., Lund, J. W., and Koch, E. S., 1974, "User's Manual—MTI Cadense Program CAD-25—Dynamic Stability of a Flexible Rotor," Mechanical Technology Inc.
- Smith, K. J., 1975, "An Operational History of Fractional Frequency Whirl," *Proceedings of the Fourth Turbomachinery Symposium*, Turbomachinery Laboratory, Texas A&M University, College Station, Texas, pp. 115-125.
- Sorokes, J. M., 1995, "Industrial Centrifugal Compressors—Design Considerations," ASME Paper No. 95-WA/PID-2
- Sorokes, J. M., 2003, "Range Versus Efficiency—A Dilemma for Compressor Designers and Users," ASME Paper No. IMECE2003-55223.
- Sorokes, J. M. and Kopko, J. A., 2001, "Analytical and Test Experiences Using a Rib Diffuser in a High Flow Centrifugal Compressor Stage," ASME Paper 2001-GT-320.
- Sorokes, J. M. and Kopko, J. A., 2007, "High Inlet Relative Mach Number Centrifugal Impeller Design," ASME GT2007-27864.
- Sorokes, J. M. and Welch, J. P., 1992, "Experimental Results on a Rotatable Low Solidity Vaned Diffuser," ASME Paper 92-GT-19, *Proceedings of the 1992 International Gas Turbine and Aeroengine Congress and Exposition*, Cologne, Germany.
- Sorokes, J. M., Soulas, T. A., Koch, J. M., 2009. "Full-Scale Aerodynamic and Rotordynamic Testing for Large Centrifugal Compressors," *Proceedings of the Thirty-Eighth Turbomachinery Symposium*, Turbomachinery Laboratory, Texas A&M University, College Station, Texas, pp. 71-80.

- Stahley, J. S., 2005, *Dry Gas Seals Handbook*, PennWell Corp.
- Wachel, J. C., 1975, "Nonsynchronous Instability of Centrifugal Compressors," Petroleum Mechanical Engineering Conference, Tulsa, Oklahoma.

#### BIBLIOGRAPHY

- Bloch, H., 2006, *A Practical Guide to Compressor Technology*, Wiley.
- Cumpsty, N. A., 1989, *Compressor Aerodynamics*, Longman Scientific & Technical.
- Gilarranz, J. L., Keesler, J. E., Koch, J. M., Lombardi, L. M., Maier, W. C., and Sorokes, J. M., 2007, "Actuation and Control of a Moveable Geometry System for a Large Frame Size, Multi-Stage Centrifugal Compressor Test Rig," ASME Paper No. GT2007-27592.
- Japikse, D., 1996, *Centrifugal Compressor Design and Performance*, Concepts ETI, Inc.
- Moore, J. J., Walker, S. T., and Kuzdzal, M. J., 2002, "Rotordynamic Stability Measurement During Full-Load, Full-Pressure Testing of a 6000 PSI Reinjection Centrifugal Compressor," *Proceedings of the Thirty-First Turbomachinery Symposium*, Turbomachinery Laboratory, Texas A&M University, College Station, Texas, pp. 29-38.

- Nicholas, J. C., 1996, "Hydrodynamic Journal Bearings—Types, Characteristics and Applications," Mini Course Notes, 20th Annual Meeting, The Vibration Institute, Willowbrook, Illinois.
- Shoeneck, K. A and Hustak, J. F., 1987, "Comparison of Analytical and Field Experience for a Centrifugal Compressor Using Active Magnetic Bearings," IMechE, 3rd European Congress Fluid Machinery for the Oil, Petrochemical and Related Industries, The Hague, Netherlands.

#### ACKNOWLEDGEMENTS

The authors acknowledge the many innovators and risk-takers who advanced the state-of-the-art of centrifugal compressors technology as well as those who developed and championed the sophisticated manufacturing and analytical methods available to today's compressor designers. The authors specifically thank Dr. Edmund Memmott for his help in pulling together material for this paper. Finally, the authors also thank Dresser-Rand for allowing them to publish this work.