

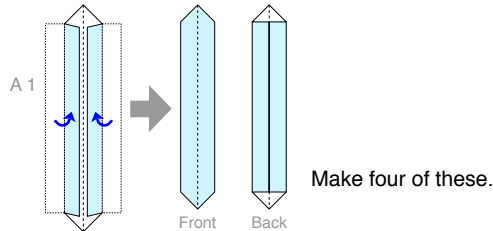

Frame

1) Cut out A1-A5 and assemble each part.

As for A1, fold each side inwardly and glue the back of each side together.



As for A2-A5, fold the upper side inwardly and glue the back of each side together.

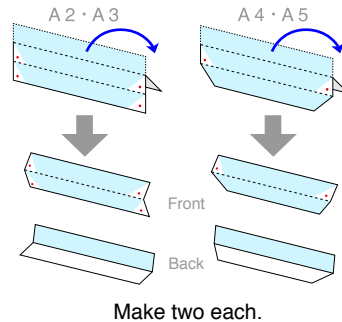

2) Assemble A1-A5.

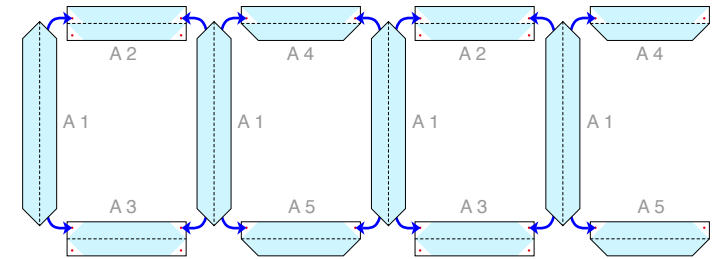

As shown in the diagram, assemble by attaching both ends of A1 to the glue tabs of A2-A5.

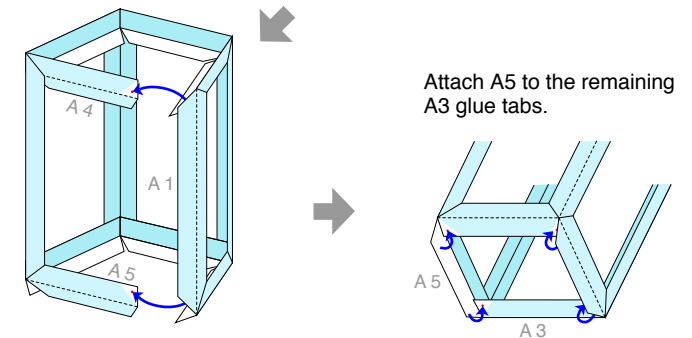

So that it becomes box-shaped, do the same for the ends of A1 and A4/A5.

You will need

Scissors, glue, ruler, a used ball-point pen, white string

Explanation of symbols

- Mountain fold (Dotted line)
- - - - - Valley fold (Dashed and dotted line)
- Cut line (Solid line)
- Cut in line (Red solid line)
- Glue tab
- ✂ Cut out

Assembly tip

Trace along the folds with a ruler and a used pen (no ink) to get a sharper, easier fold.

Caution: This craft requires the use of glue, scissors, and other tools which may be dangerous to young children. Please keep them out of reach of children while you work.

3) Cut out A6-A8 and assemble each part.

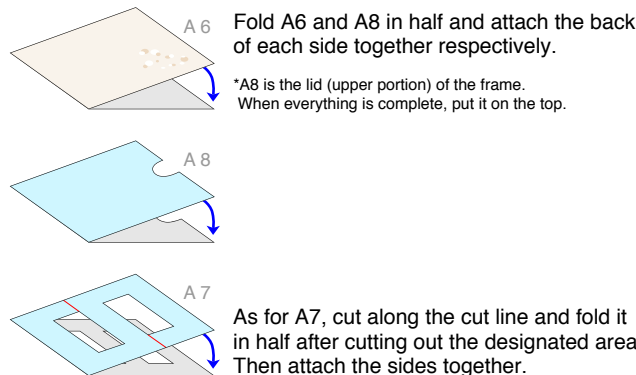

4) Assemble A6 and A7 to the frame you've already completed.

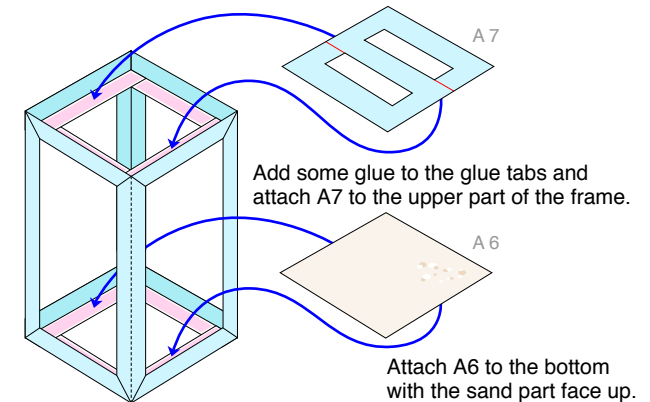

Option 1

1) Cut out B1-B4 and assemble each part.

Fold B1-B3 in half, attach the back of each respective side together, and cut each piece out.

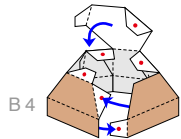

As for B4, start assembly by attaching from the sides. As a final step, put the remaining piece on the top like a lid.

2) Attach B1-B4.

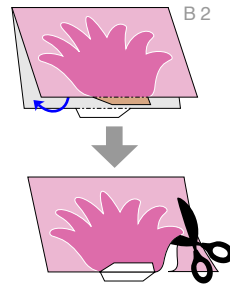
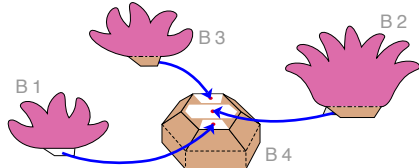

Clown fish

1) Cut out D1 and D2, make incisions, and curve them as indicated by the arrows.

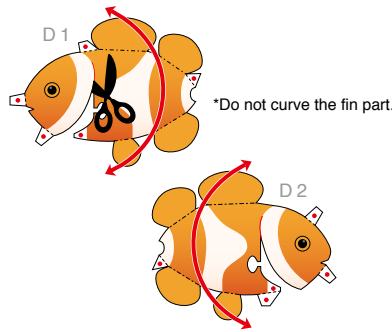

*Do not curve the fin part.

2) Cut out D3-D7 and assemble each part.



Fold D3-D5 in half and attach the back of each side together respectively.



Make a fold on D6.

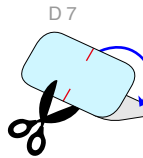

Fold D7 in half, attach the back of each side together, and make incisions.

3) Attach D1-D6.

*Do not attach this part.

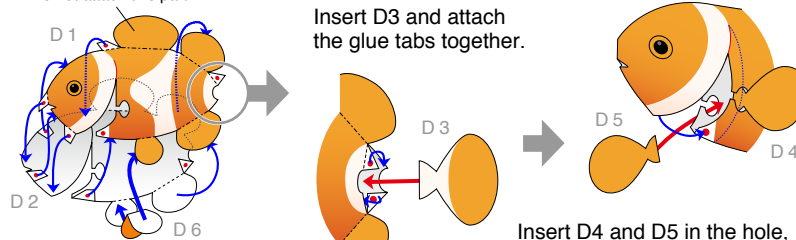

Place D6 between D1 and D2 and attach the back of each respective side together.

Insert D4 and D5 in the hole, pull out the head to hide the front part of the hole, and stabilize it with the glue tab.

4) Attach the string and D7 on the clown fish.

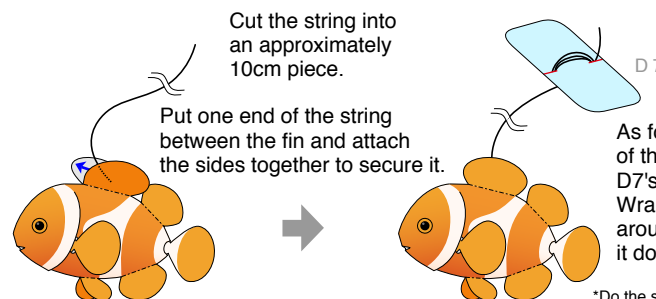

Cut the string into an approximately 10cm piece.

Put one end of the string between the fin and attach the sides together to secure it.

As for the other end of the string, put it in D7's incision. Wrap it several times around D7 so that it doesn't come off.

*Do the same for the other fish.

Finish

1) Wrap the clown fish's string around D7 as many times as you wish to obtain your desired length.

2) Hook the clown fish on the hole found in the upper part of the frame.

3) Arrange Option 1 and Option 2, put the lid (frame A8) on top, and you're done!

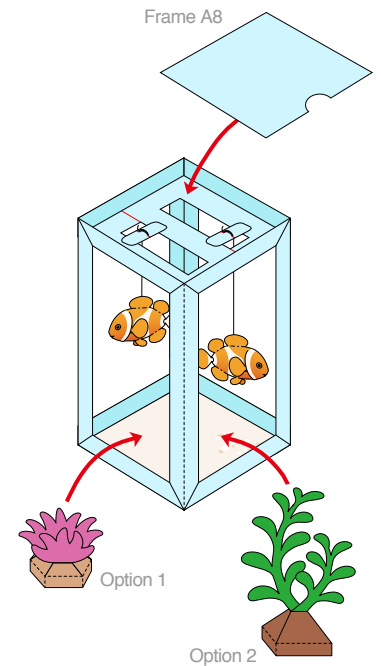

Option 2

1) Cut out C1-C3 and assemble each part.

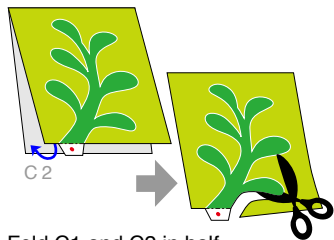

Fold C1 and C2 in half, attach the back of each respective side together, and cut each piece out.

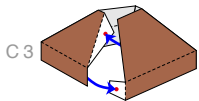

A space will be created on the top of C3.

2) Attach C1-C3.

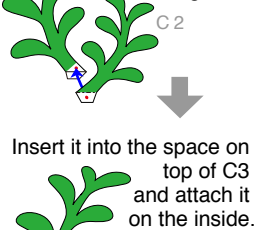
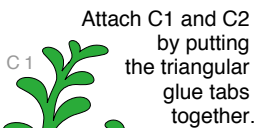

Insert it into the space on top of C3 and attach it on the inside.