

dotlessbeh-ar

066E

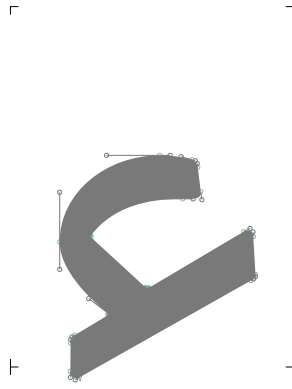

hamza-ar

0621



highhamza-ar

0674

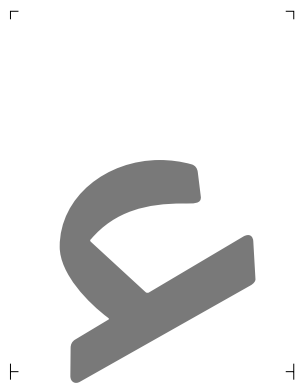

hamza-ar.isol

FE80

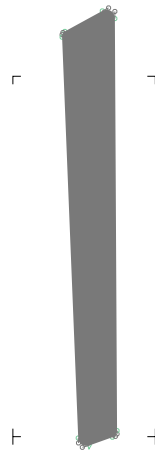

alef-ar

0627

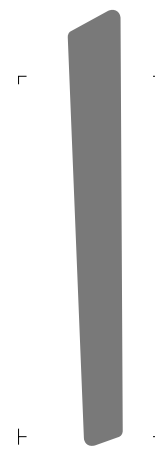

alef-ar.isol

FE8D

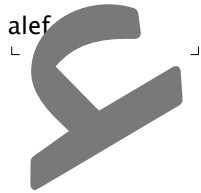
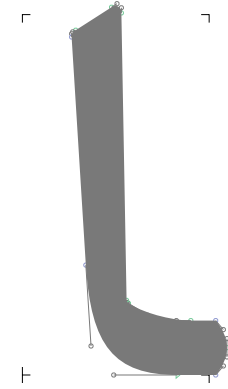
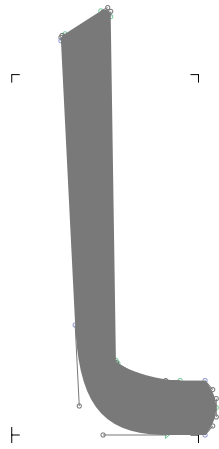

FE8E

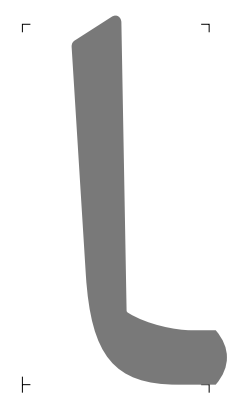

alefHamzaabove-ar

0623

alefHamzaabove-ar.isol

FE83

alefHamzaabove-ar.fina

FE84

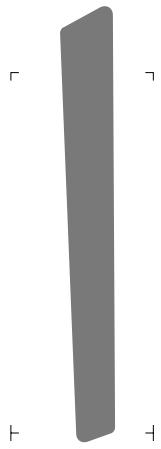

alefHamza-ar

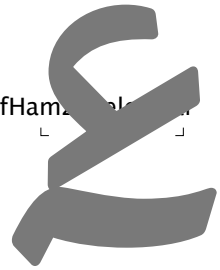

0625

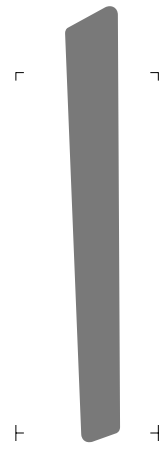

alefHamza-ar.isol



FE87

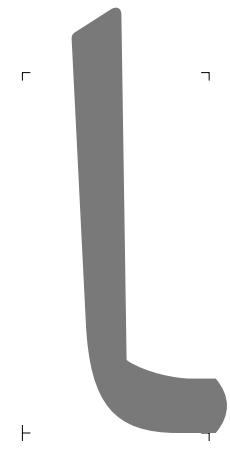

alefHamzabel

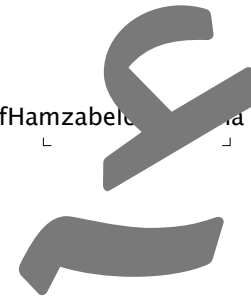

FE88

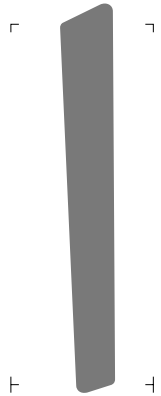

alefMadda-ar

0622

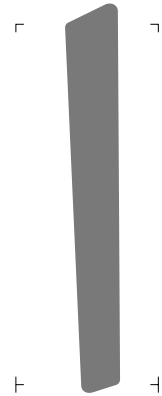

alefMadda-ar.isol

FE81

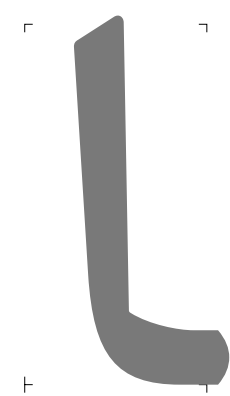

alefMadda-ar.fina

FE82

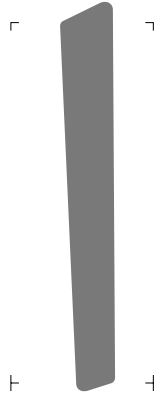

alefWasla-ar

0671

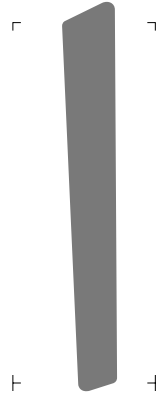

alefWasla-ar.isol

FB50

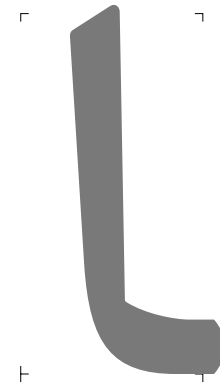

alefWasla-ar.fina

FB51

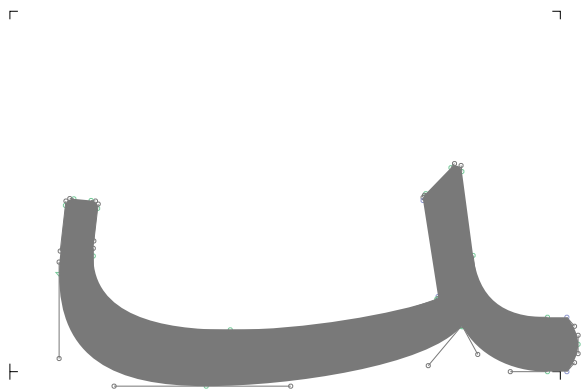

dotlessbeh-ar.fina

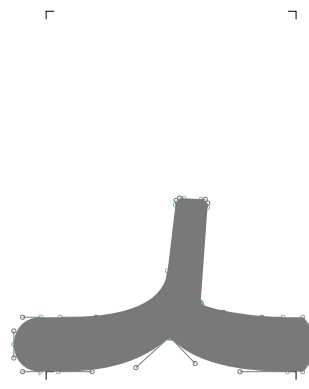

dotlessbeh-ar.medi

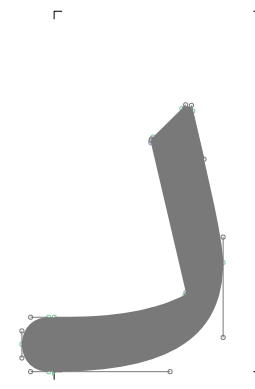

dotlessbeh-ar.init

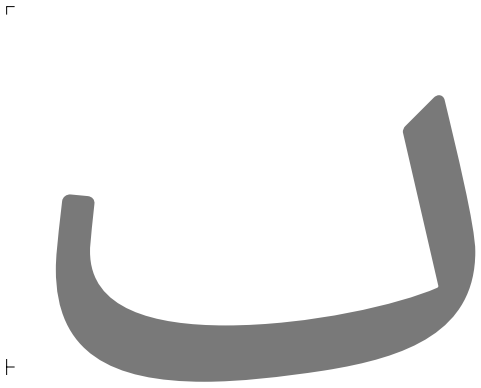

beh-ar

0628

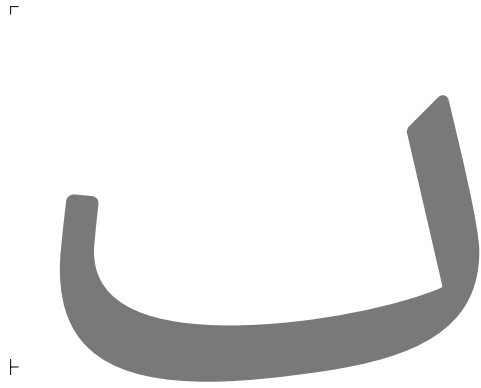

beh-ar.isol

FE8F



beh-ar.fina

FE90

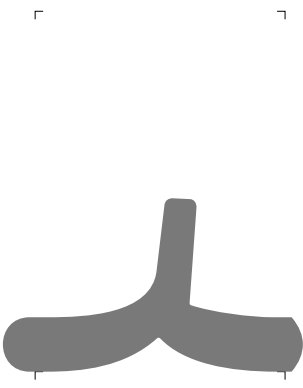

beh-ar.medi

FE92



beh-ar.init

FE91

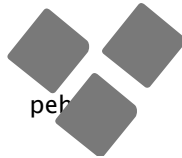
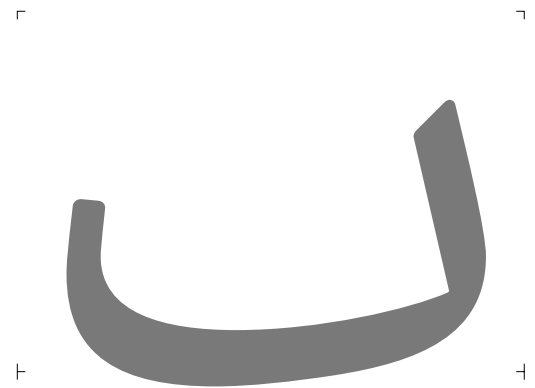

peh

067E

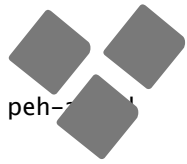
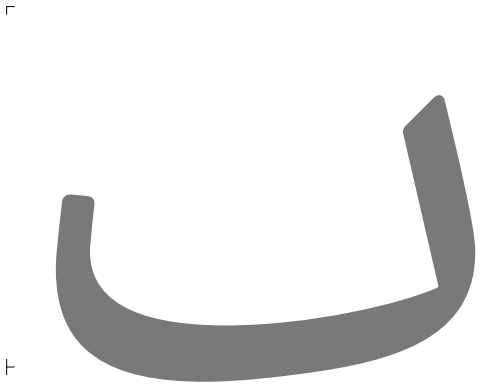

peh

FB56

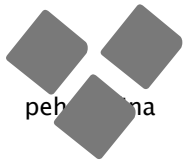

peh na

FB57

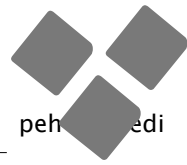
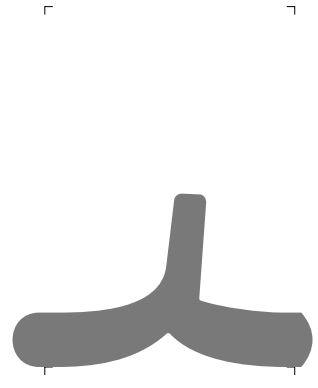

peh medi

FB59

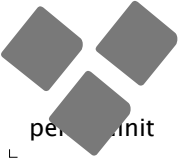

peh init

FB58

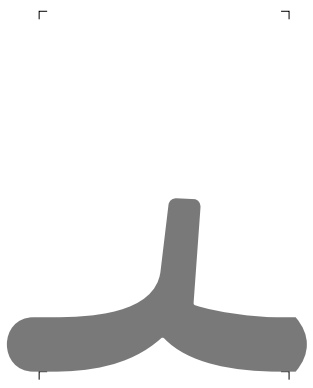

alefMaksura-ar.medi

FBE9

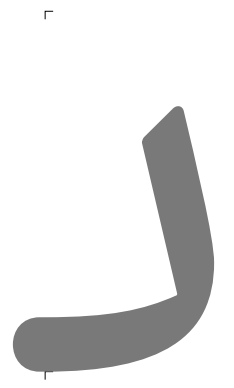

alefMaksura-ar.init

FBE8

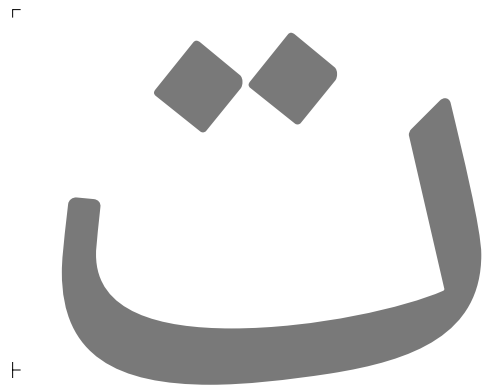

teh-ar

062A

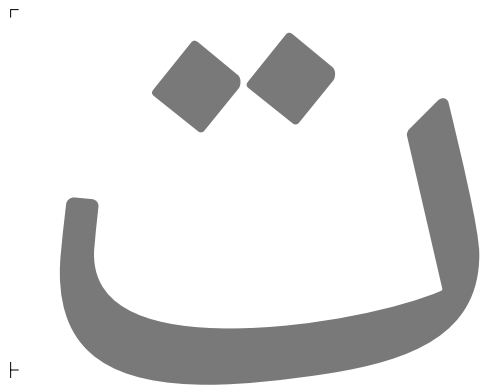

teh-ar.isol

FE95

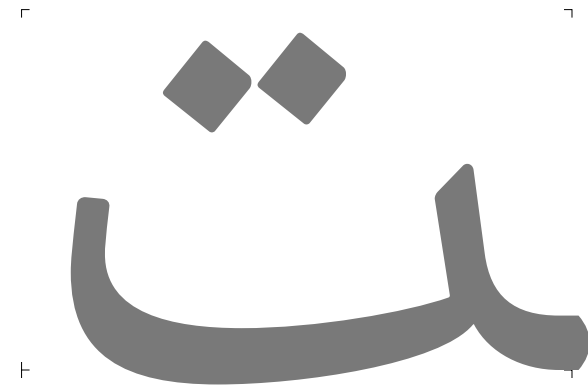

teh-ar.fina

FE96

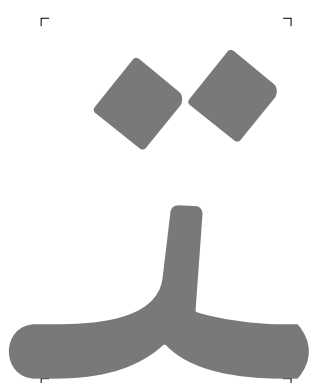

teh-ar.medi

FE98

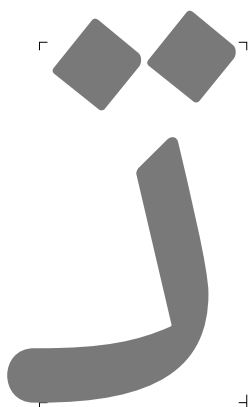

teh-ar.init

FE97



tehRing-ar

067C



tehRing-ar.fina

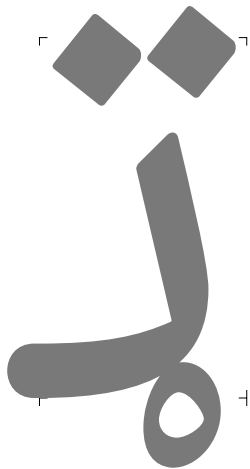

tehRing-ar.init



tehRing-ar.isol

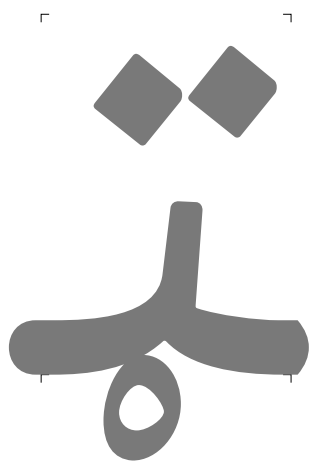

tehRing-ar.medi

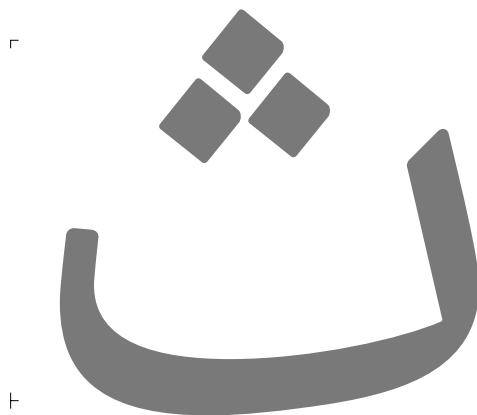

theh-ar

062B

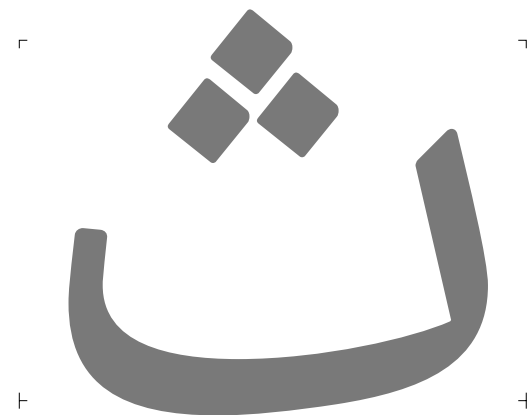

theh-ar.isol

FE99

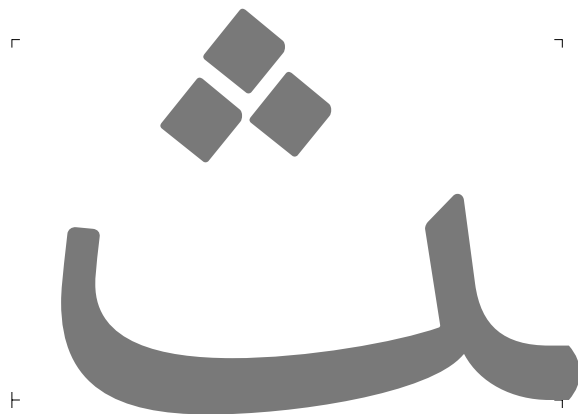

theh-ar.fina

FE9A

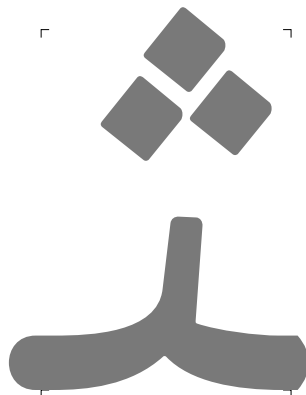

theh-ar.medi

FE9C

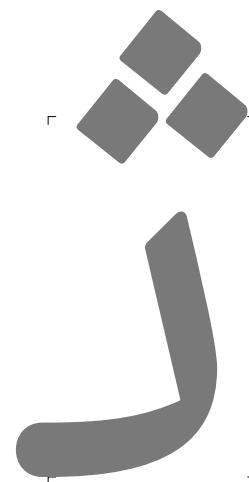

theh-ar.init

FE9B

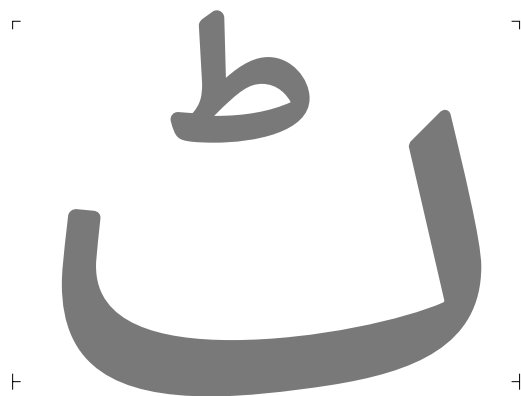

tteh-ar

0679

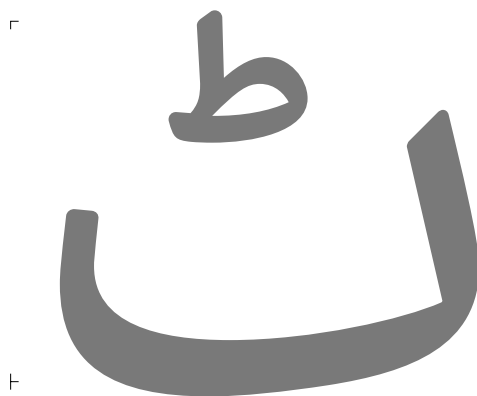

tteh-ar.isol

FB66

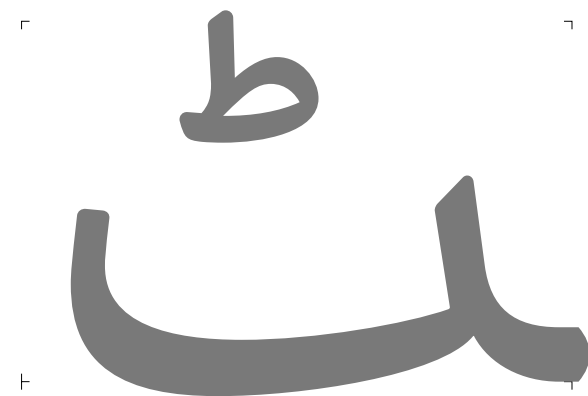

tteh-ar.fina

FB67



tteh-ar.medi

FB69



tteh-ar.init

FB68



062C



FE9D

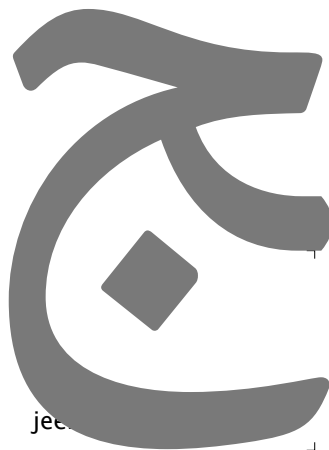

jeem

FE9E

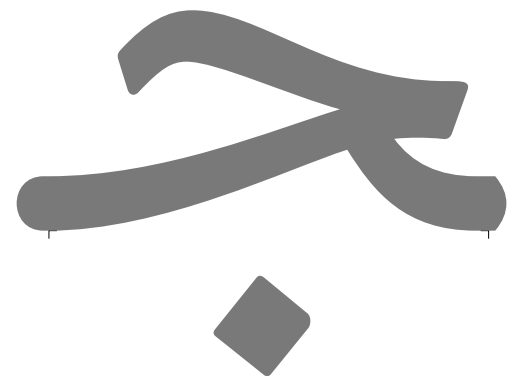

jeem-ar.medi

FEA0

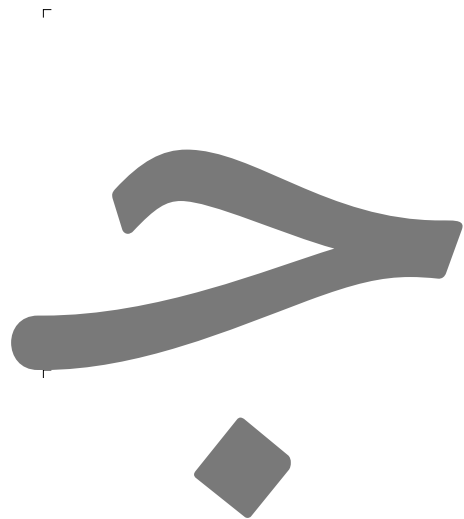

jeem-ar.init

FE9F



0686



FB7A

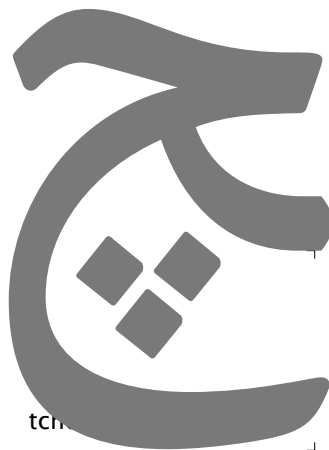

FB7B

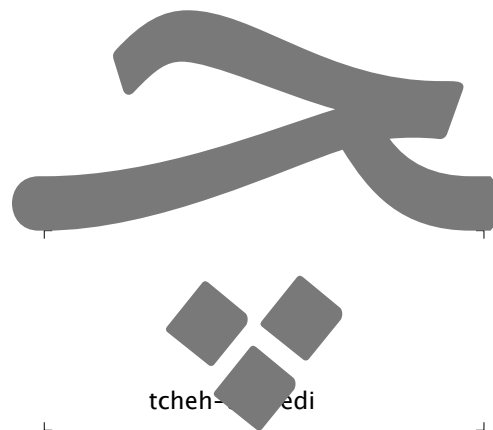

tcheh-edi

FB7D

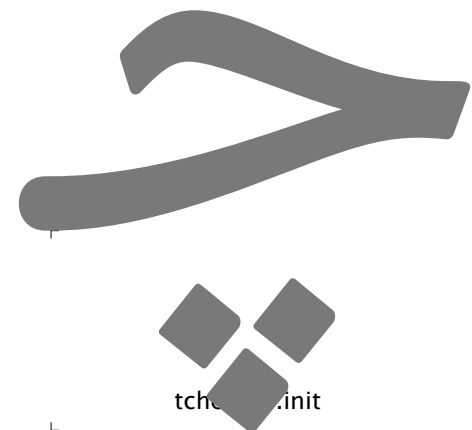

tcheh-init

FB7C

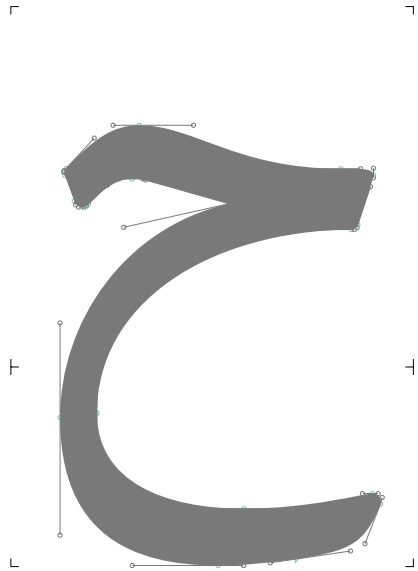

062D

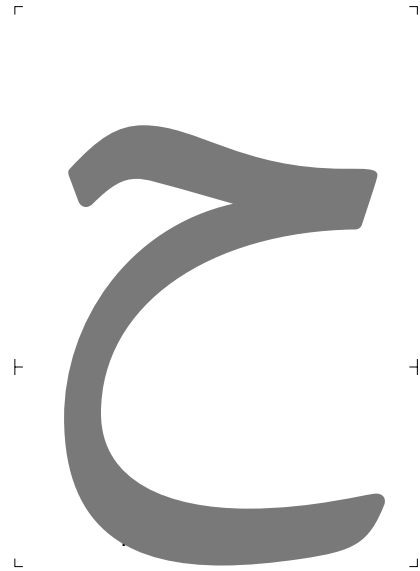

FEA1

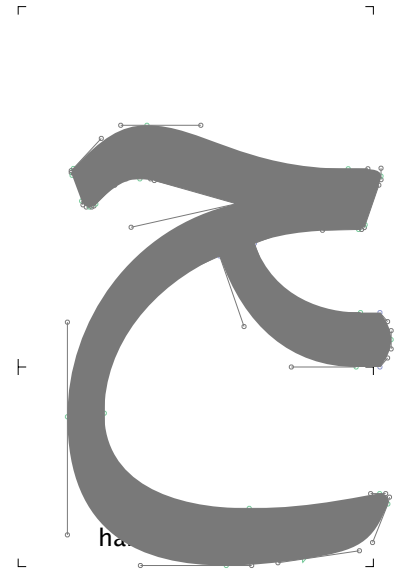

FEA2

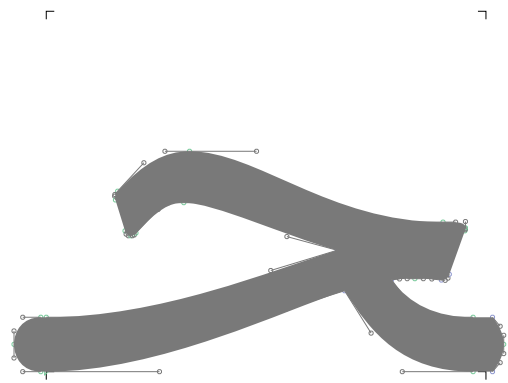

hah-ar.medi

FEA4

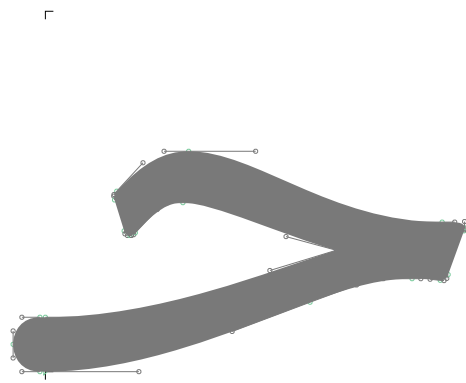

hah-ar.init

FEA3

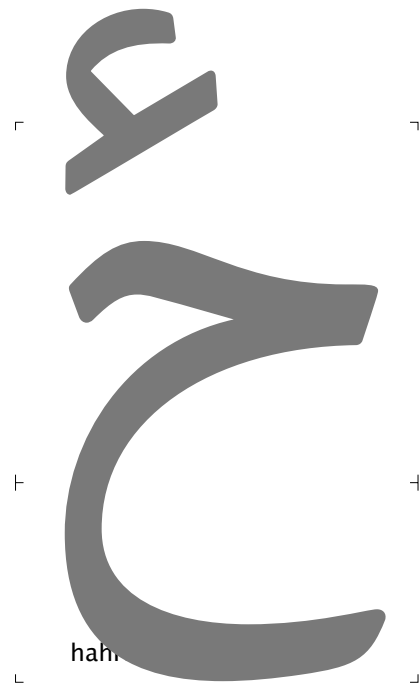

hah

0681

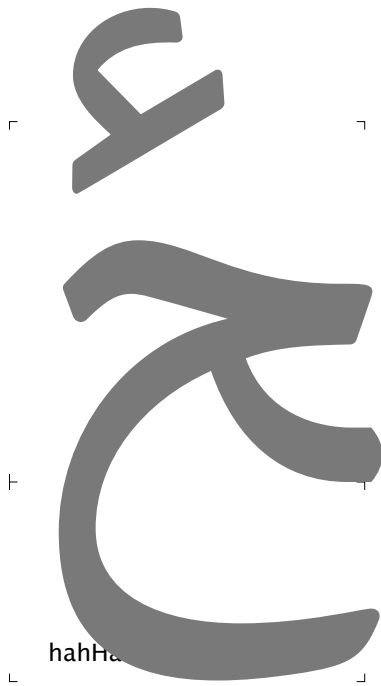

hahHamzaabove

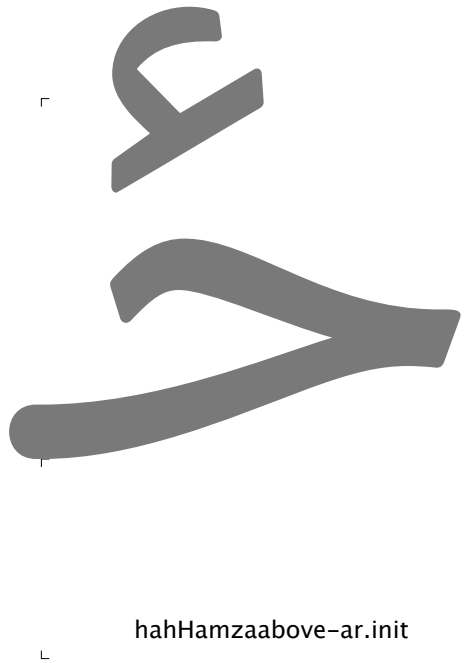

hahHamzaabove-ar.init

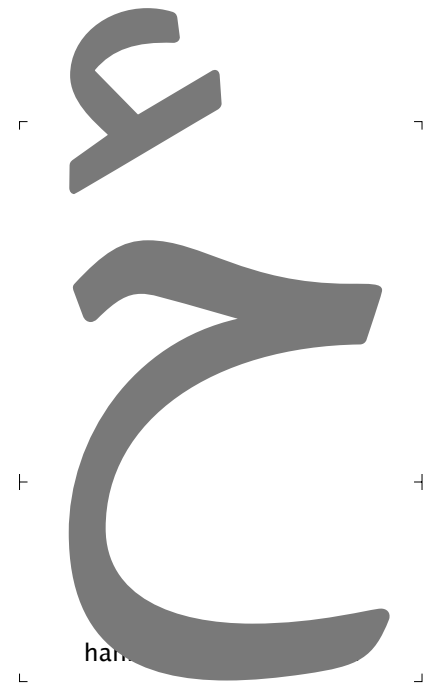

hah

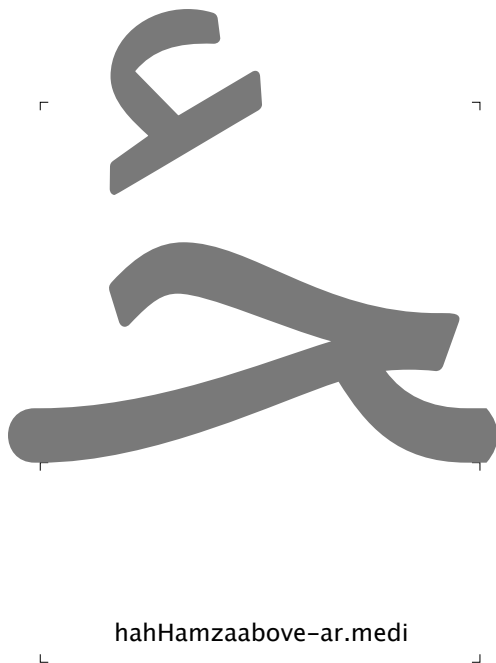

hahHamzaabove-ar.medi

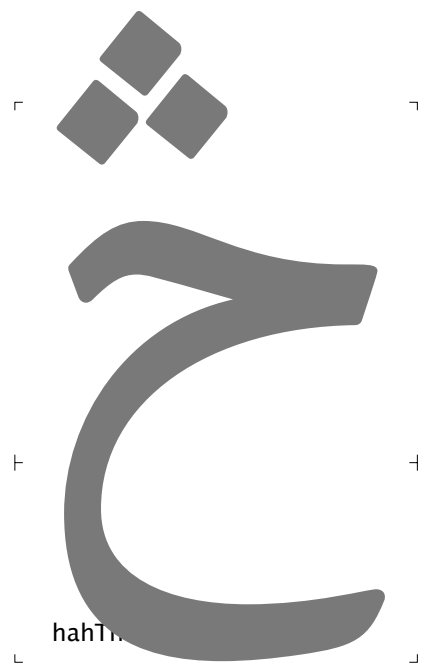

hahTh

0685

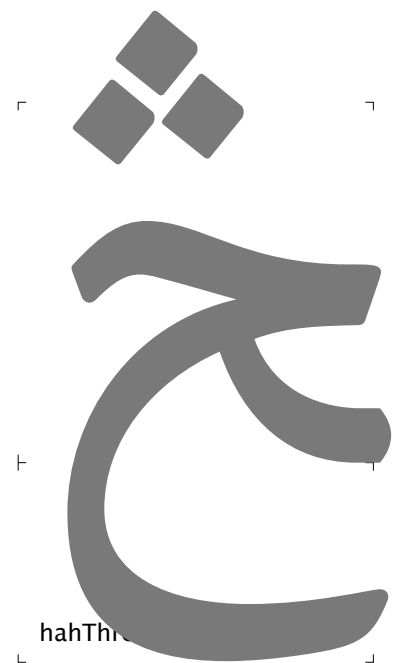

hahTh

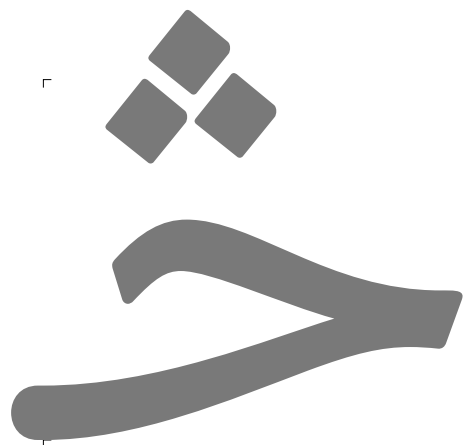

hahThreedotsabove-ar.init

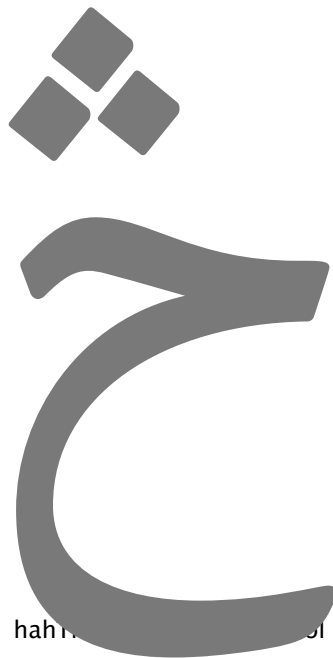

hahThreedotsabove-ar.med

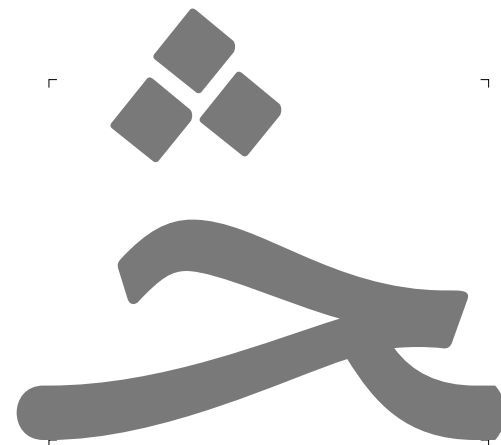

hahThreedotsabove-ar.medi

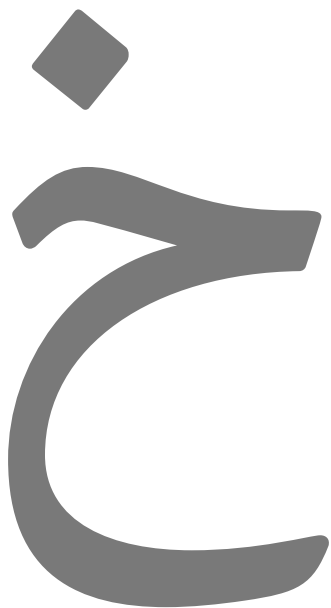

062E

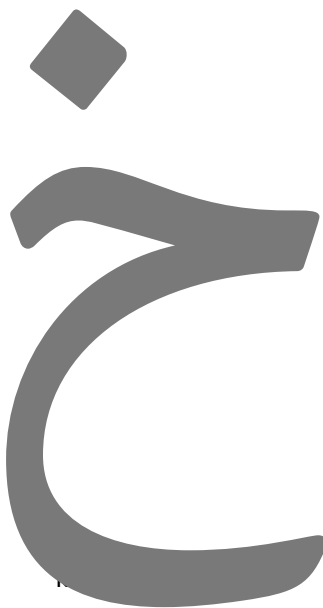

FEA5

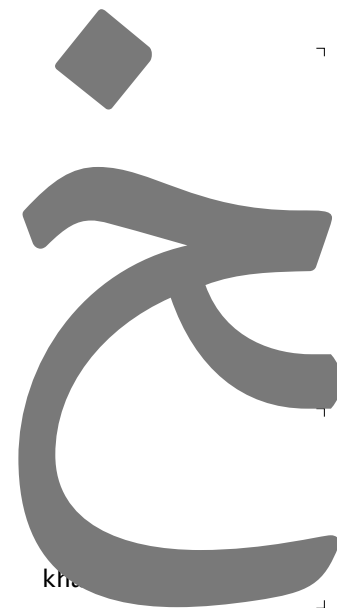

kh

FEA6

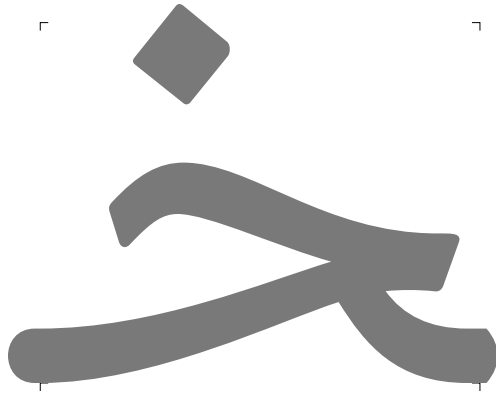

khah-ar.medi

FEA8

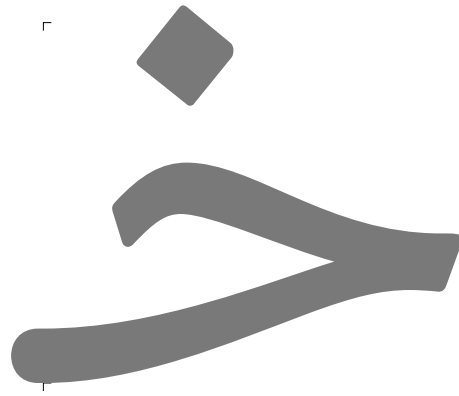

khah-ar.init

FEA7

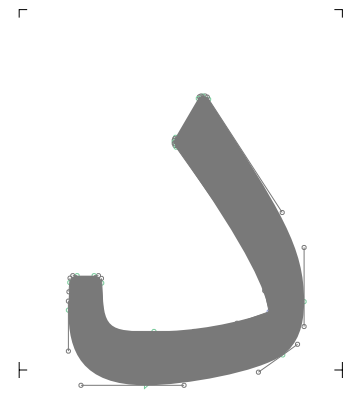

dal-ar

062F

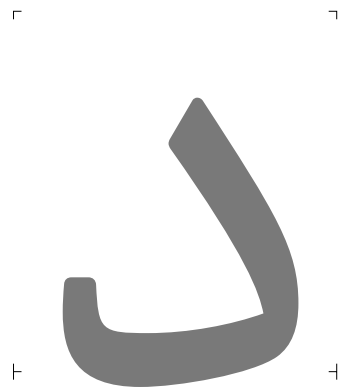

dal-ar.isol

FEA9

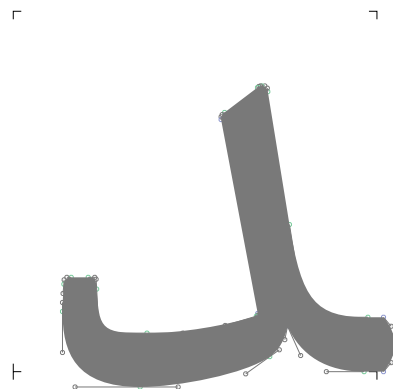

dal-ar.fina

FEAA

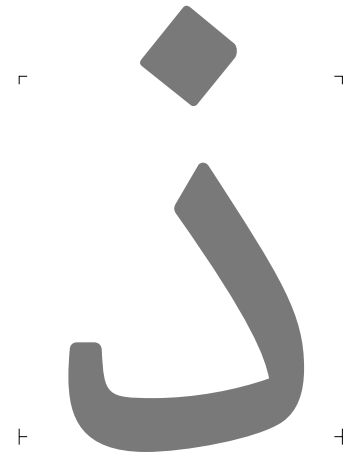

thal-ar

0630

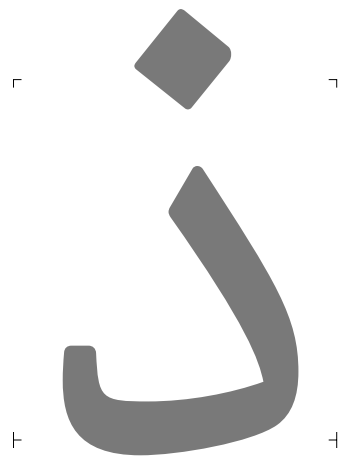

thal-ar.isol

FEAB

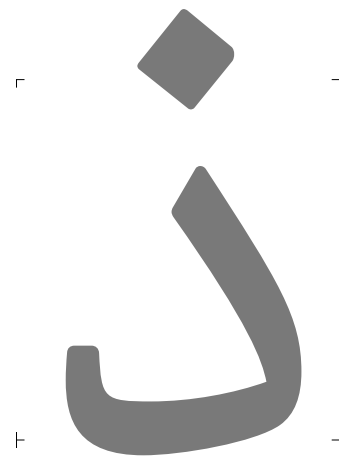

thal-ar.isol.001

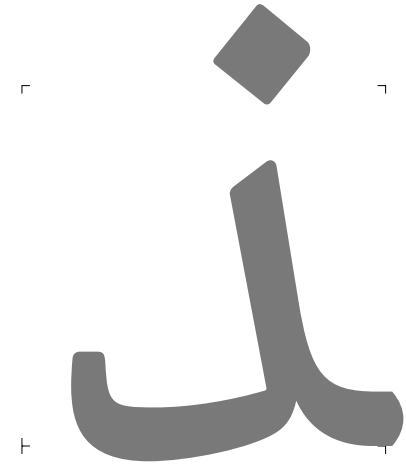

thal-ar.fina

FEAC

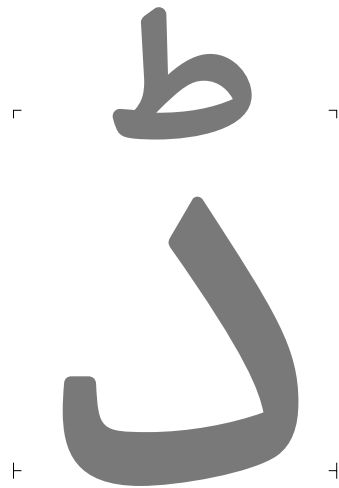

ddal-ar

0688

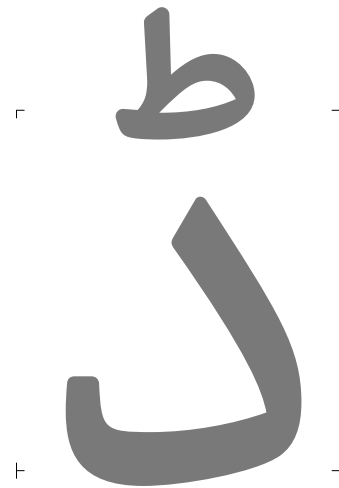

ddal-ar.isol

FB88

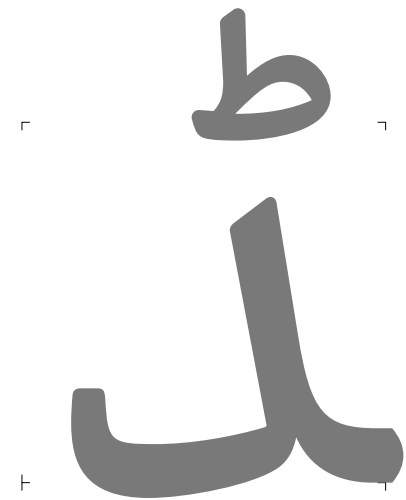

ddal-ar.fina

FB89

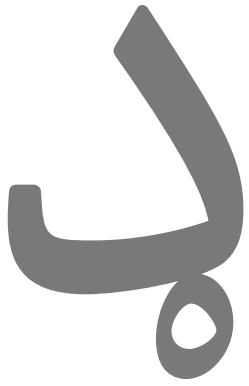

dalRing-ar

0689



dalRing-ar.fina

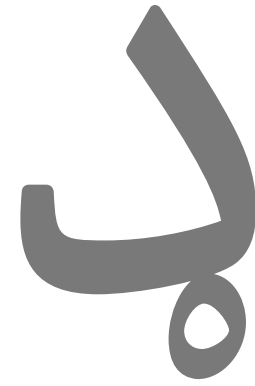

dalRing-ar.isol

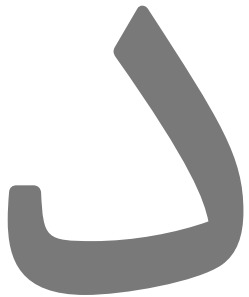

dul-ar

068E

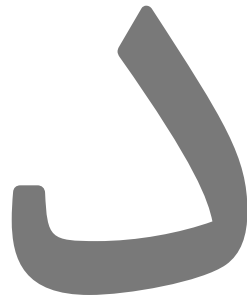

dul-ar.isol

FB86



dul-ar.fina

FB87

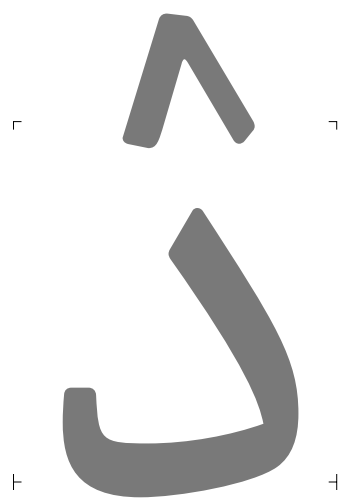

dalV inverted above ar

06EE

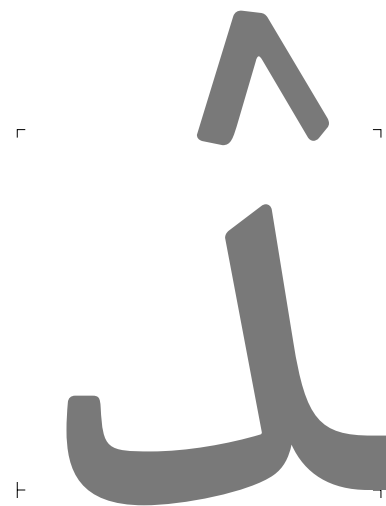

dalV inverted above ar fina

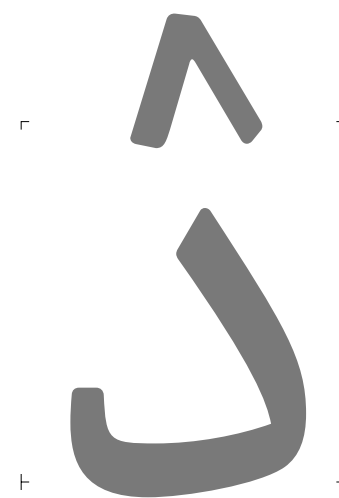

dalV inverted above ar isol

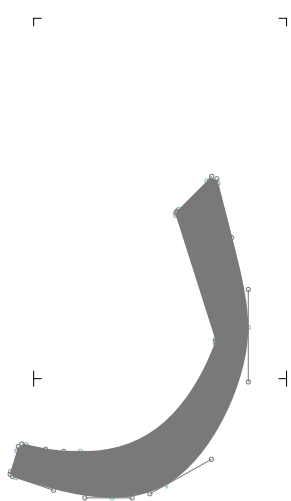

reh ar

0631

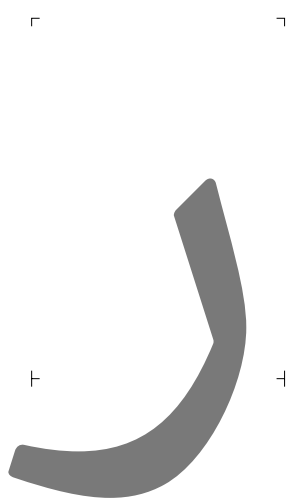

reh ar isol

FEAD

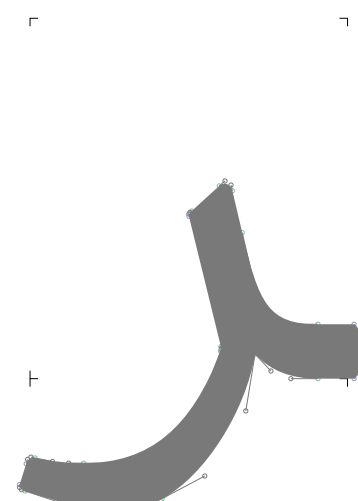

reh ar fina

FEAE

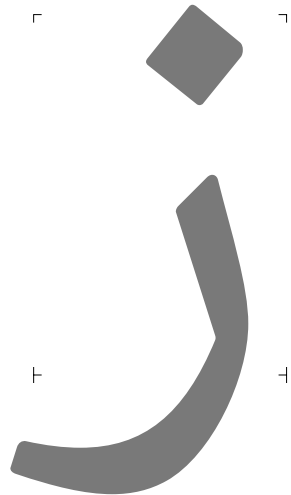

zain-ar

0632

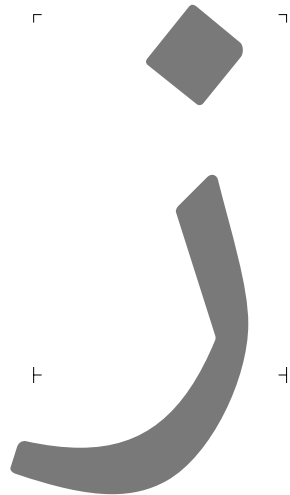

zain-ar.isol

FEAF

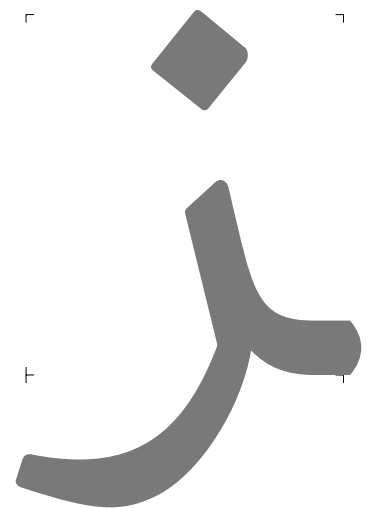

zain-ar.fina

FEBO



rreh-ar

0691



rreh-ar.isol

FB8C

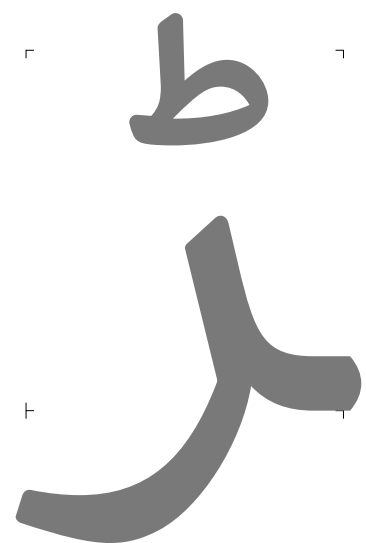

rreh-ar.fina

FB8D

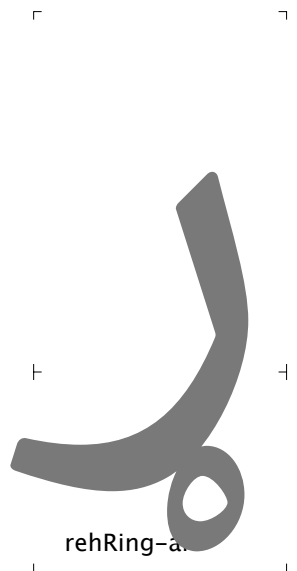

rehRing-ar

0693

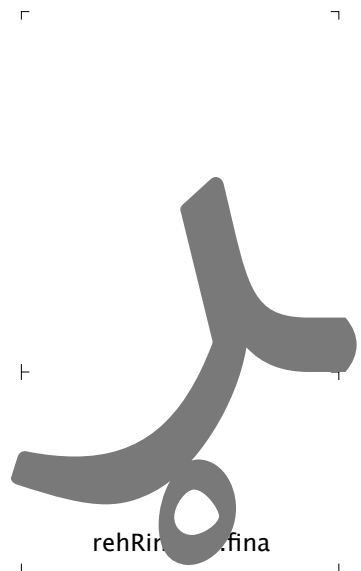

rehRing-ar.fina

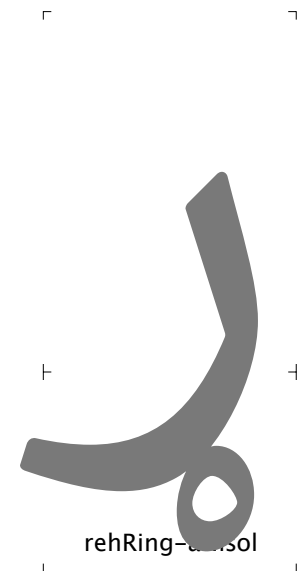

rehRing-ar.isol

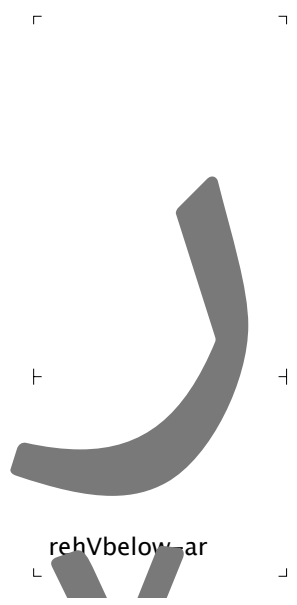

rehVbelow-ar

0695

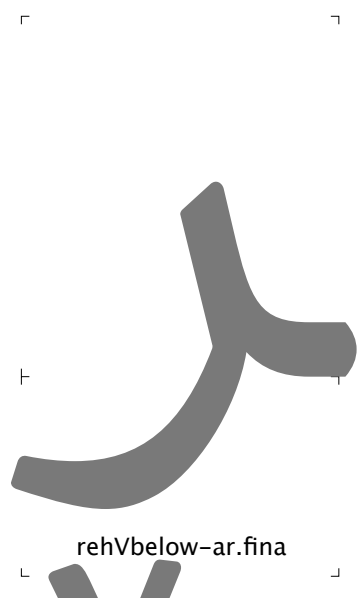

rehVbelow-ar.fina

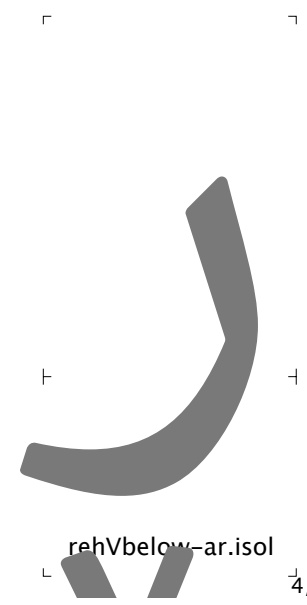

rehVbelow-ar.isol

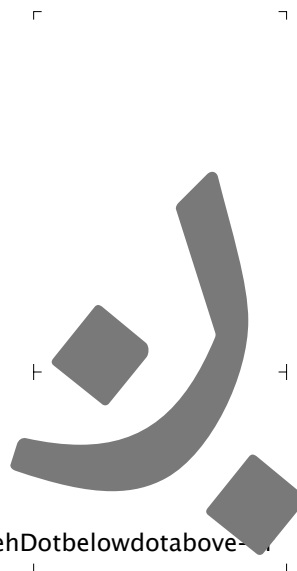

0696

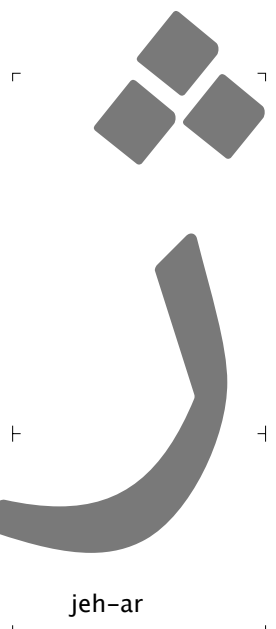
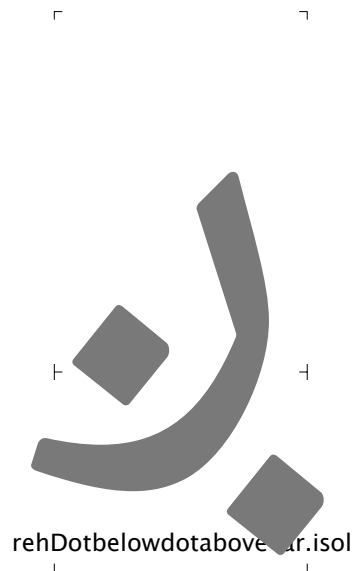
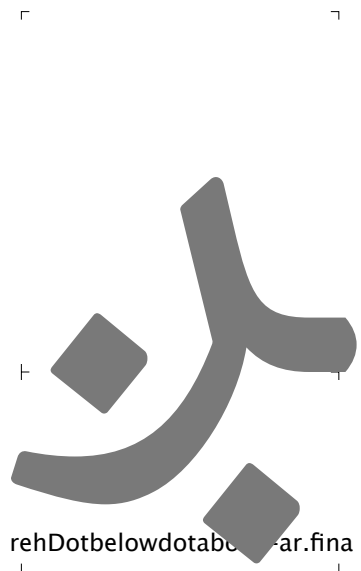

0698

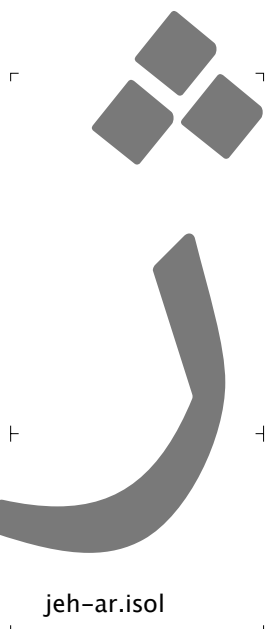

FB8A

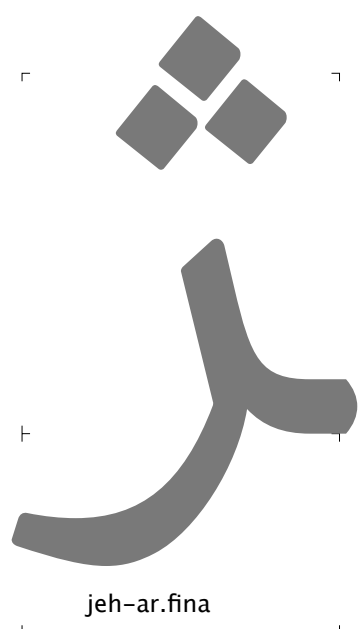

FB8B

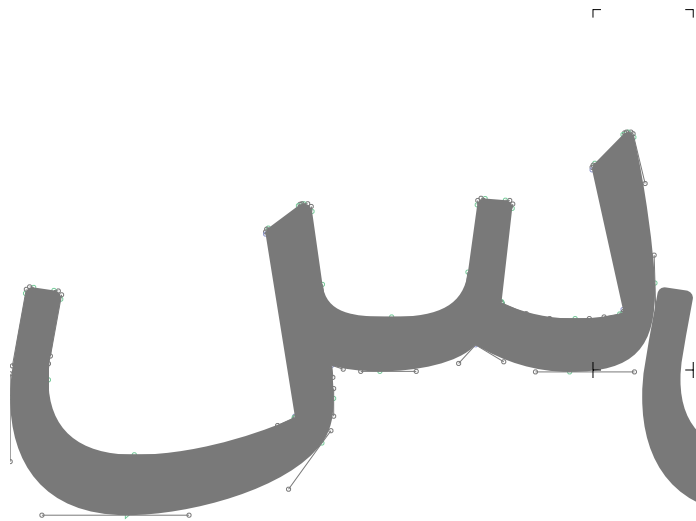

seen-ar

0633

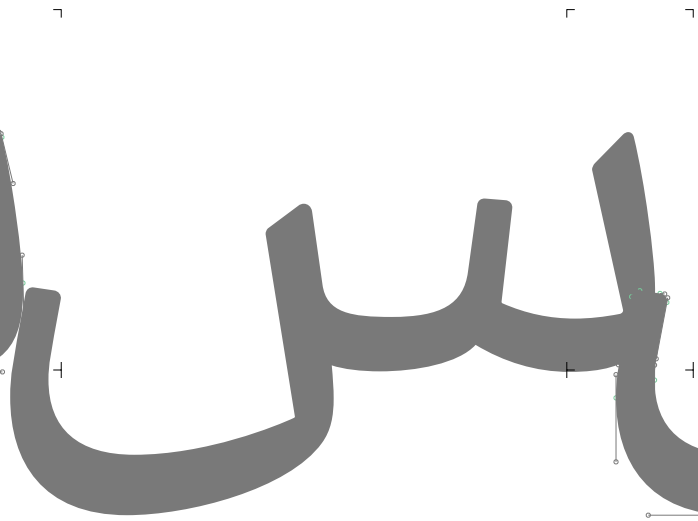

seen-ar.isol

FEB1



seen-ar.fina

FEB2

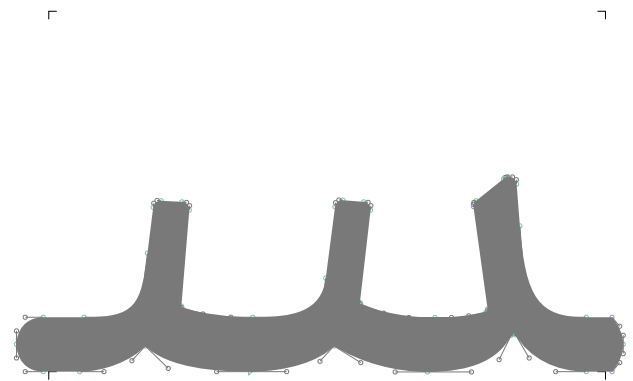

seen-ar.medi

FEB4

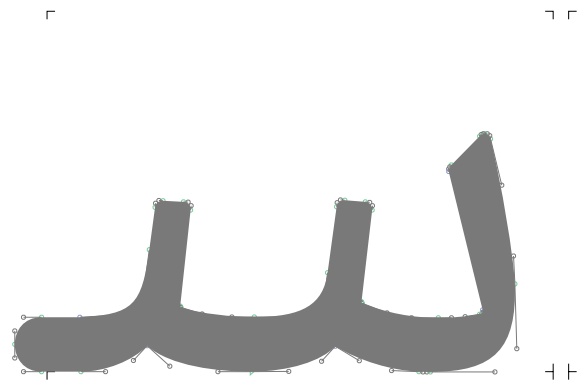

seen-ar.init

FEB3

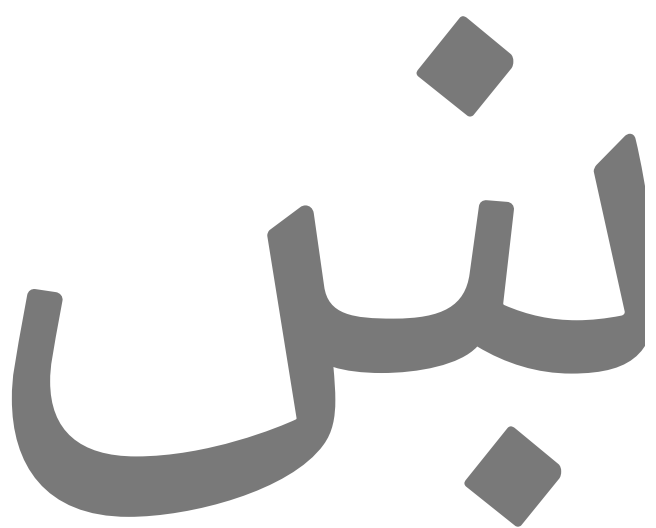

seenDotbelowDotabove-ar

069A

seenDotbelowDotabove-ar.fina

seenDotbelowDotabove-ar.init

seenDotbelowDotabove-ar.isol

seenDotbelowDotabove-ar.medi

sheen-ar

0634

sheen-ar.isol

FEB5

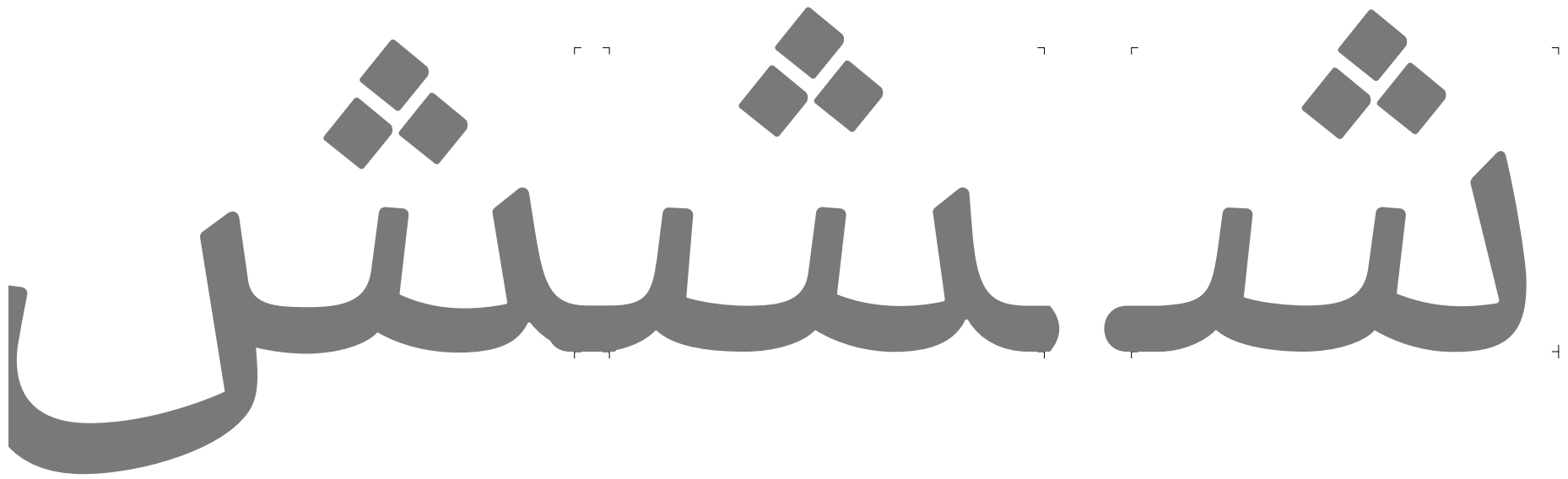

sheen-ar.fina

FEB6

sheen-ar.medi

FEB8

sheen-ar.init

FEB7



sad-ar

0635

sad-ar.isol

FEB9

sad-ar.fina

FEBA

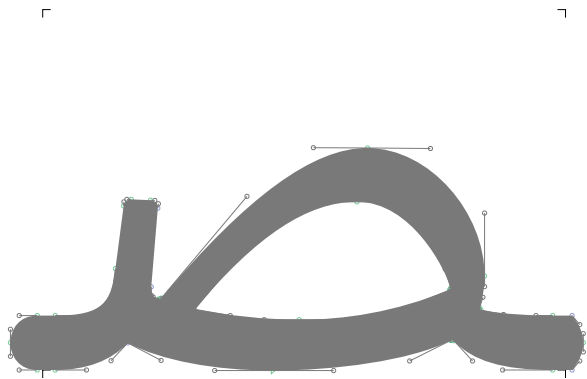

sad-ar.medi

FEBC



sad-ar.init

FEBB



dad-ar

0636

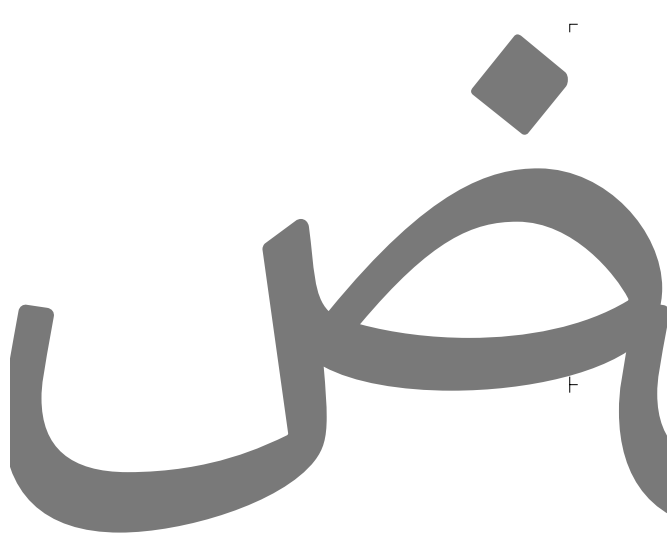

dad-ar.isol

FEBD

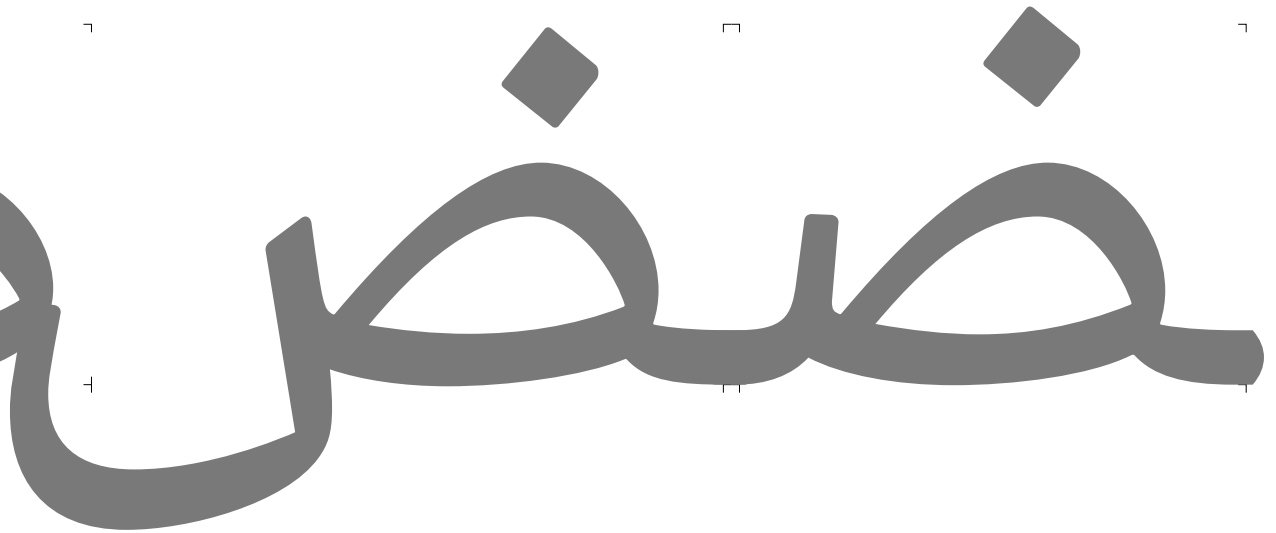

dad-ar.fina

FEBE

dad-ar.medi

FECO



dad-ar.init

FEBF

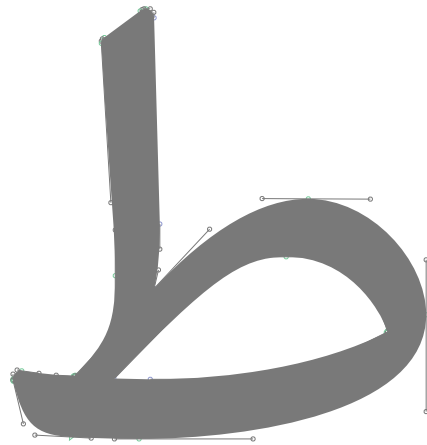

tah-ar

0637

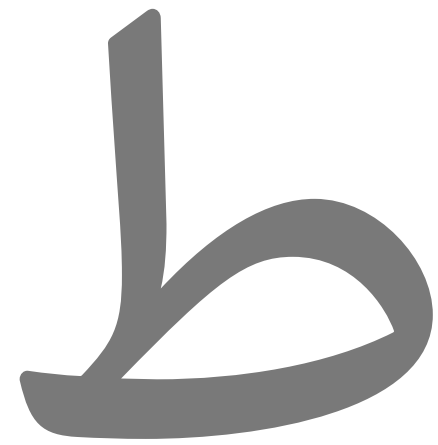

tah-ar.isol

FEC1



tah-ar.fina

FEC2

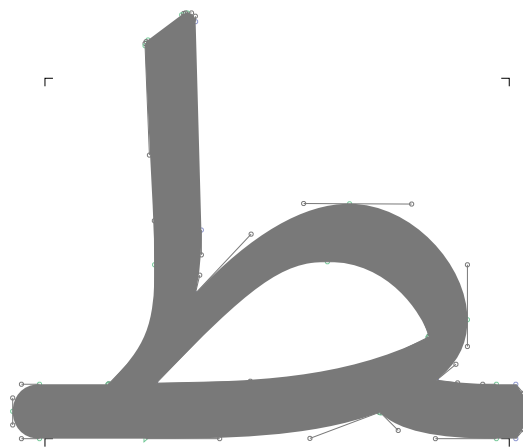

tah-ar.medi

FEC4

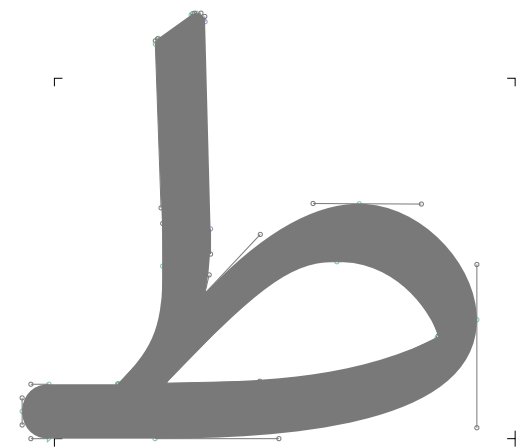

tah-ar.init

FEC3

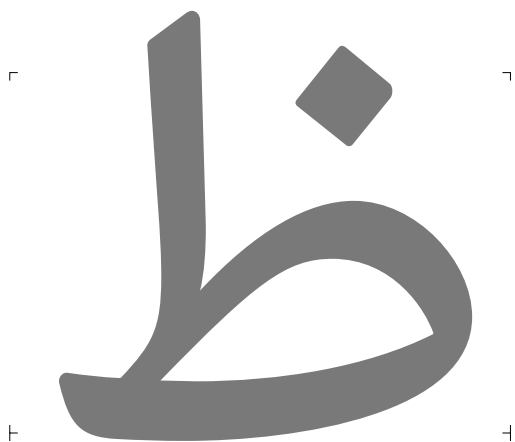

zah-ar

0638

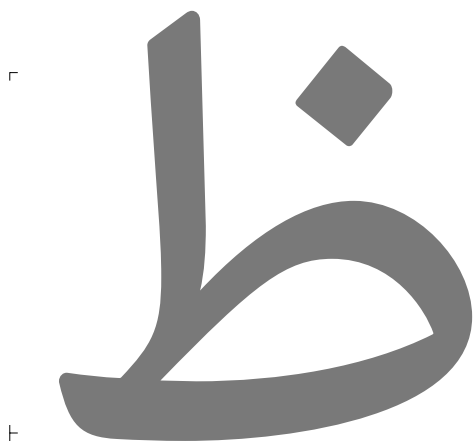

zah-ar.isol

FEC5



zah-ar.fina

FEC6



zah-ar.medi

FEC8

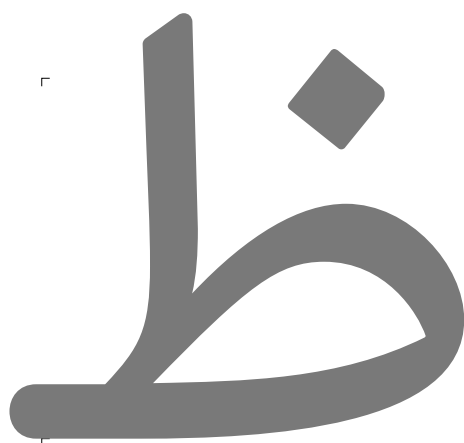

zah-ar.init

FEC7

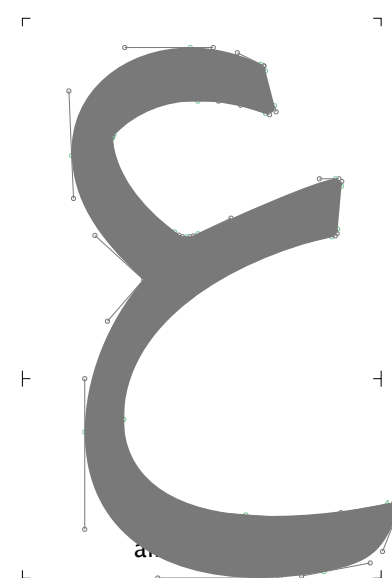

ar

0639

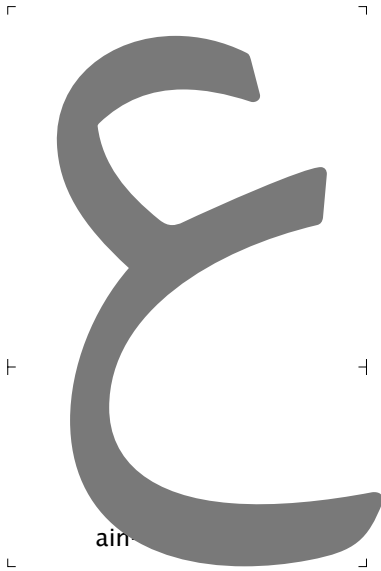

ain

FEC9

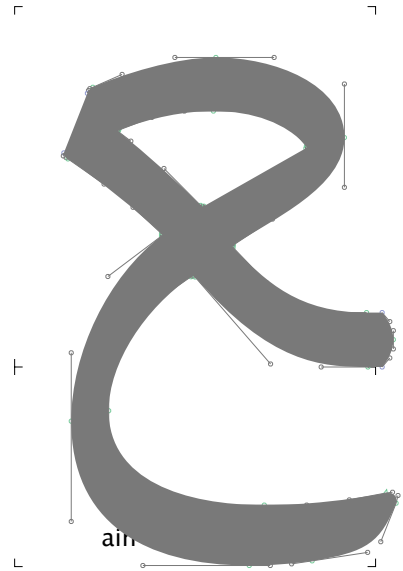

ain

FECA

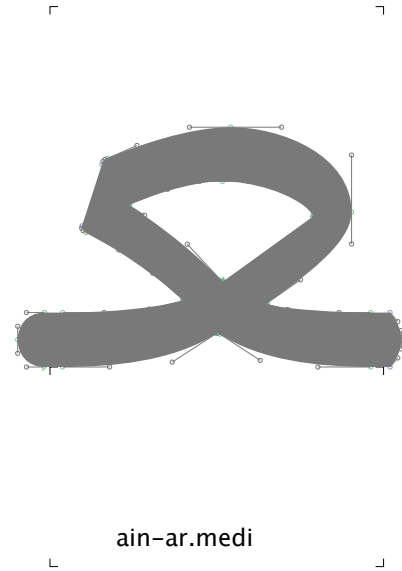

ain-ar.medi

FECC

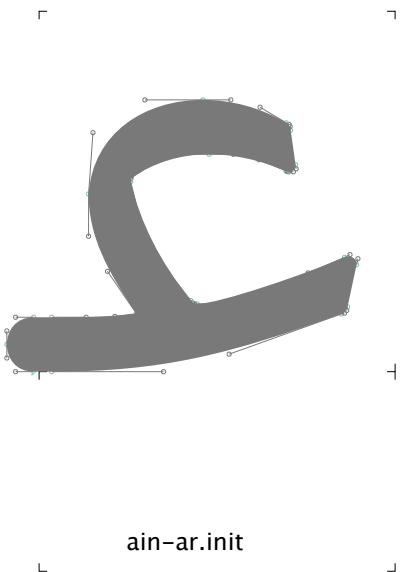

ain-ar.init

FECB

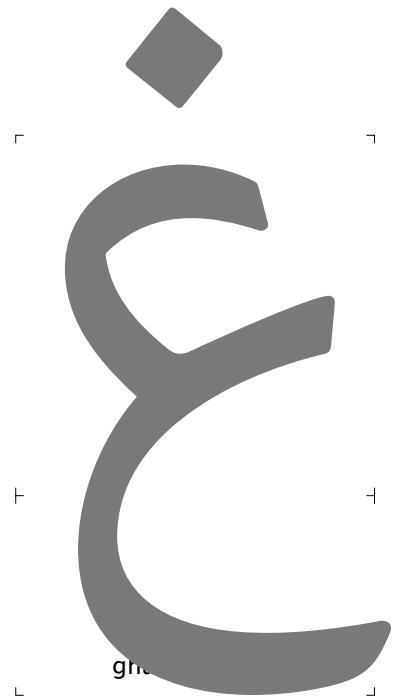

ghayn

063A

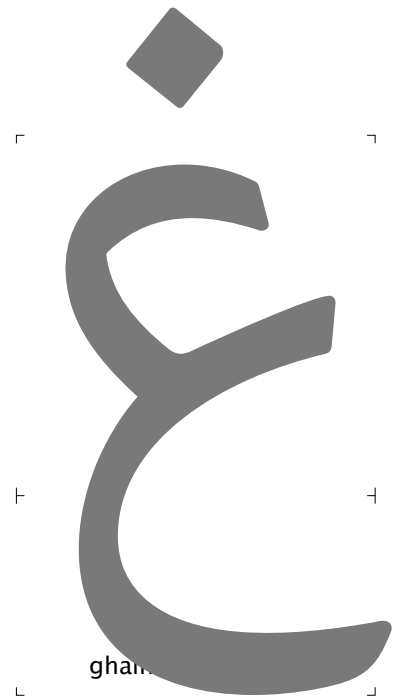

ghayn

FECD



ghayn

FECE

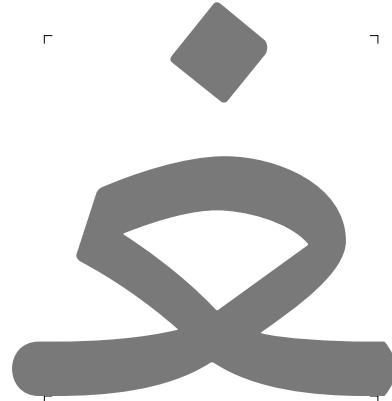

ghain-ar.medi

FED0

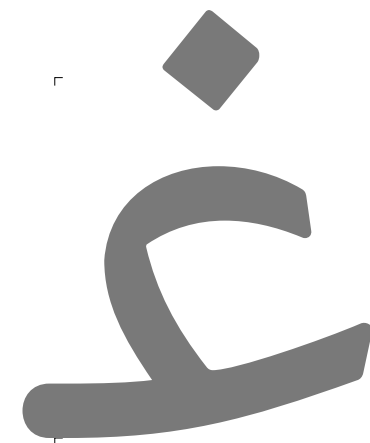

ghain-ar.init

FECF



feh-ar

0641



feh-ar.isol

FED1

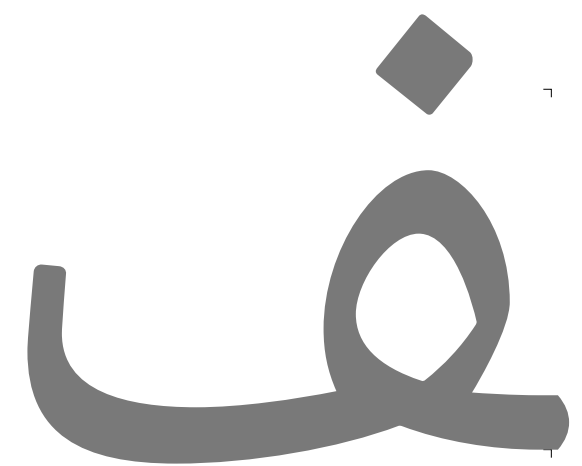

feh-ar.fina

FED2

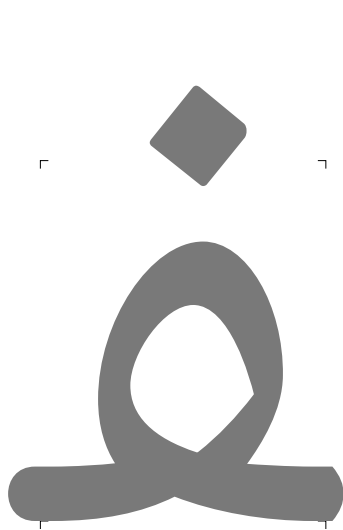

feh-ar.medi

FED4

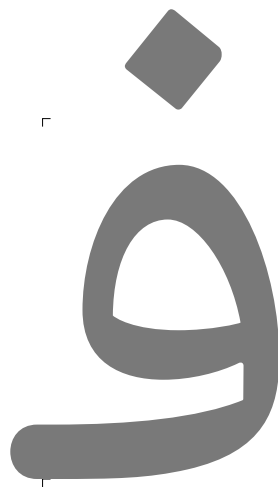

feh-ar.init

FED3



veh-ar

06A4



veh-ar.isol

FB6A

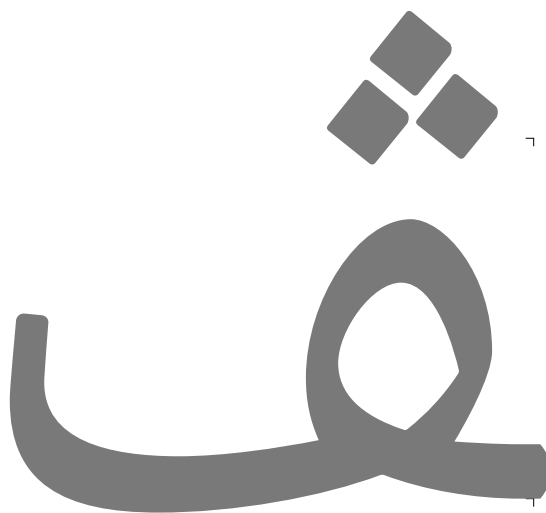

veh-ar.fina

FB6B

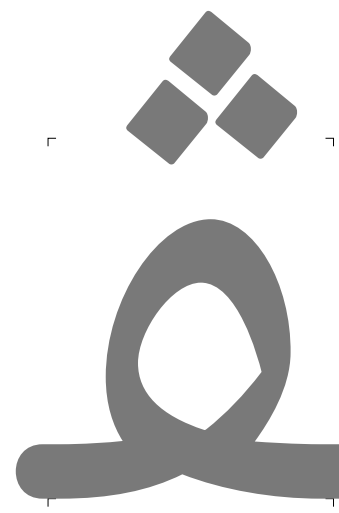

veh-ar.medi

FB6D

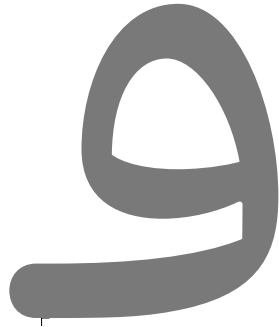

veh-ar.init

FB6C

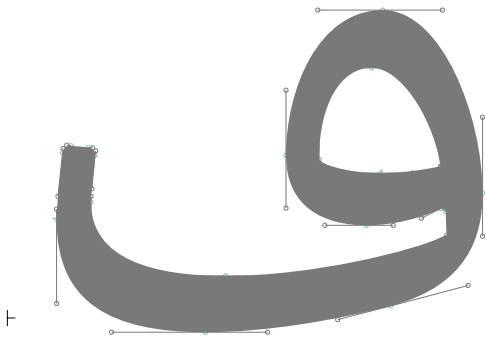

dotlessfeh-ar

06A1

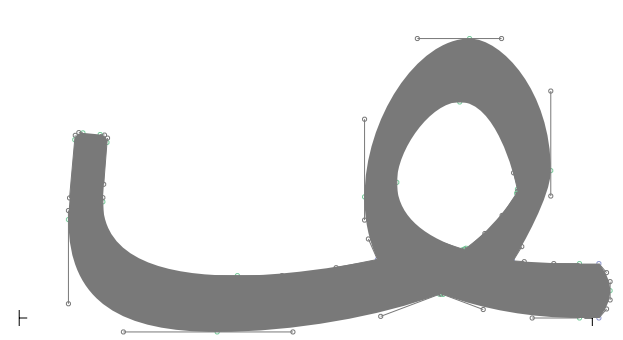

dotlessfeh-ar.fina

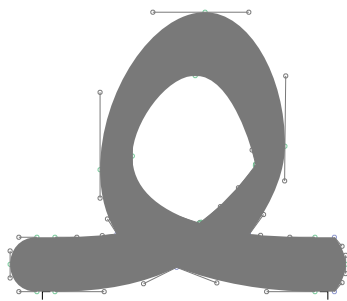

dotlessfeh-ar.medi

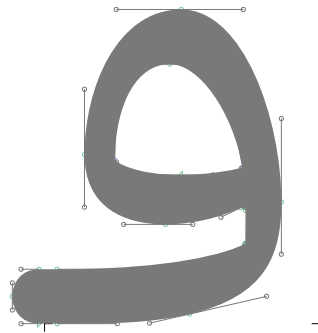

dotlessfeh-ar.init

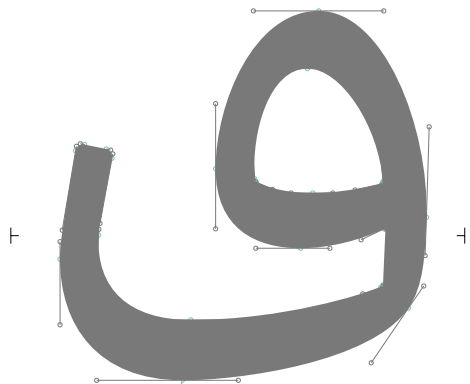

dotlessqaf-ar

066F

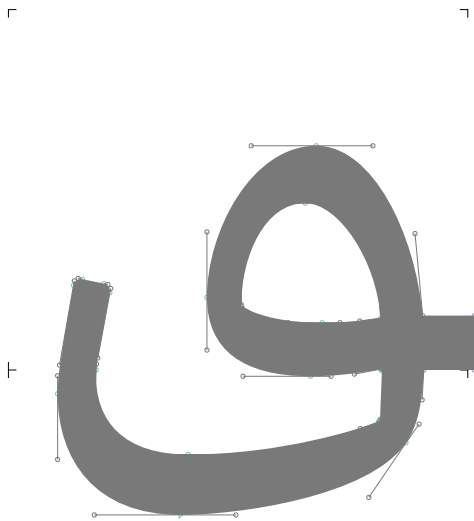

dotlessqaf-ar.fina



qaf-ar

0642



qaf-ar.isol

FED5



qaf-ar.fina

FED6

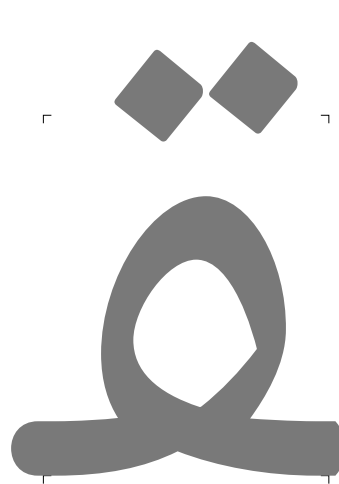

qaf-ar.medi

FED8

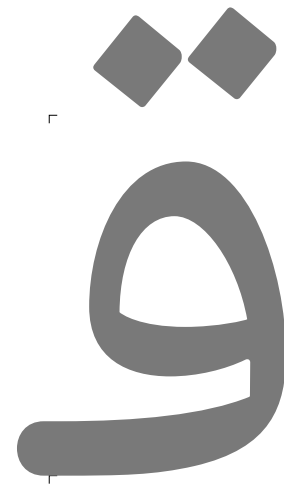

qaf-ar.init

FED7

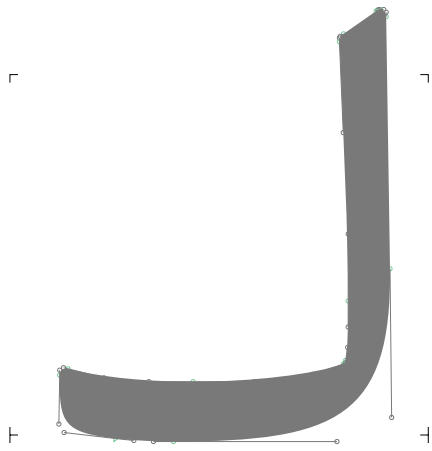

dotlesskaf-ar

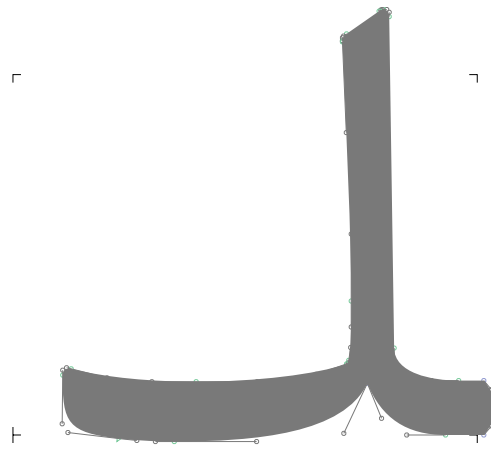

dotlesskaf-ar.fina

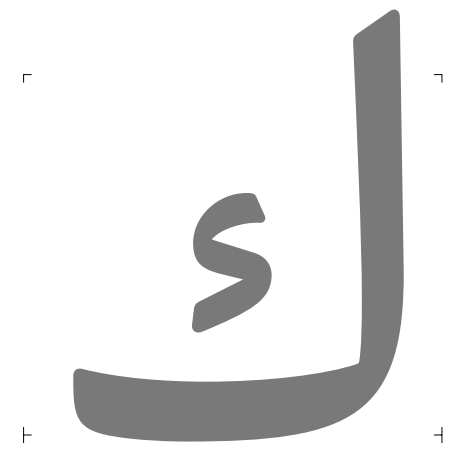

kaf-ar

0643

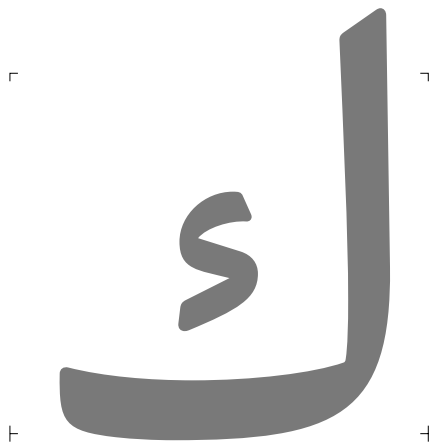

kaf-ar.isol

FED9

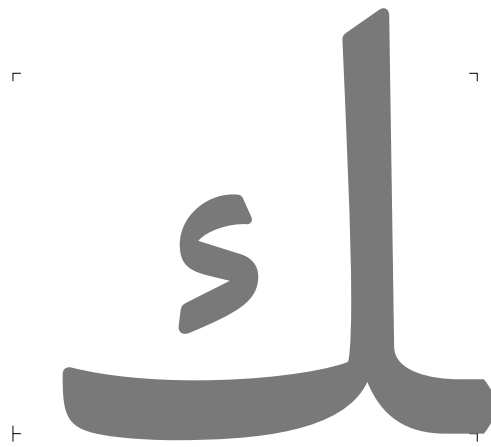

kaf-ar.fina

FEDA

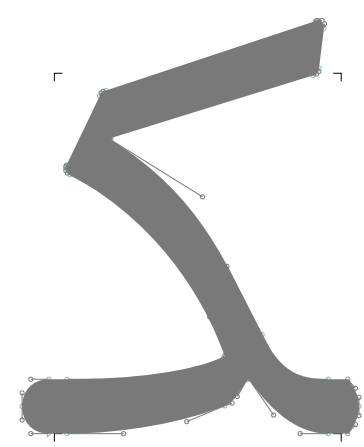

kaf-ar.medi

FEDC

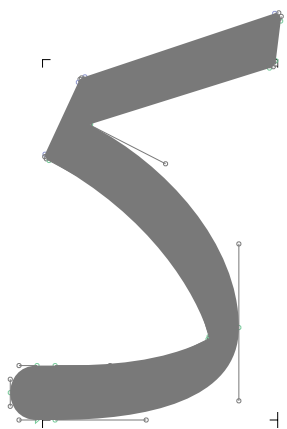

kaf-ar.init

FEDB

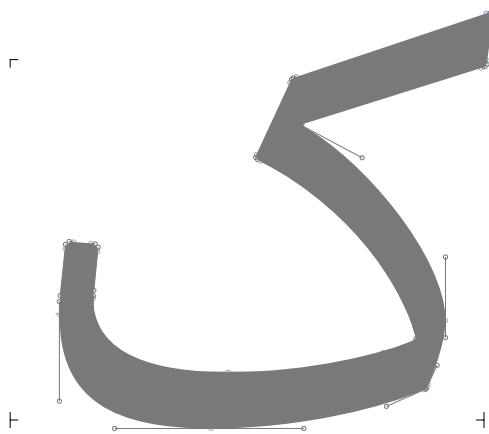

keheh-ar

06A9

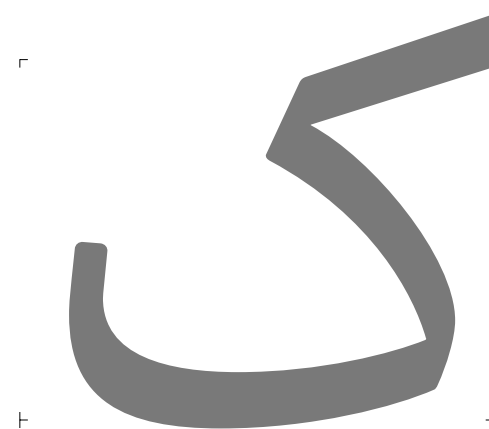

keheh-ar.isol

FB8E

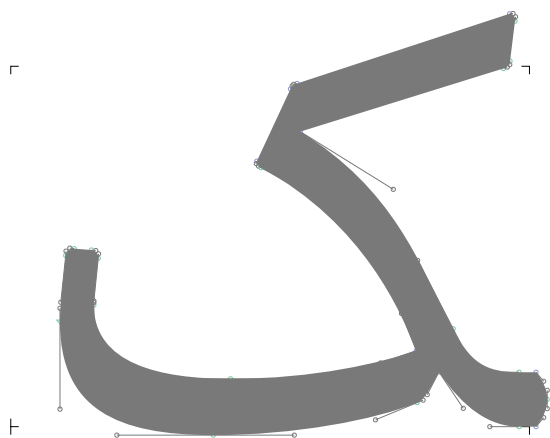

keheh-ar.fina

FB8F

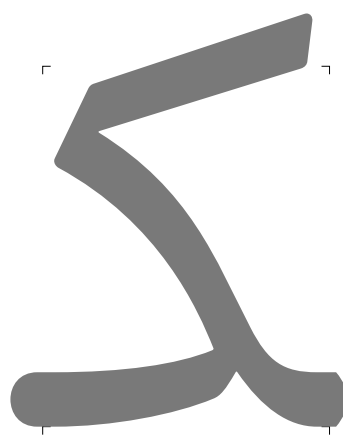

keheh-ar.medi

FB91

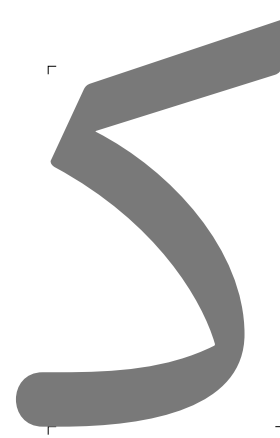

keheh-ar.init

FB90

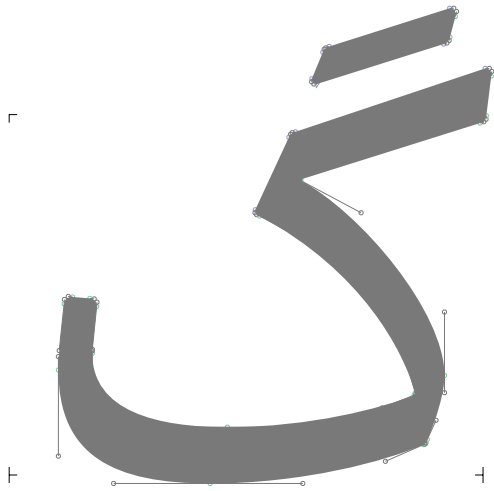

gaf-ar

06AF

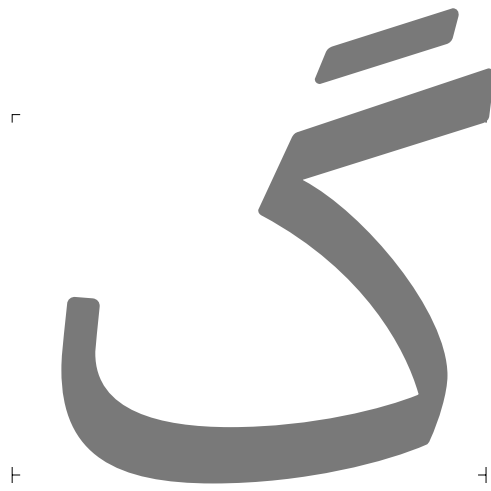

gaf-ar.isol

FB92

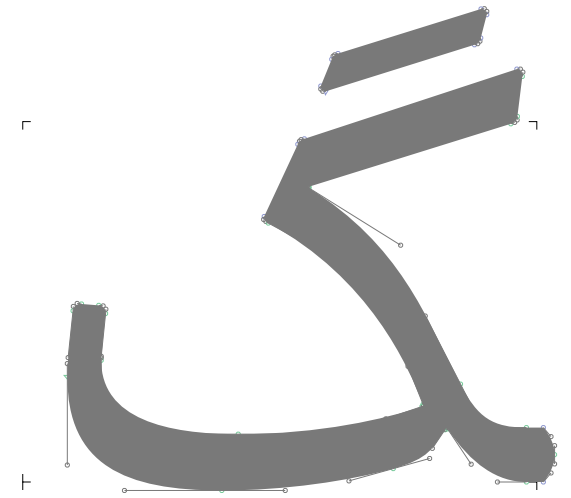

gaf-ar.fina

FB93

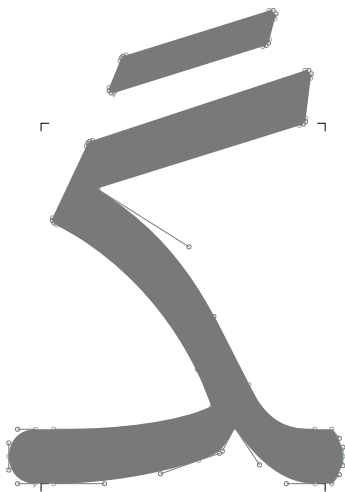

gaf-ar.medi

FB95

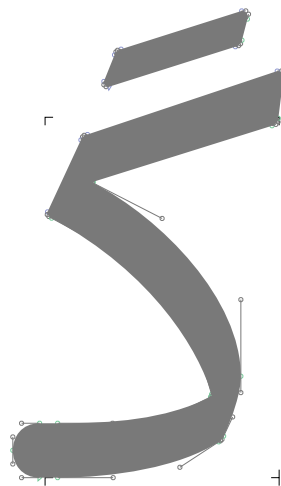

gaf-ar.init

FB94

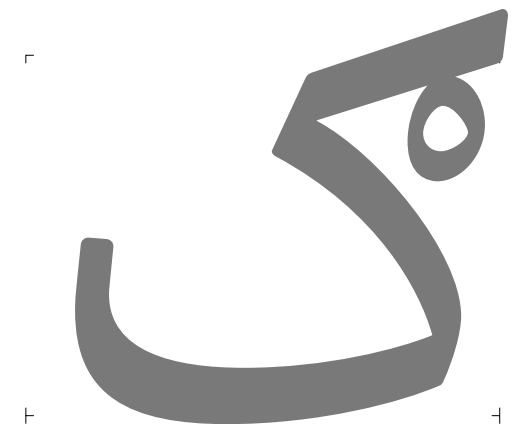

kafRing-ar

06AB



kafRing-ar.fina

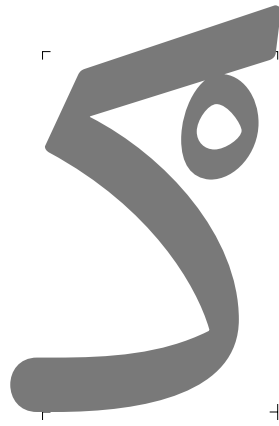

kafRing-ar.init

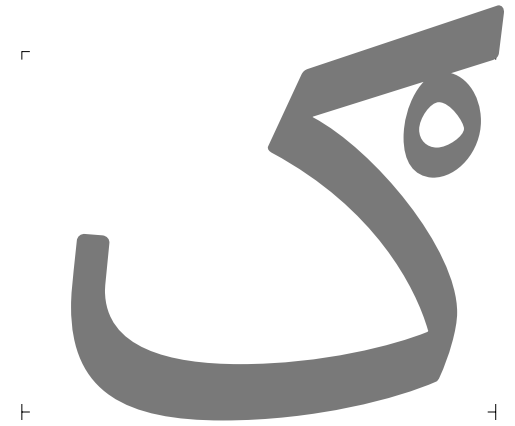

kafRing-ar.isol

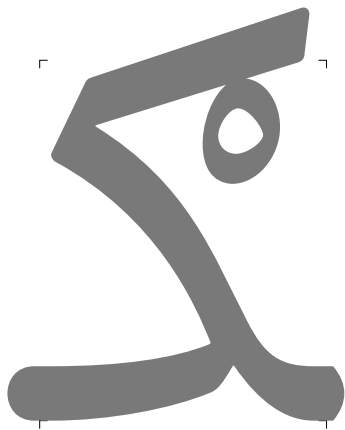

kafRing-ar.medi

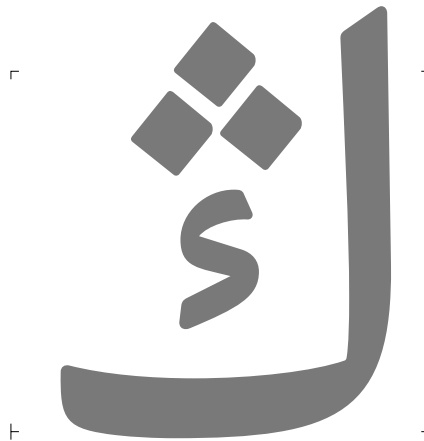

ng-ar

06AD

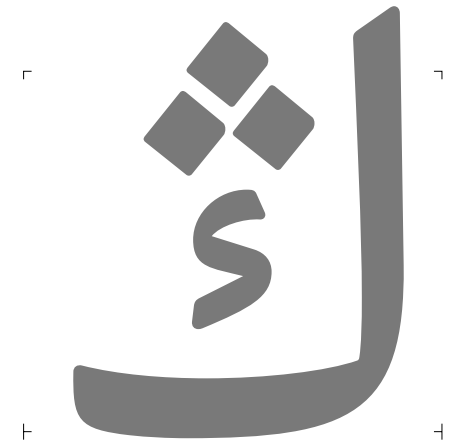

ng-ar.isol

FBD3

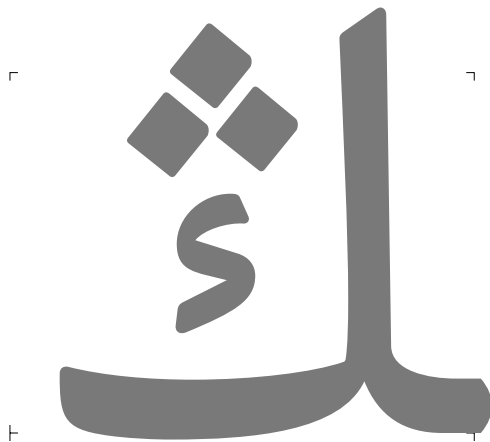

ng-ar.fina

FBD4

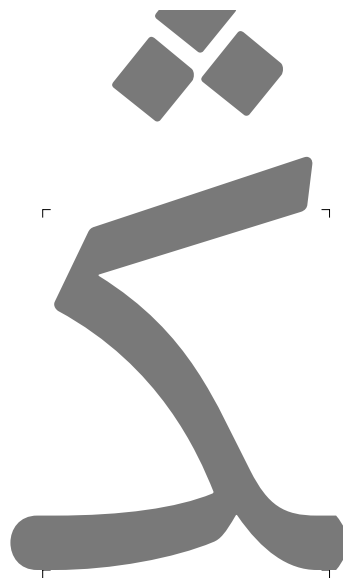

ng-ar.medi

FBD6

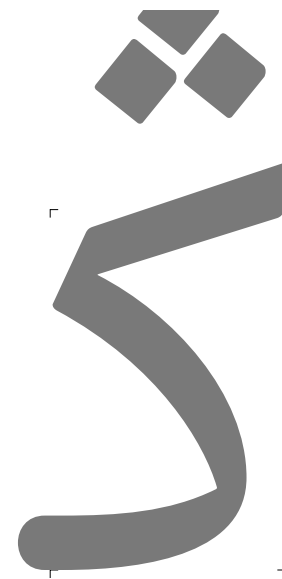

ng-ar.init

FBD5

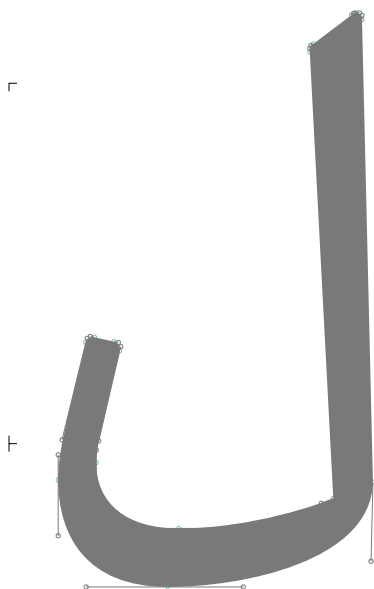

lam-ar

0644

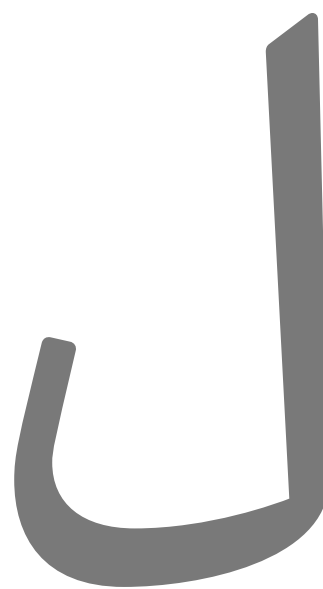

lam-ar.isol

FEDD

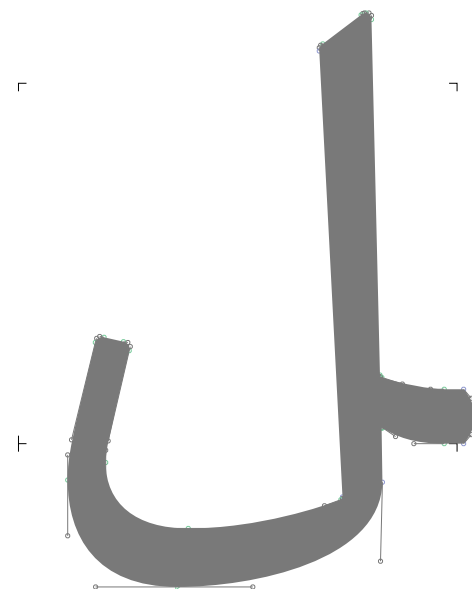

lam-ar.fina

FEDE

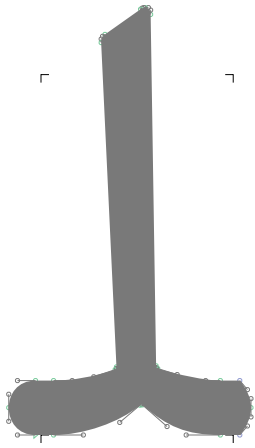

lam-ar.medi

FEE0

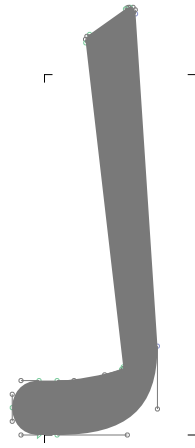

lam-ar.init

FEDF



lamVabove-ar

06B5

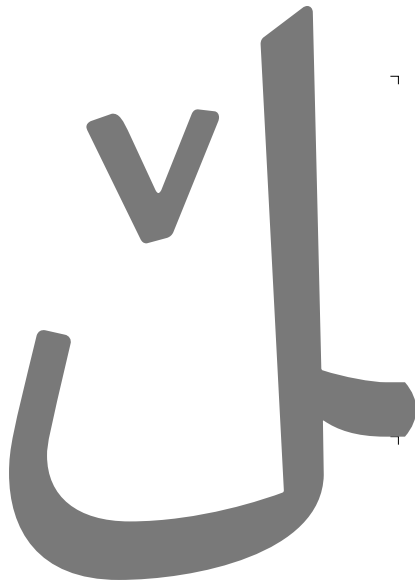

lamVabove-ar.fina

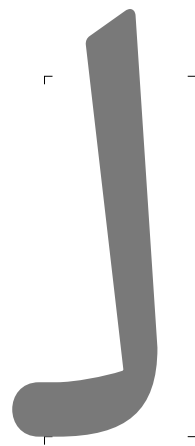

lamVabove-ar.init



lamVabove-ar.isol

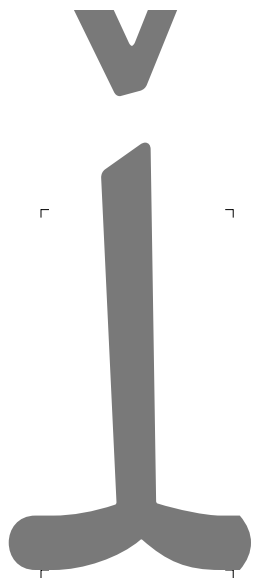

lamVabove-ar.medi

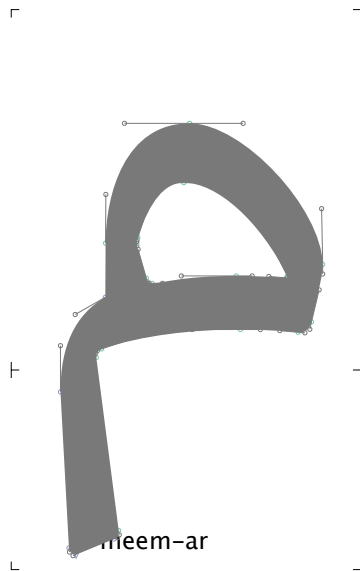

meem-ar

0645

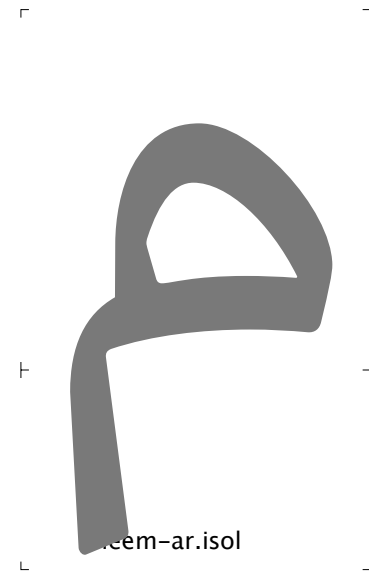

meem-ar.isol

FEE1

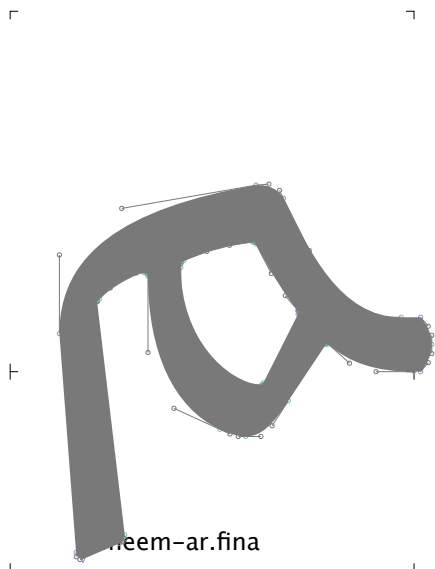

meem-ar.fina

FEE2

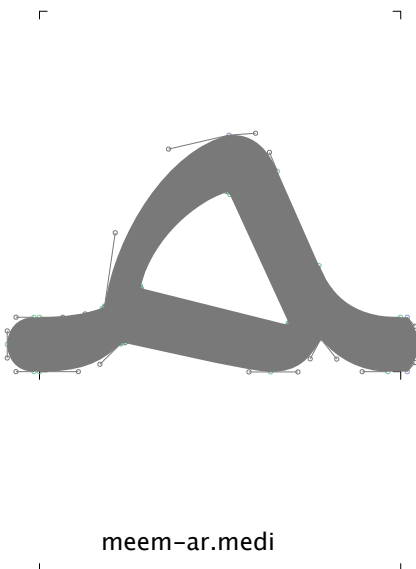

meem-ar.medi

FEE4

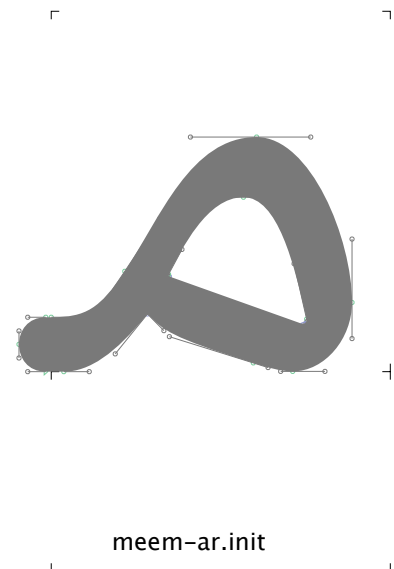

meem-ar.init

FEE3

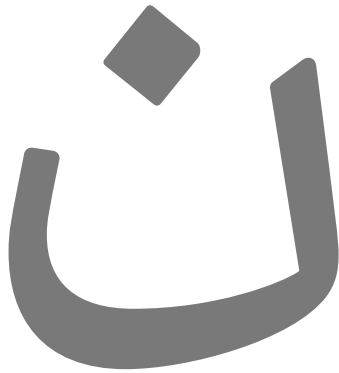

noon-ar

0646

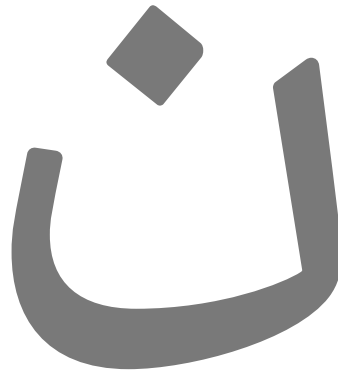

noon-ar.isol

FEE5

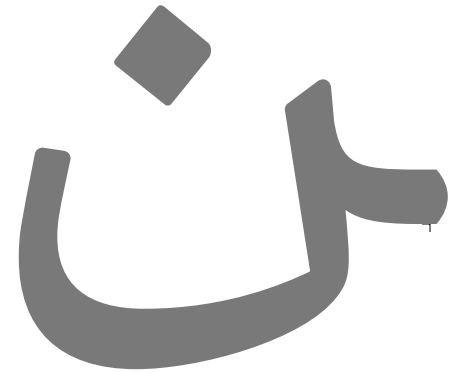

noon-ar.fina

FEE6

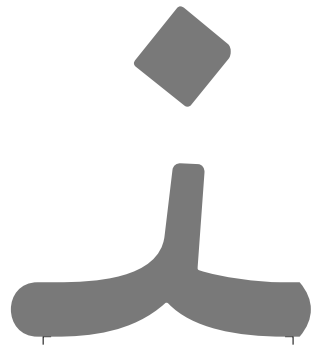

noon-ar.medi

FEE8



noon-ar.init

FEE7

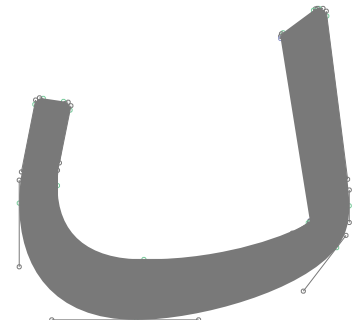

noonghunna-ar

06BA

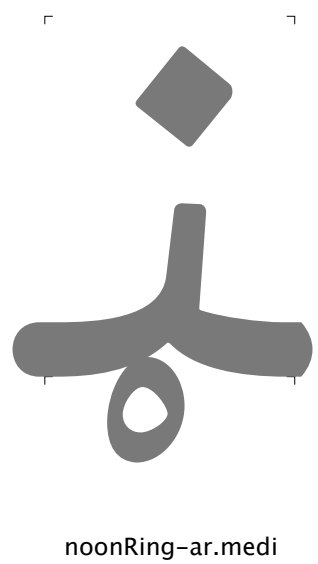
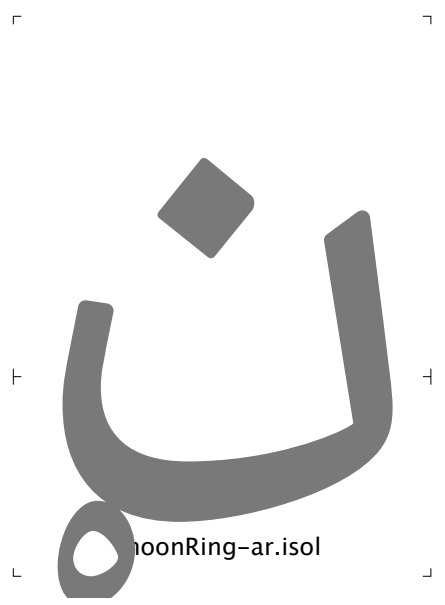
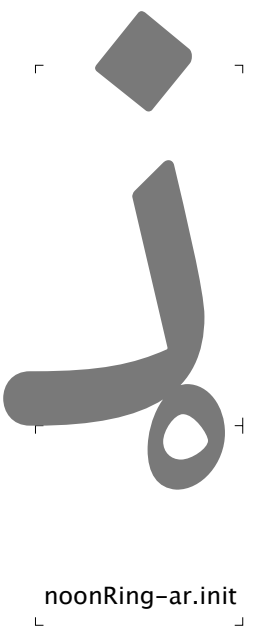
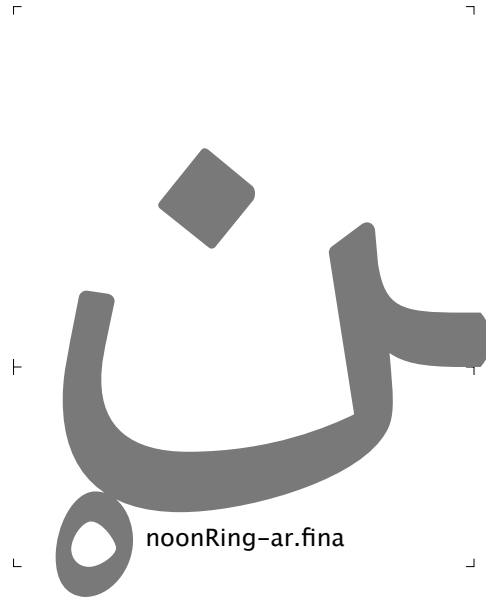
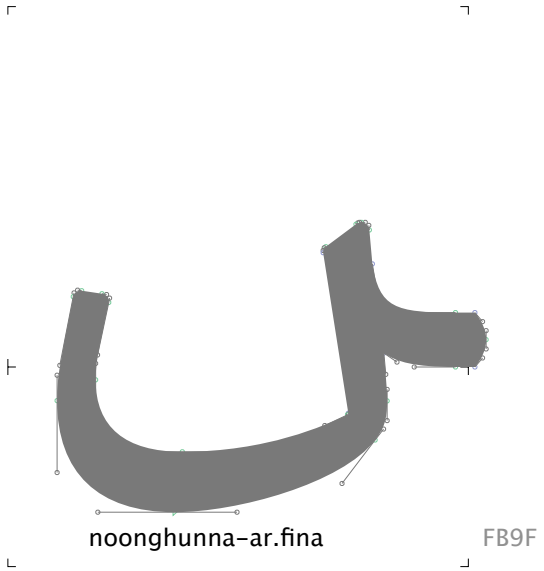

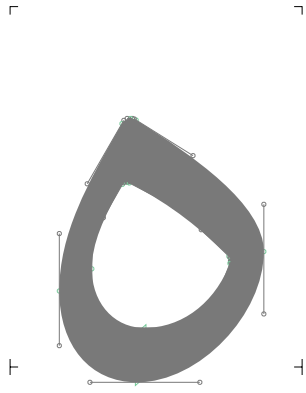

heh-ar

0647

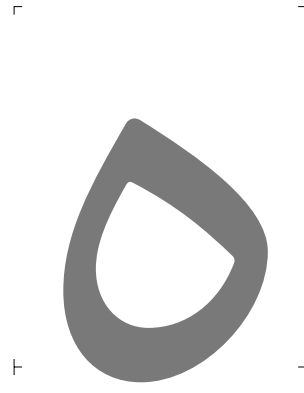

heh-ar.isol

FEE9

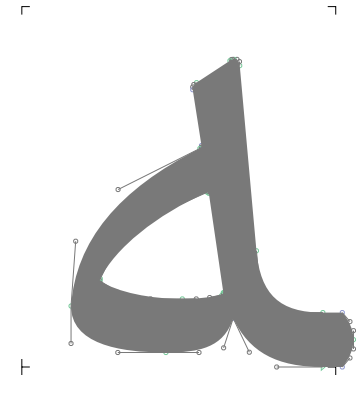

heh-ar.fina

FEFA

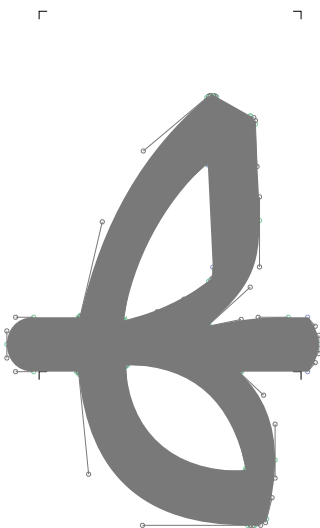

heh-ar.medi

FEFC

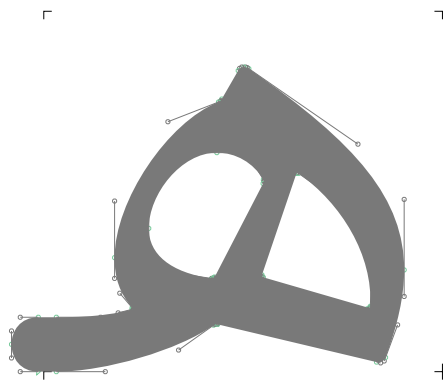

heh-ar.init

FEEB

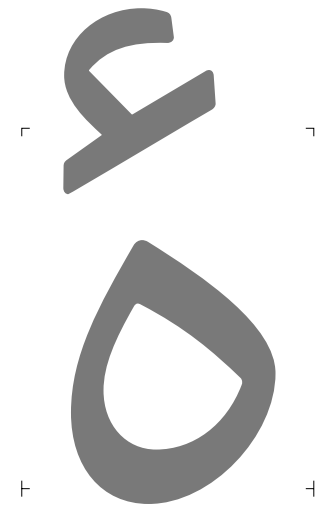

hehHamzaabove-ar

06C0

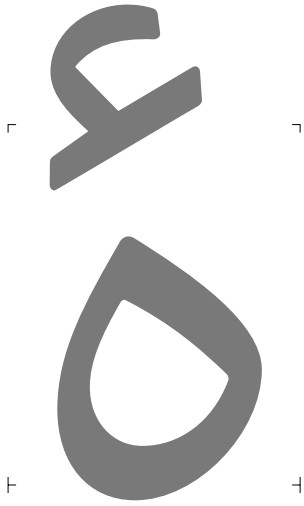

hehHamzaabove-ar.isol

FBA4

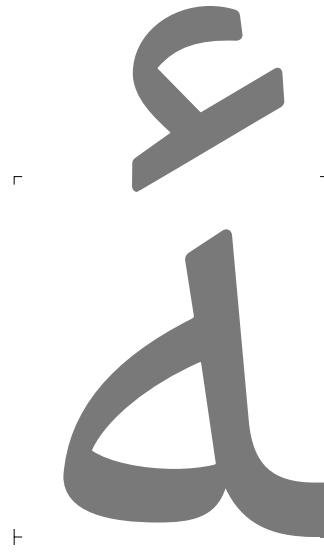

hehHamzaabove-ar.fina

FBA5

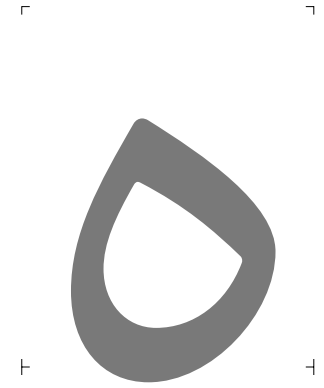

hehgoal-ar

06C1

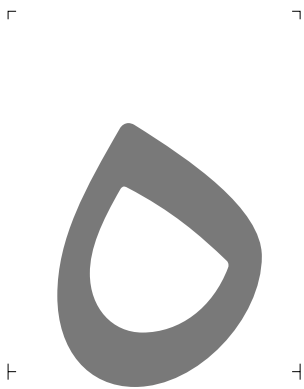

hehgoal-ar.isol

FBA6

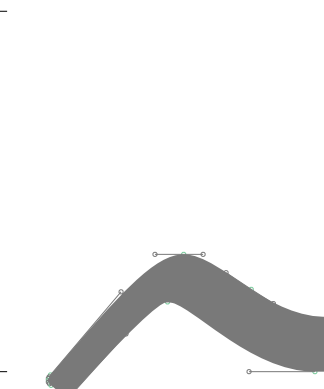

hehgoal-ar.fina

FBA7

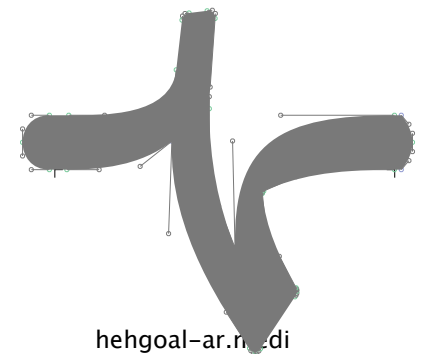

hehgoal-ar.medi

FBA9

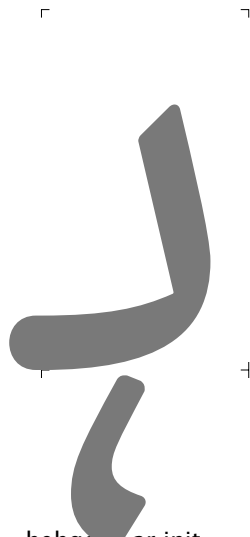

hehgoalHamzaabove-ar.init

FBA8

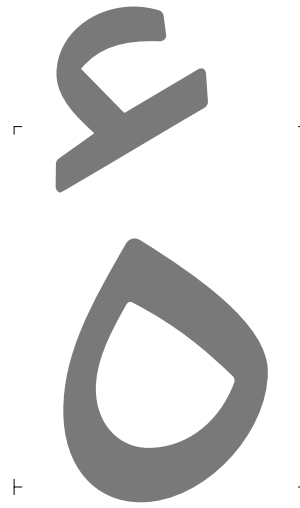

hehgoalHamzaabove-ar

06C2

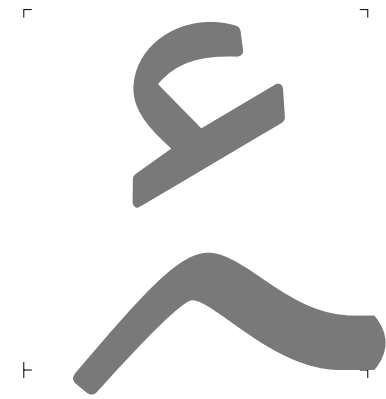

hehgoalHamzaabove-ar.fina

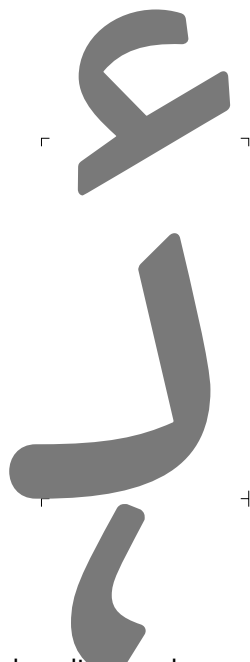

hehgoalHamzaabove-ar.init

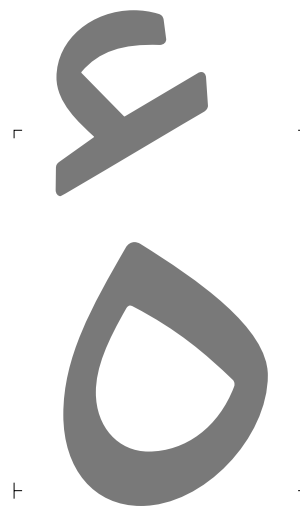

hehgoalHamzaabove-ar.isol



hehgoalHamzaabove-ar.medi

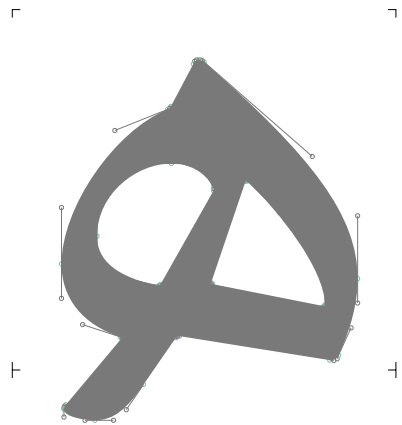

hehDoachashmee-ar

06BE

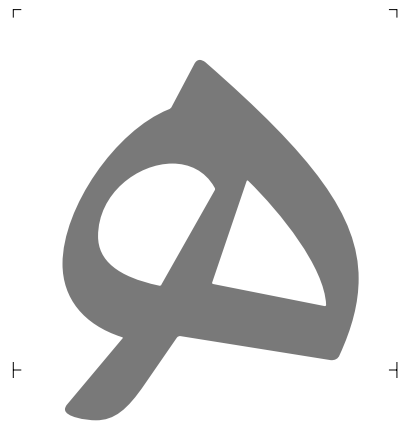

hehDoachashmee-ar.isol

FBAA

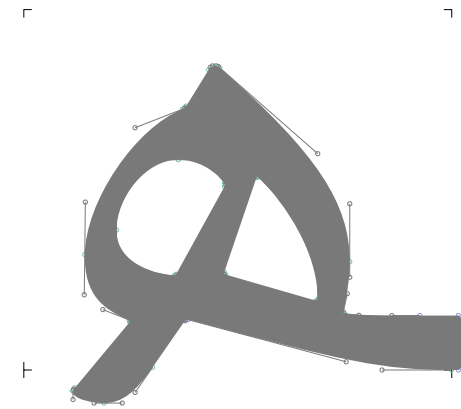

hehDoachashmee-ar.fina

FBAB

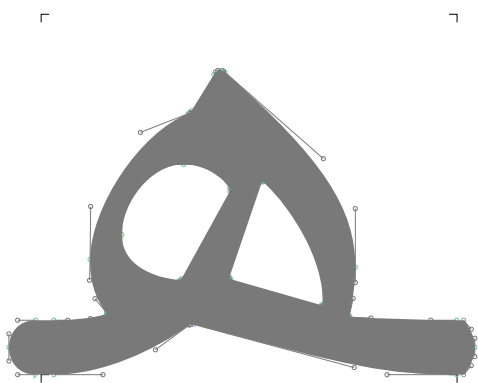

hehDoachashmee-ar.medi

FBAD

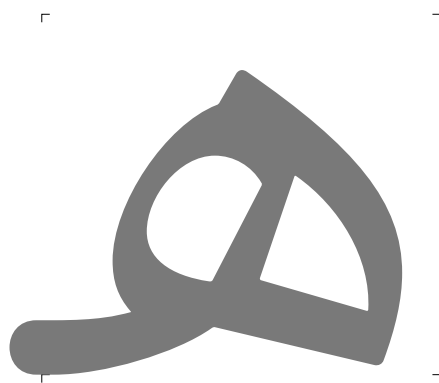

hehDoachashmee-ar.init

FBAC

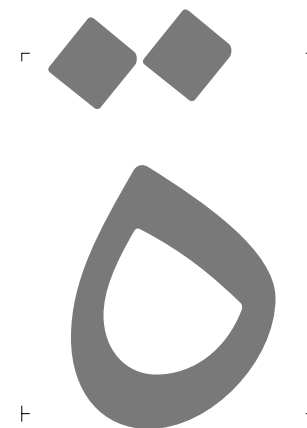

tehMarbuta-ar

0629

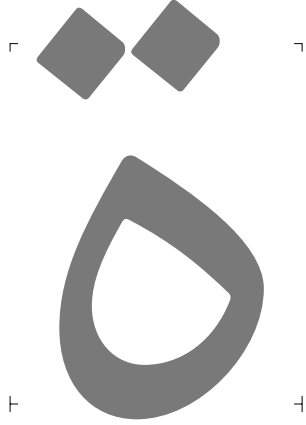

tehMarbuta-ar.isol

FE93

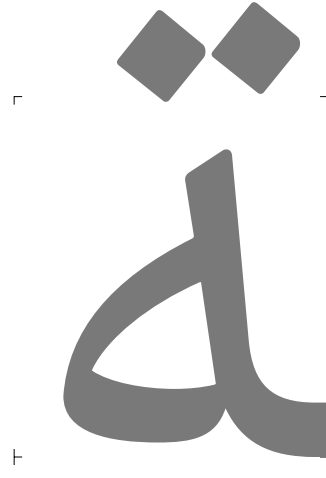

tehMarbuta-ar.fina

FE94

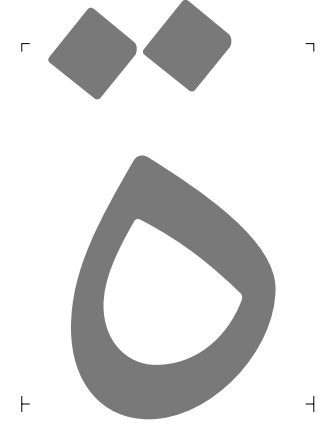

tehMarbutagoal-ar

06C3

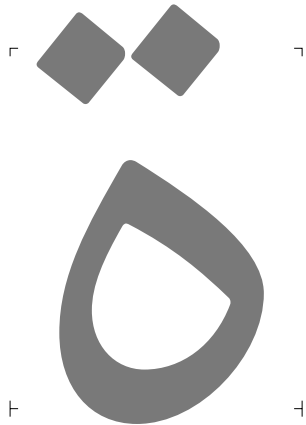

tehMarbutagoal-ar.isol

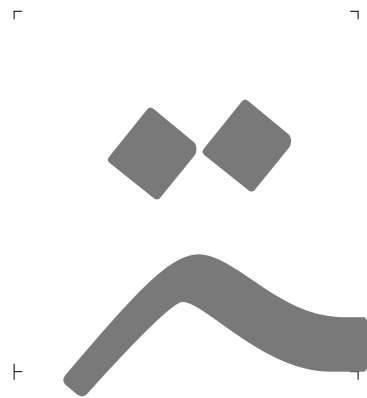

tehMarbutagoal-ar.fina

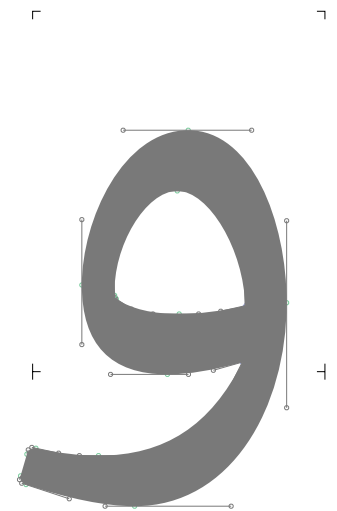

waw-ar

0648

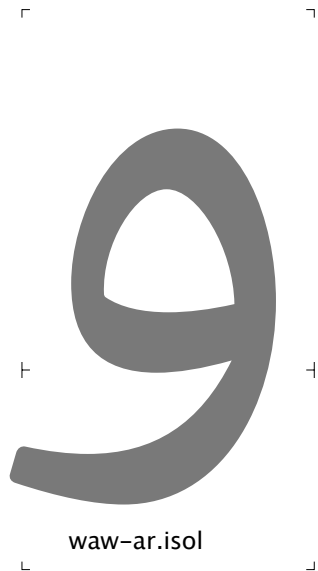

FEED

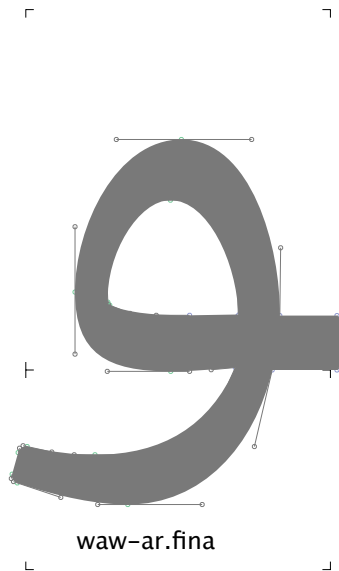

FEEE

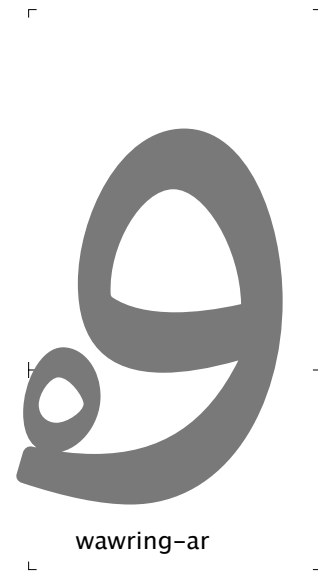

06C4

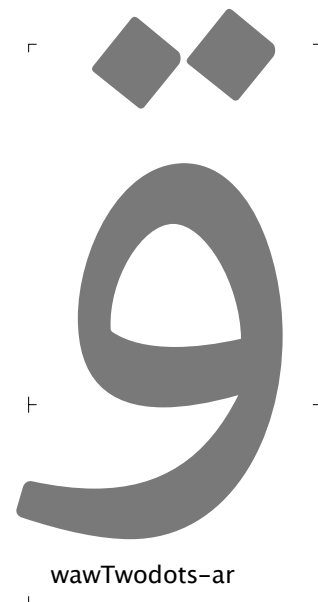
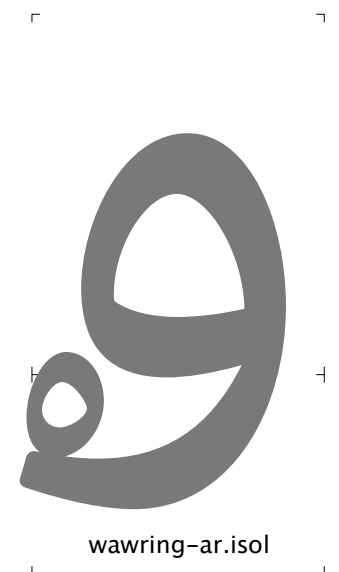
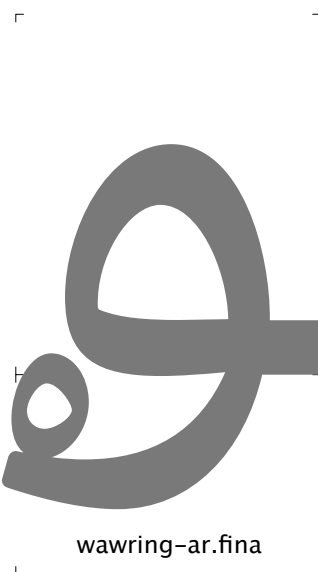

06CA

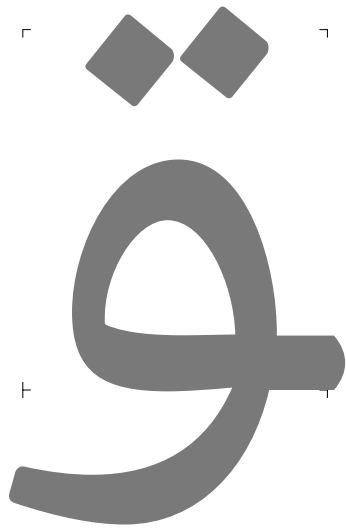

wawTwodots-ar.fina

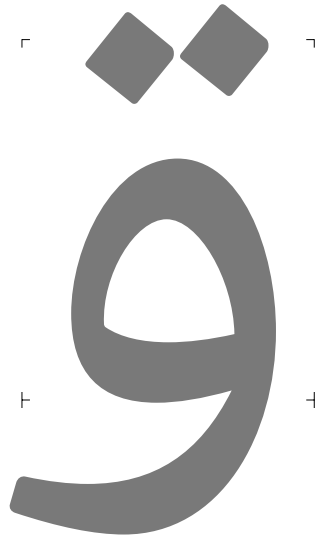

wawTwodots-ar.isol

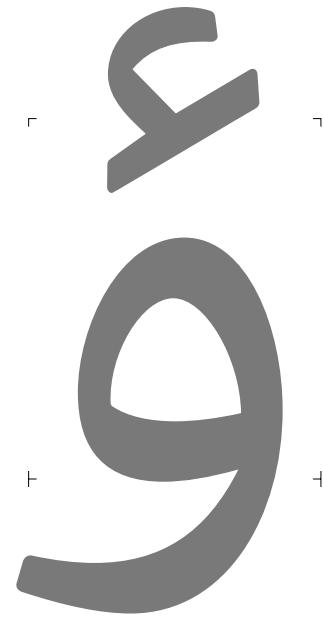

wawHamzaabove-ar

0624

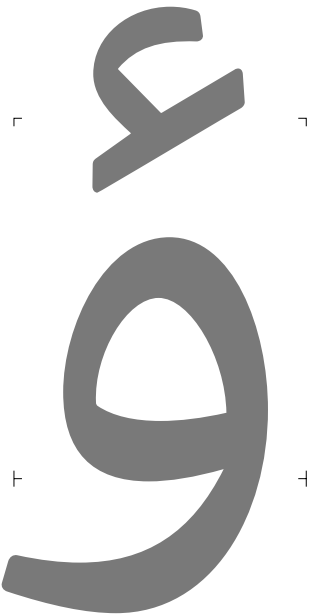

wawHamzaabove-ar.isol

FE85

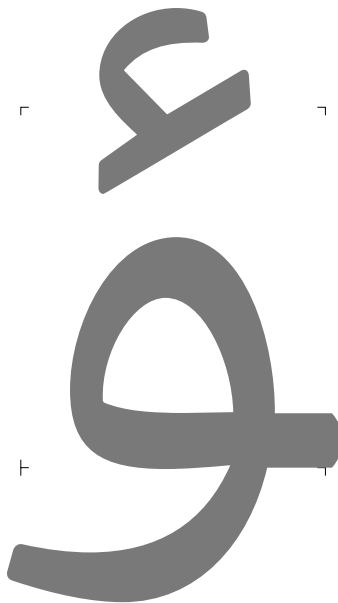

wawHamzaabove-ar.fina

FE86

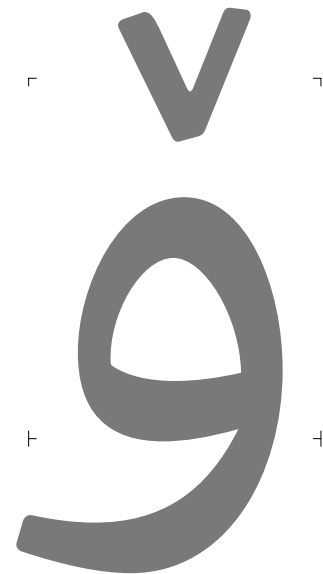

oe-ar

06C6

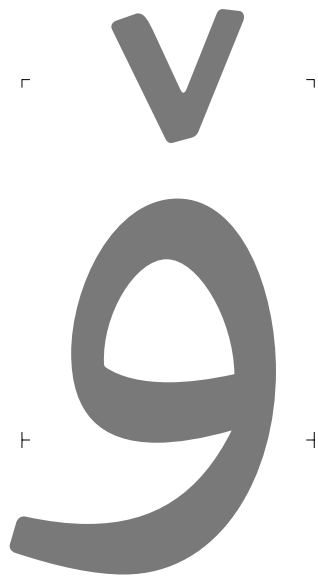

oe-ar.isol

FBD9

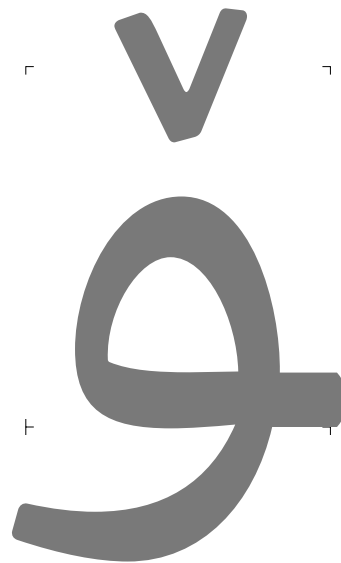

oe-ar.fina

FBD A

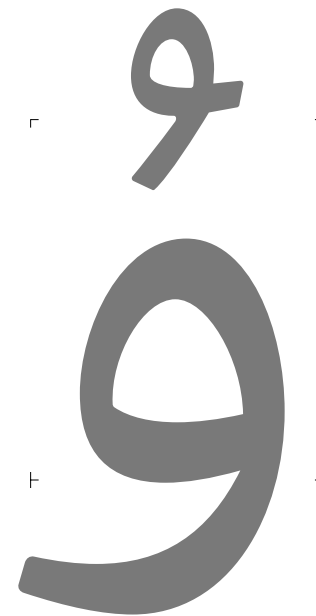

u-ar

06C7

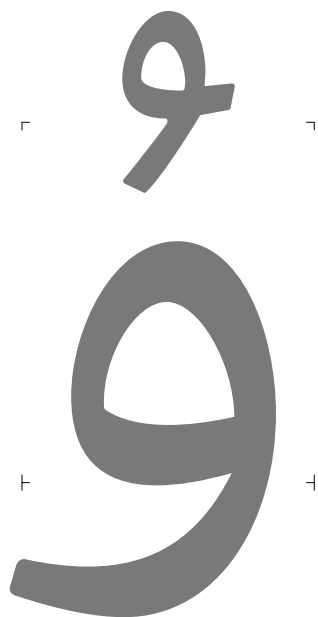

u-ar.isol

FBD7

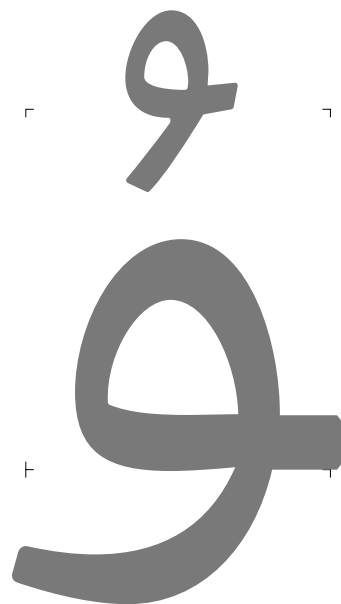

u-ar.fina

FBD8

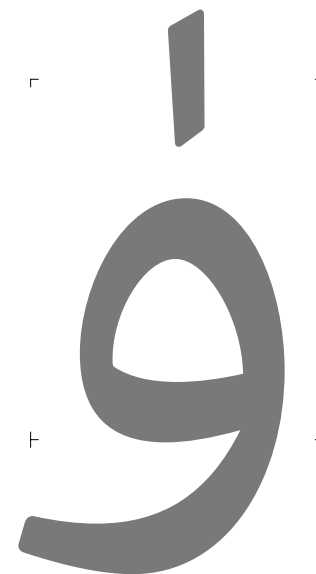

yu-ar

06C8

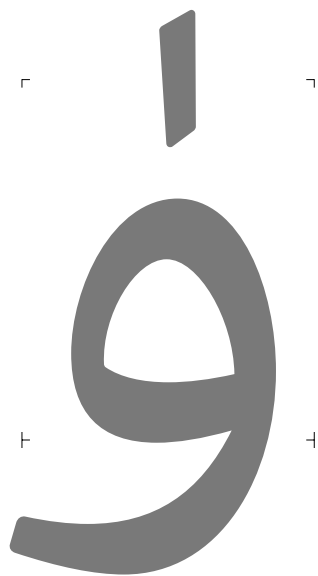

yu-ar.isol

FBDB

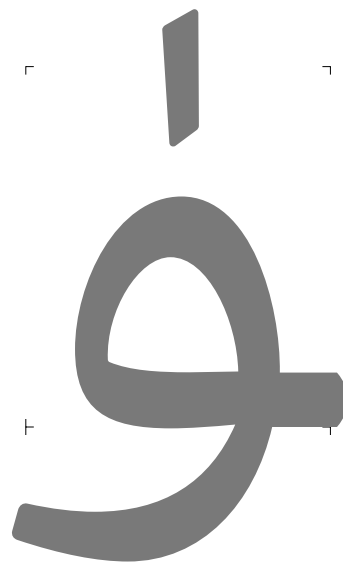

yu-ar.fina

FBDC

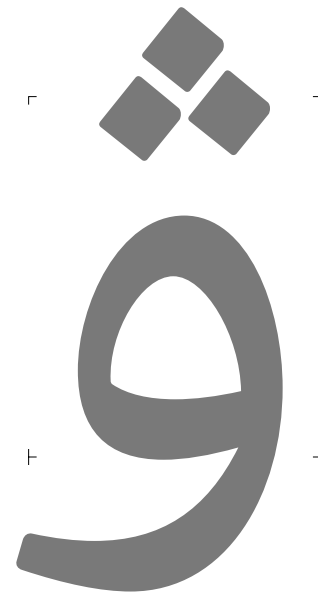

ve-ar

06CB

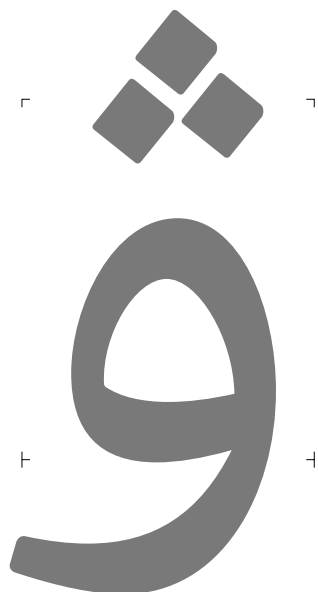

ve-ar.isol

FBDE

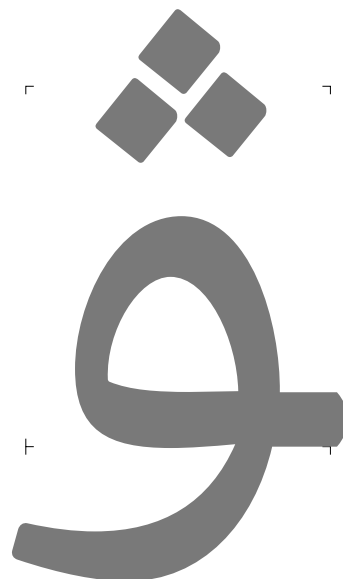

ve-ar.fina

FBDF

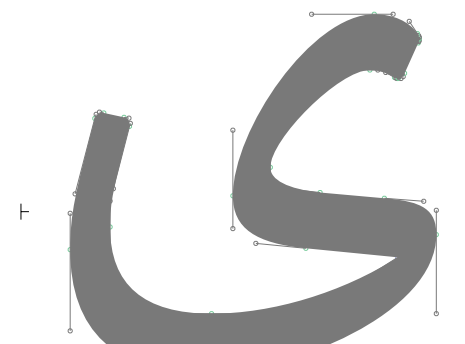

alefMaksura-ar

0649



alefMaksura-ar.isol

FEEF

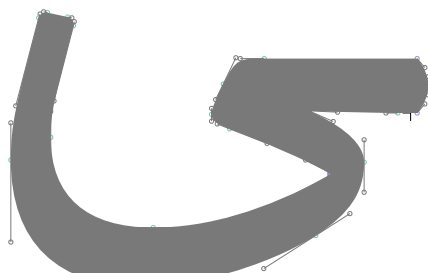

alefMaksura-ar.fina

FEF0



yeh-ar

064A



yeh-ar.isol

FEF1



yeh-ar.fina

FEF2

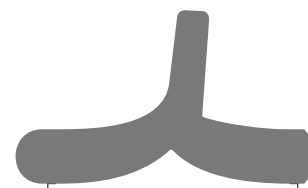

yeh-ar.medi

FEF4



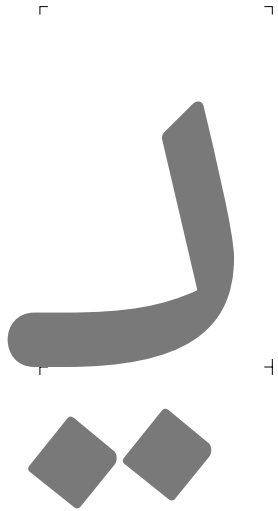

yeh-ar.init

FEF3

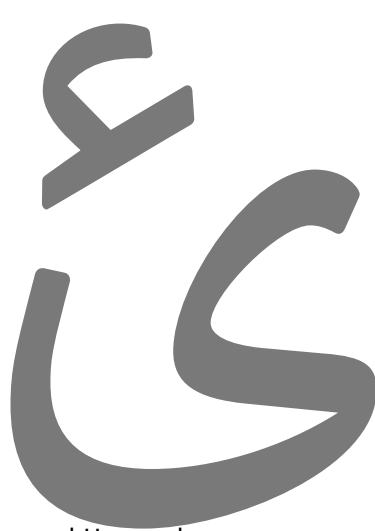

yehHamzaabove-ar

0626

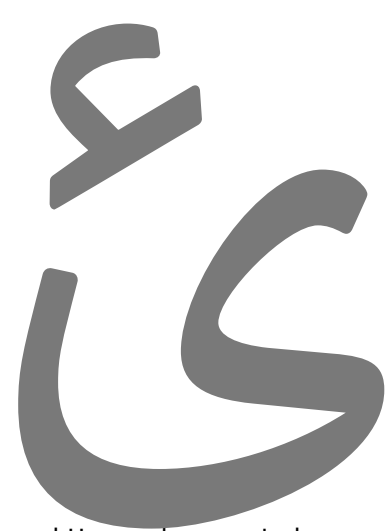

yehHamzaabove-ar.isol

FE89

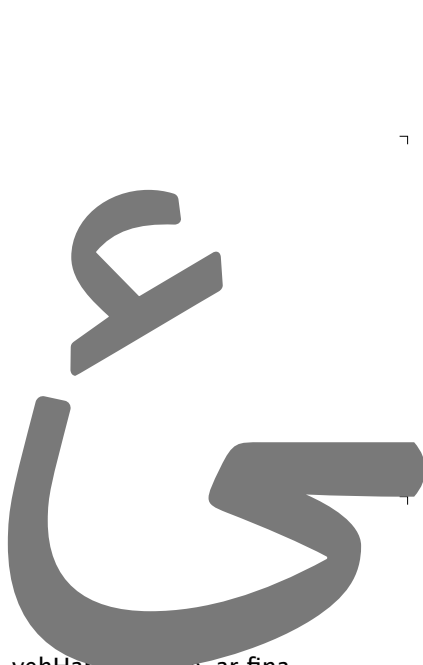

yehHamzaabove-ar.fina

FE8A

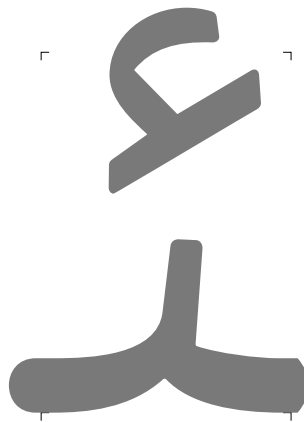

yehHamzaabove-ar.medi

FE8C

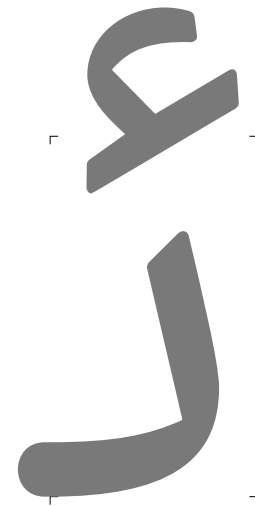

yehHamzaabove-ar.init

FE8B



yehVabove-ar

06CE



yehVabove-ar.fina

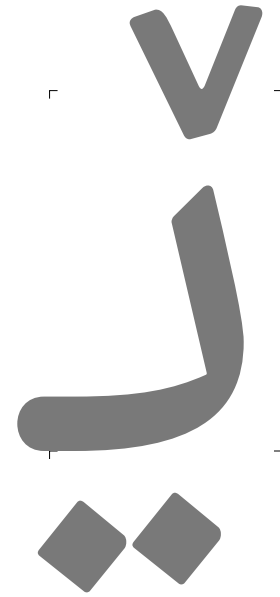

yehVabove-ar.init



yehVabove-ar.isol

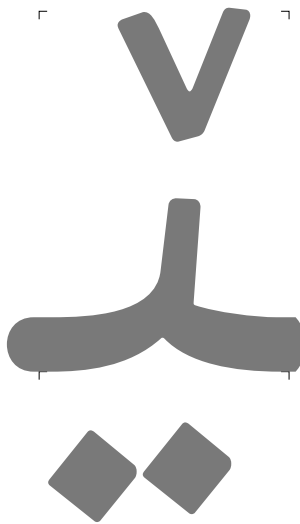

yehVabove-ar.medi



yeh-farsi

06CC



yeh-farsi.isol

FBFC



yeh-farsi.tlta

FBFD

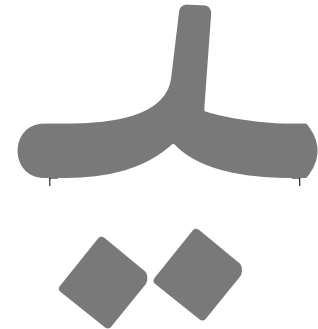

yeh-farsi.medi

FBFF

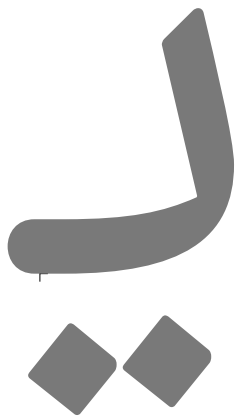

yeh-farsi.init

FBFE

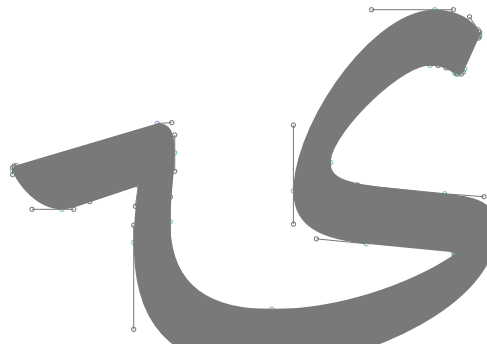

yehTail-ar

06CD

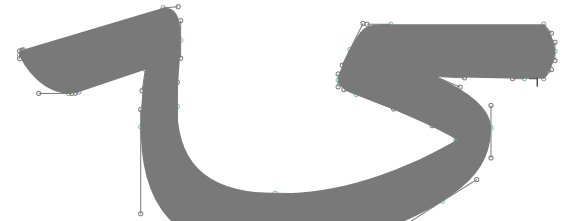

yehTail-ar.tlta

yehTail-ar.isol

e-ar

06D0

e-ar.isol

FBE4



e-ar.mda

FBE5

e-ar.mdi

FBE7

e-ar.mrit

FBE6

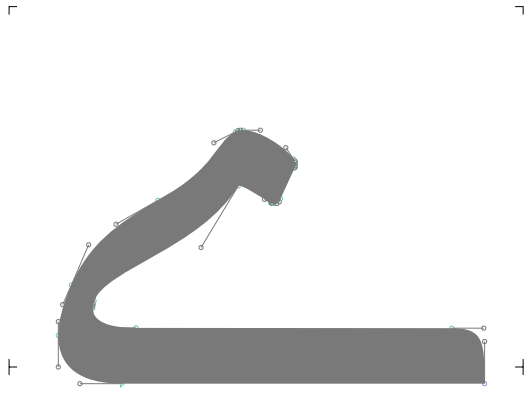

yehbarree-ar

06D2



yehbarree-ar.isol

FBAE



yehbarree-ar.fina

FBAF

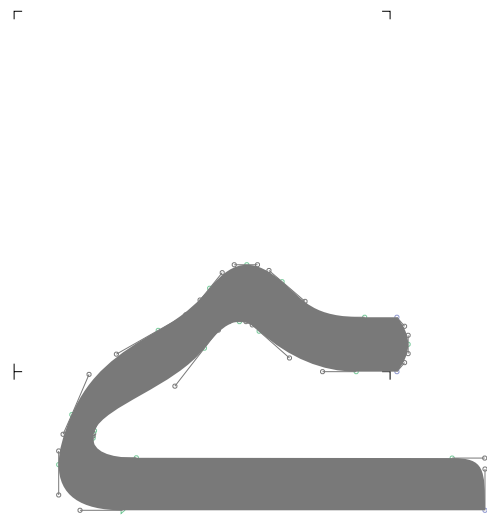

yehbarree-ar.fina.001

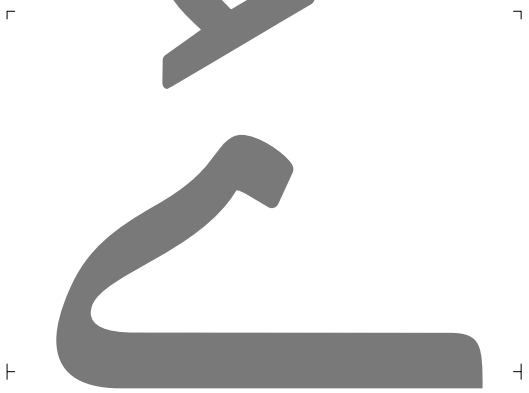

yehbarreeHamzaabove-ar

06D3

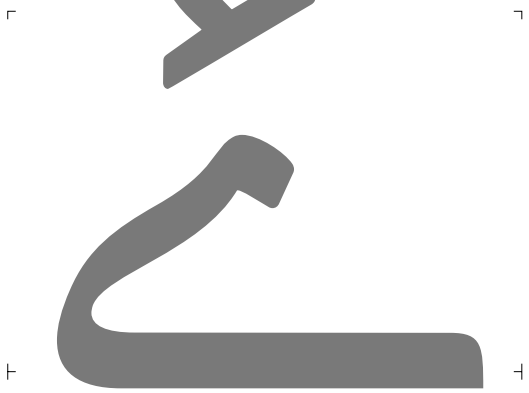

yehbarreeHamzaabove-ar.isol

FBBO

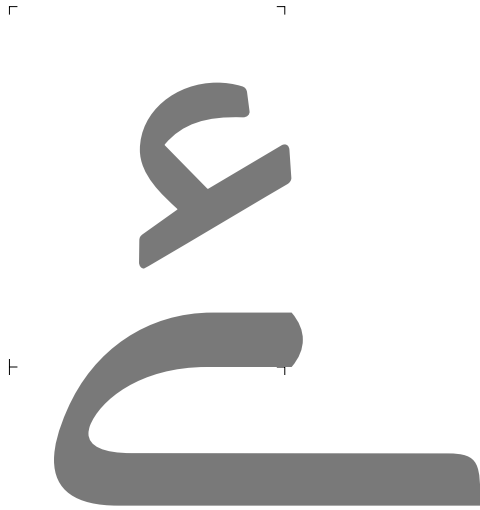

yehbarreeHamzaabove-ar.fina FBB1



ae-ar

06D5

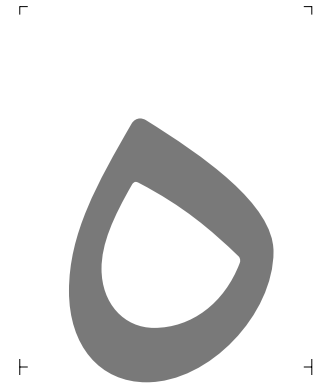

ae-ar.isol

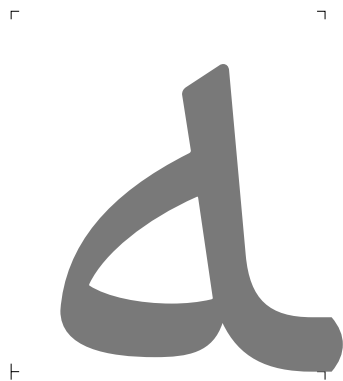

ae-ar.fina



kashida-ar

0640

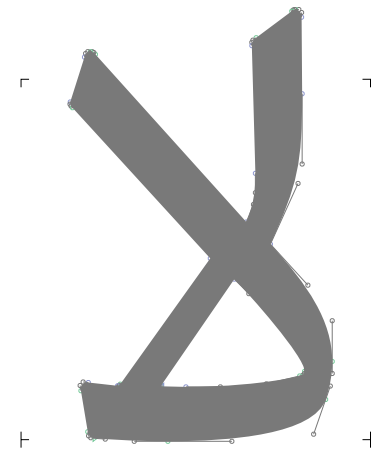

lam_alef-ar

FEFB

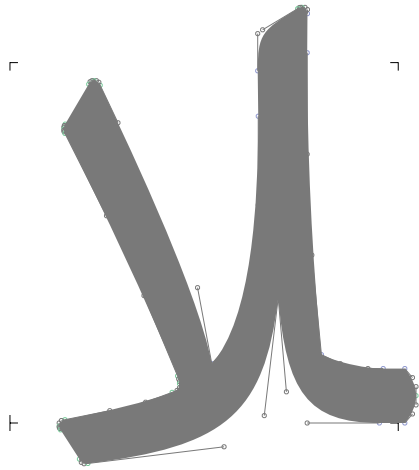

lam_alef-ar.fina

FEFC

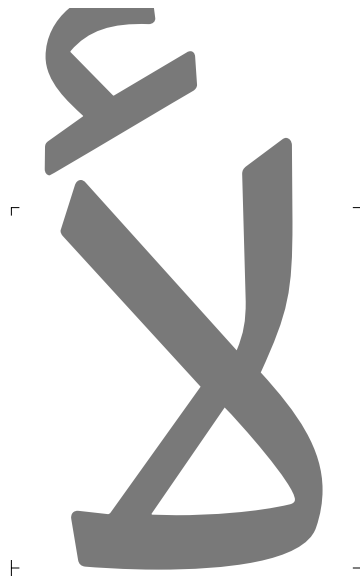

lam_alefHamzaabove-ar

FEF7

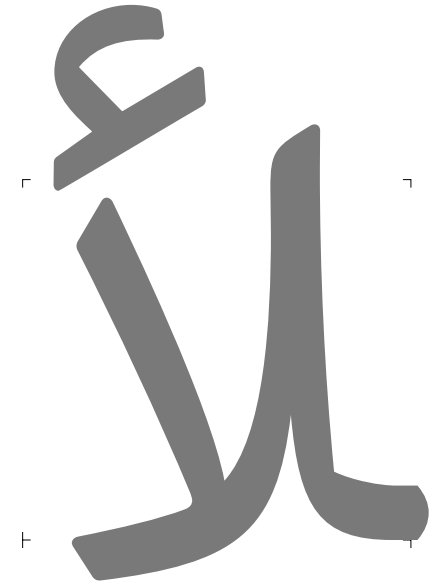

lam_alefHamzaabove-ar.fina

FEF8

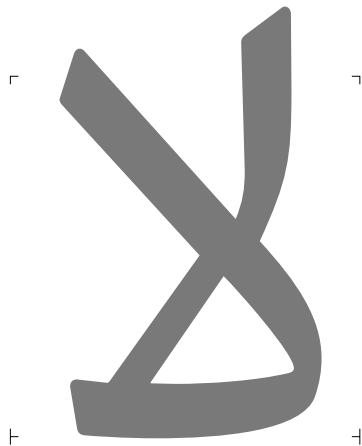

lam_alefHamzabelow-ar

FEF9

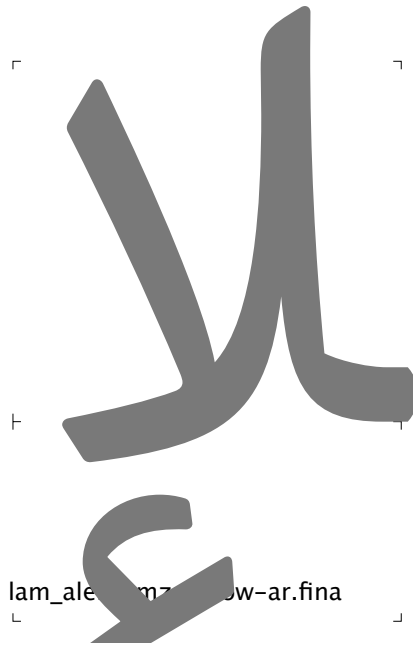

lam_alefHamzabelow-ar.fina

FEFA

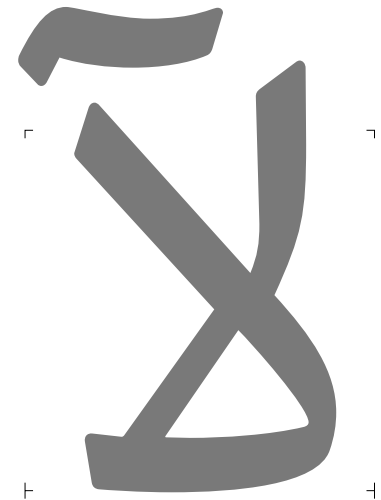

lam_alefMadda-ar

FEF5

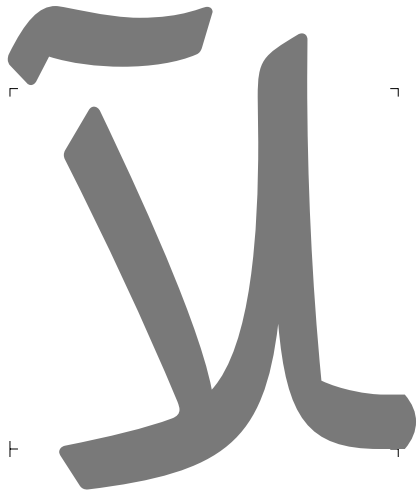

lam_alefMadda-ar.fina



lam_alefWasla-ar

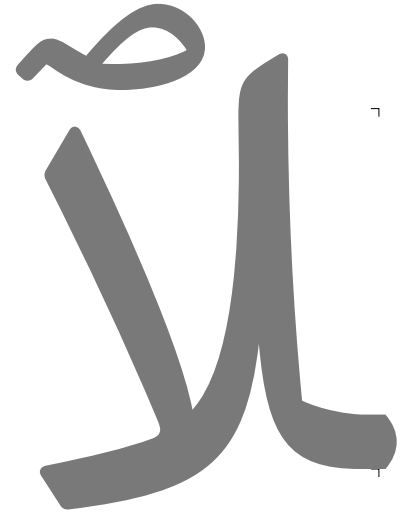

lam_alefWasla-ar.fina

FEF6

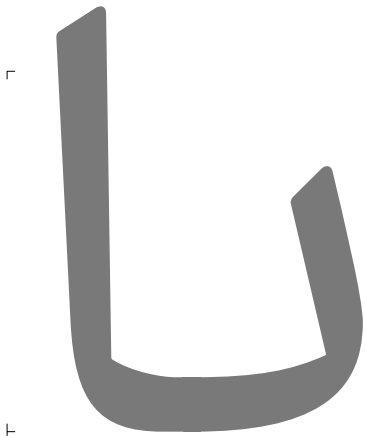

beh_alef-ar

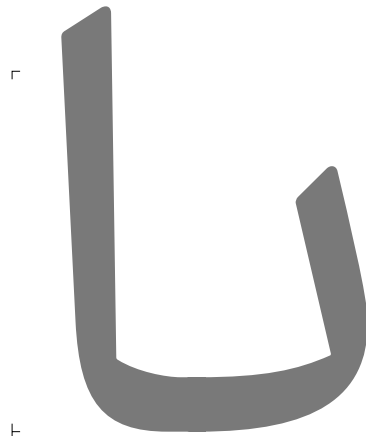

beh_alef-ar.isol

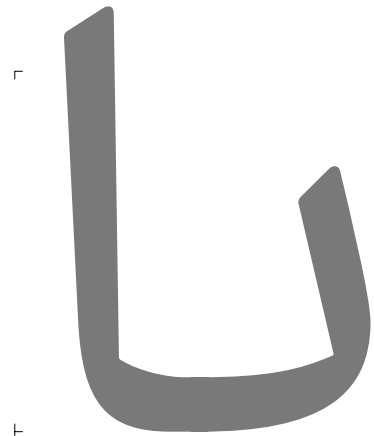

peh_a

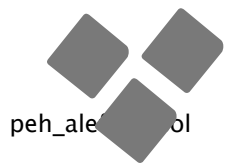
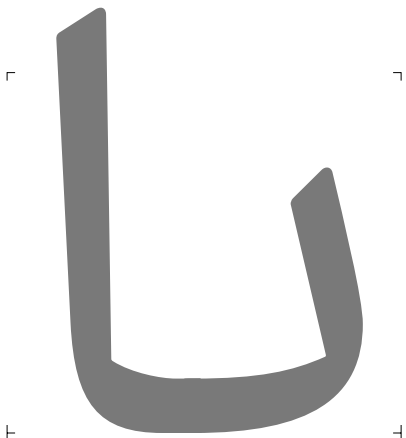

peh_alef-ar

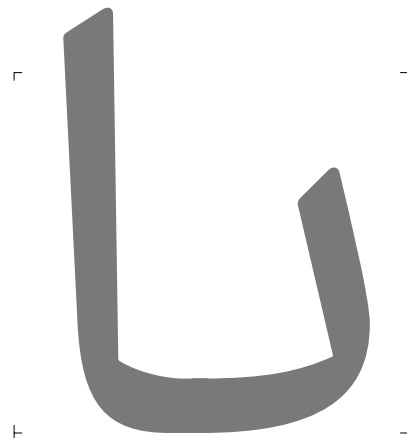

yeh_alef-ar

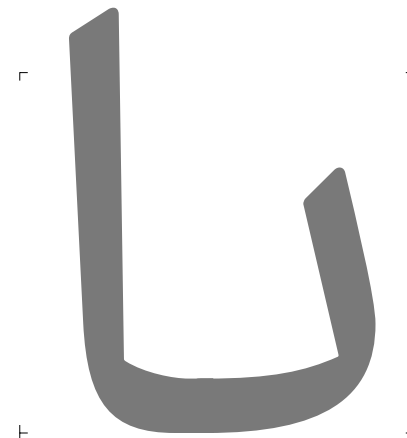

yeh_alef-ar.isol

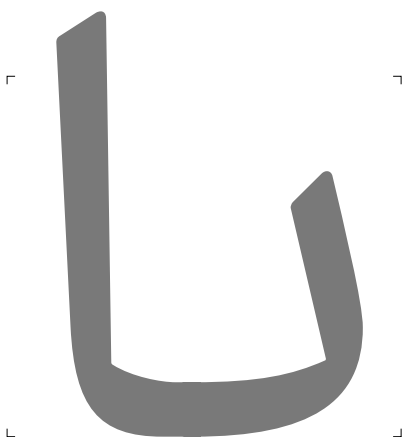

yeh-farsi_alef-ar

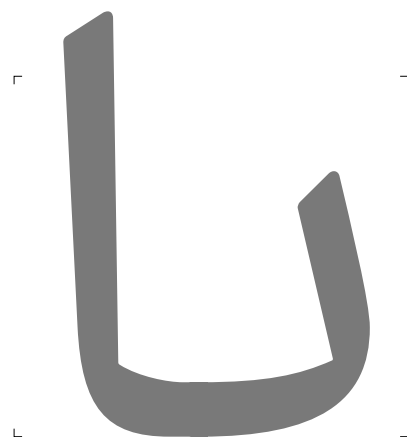

yeh-farsi_alef-ar.isol

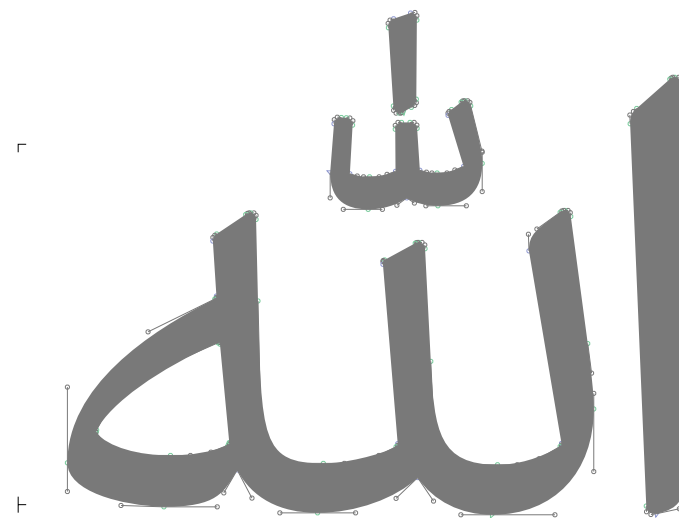

allah-ar

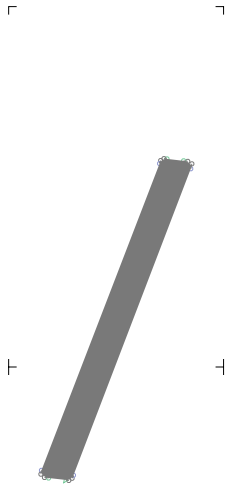

decimalseparator-ar

066B

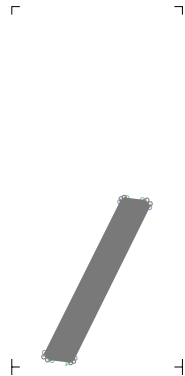

thousandseparator-ar

066C

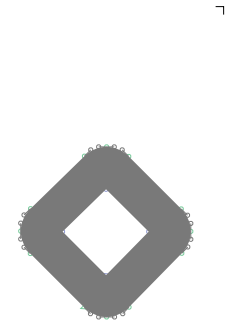

zero-ar

0660

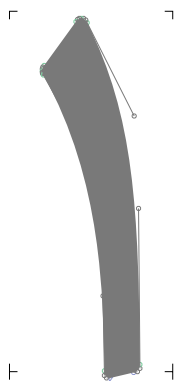

one-ar

0661

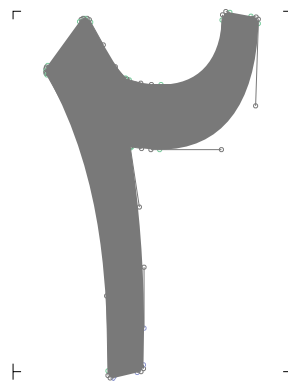

two-ar

0662

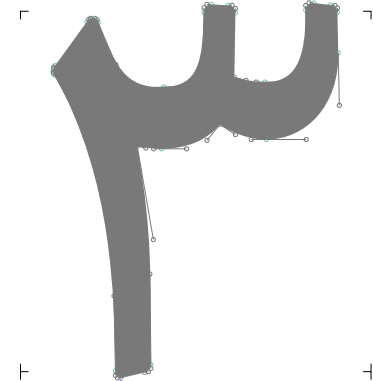

three-ar

0663



four-ar

0664

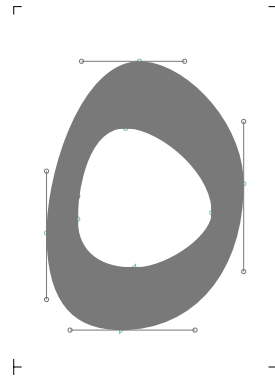

five-ar

0665

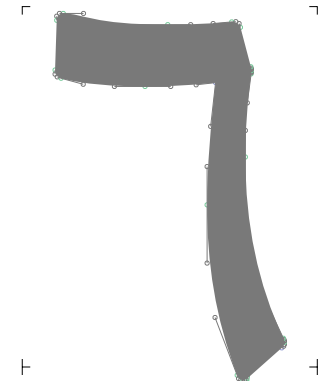

six-ar

0666

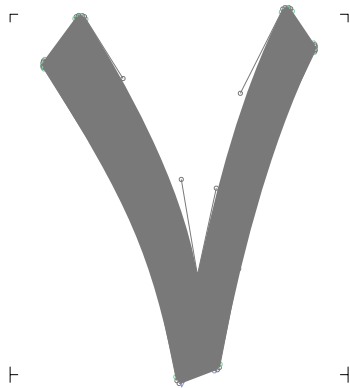

seven-ar

0667

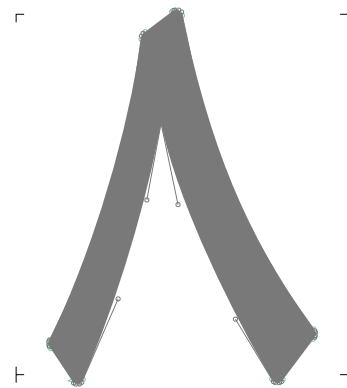

eight-ar

0668

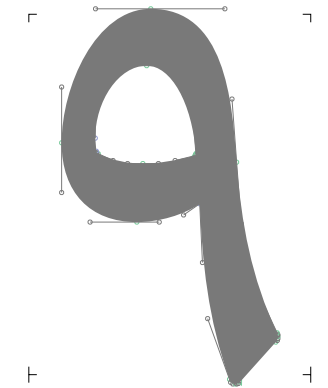

nine-ar

0669

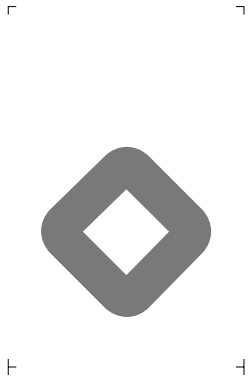

zero-persian

06F0

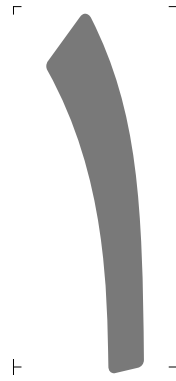

one-persian

06F1

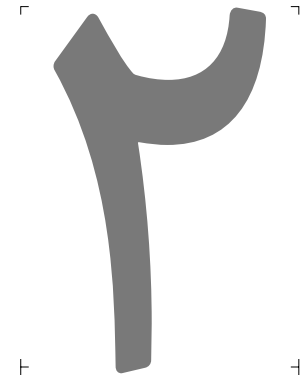

two-persian

06F2

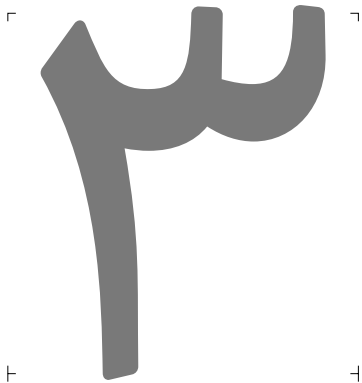

three-persian

06F3

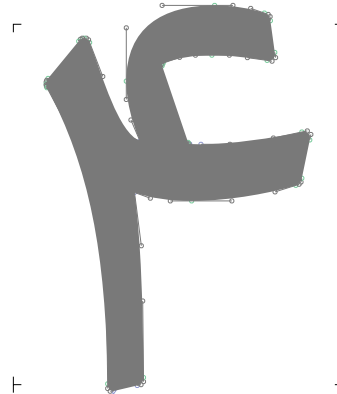

four-persian

06F4

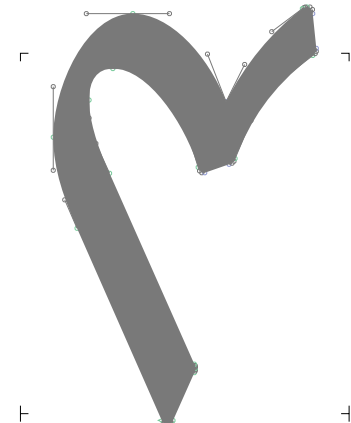

four-persian.urdu

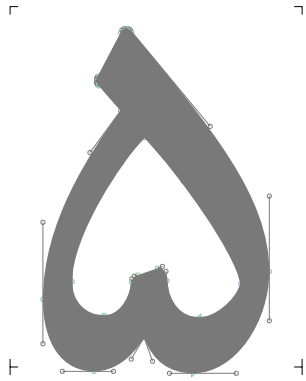

five-persian

06F5

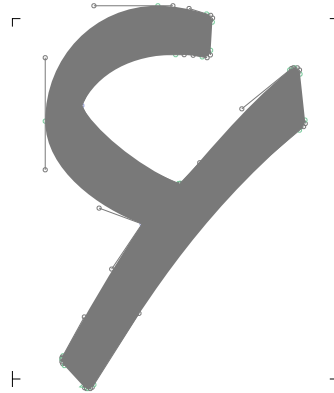

six-persian

06F6

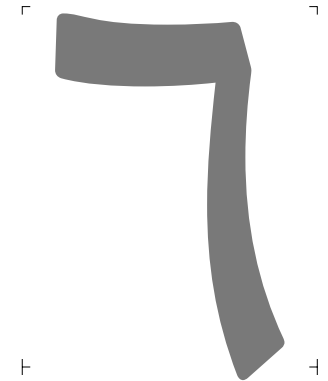

six-persian.urdu



seven-persian

06F7

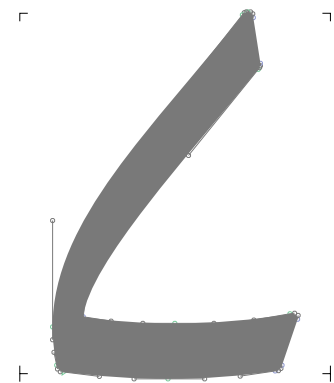

seven-persian.urdu

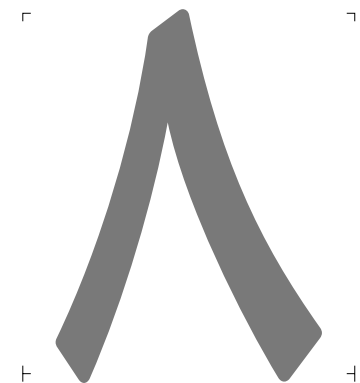

eight-persian

06F8

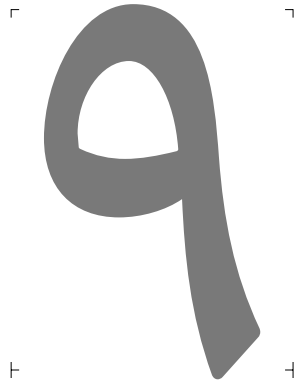

nine-persian

06F9

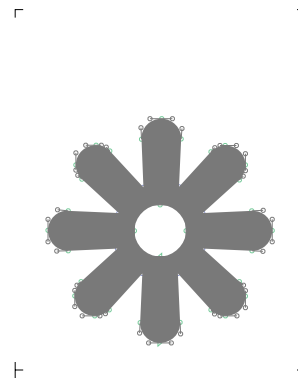

asterisk

002A

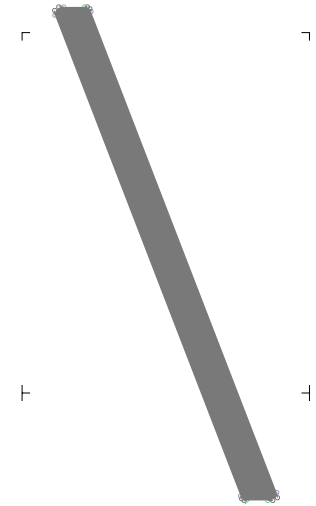

backslash

005C

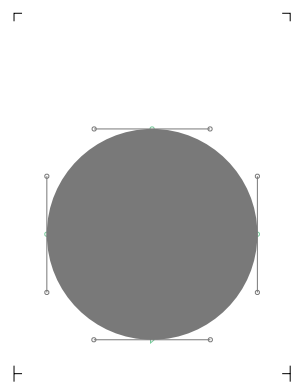

bullet

2022

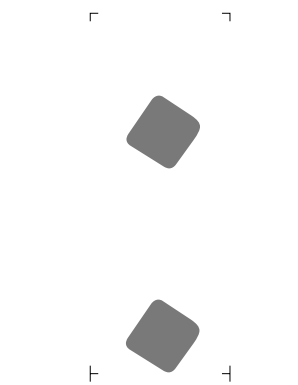

colon

003A

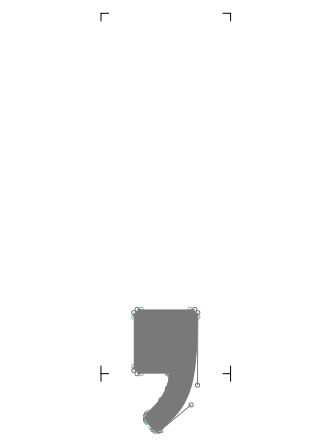

comma

002C

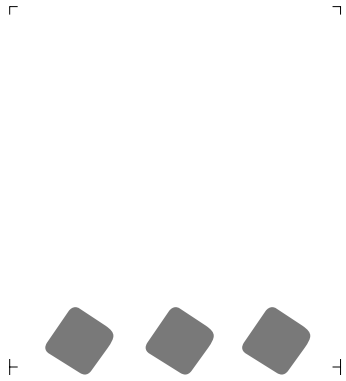

ellipsis

2026

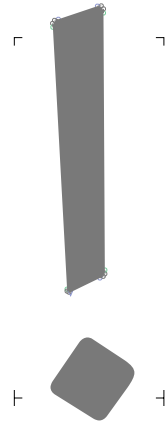

exclam

0021

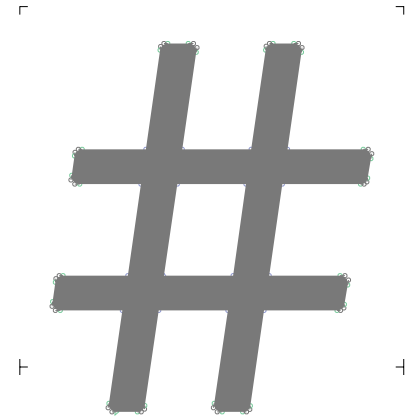

numbersign

0023



period

002E



quotedbl

0022

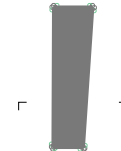

quotesingle

0027

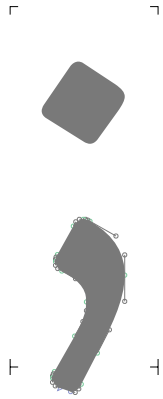

semicolon

003B

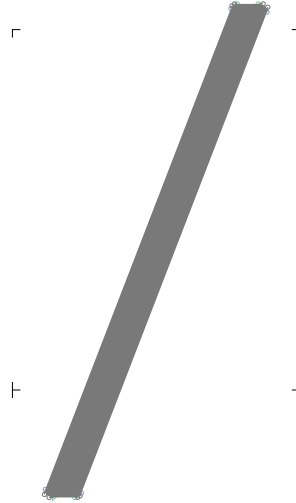

slash

002F

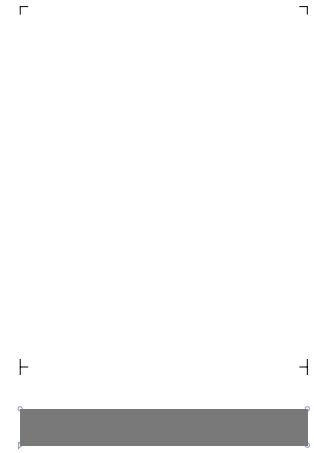

underscore

005F

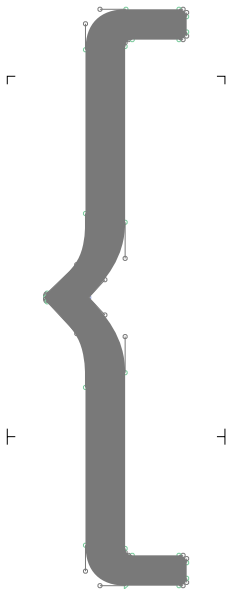

braceleft

007B

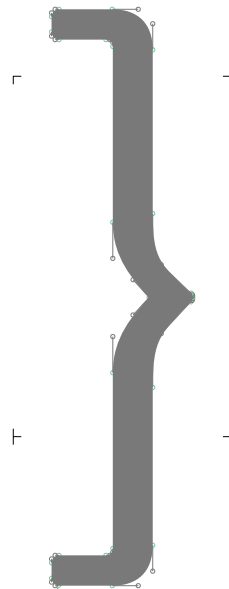

braceright

007D

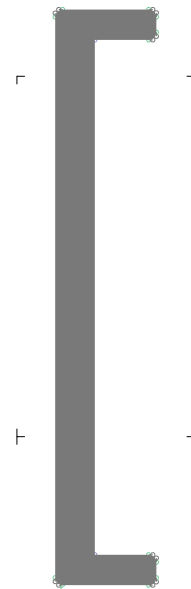

bracketleft

005B

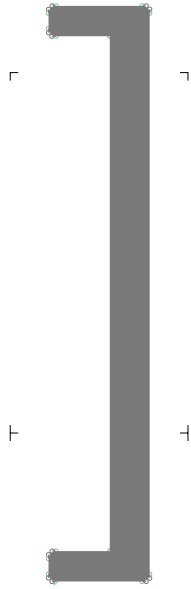

bracketright

005D

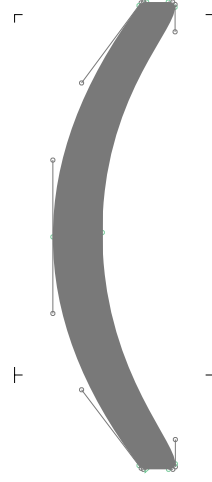

parenleft

0028

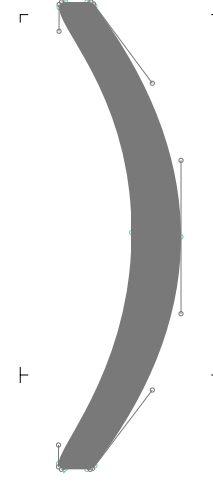

parenright

0029



hyphen

002D



hyphentwo

2010

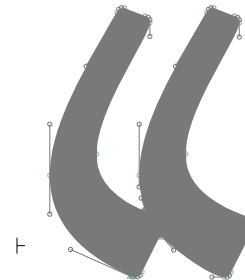

guillemetleft

00AB

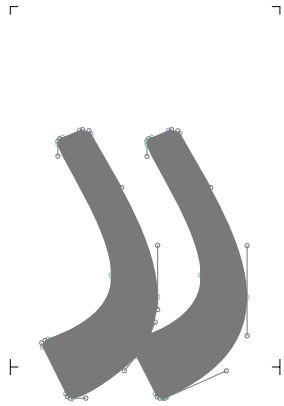

guillemetright

00BB

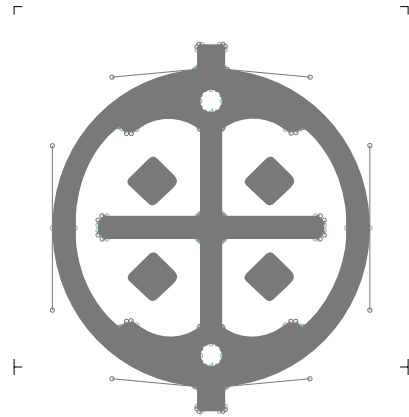

asteriskArt-ar

06DE

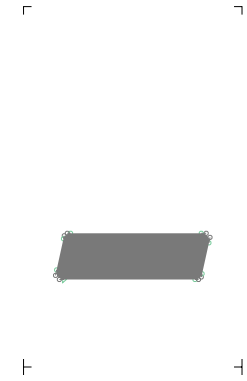

fullstop-ar

06D4

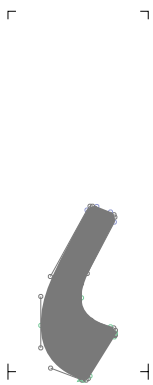

comma-ar

060C



semicolon-ar

061B

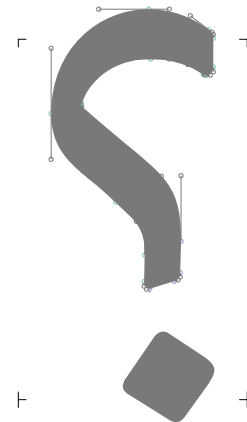

question-ar

061F

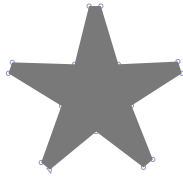

asterisk-ar

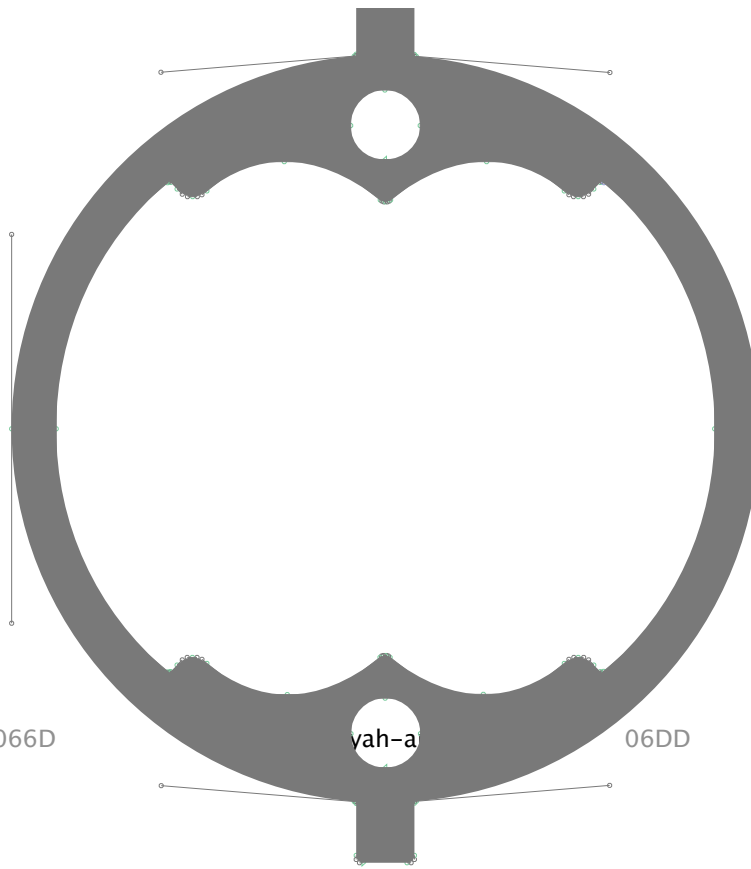

066D

yah-a

06DD

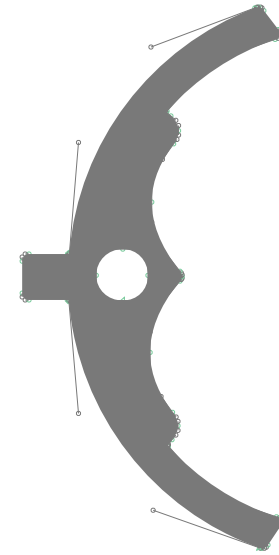

parenleft-ar

FD3E

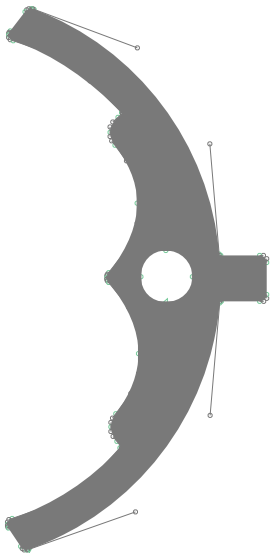

parenright-ar

FD3F

space

0020

nbspace

00A0

⸮

⸮

⸮

+

+

+

zerowidthspace

200B

lefttorightmark

200E

righttoleftmark

200F

⸮

⸮

⸮

⸮

⸮

⸮

⸮

+

H

⸮

⸮

zerowidthjoiner

200D

zerowidthnonjoiner

200C

CR

000D

⸮

⸮

⸮

⸮

⤵

⤵

⤵

+

+

+

lefttorightembedding

202A

lefttorightoverride

202D

popdirectionalformatting

202C

⤵

⤵

⤵

⤵

⤵

⤵

+

+

+

righttoleftembedding

202B

righttoleftoverride

202E

zeroWidthNoBreakSpace

FEFF

⤵

⤵

⤵

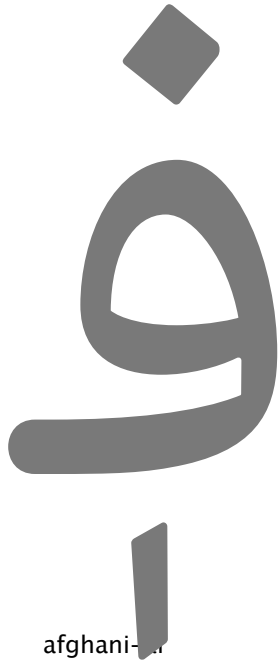

afghani-

060B

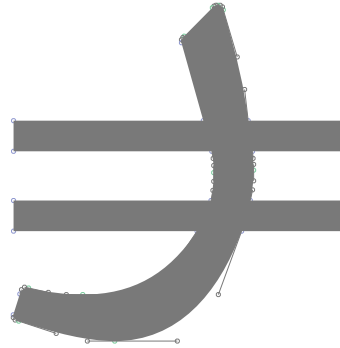

rial

FDFC

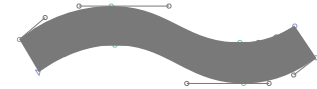

asciitilde

007E

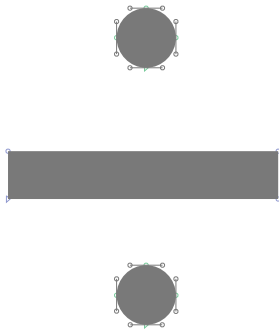

divide

00F7



equal

003D

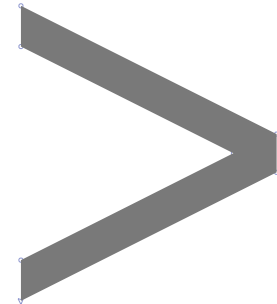

greater

003E

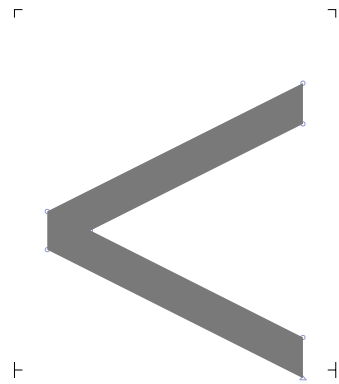

less

003C

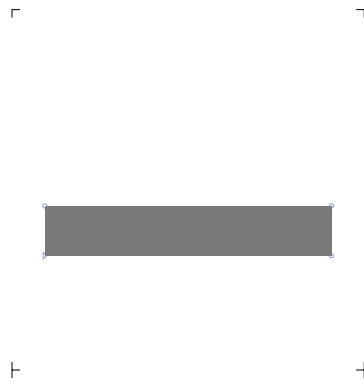

minus

2212

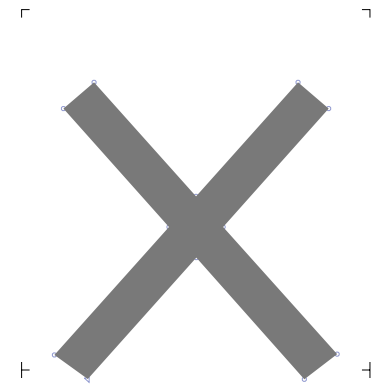

multiply

00D7

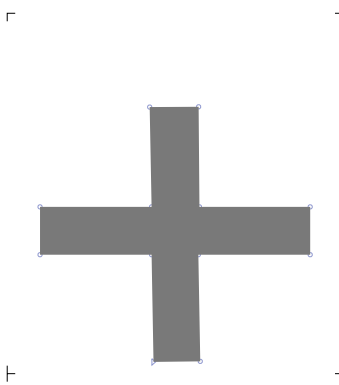

plus

002B

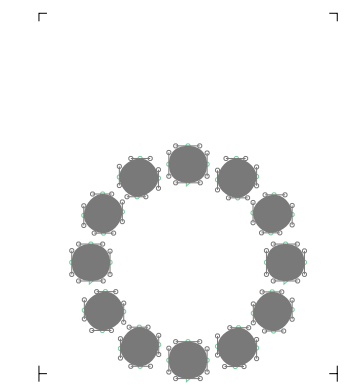

dottedCircle

25CC

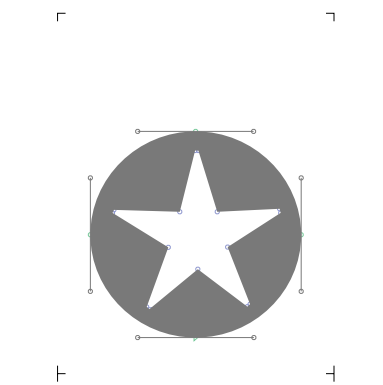

whiteStar.circled

272A

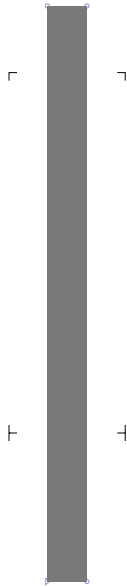

bar

007C

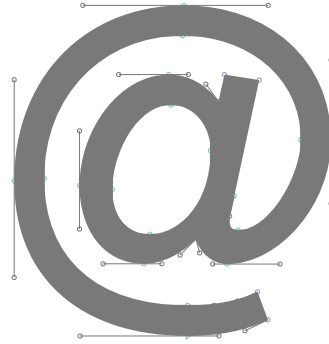

at

0040

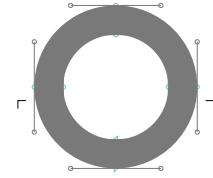

degree

00B0



asciicircum

005E

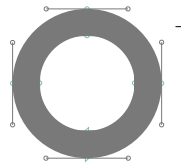

lowringmod

02F3

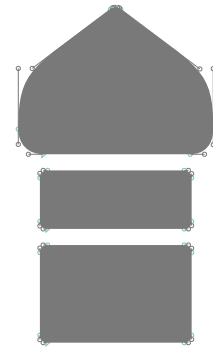

sajdah-ar

06E9

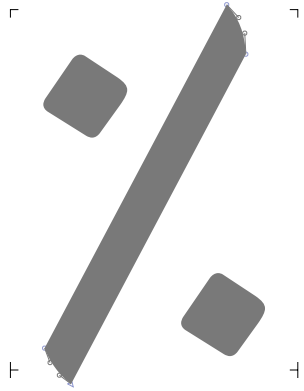

percent-ar

066A

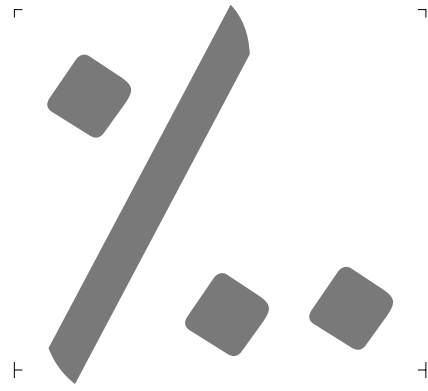

perthousand-ar

0609



pertenthousand-ar

060A

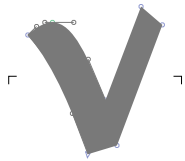

caron

02C7

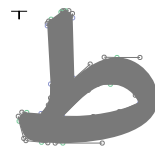

tahabove-ar

0615

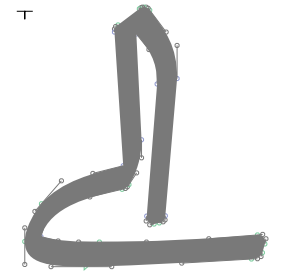

alefLamYehabove-ar

0616

T



+

dotabove-ar

±

FBB2

T



+

dotbelow-ar

±

FBB3

T



+

dotcenter-ar

±

T



+

twodotsverticalabove-ar

±

FBBD

T



+

twodotsverticalbelow-ar

±

FBBE

T



+

twodotshorizontalabove-ar

±

FBB4

T

T

T



+

+

+

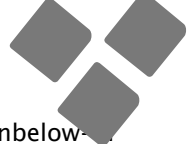

twodotshorizontalbelow-ar

FBB5

threedotsdownabove-ar

FBB8

threedotsdownbelow-ar

FBB9

⊥

⊥

⊥

T

T

T



+

+

+

threedotsdowncenter-ar

threedotsupabove-ar

FBB6

threedotsupbelow-ar

FBB7

⊥

⊥

⊥



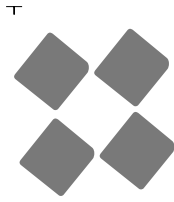

T

+

fourdotsabove-ar

⊥

FBBA

T

+

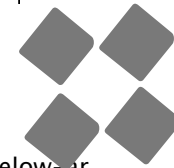

fourdotsbelow-ar

⊥

FBBB

T

+



ringbelow-ar

⊥

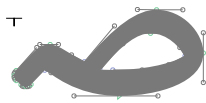

T

+

wasla-ar

⊥

T

+



ringcenter-ar

⊥



T

+

alefabove-ar

⊥

T

T

T



+

+

+



+

+

alefbelow-ar

0656

hamzaabove-ar

0654

hamzabelow

0655

T

T

T

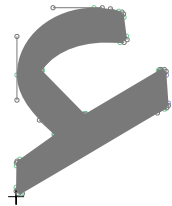

+

+

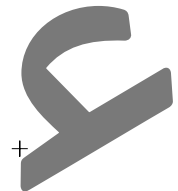
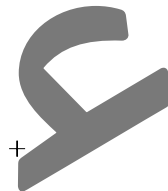
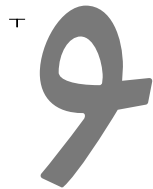

hamzacementer-ar

hamzaaboveDamma-ar

hamzaaboveDammatan-ar



hamzaaboveFatha-ar



hamzaaboveFathatan-ar

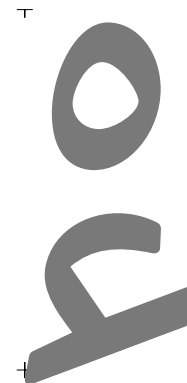

hamzaaboveSukun-ar



hamzabelowFatha-ar

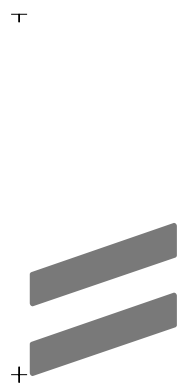

hamzabelowFathatan-ar

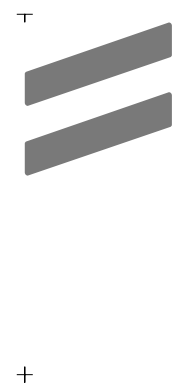

fathatan-ar



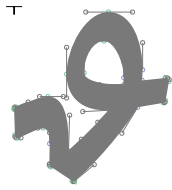

+

dammatan-ar

⊥

064C

T

+

kasratan

⊥

064D

T

+

fatha-ar

⊥

064E



+

damma-ar

⊥

064F

T

+

kasra-a

⊥

0650

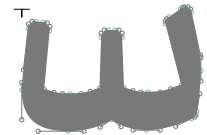

+

shadda-ar

⊥

0651

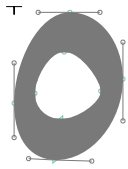

+

sukun-ar

±

0652

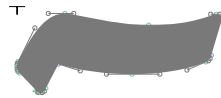

+

madda-ar

±

0653

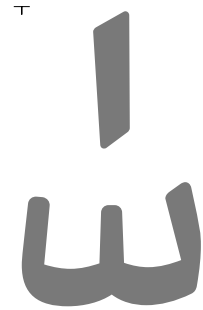

+

shaddaAlefabove-ar

±



+

shaddaDamma-ar

±



+

shaddaDammatan-ar

±



+

shaddaFatha-ar

±



shaddaFathatan-ar

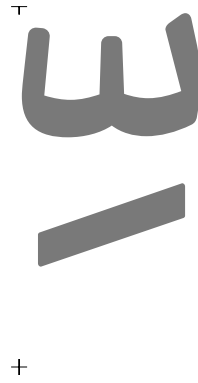

shaddaKasra-ar



shaddaKasratan-ar

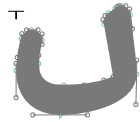

noonghunnaabove-ar



0658

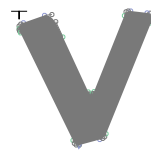

vabove-ar



065A



vbelow-ar



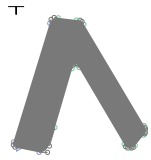

+

vinvertedabove-ar

⊥

065B

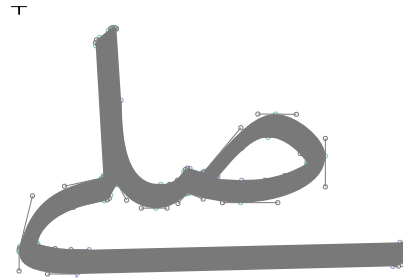

+

sadLamAlefMaksuraabove-ar

⊥

06D6

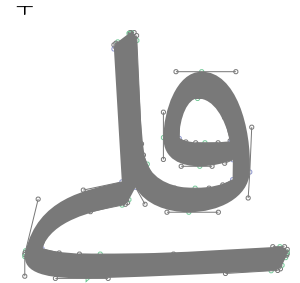

+

qafLamAlefMaksuraabove-ar

⊥

06D7

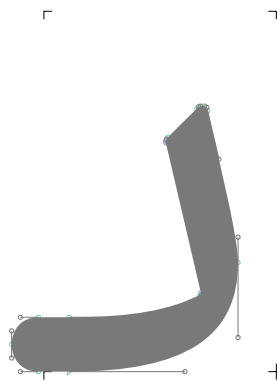

dotlessbeh2-ar.init

┌ └



+

kafche-ar

⊥