

Michel Paradis
McGill University

BILINGUAL APHASIA TEST

(FARSI VERSION)

STIMULUS BOOK

آزمون زبان پریشی برای دوزبانه ها

The development of the Bilingual Aphasia Test materials was supported by Grant MEQ 01-07-k (1976-1983) from the Quebec Ministry of Intergovernmental Affairs, Grant EQ 1660 (1980-1985) from the Quebec Ministry of Education FCAC Fund, and Grants 410-83-1028 (1984, 1985) and 410-88-0821 (1989-1991) from the Social Sciences and Humanities Research Council of Canada.

تصویرهای بخش تشخیص شنوایی گفتار

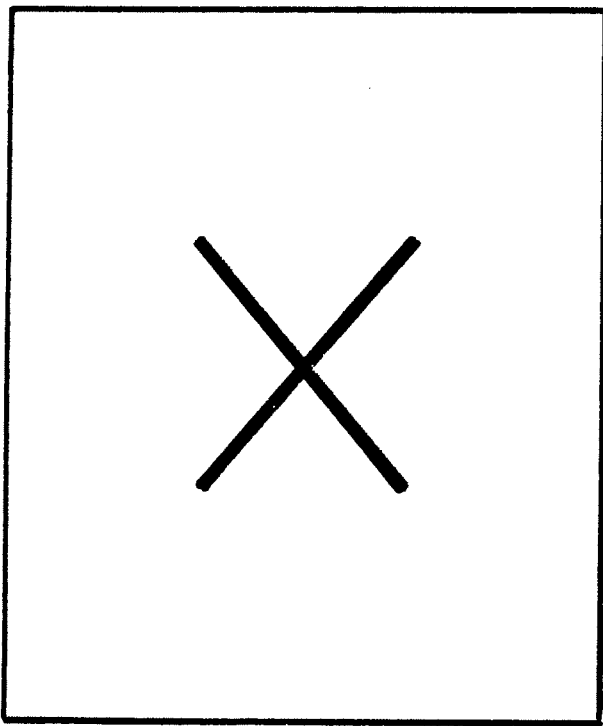

مثال

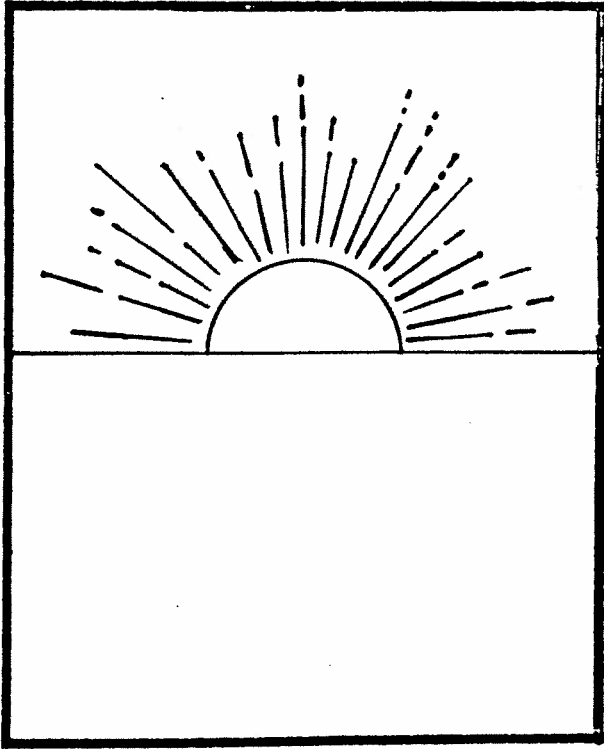

٢

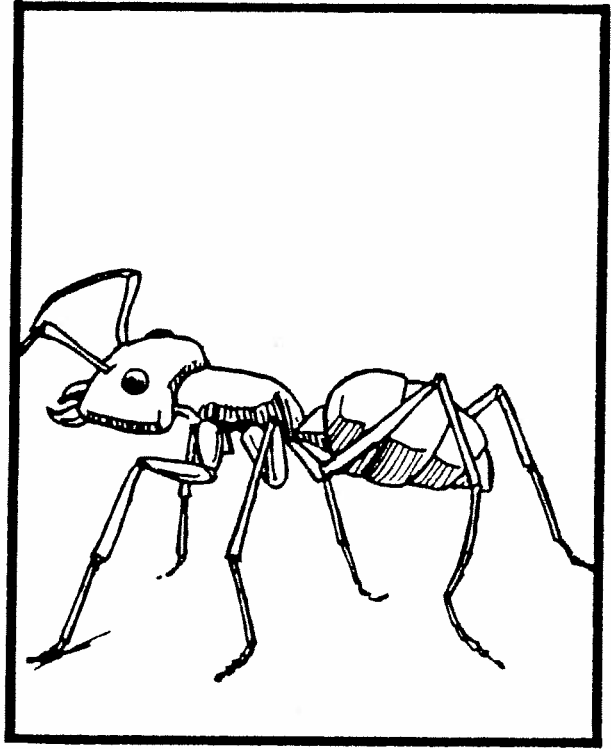

١

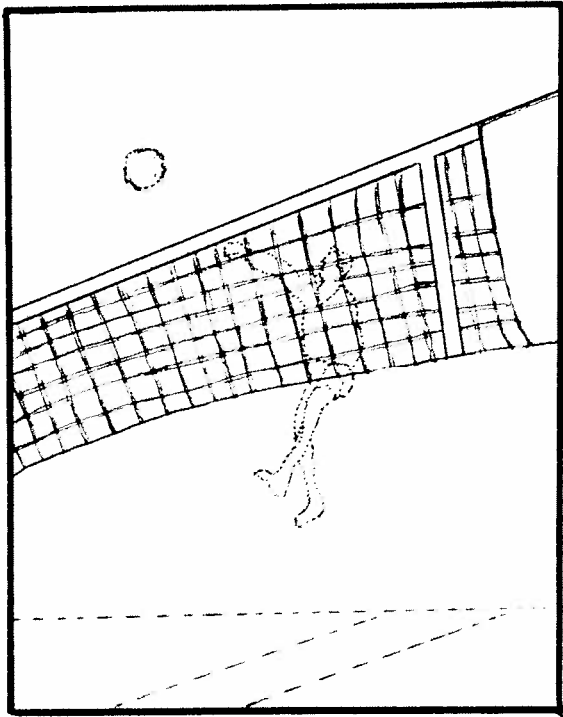

٤



٣

۲

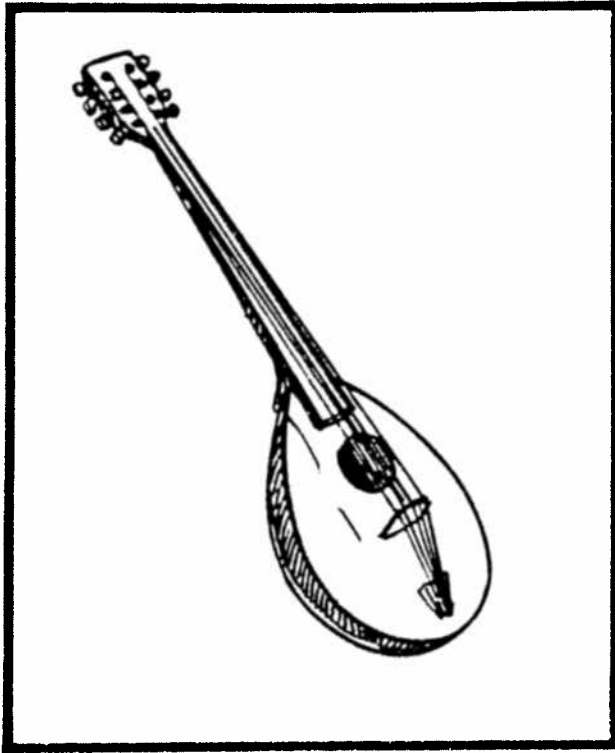

۱

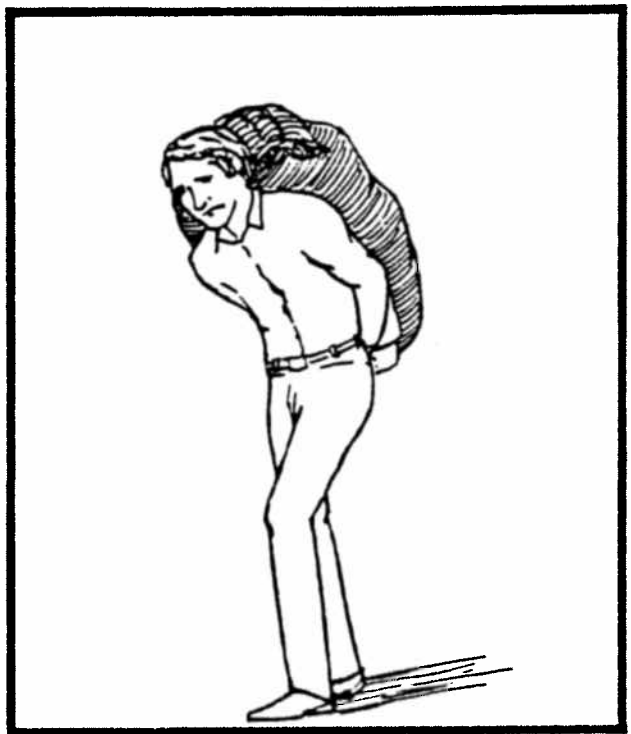

۴

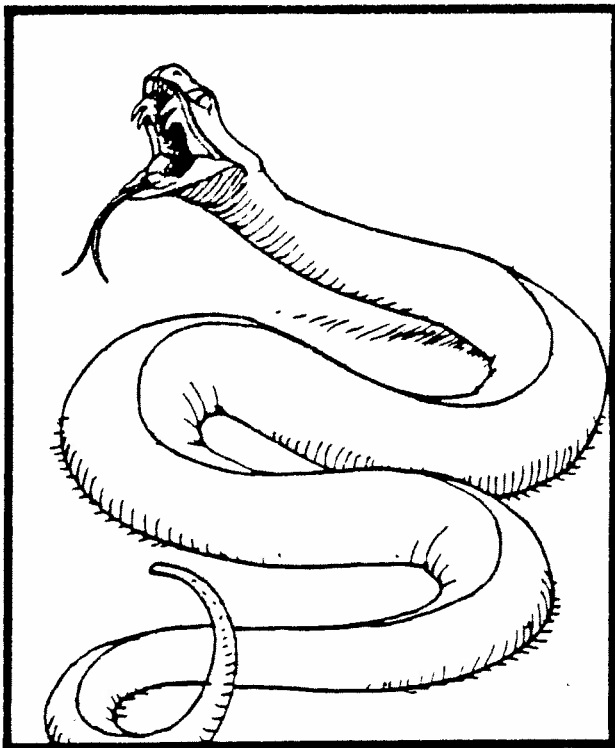

۲

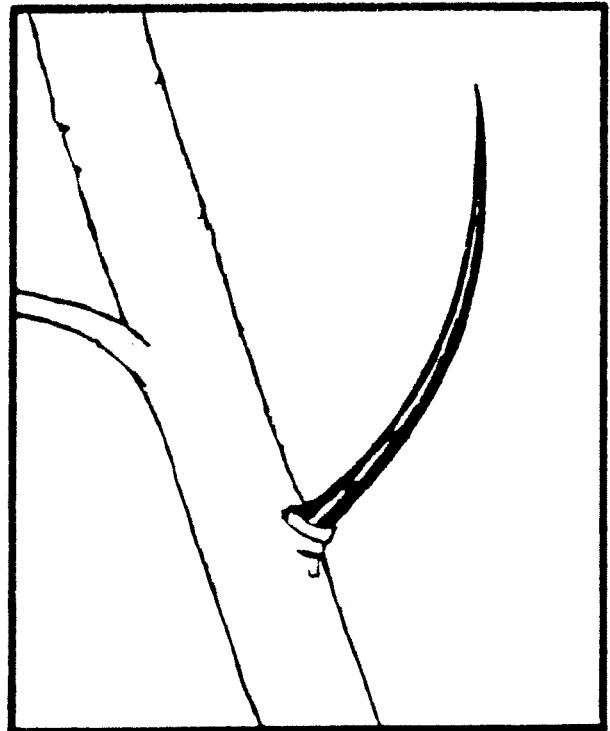

۴۸

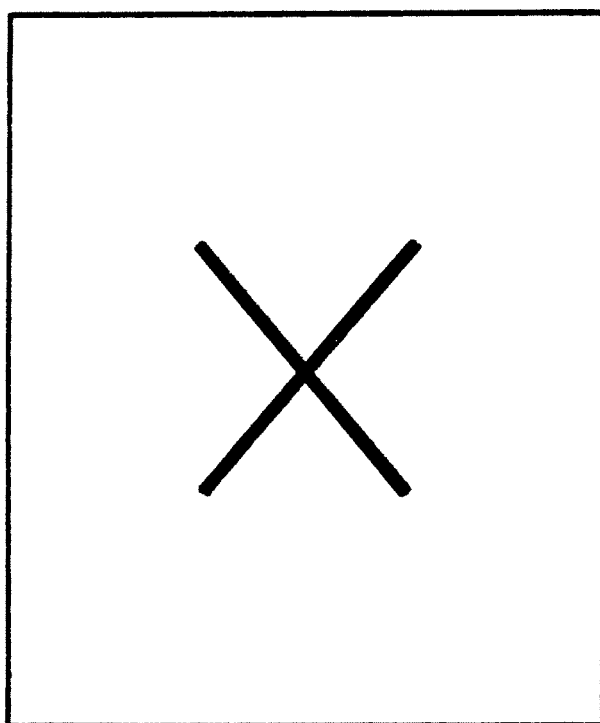

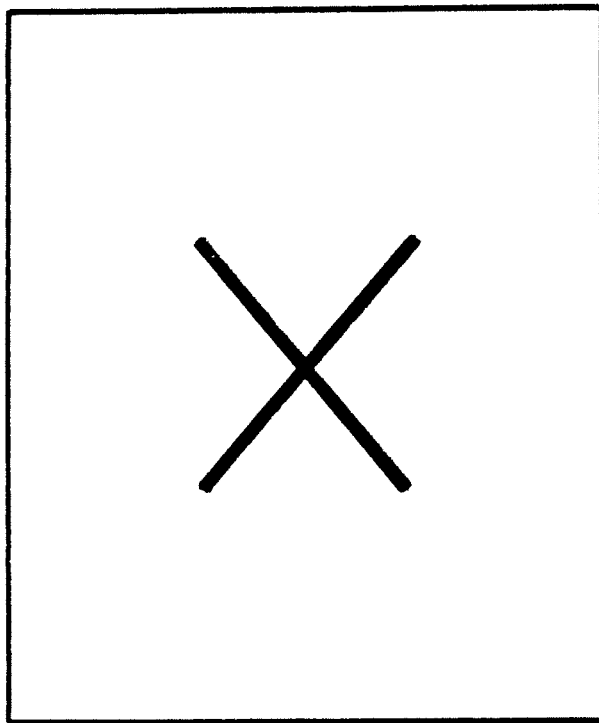

2

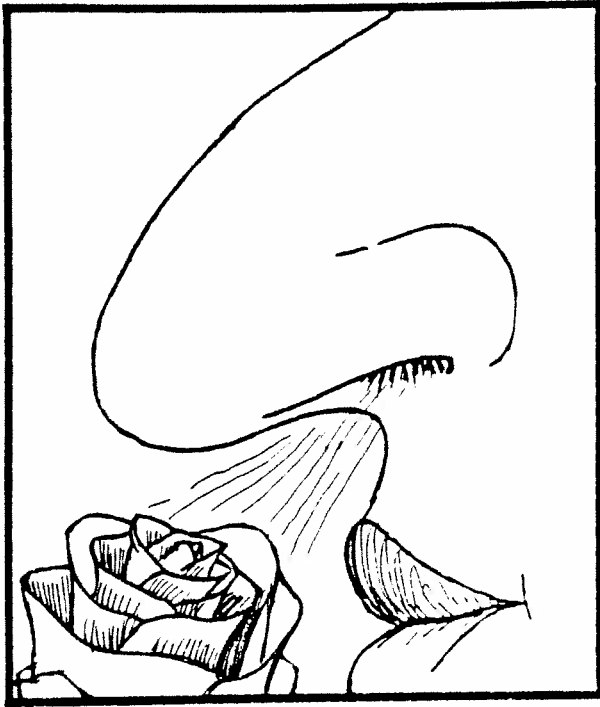

1

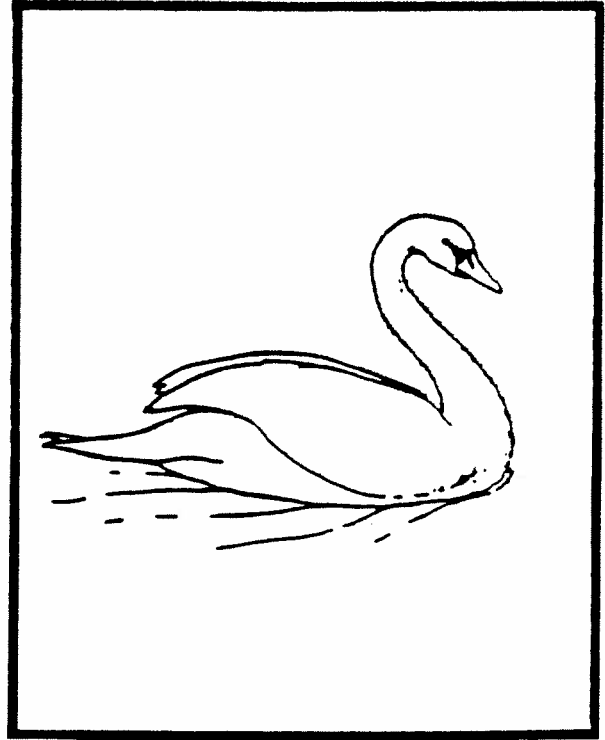

4



2

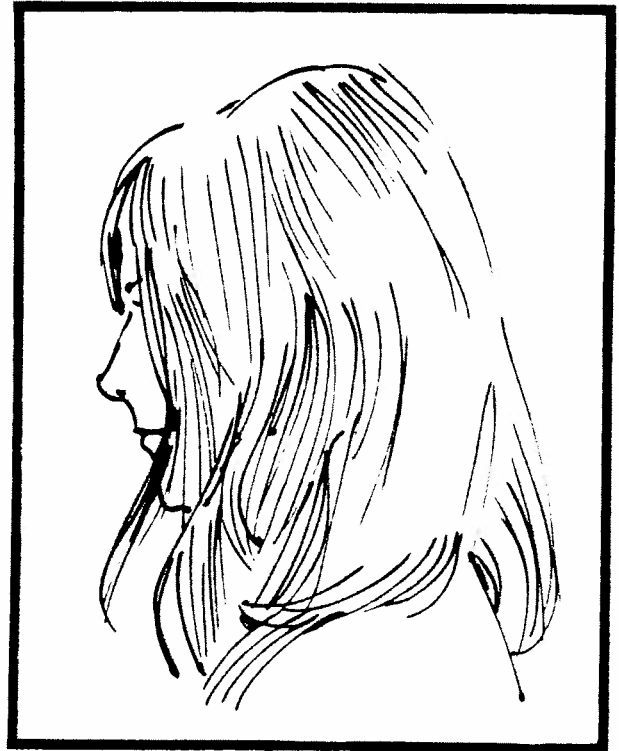

2

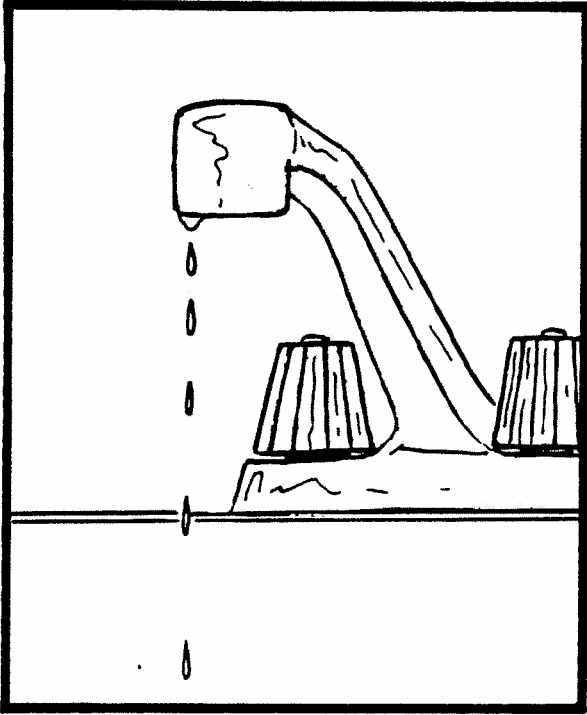

1

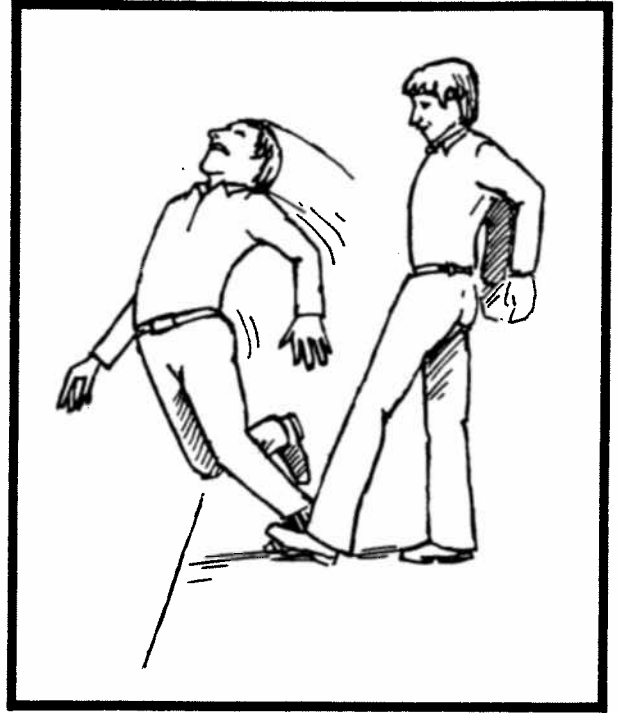

4

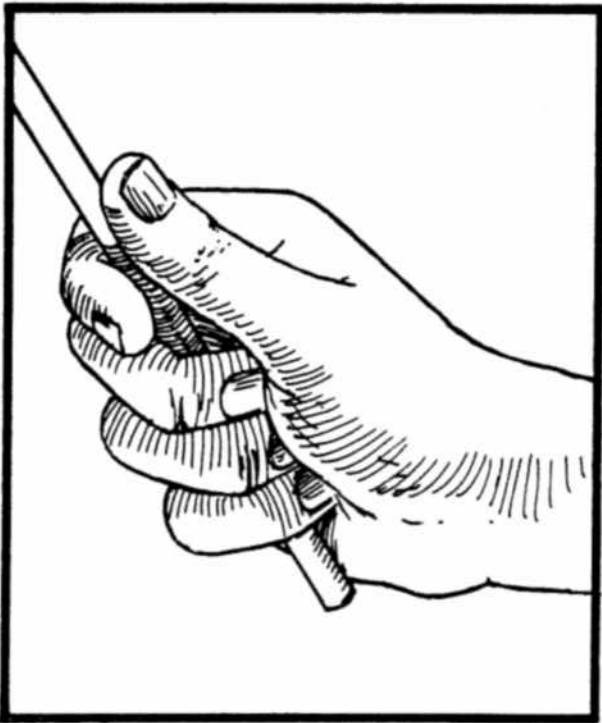

3

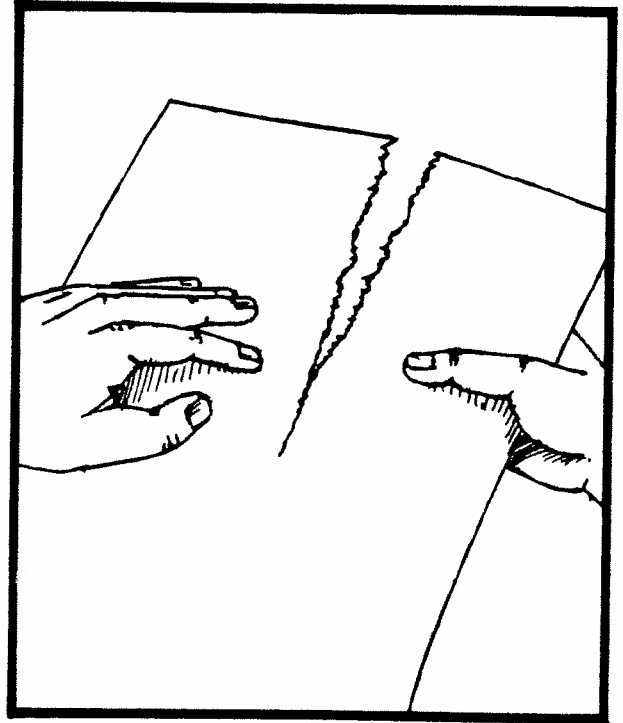

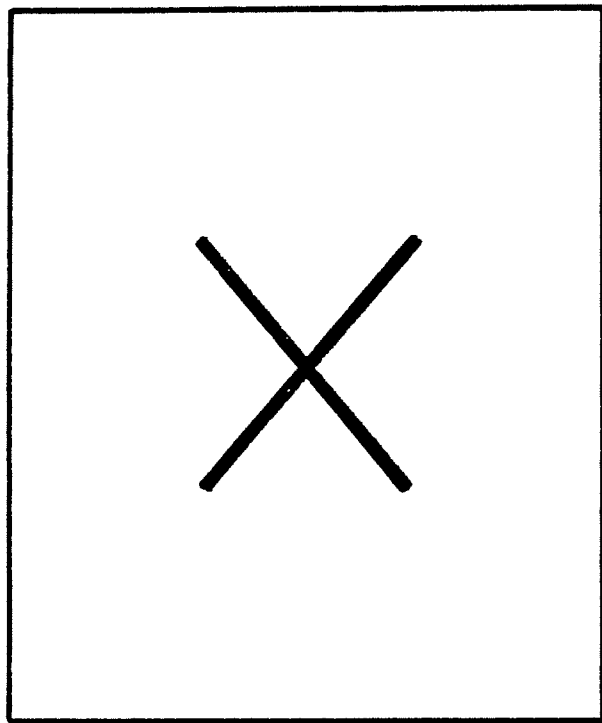

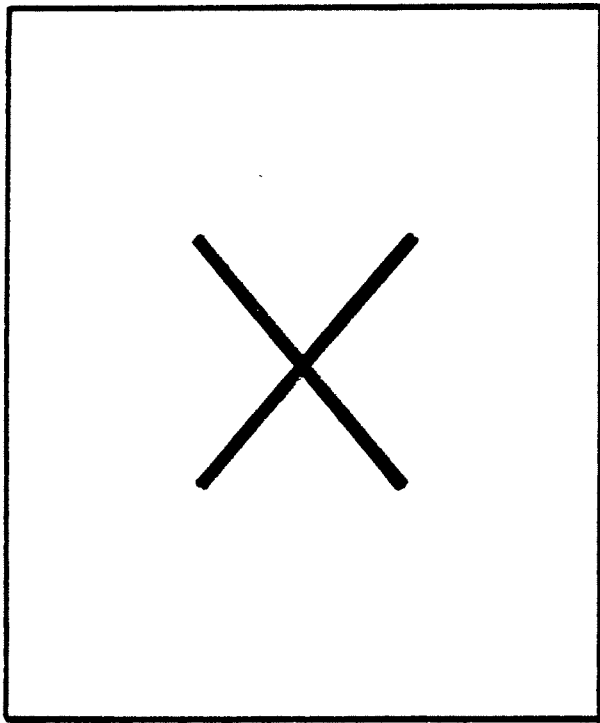

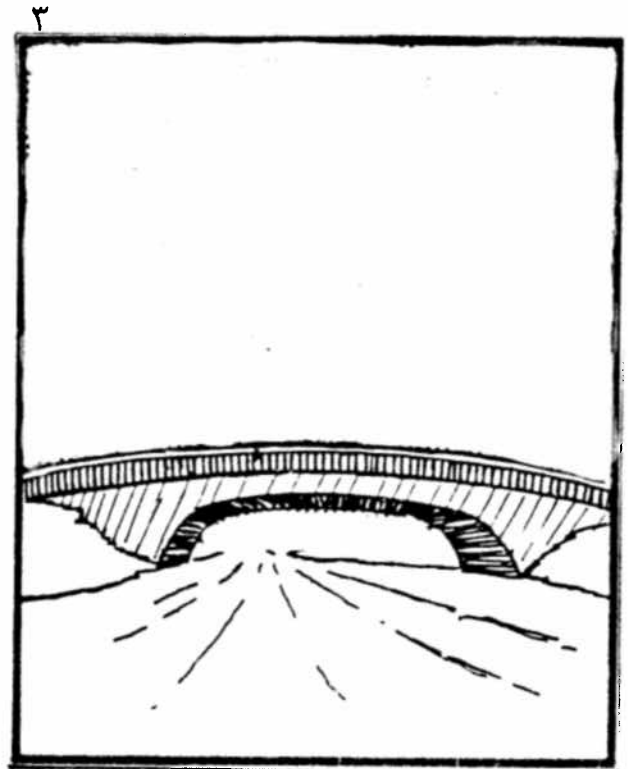
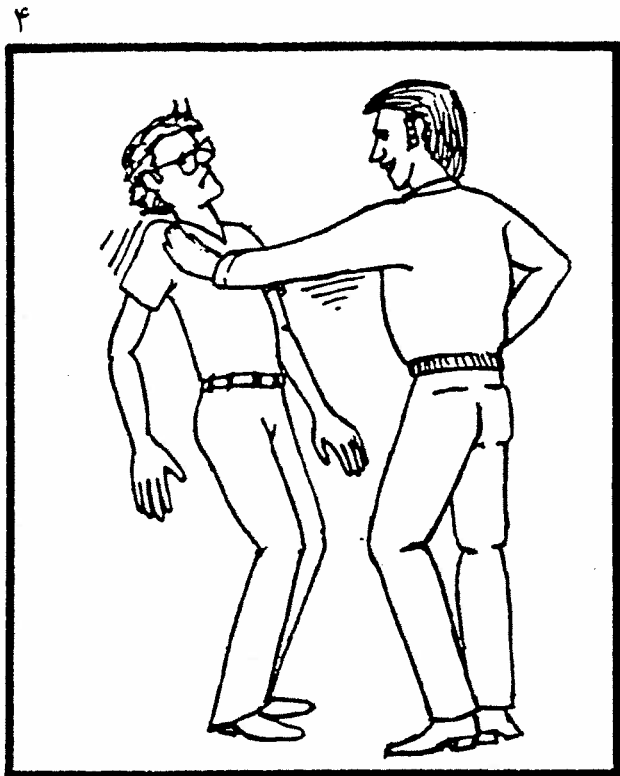
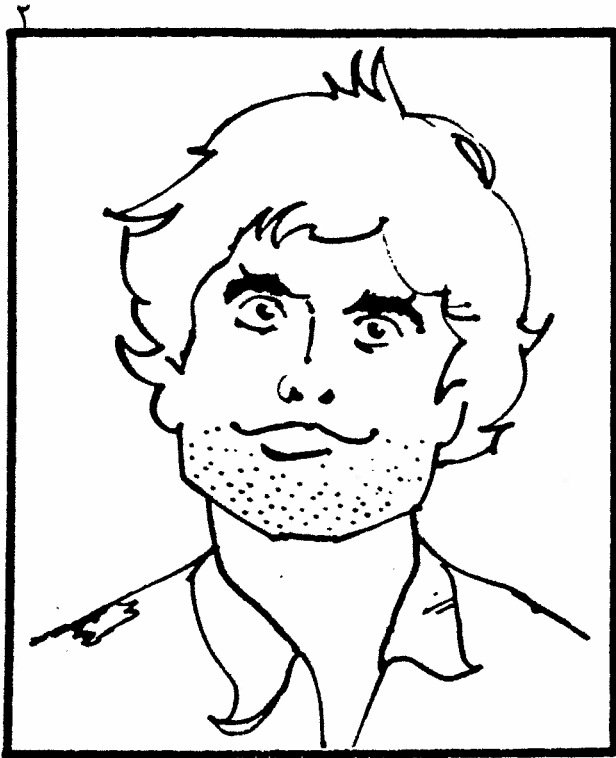

2

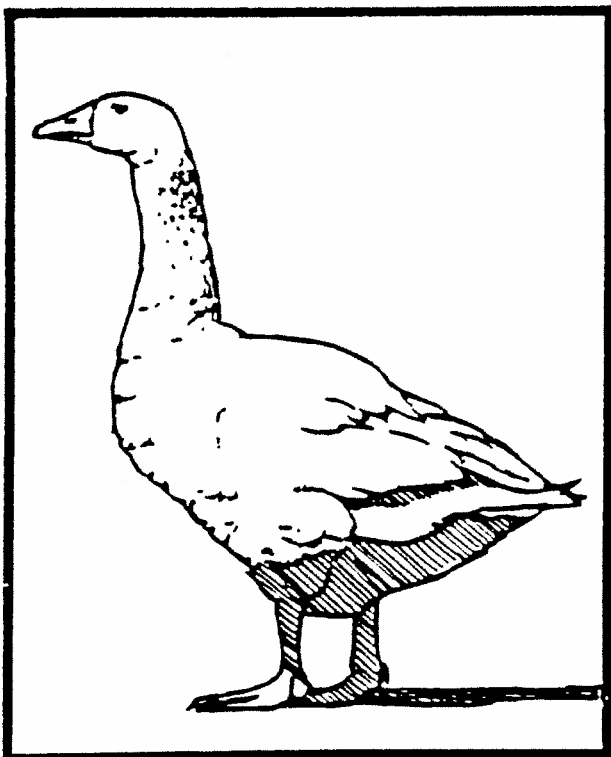

1



4

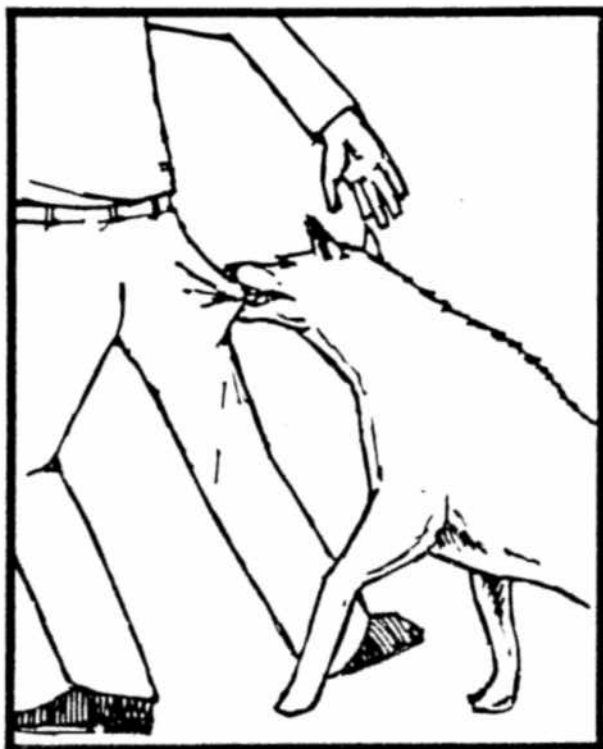

3

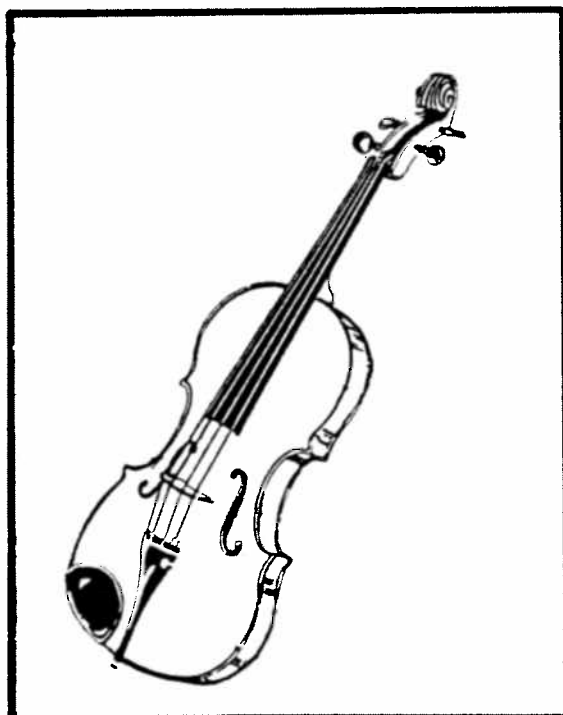

52

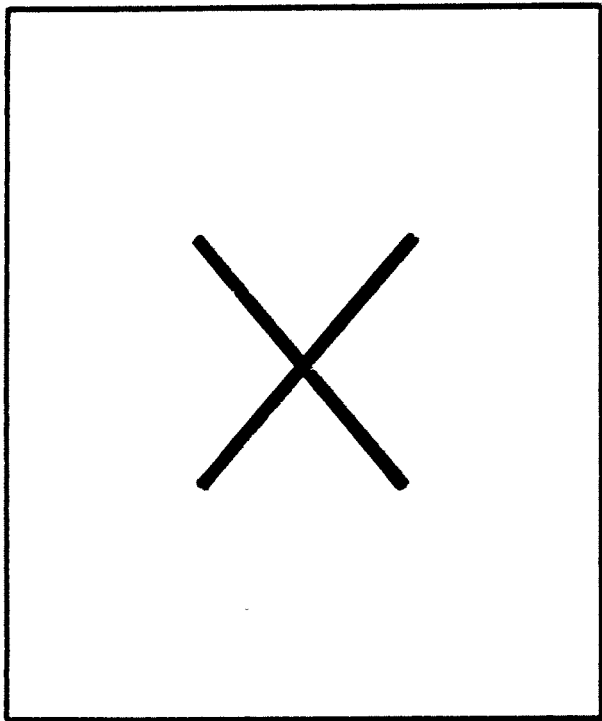

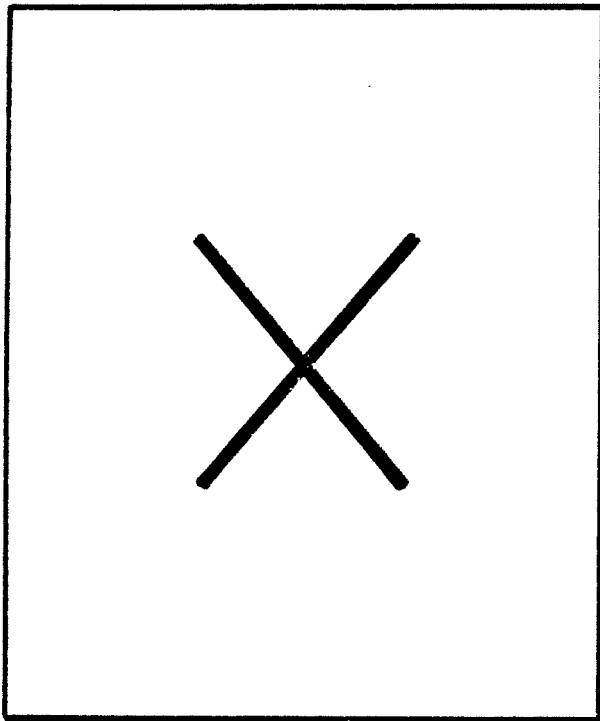

7

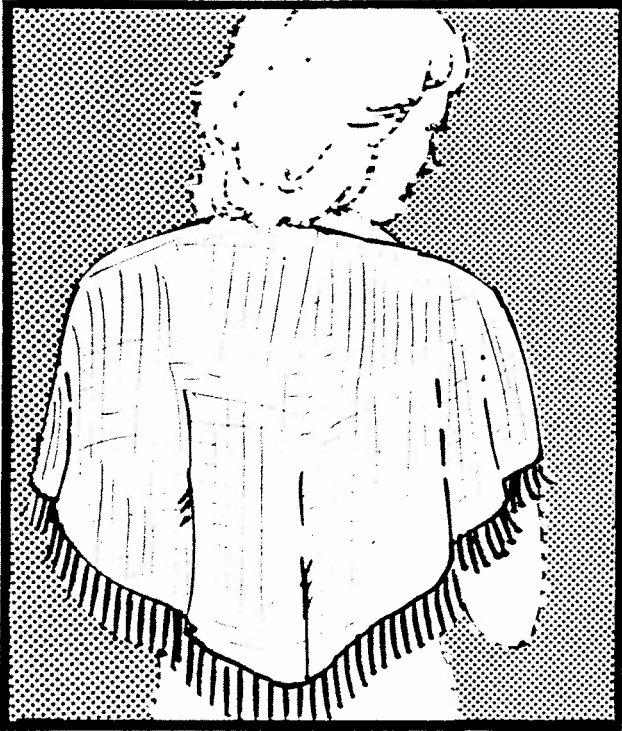

1

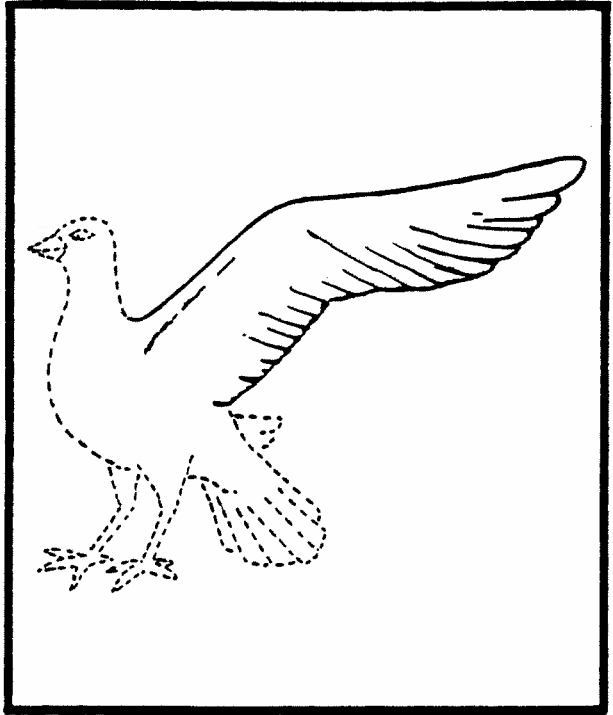

6

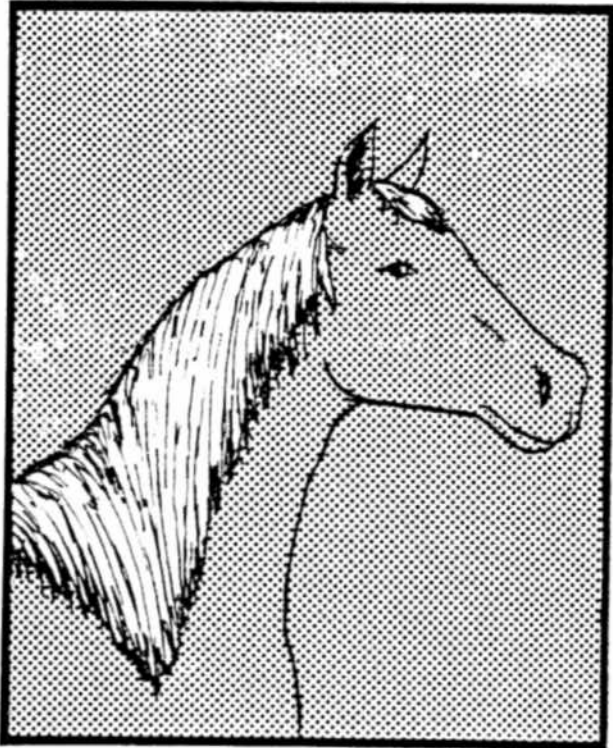

4

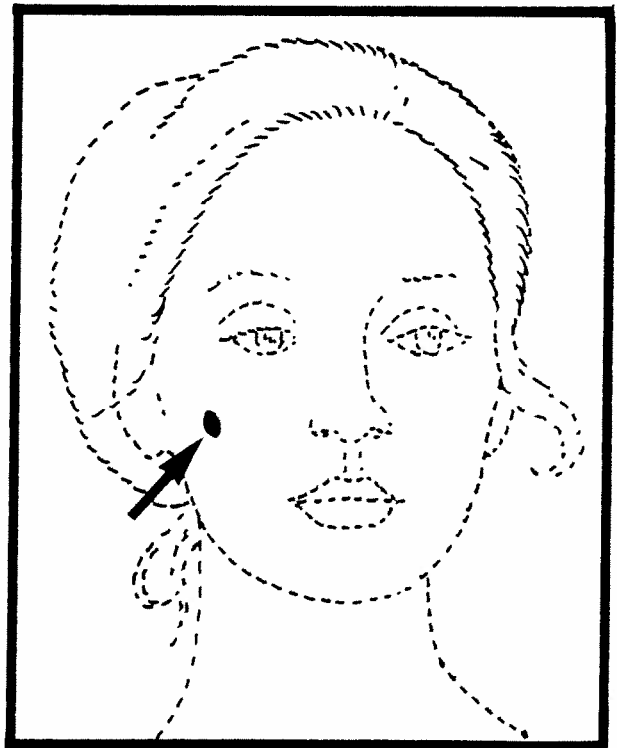

52

γ

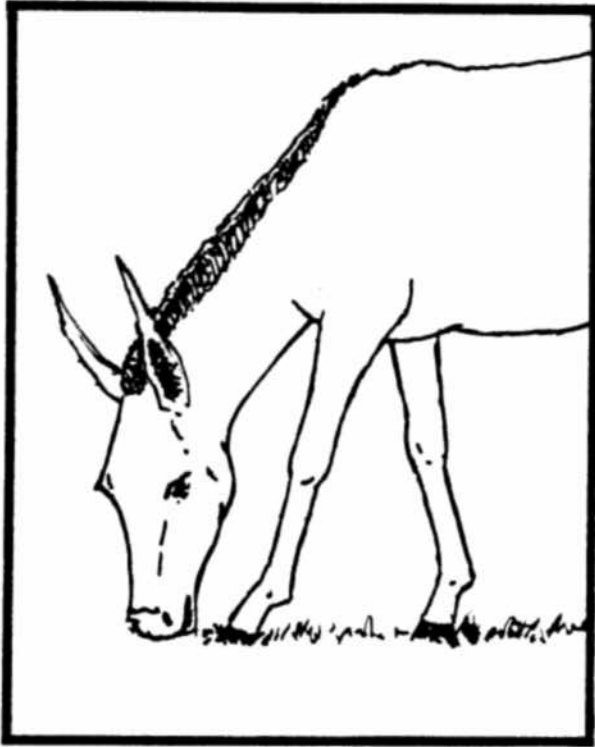

γ

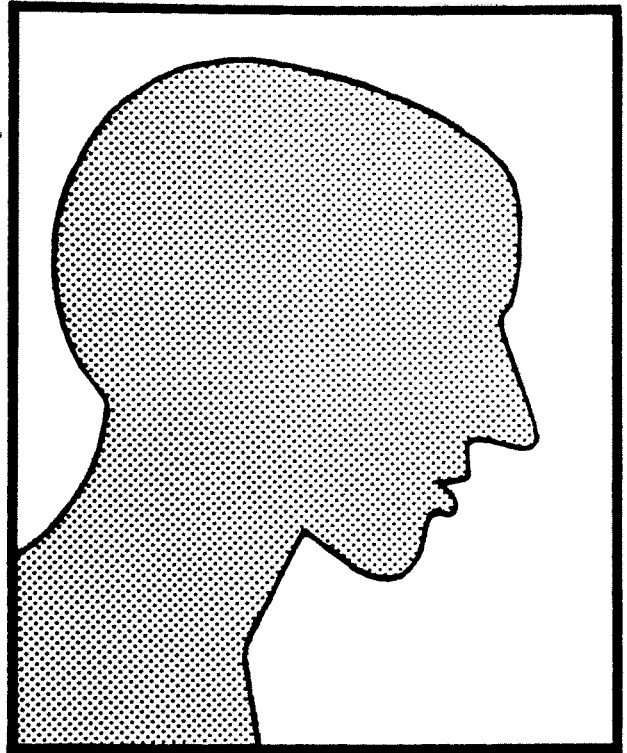

γ

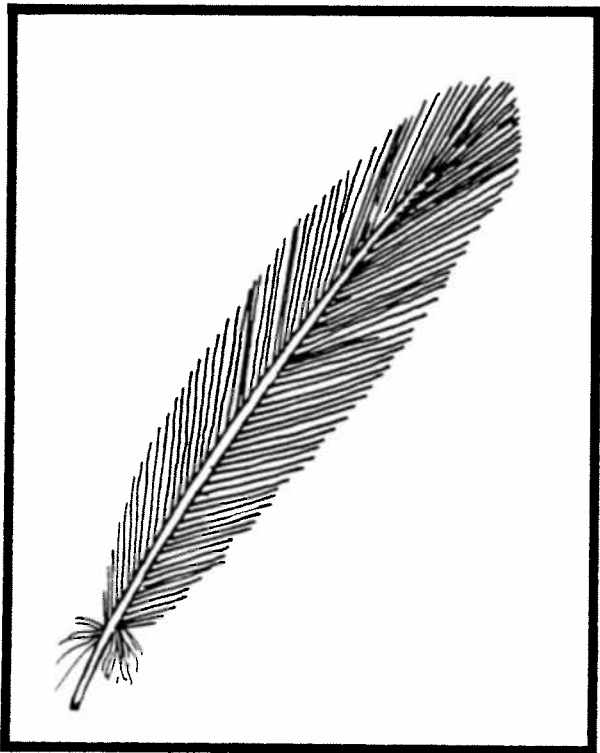

γ

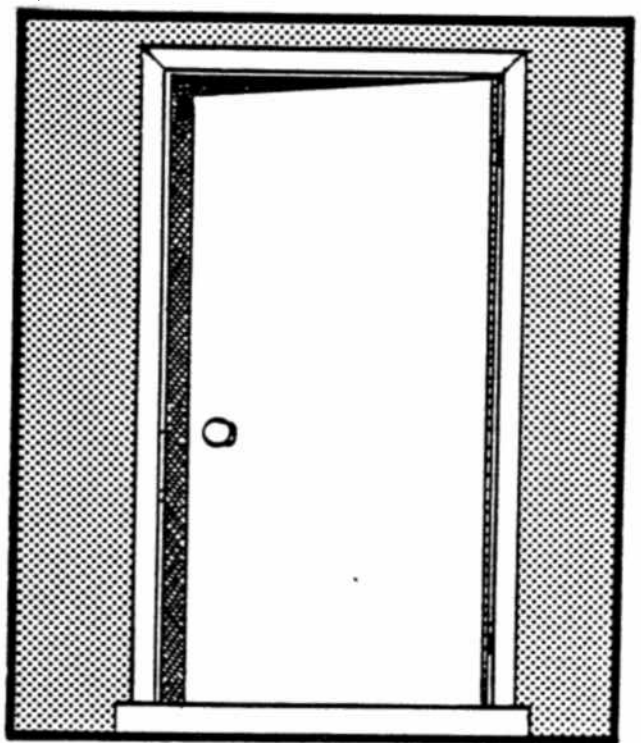

Δγ

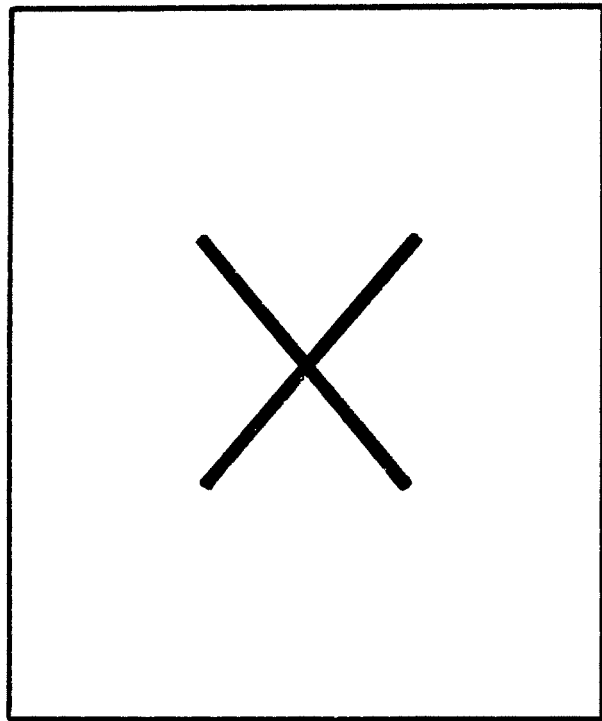

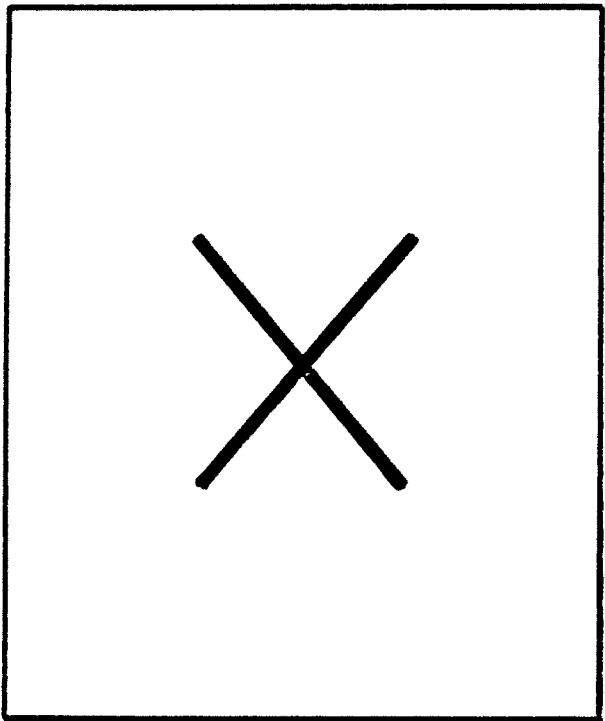

2

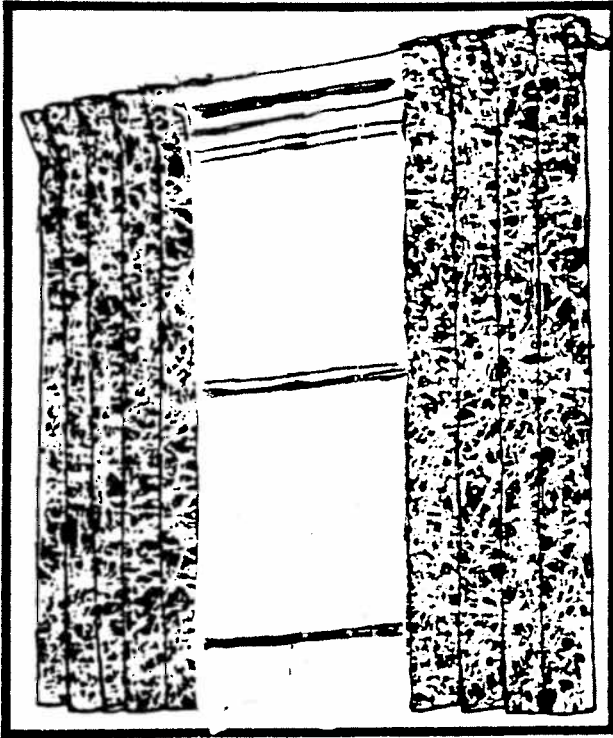

1

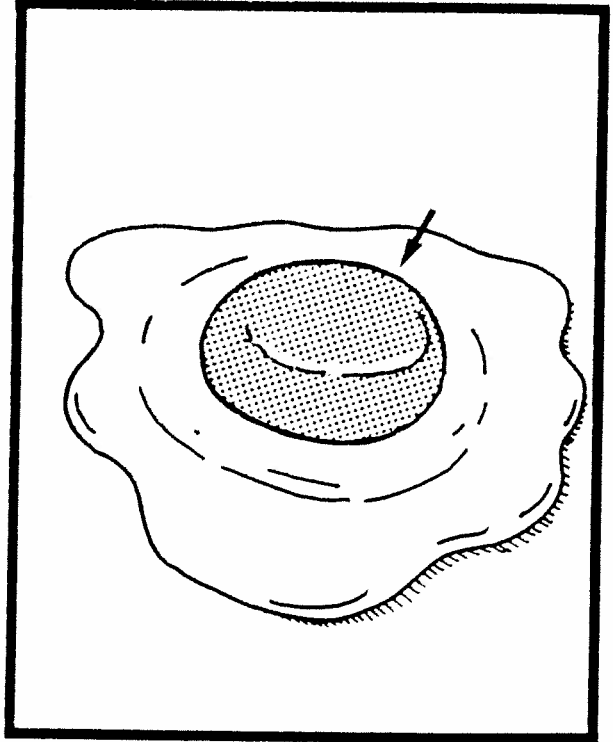

F



2

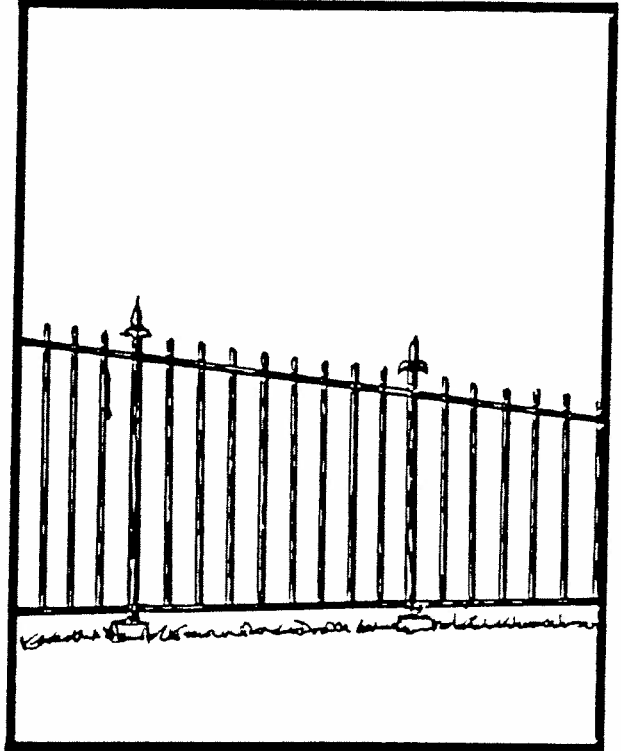

2

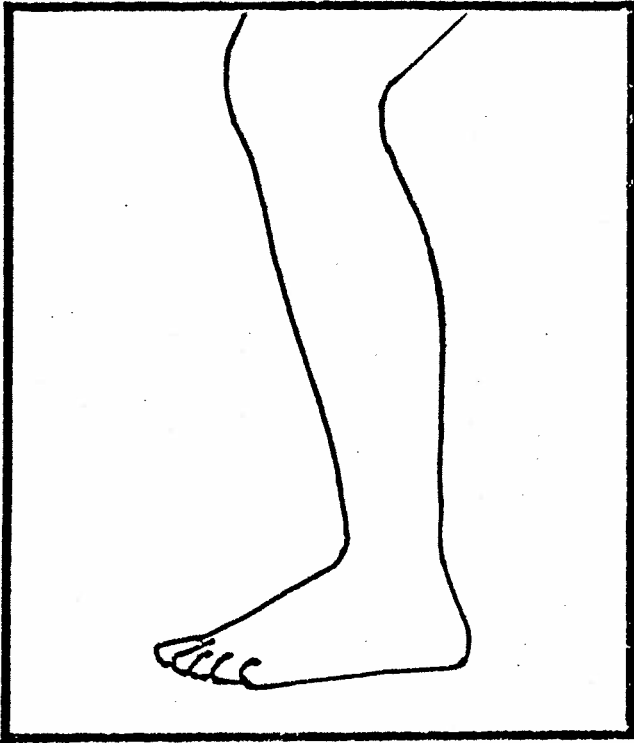

1

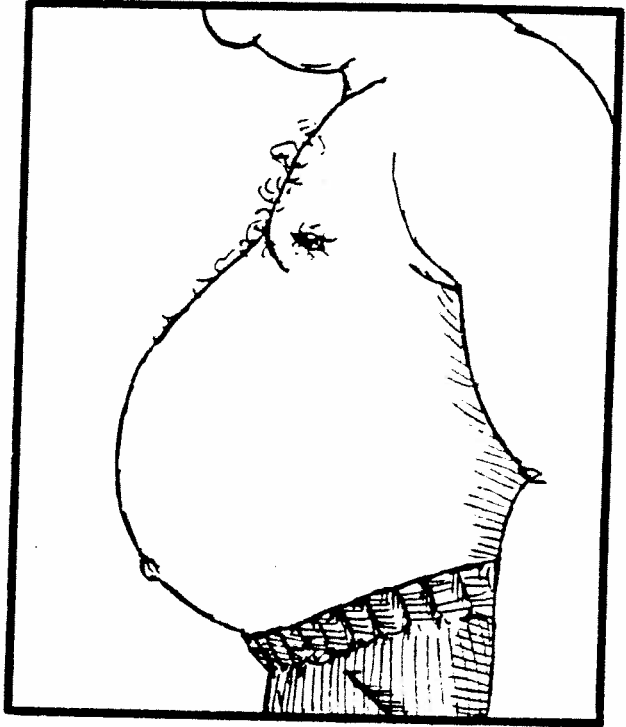

4

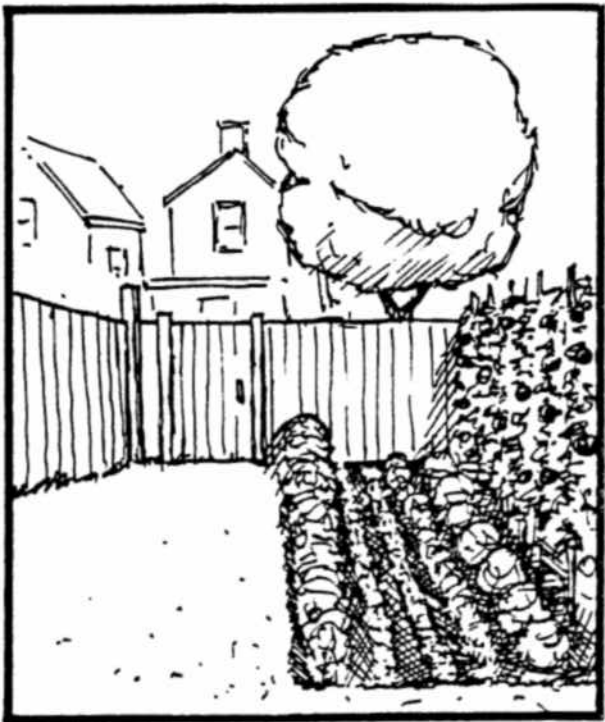

2

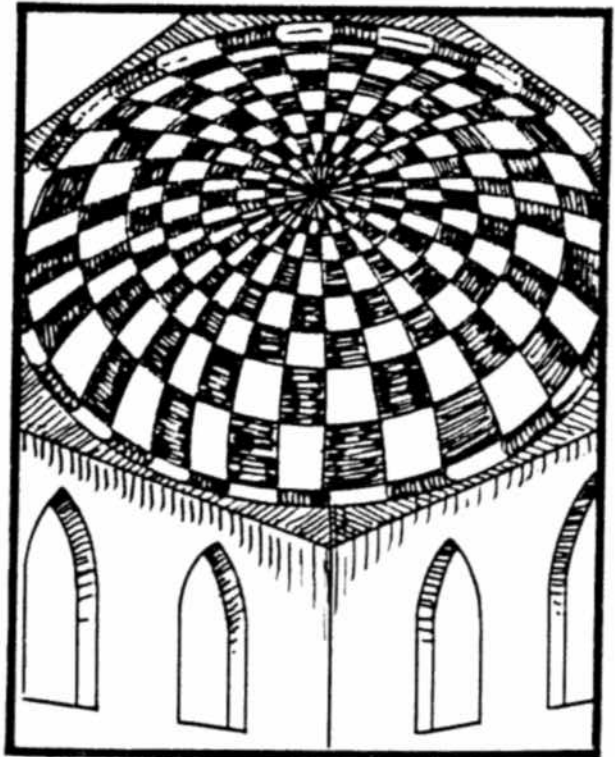

56

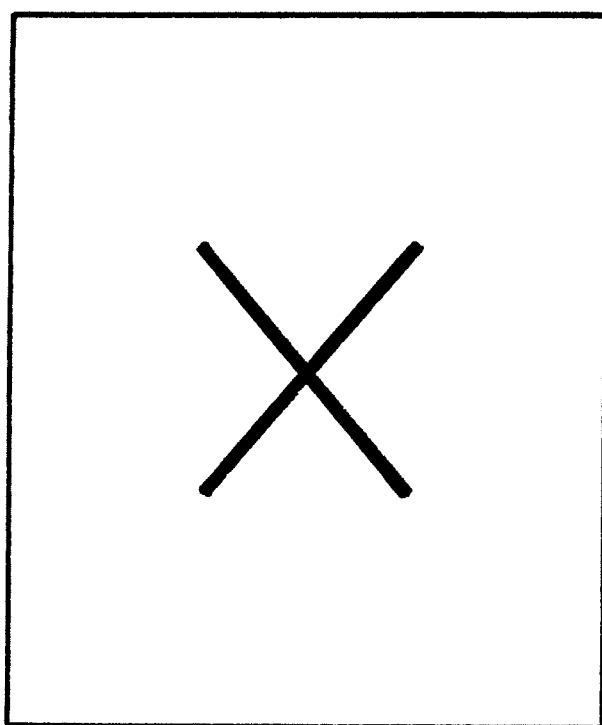

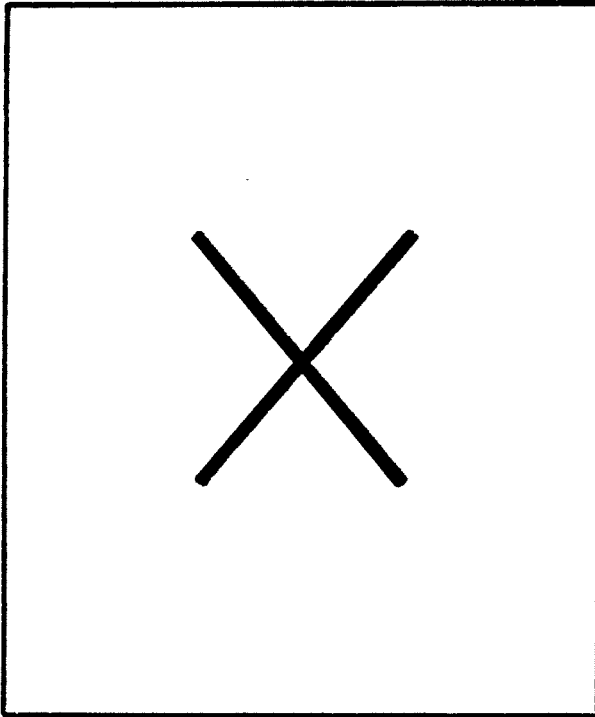

2

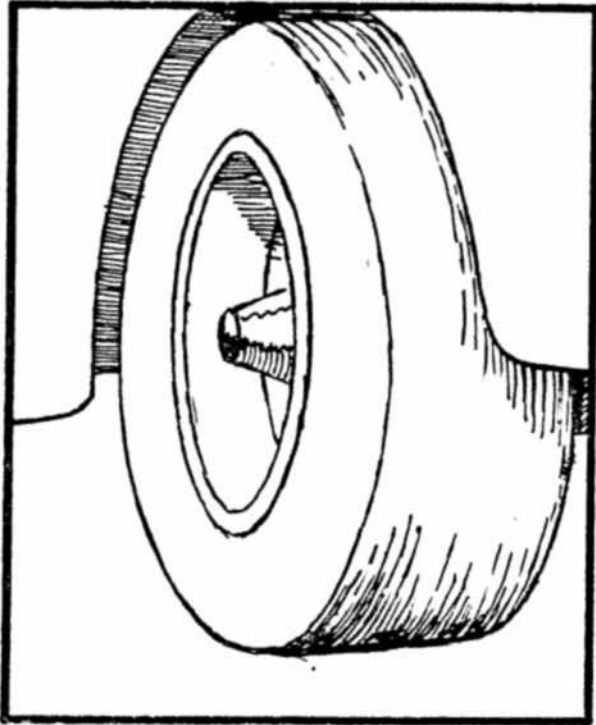

1

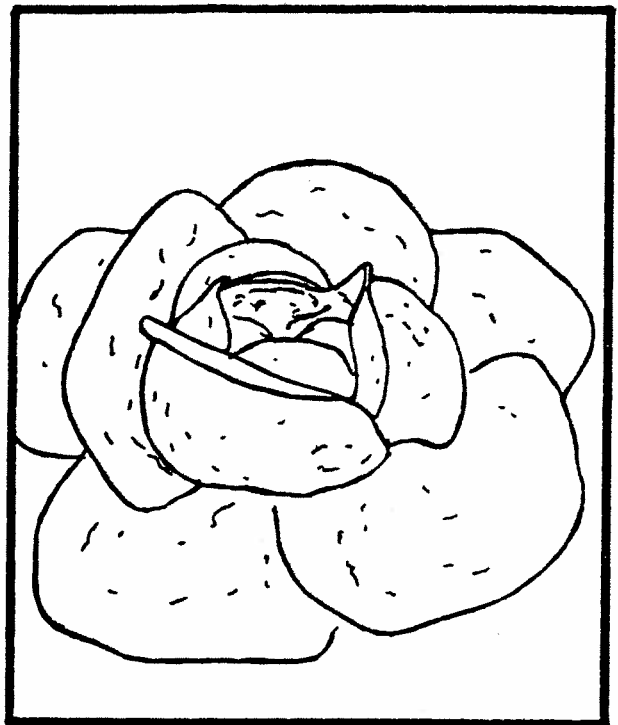

2



2

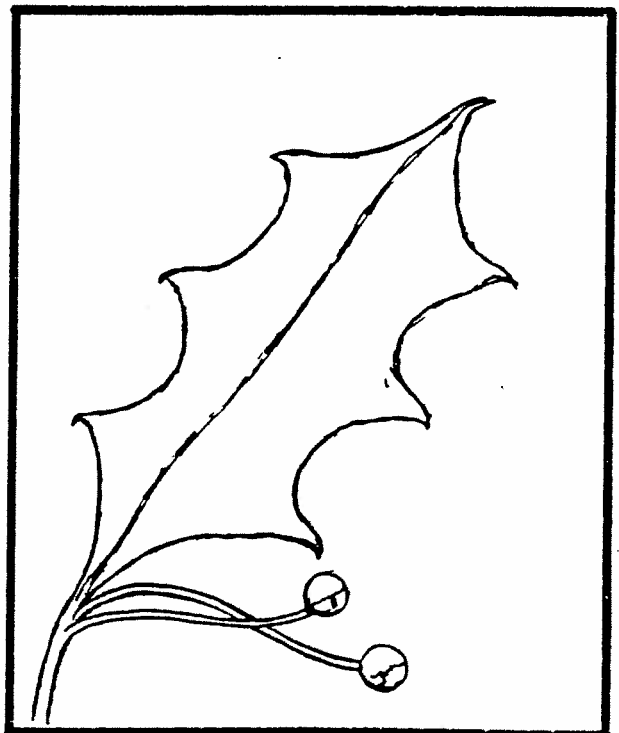

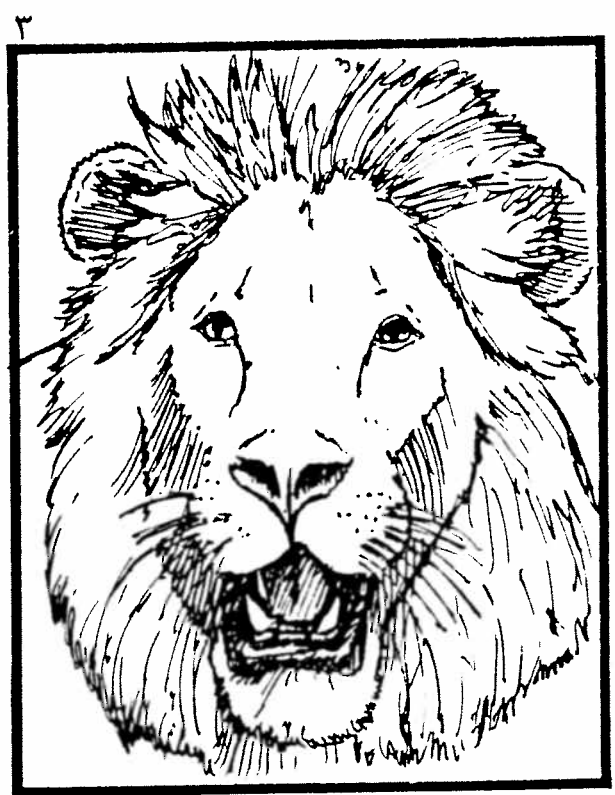
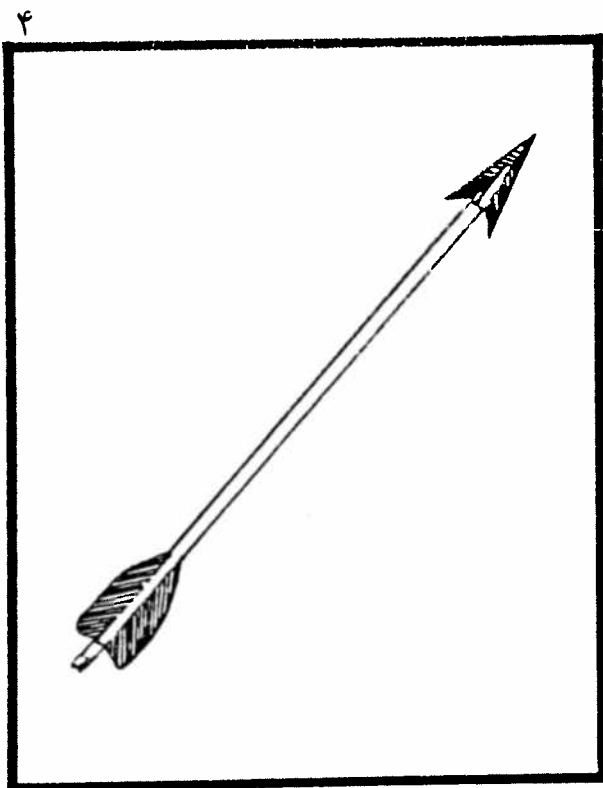
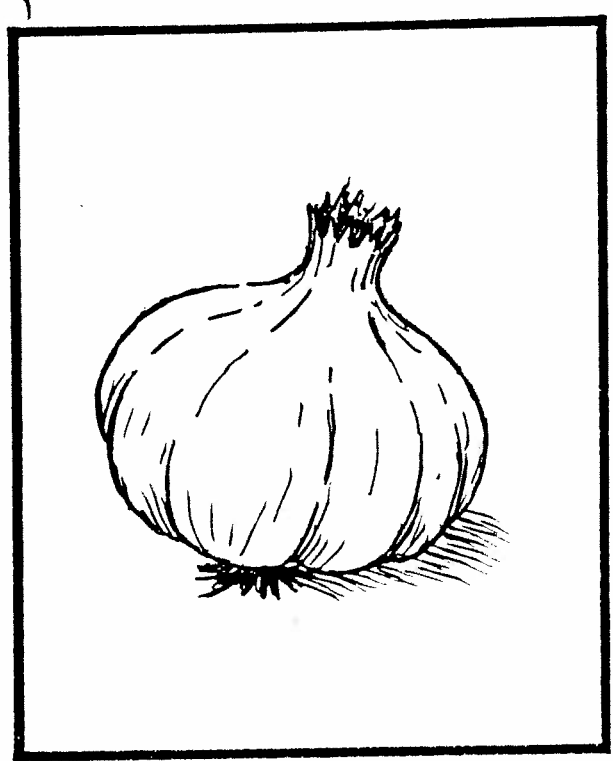
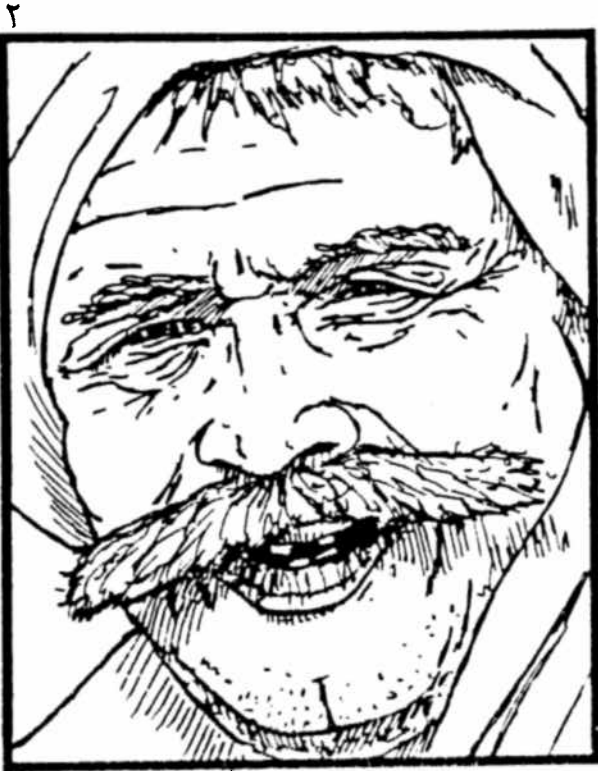

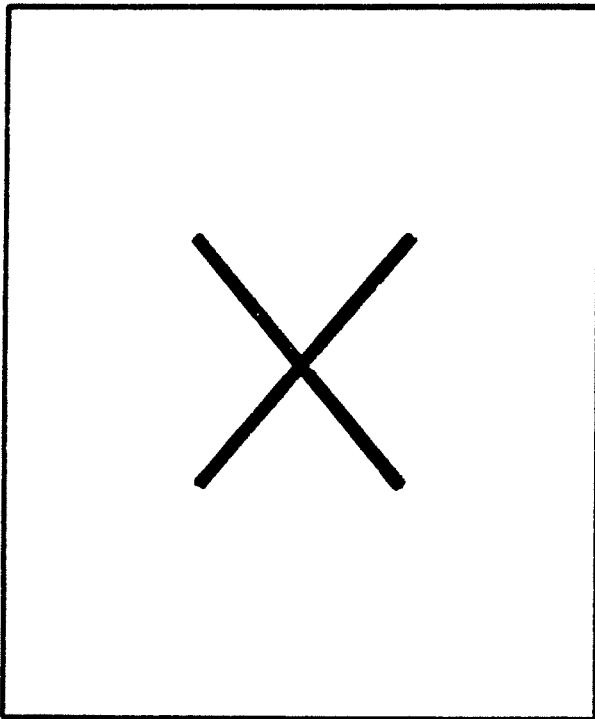

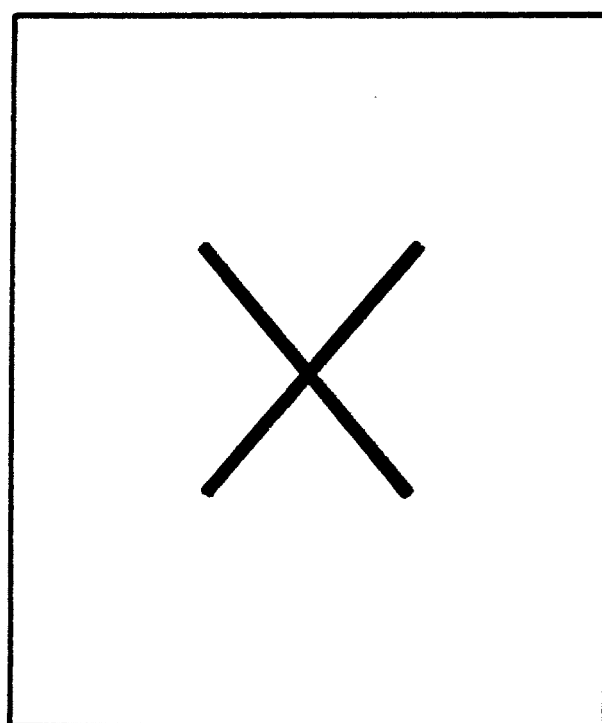

2



1

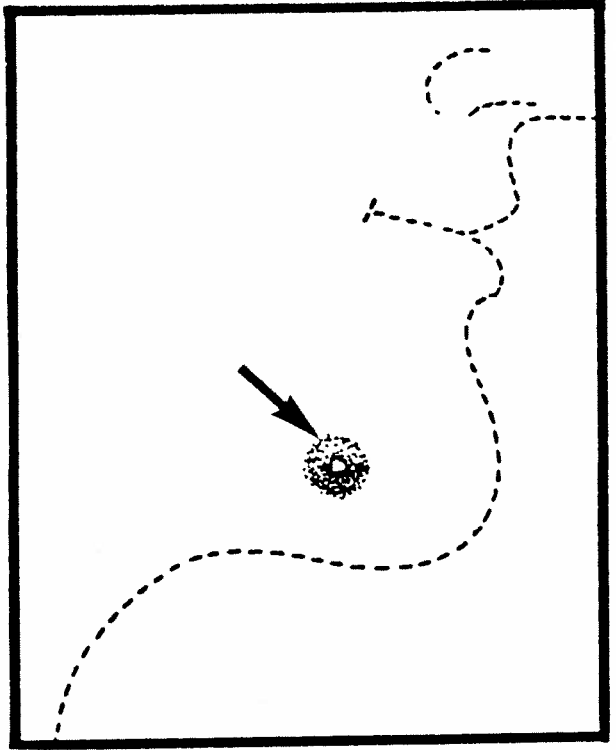

4

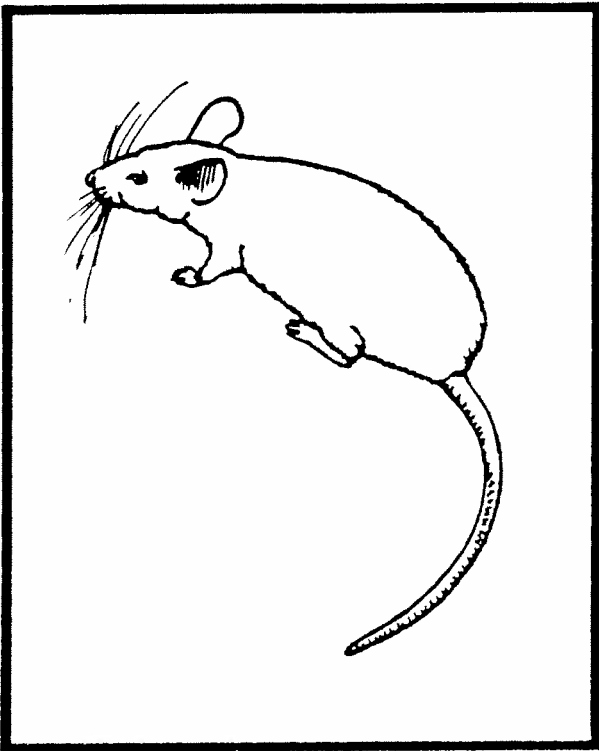

3

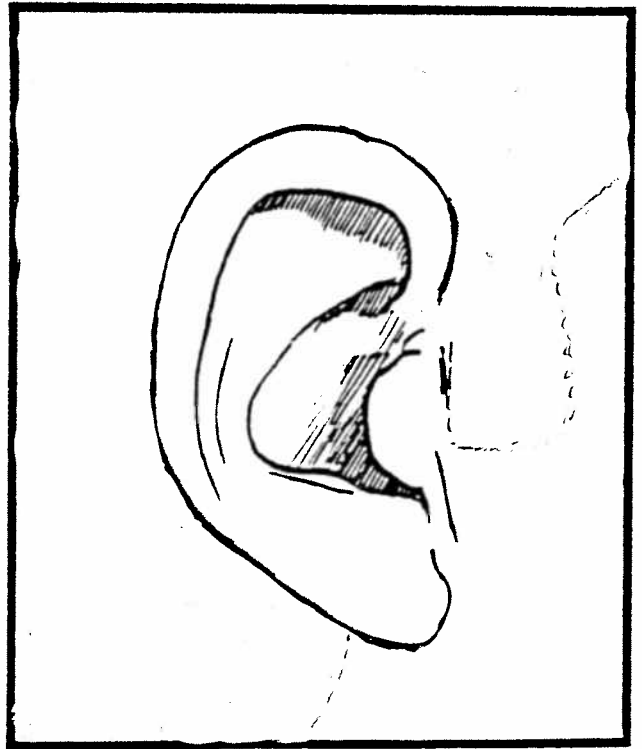

2

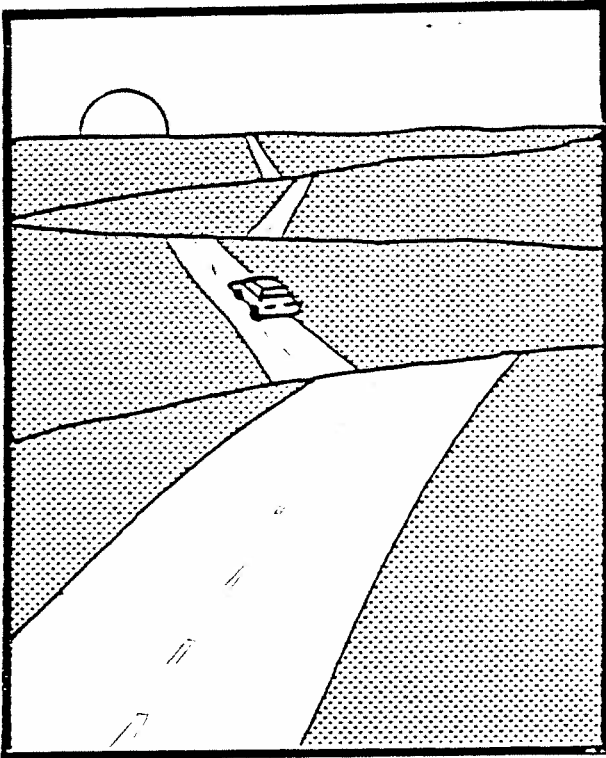

1



4

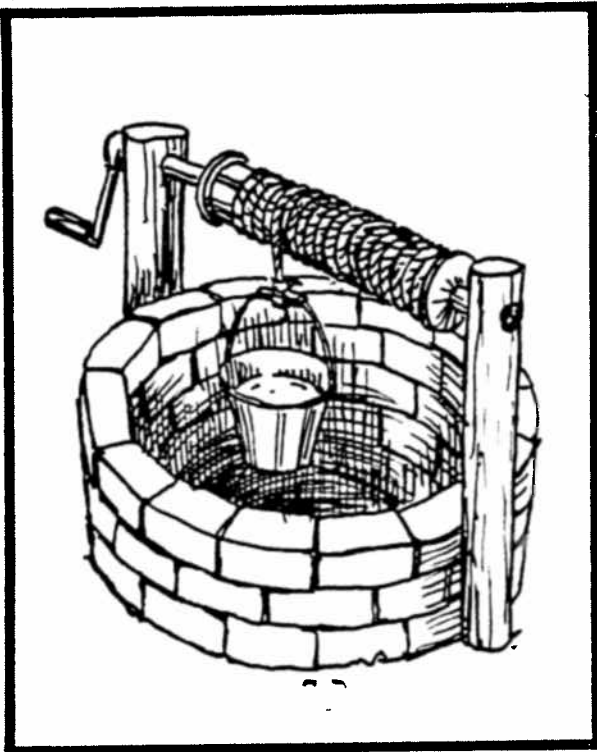

2

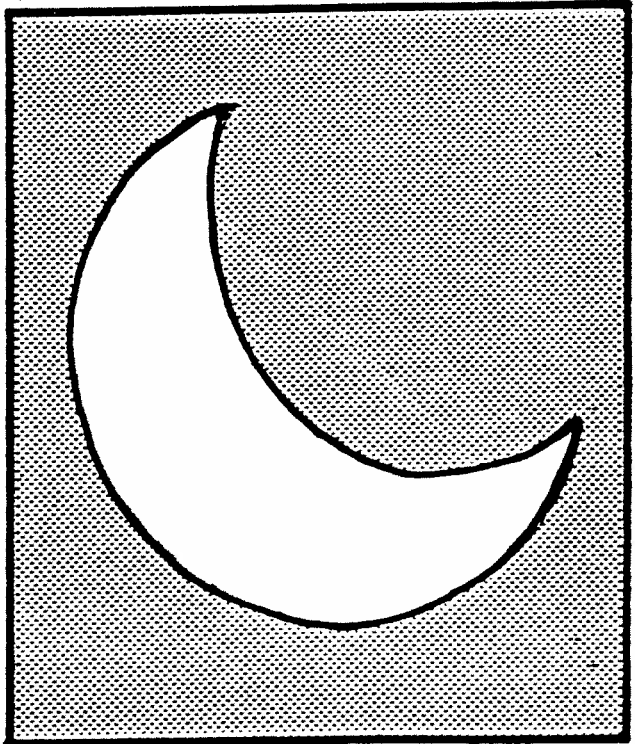

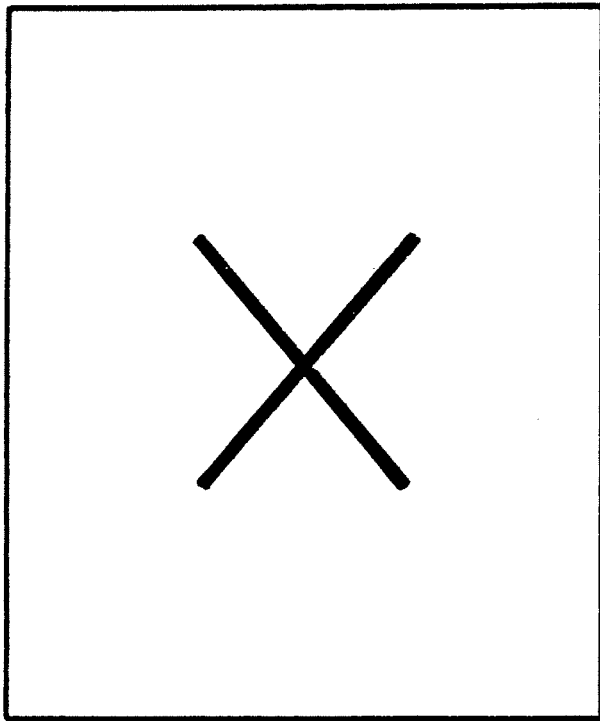

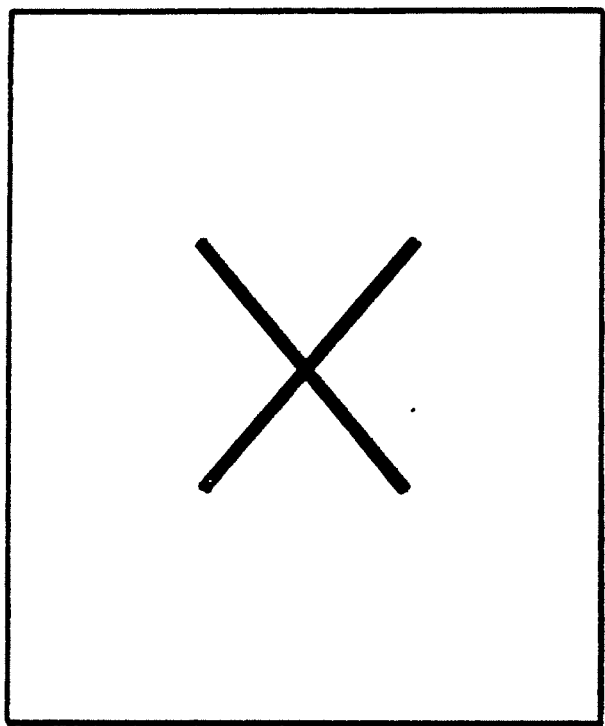

۲

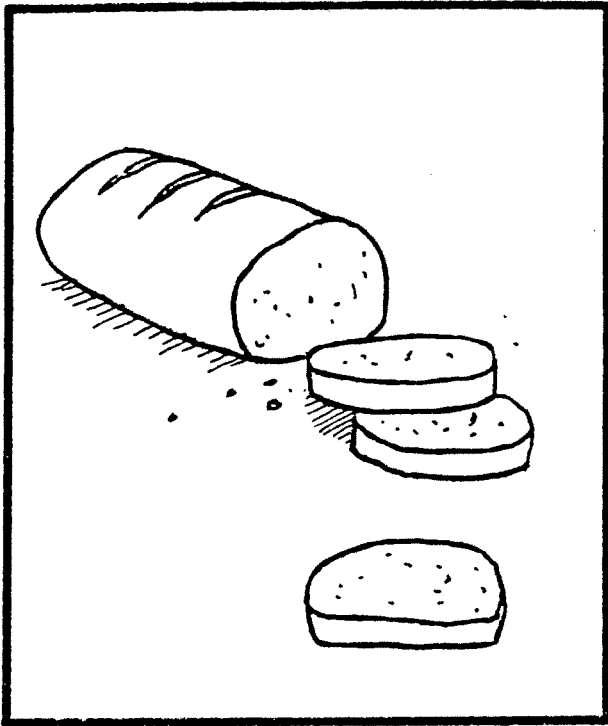

۱

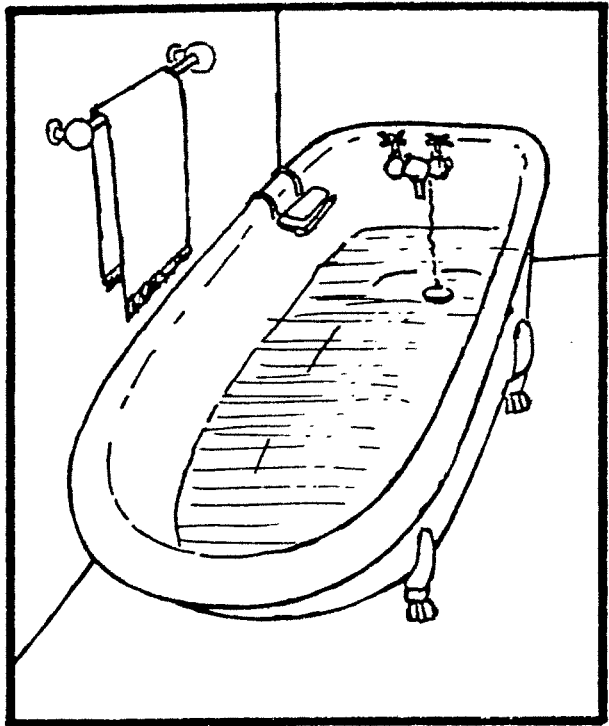

۶

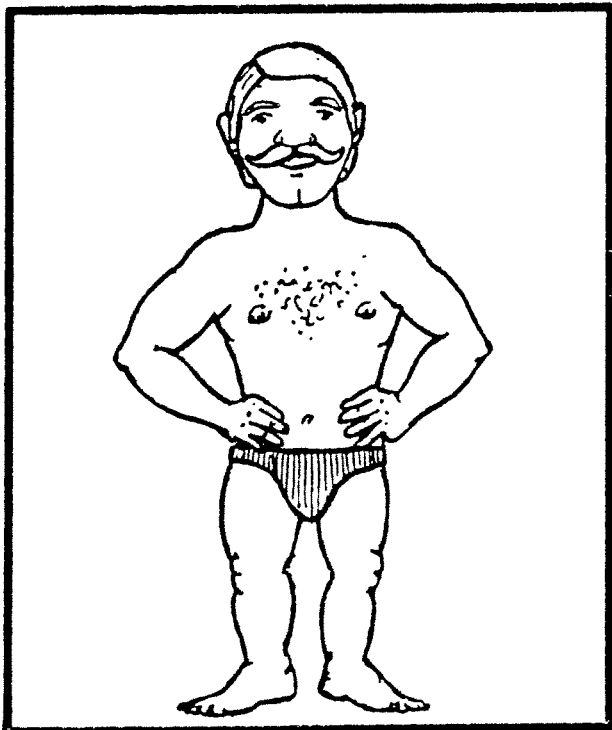

۲

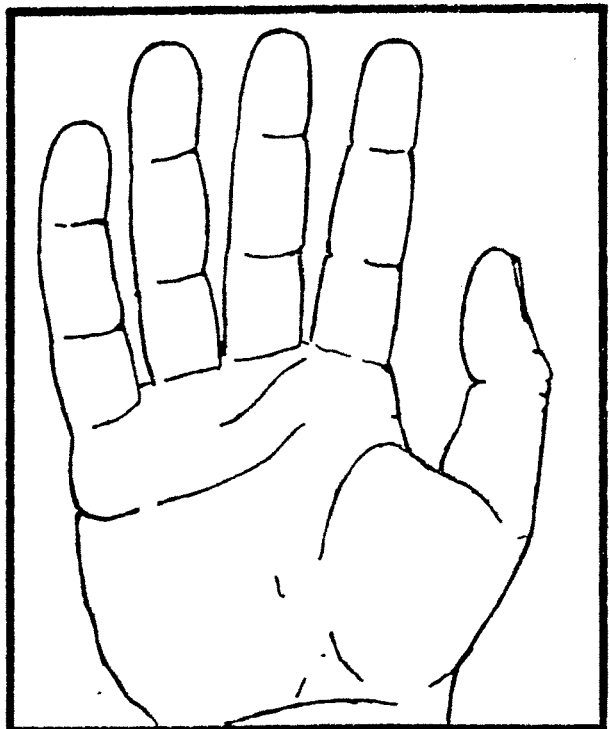

۲

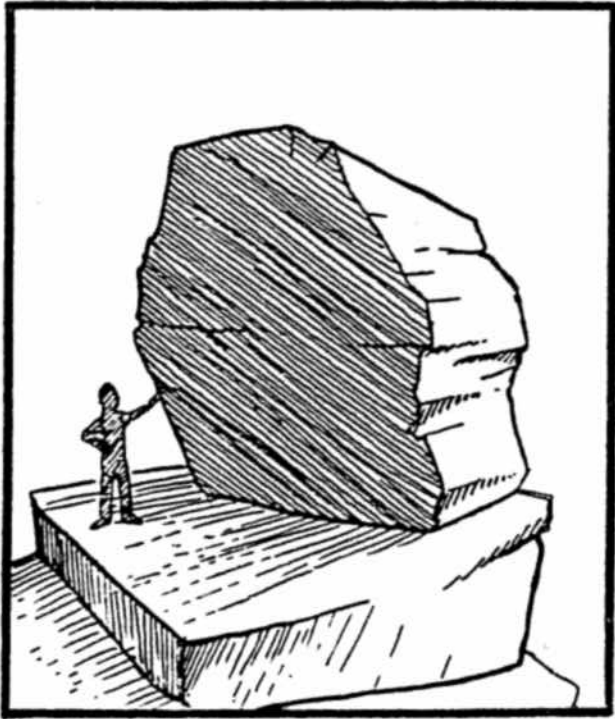

۱

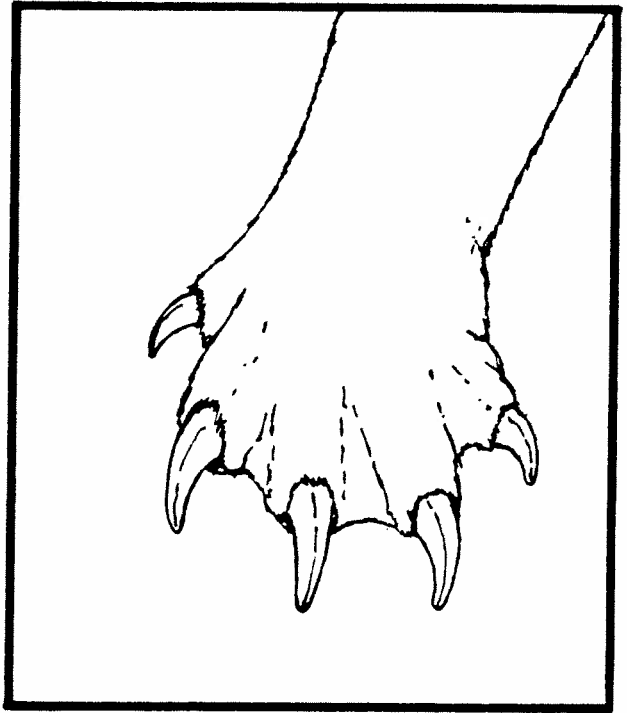

۶

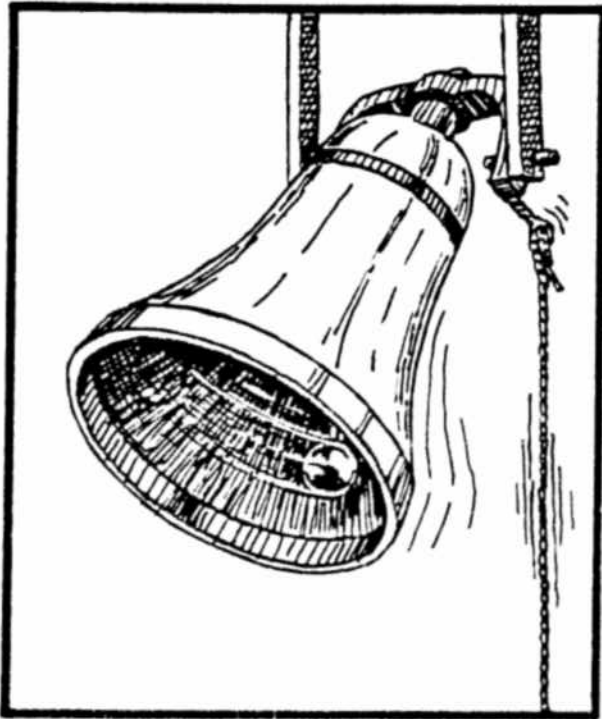

۲

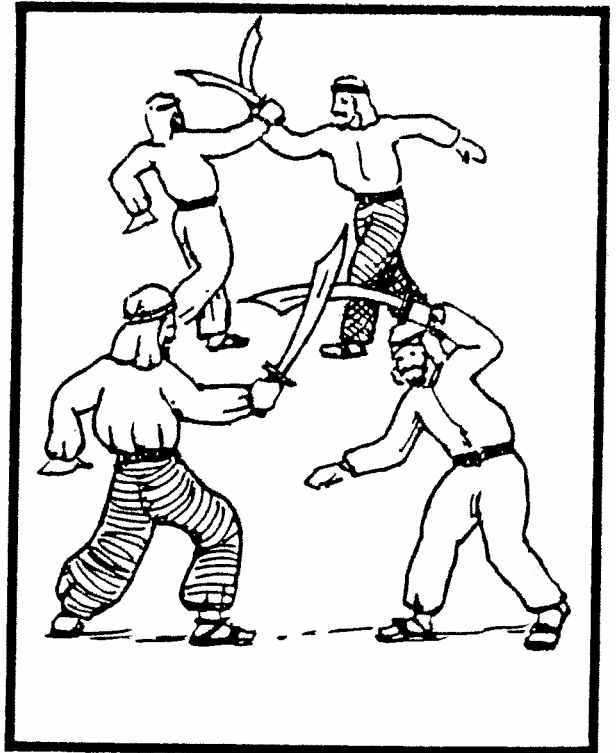

۶۲

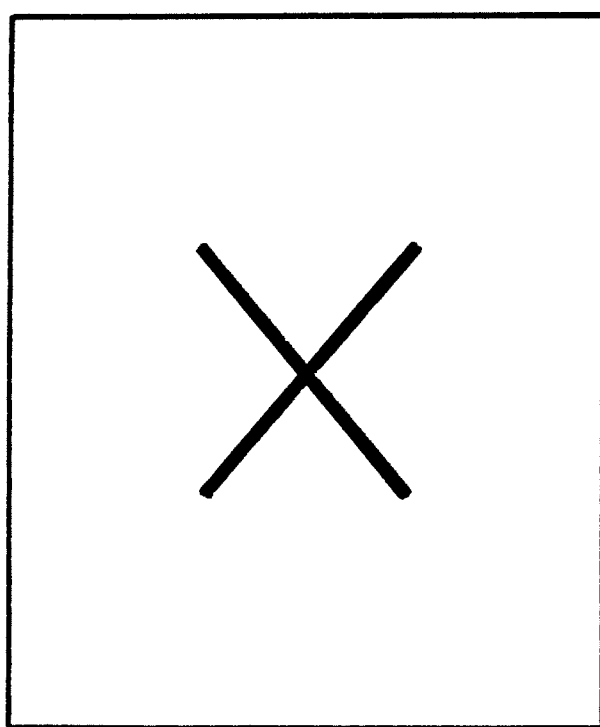

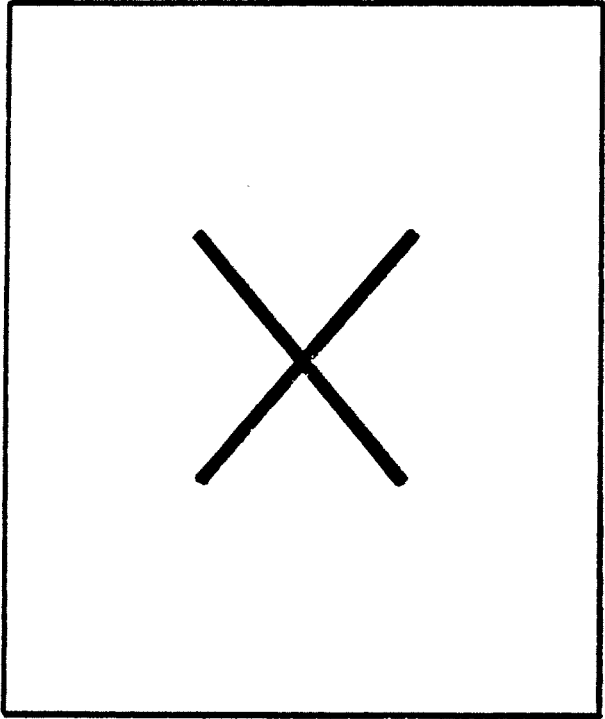

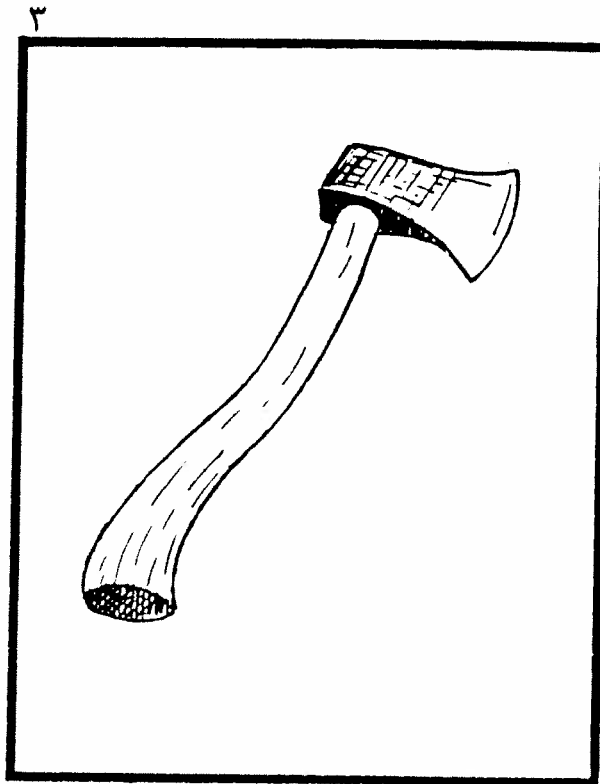
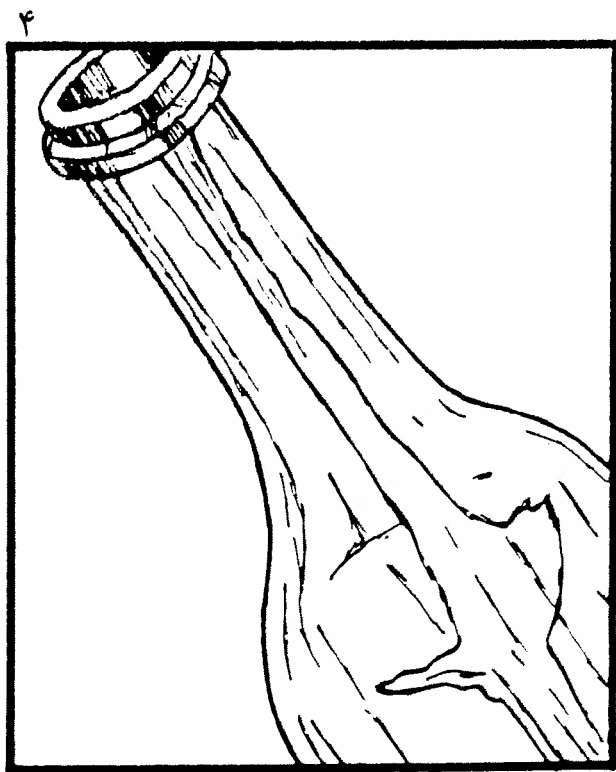
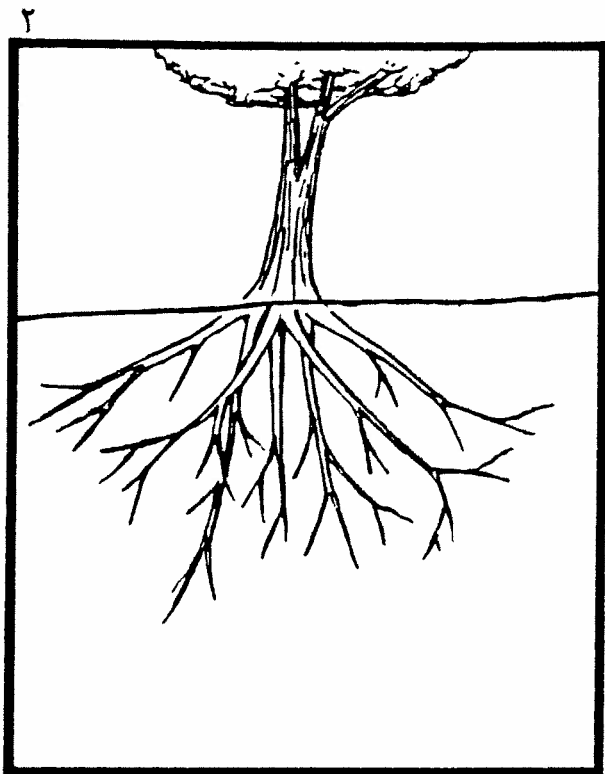

۲



۱

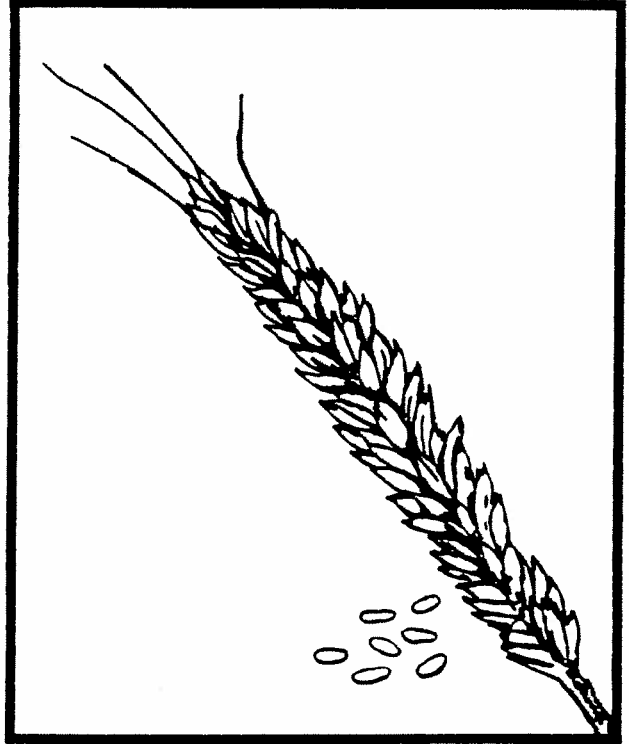

۴

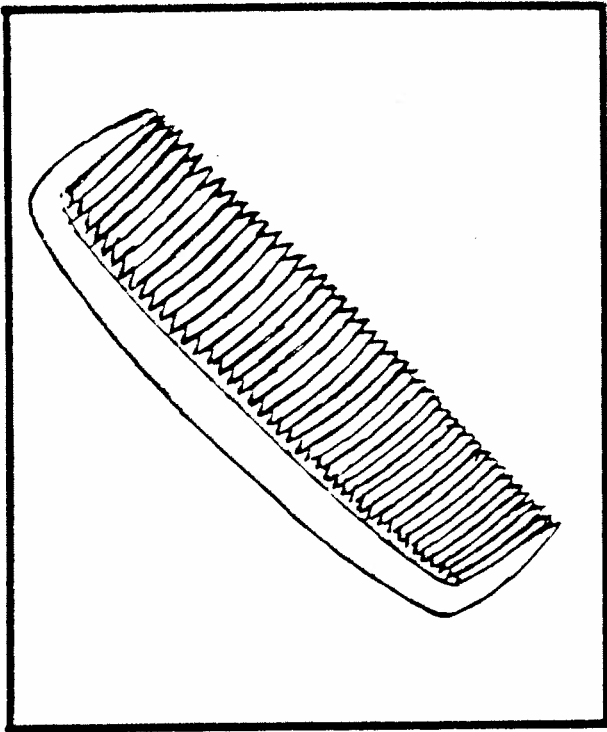

۳

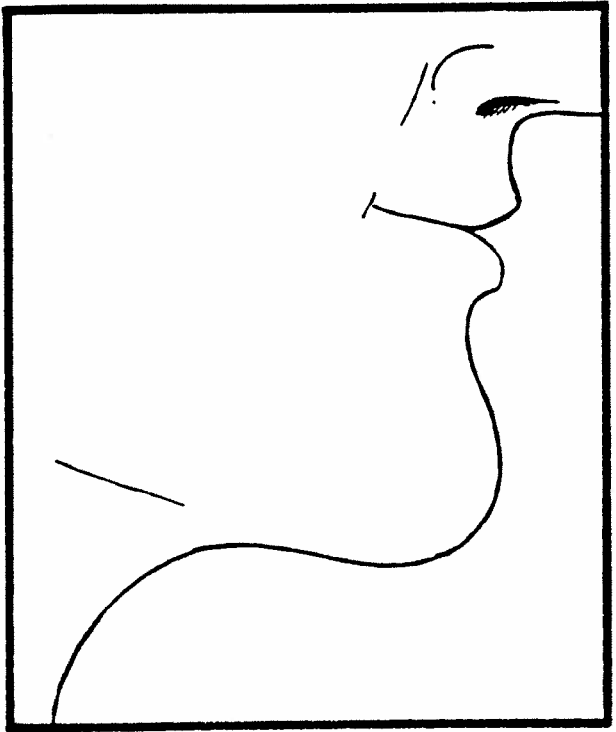

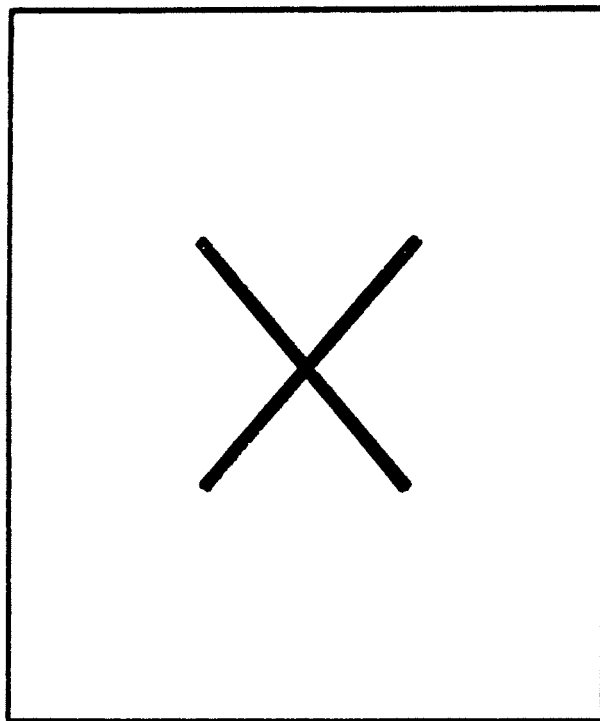

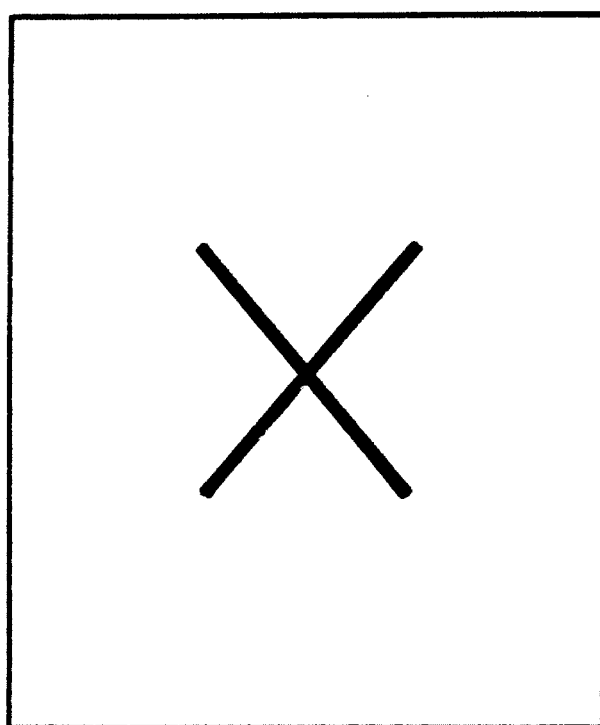

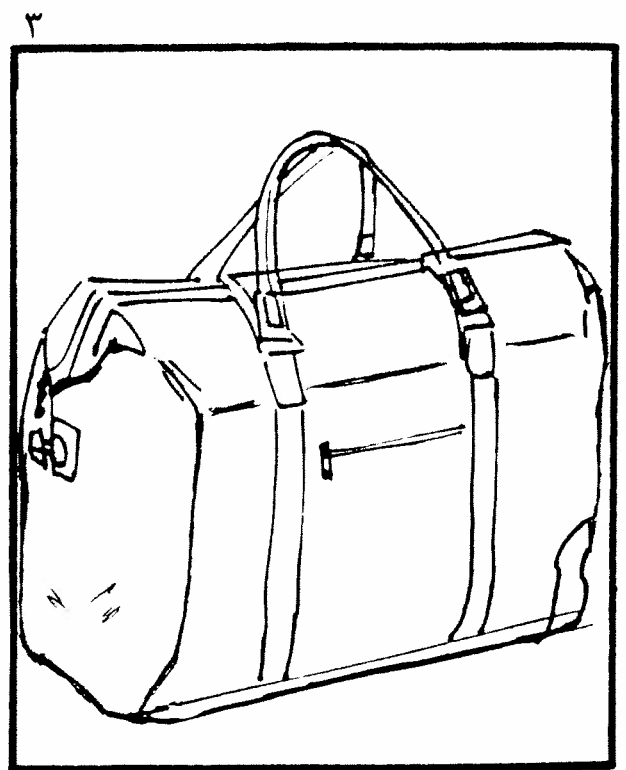
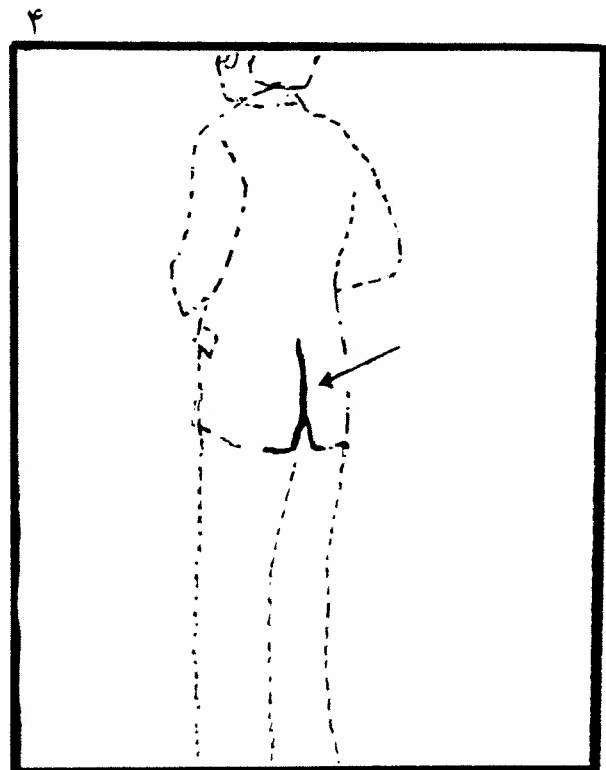
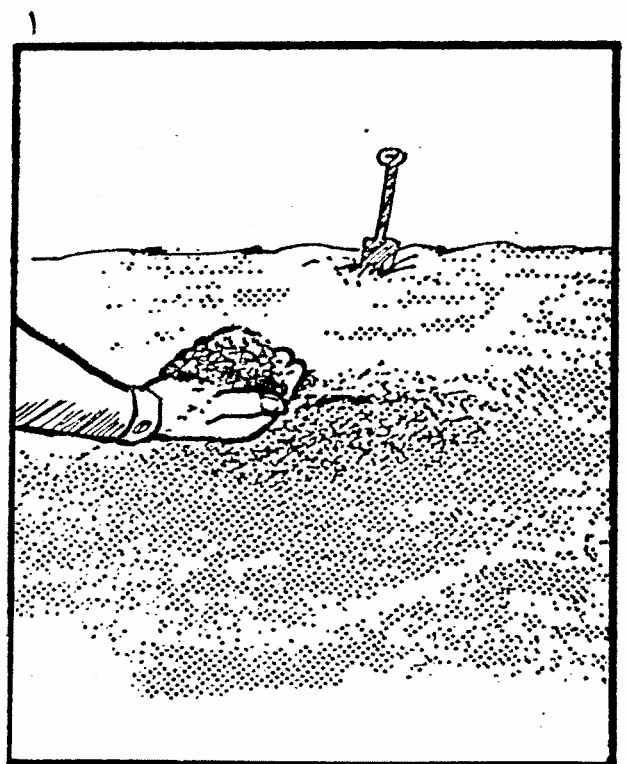

تصویرهای بخش درک نحوی

مثال

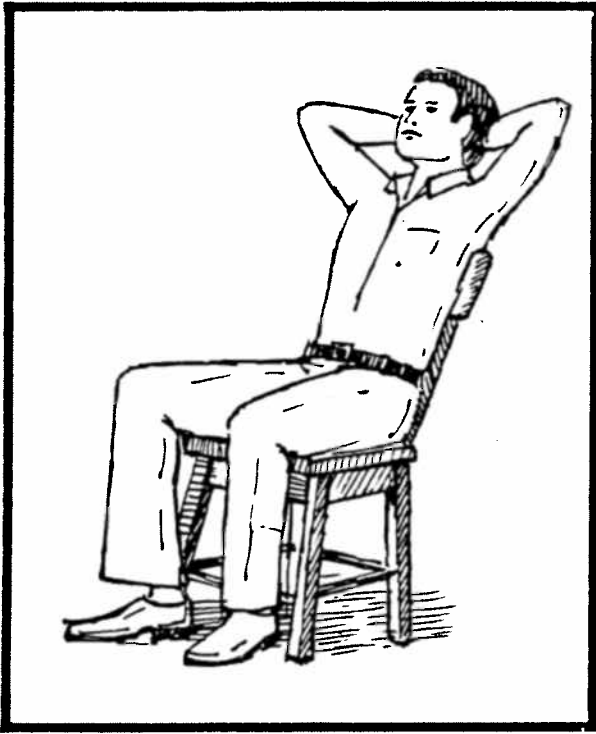

٢

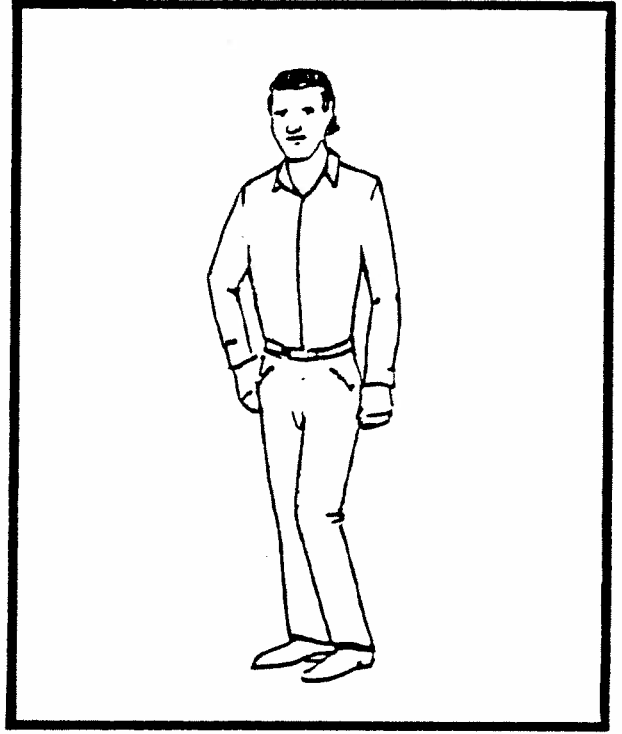

١

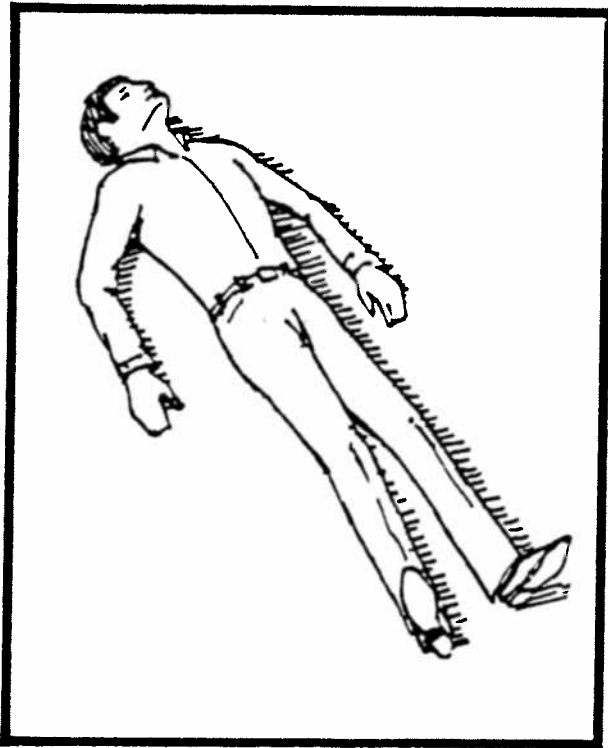

٤



٣

1

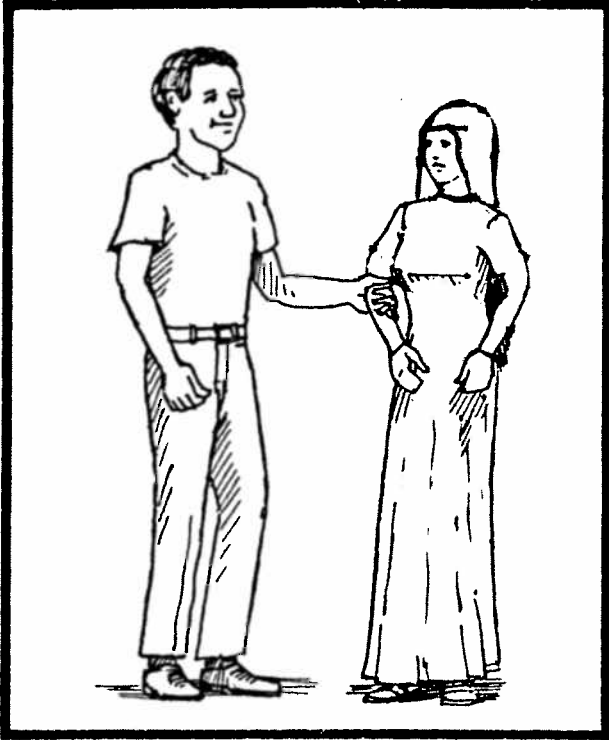

2

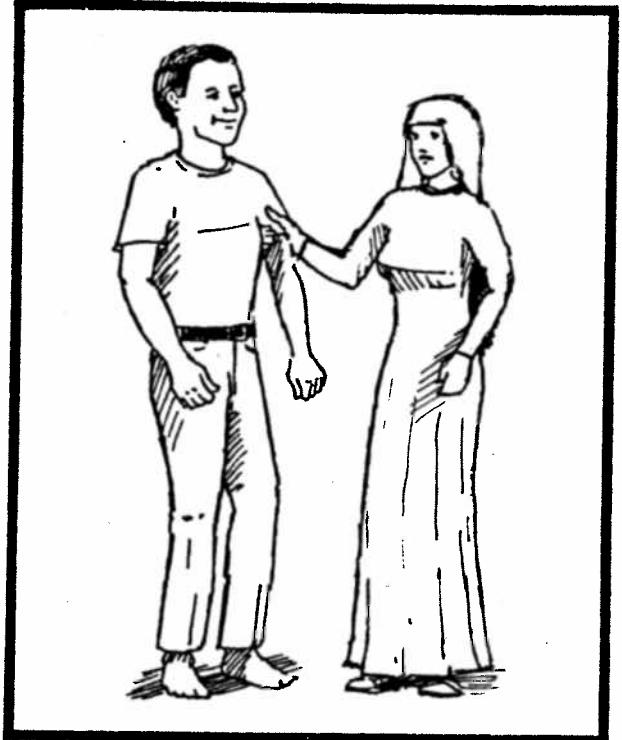

4



3

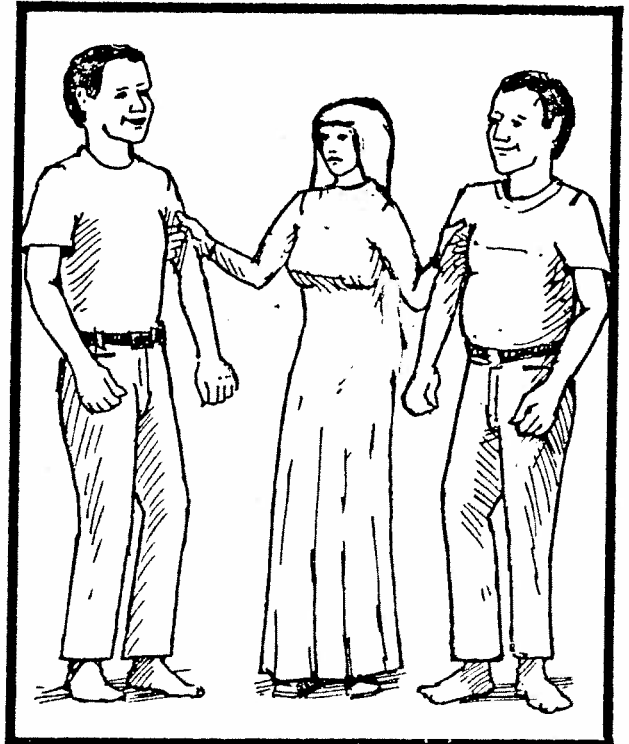

1

2



1



4



2



2



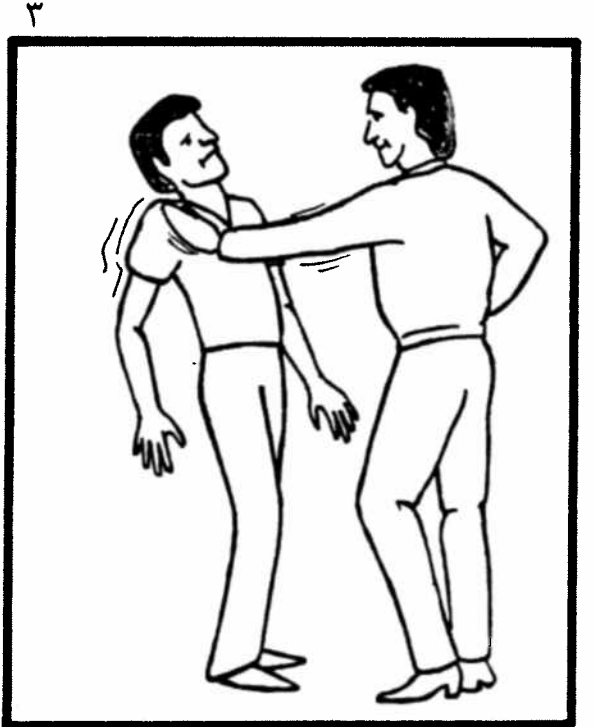
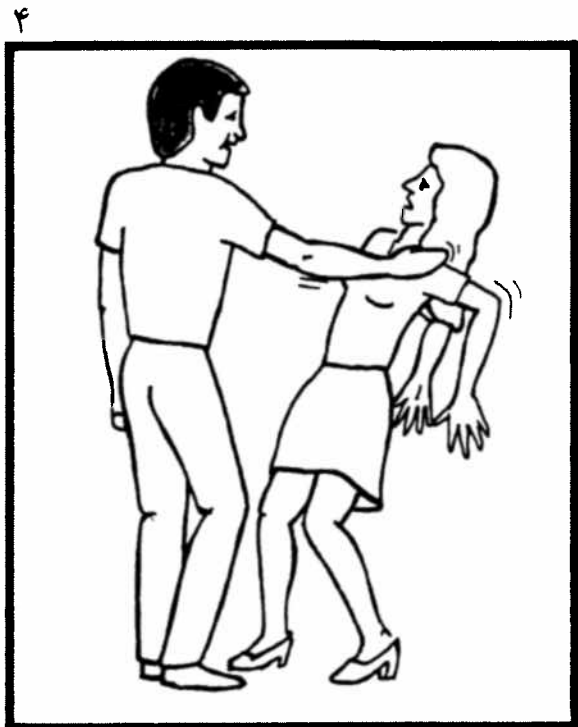
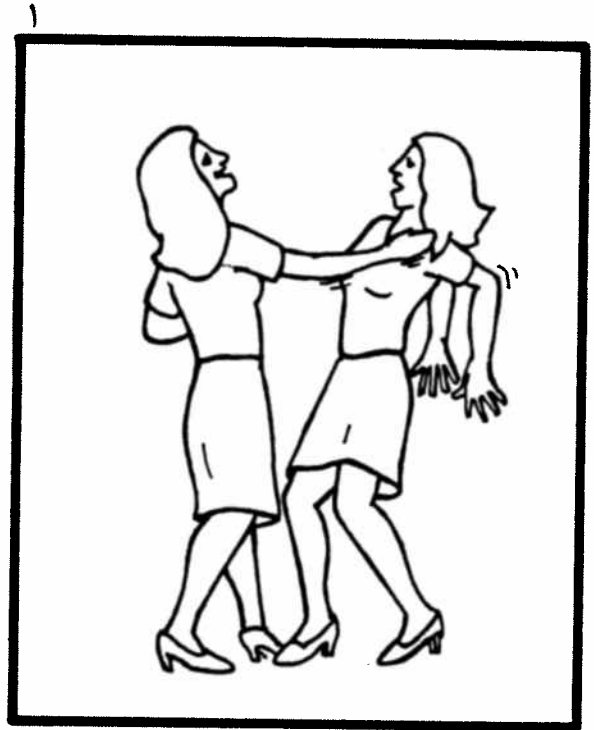
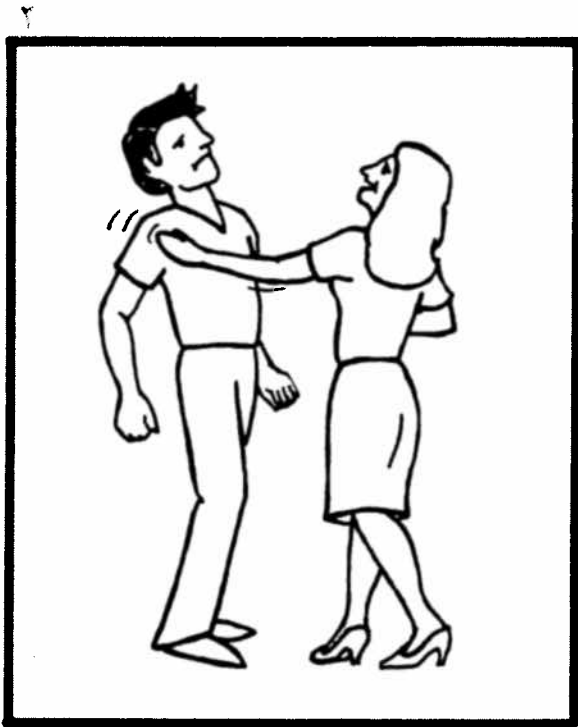

1

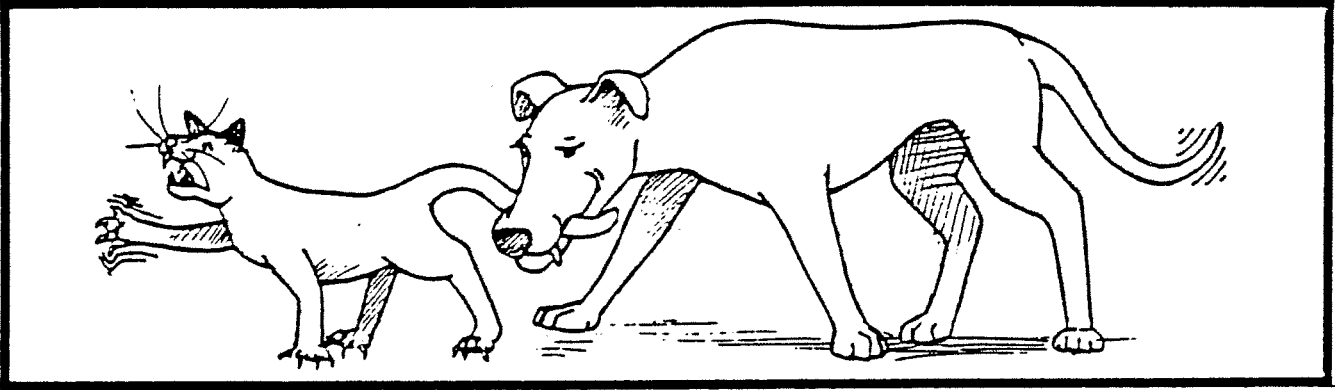

2

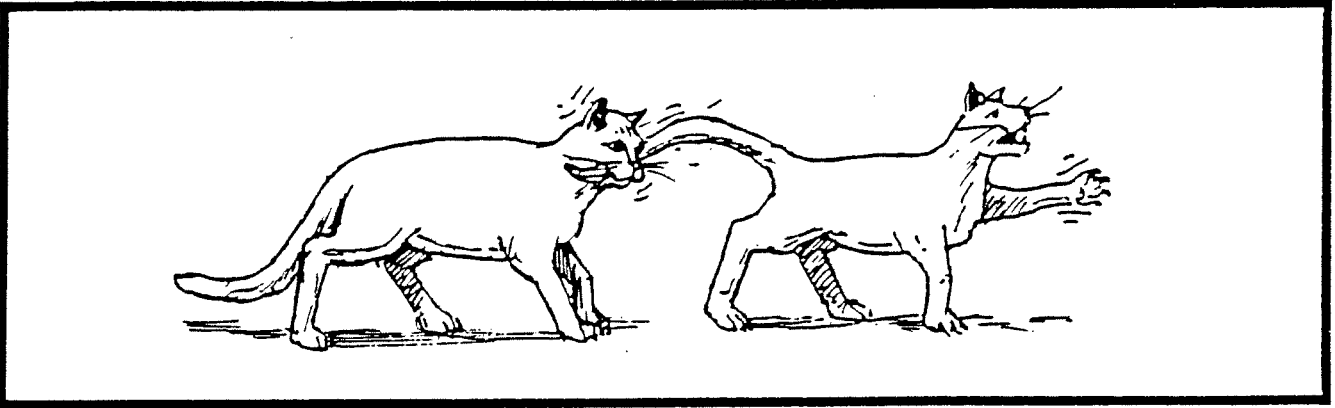

3

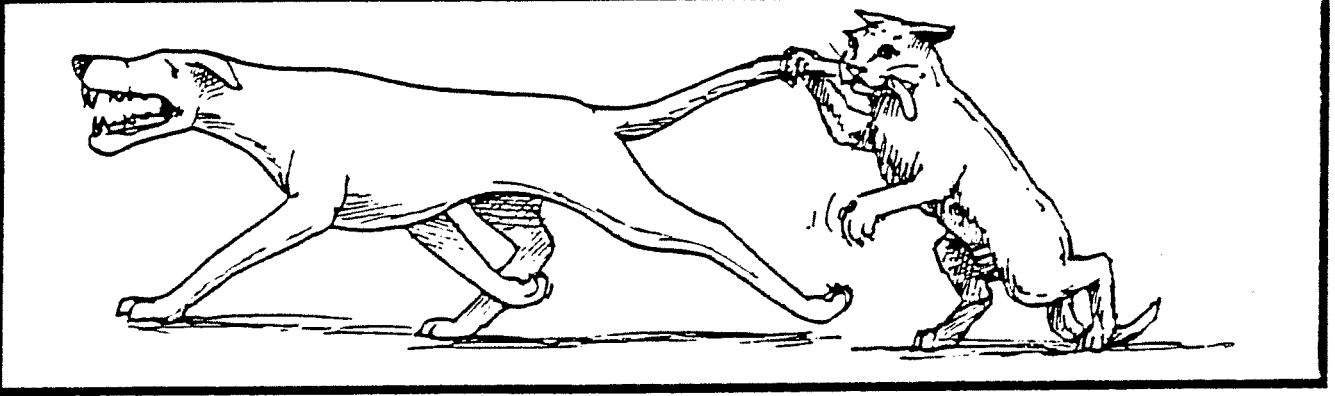

4

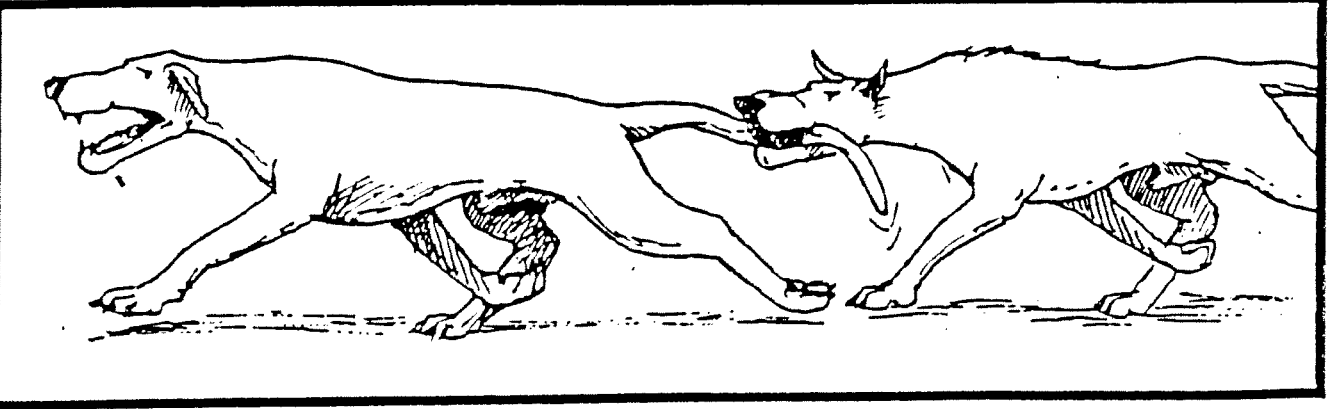

5

1

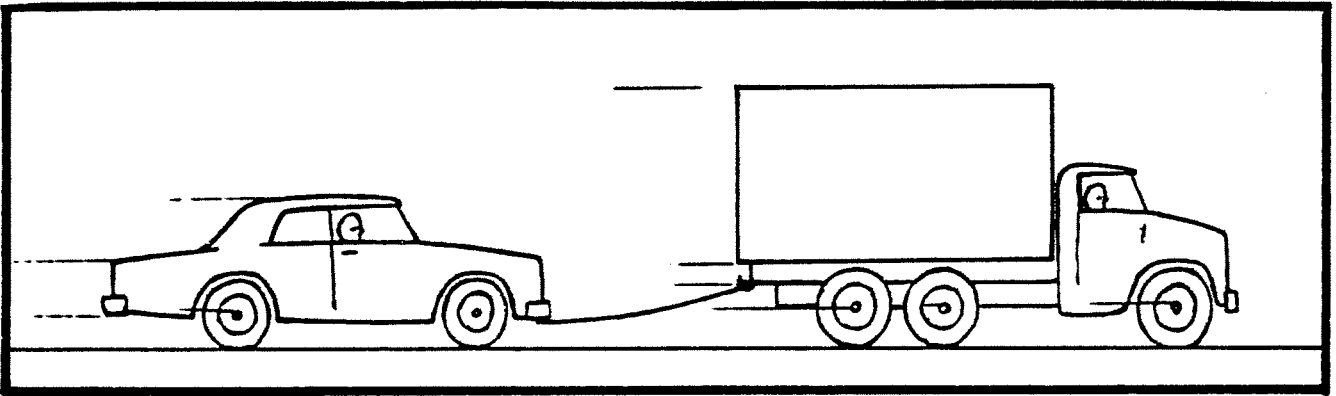

2

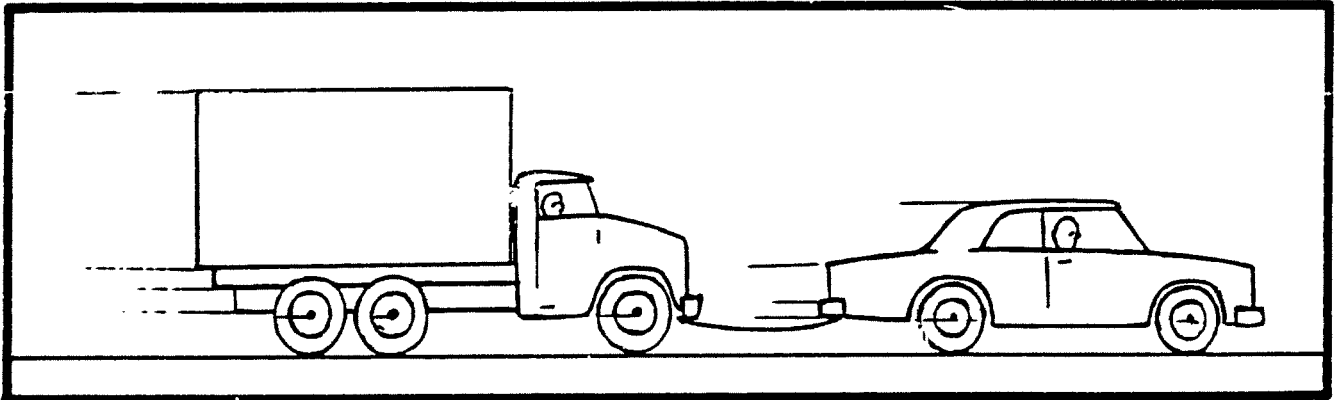

3

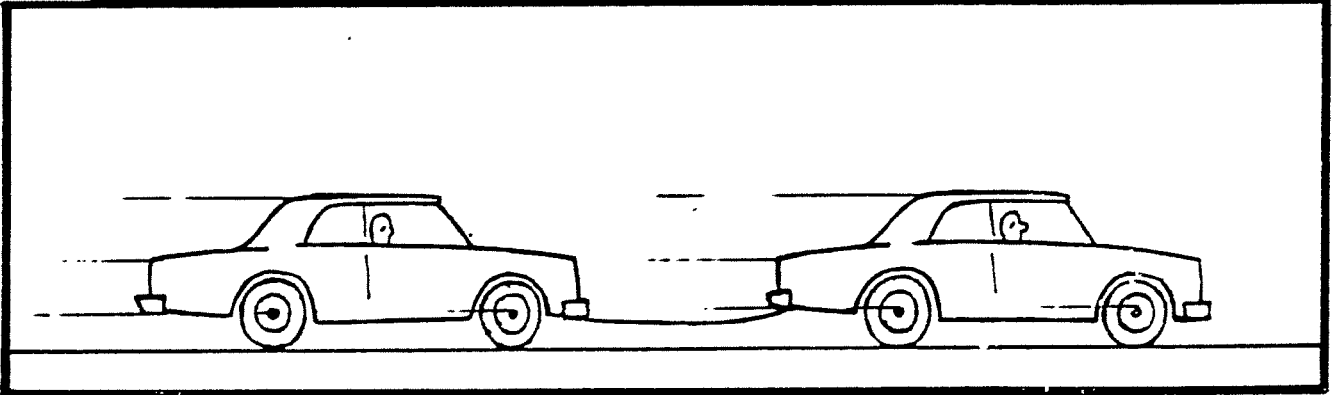

4

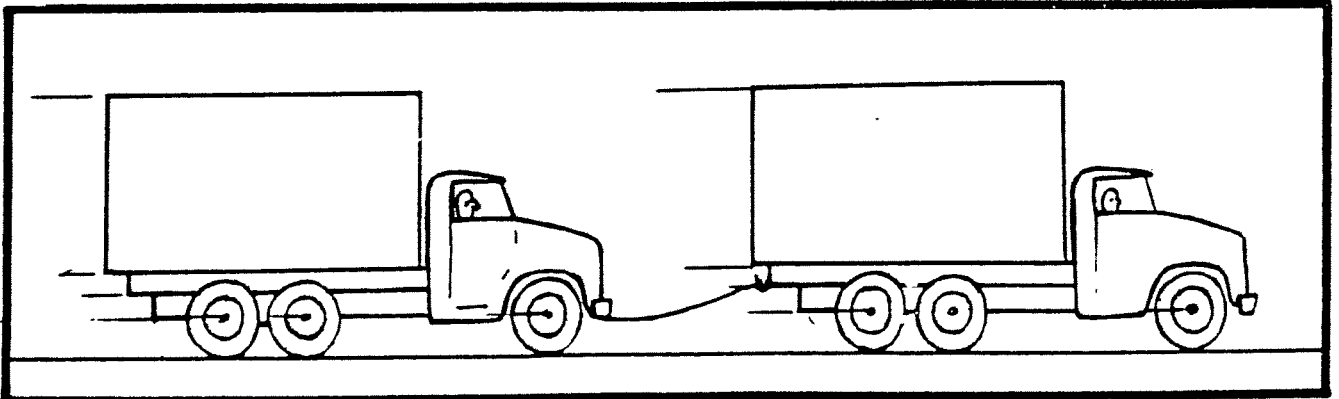

6

Y



1

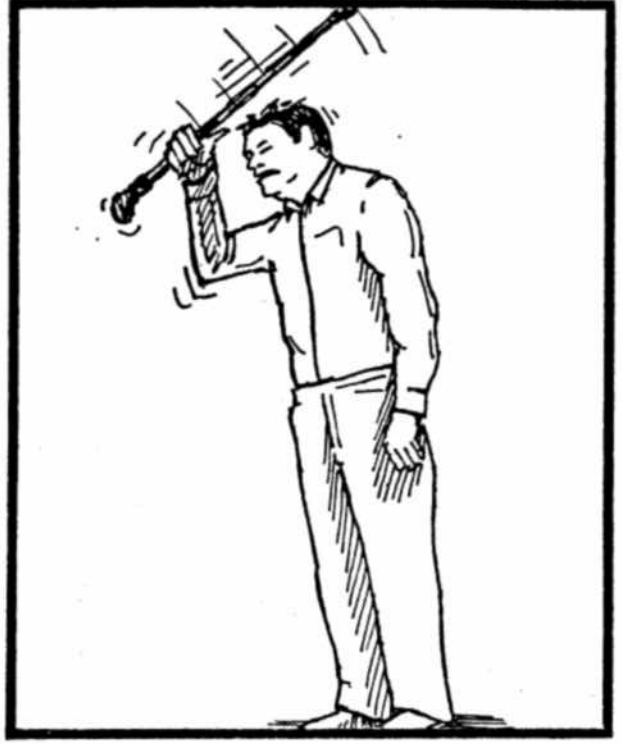

F

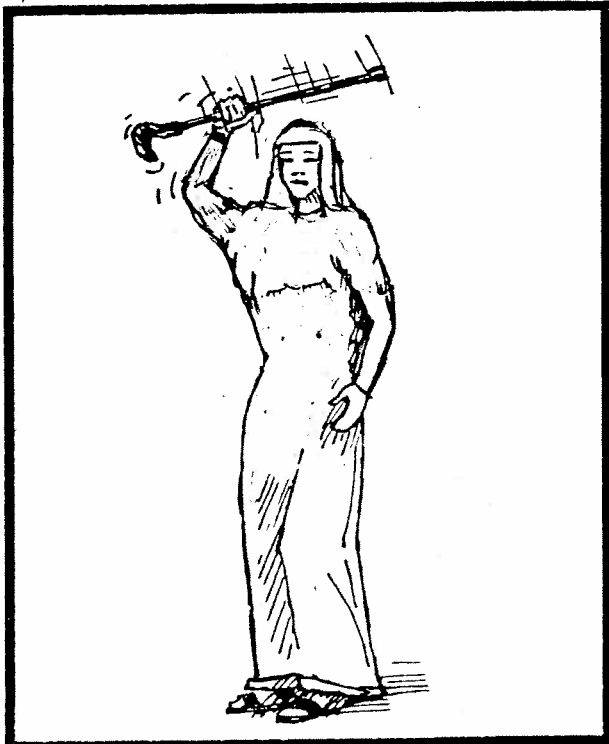

Y



Y

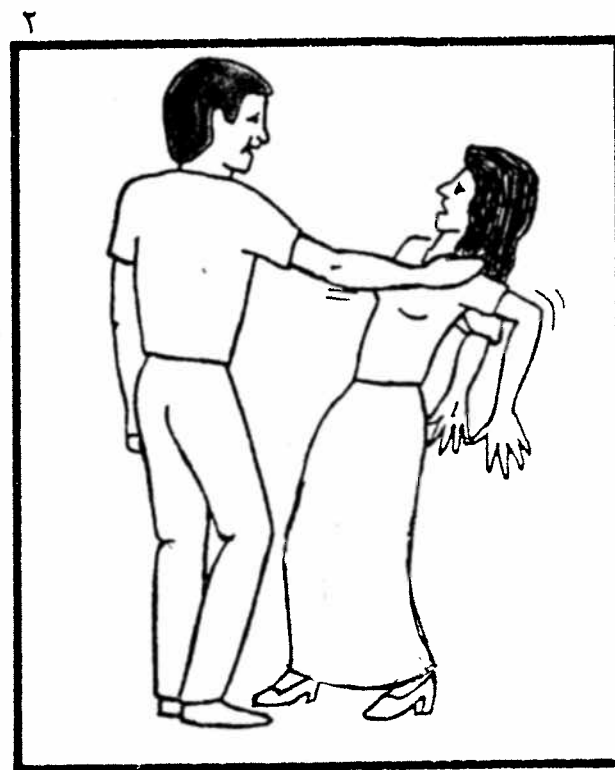
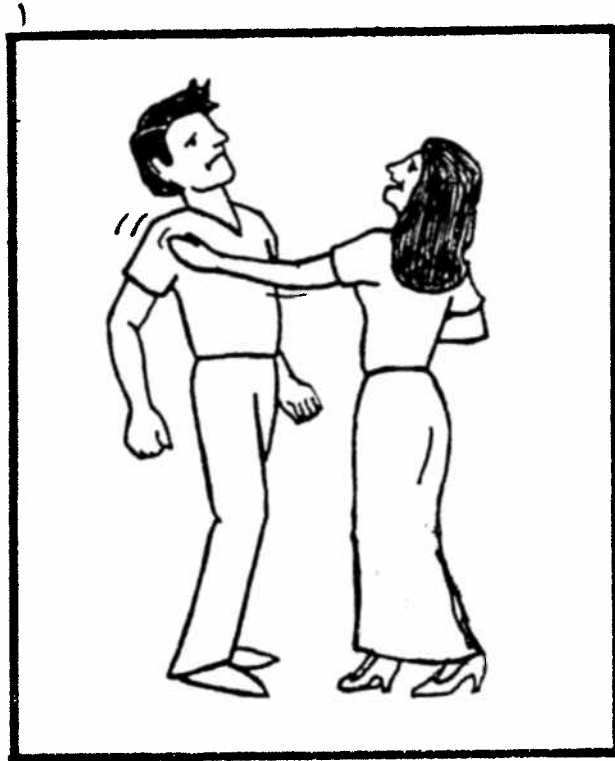

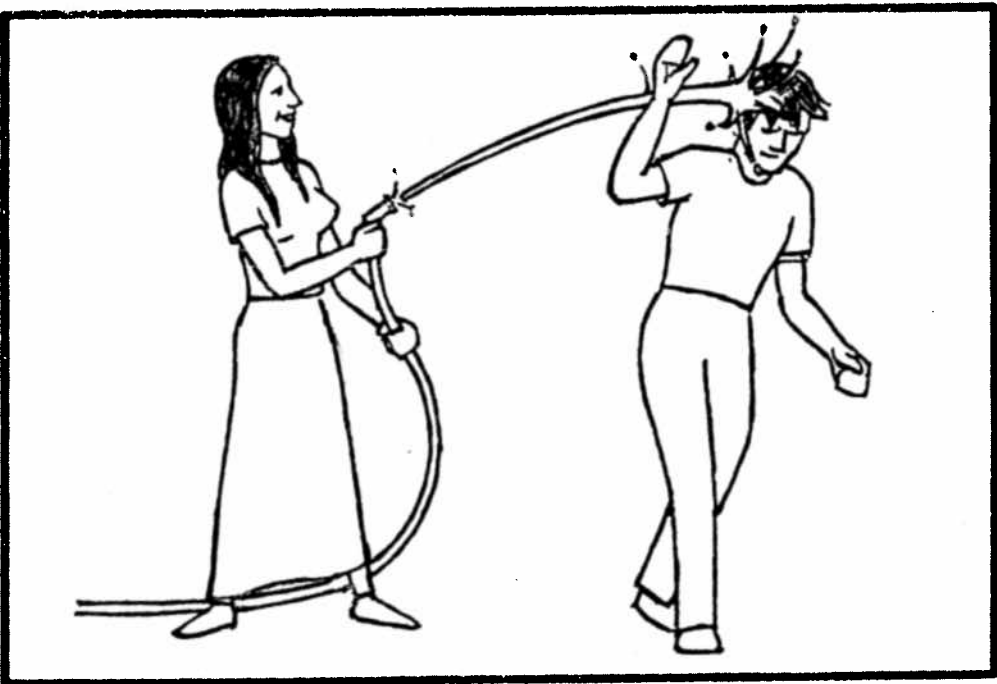
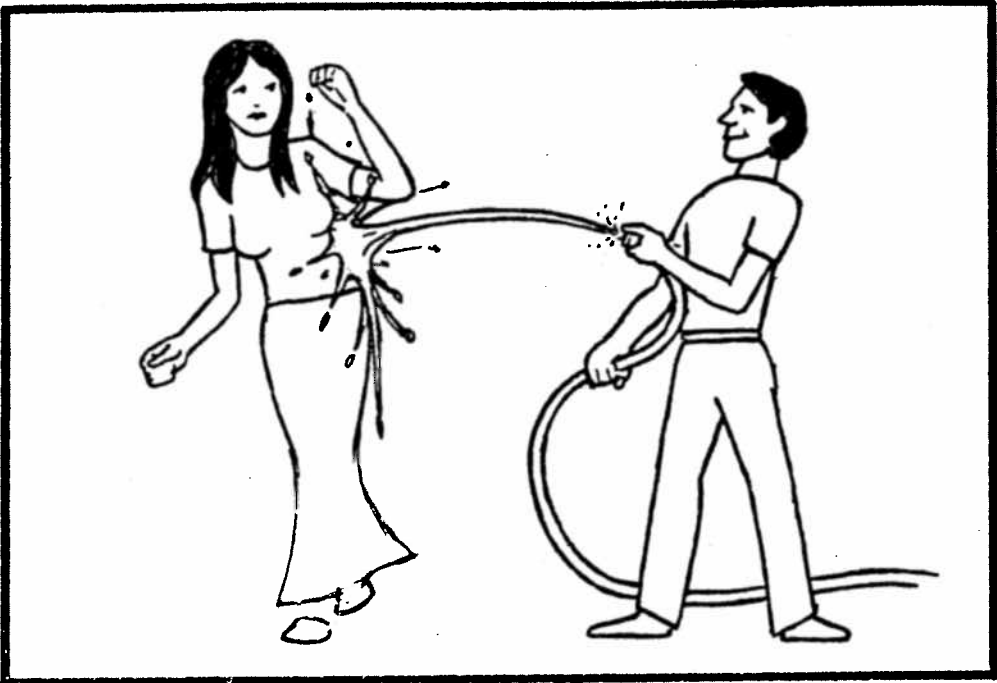

1

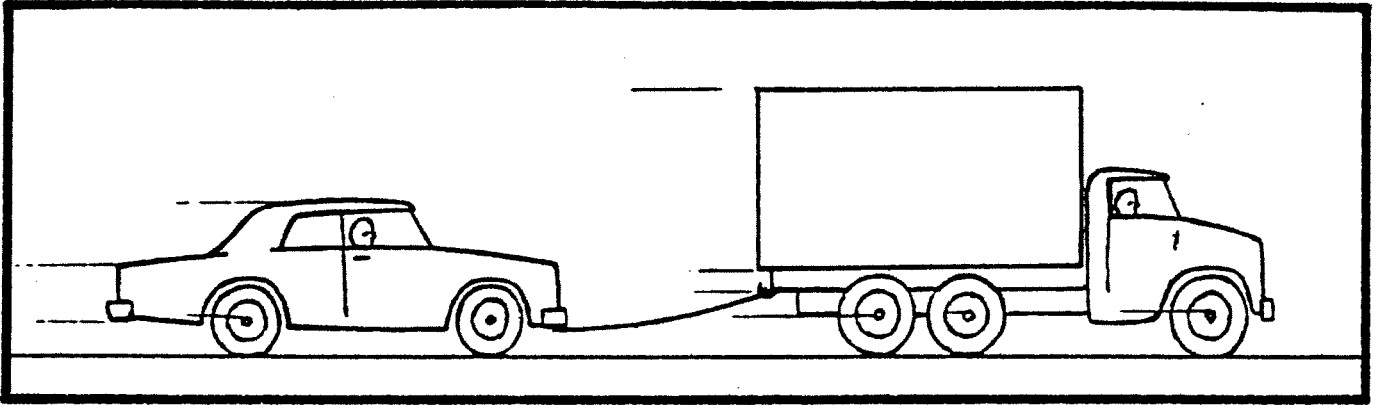

2

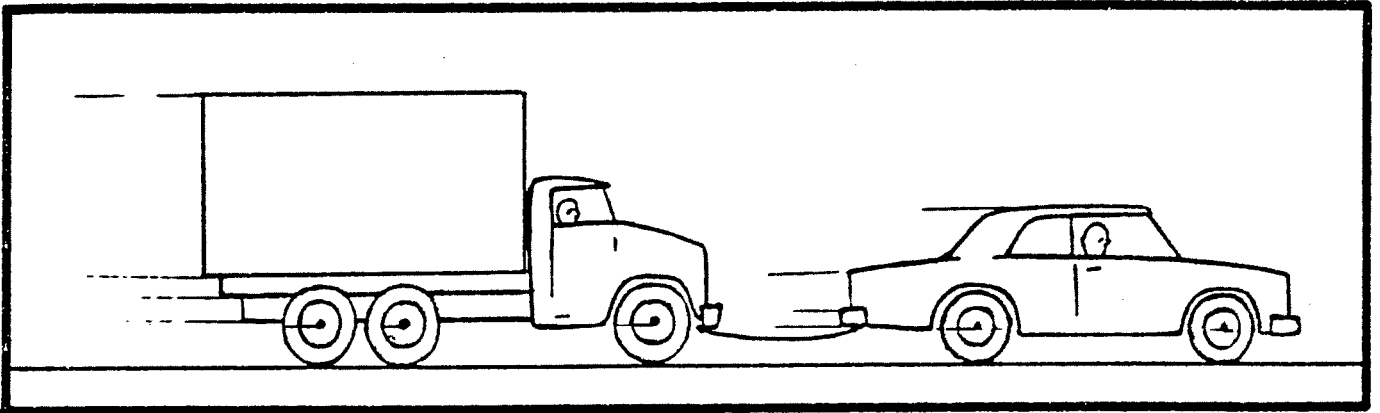

10

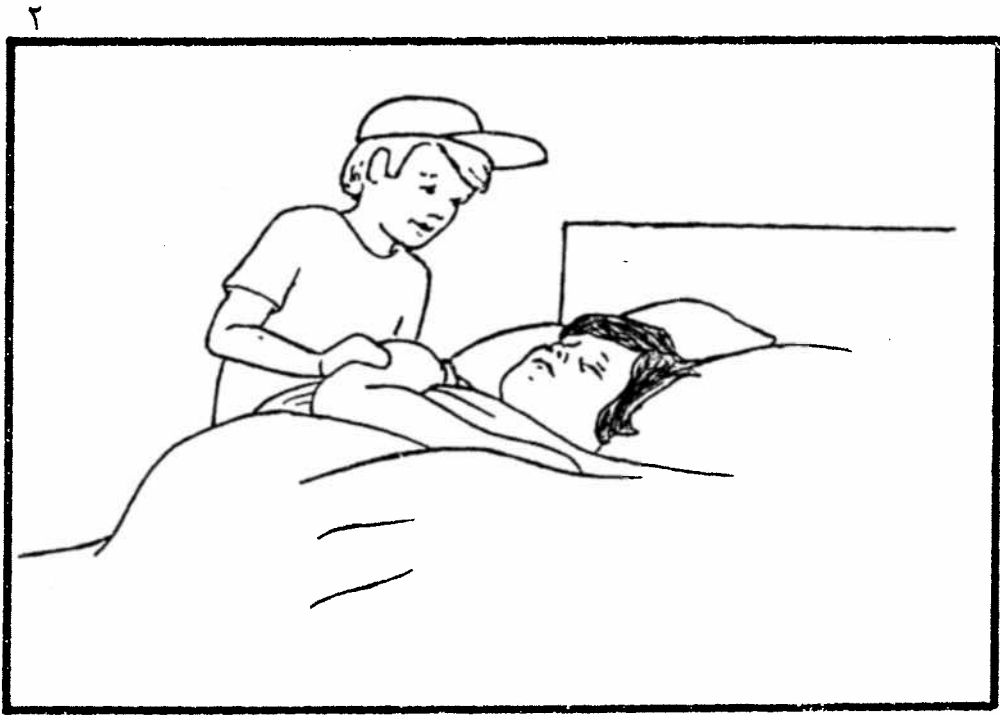
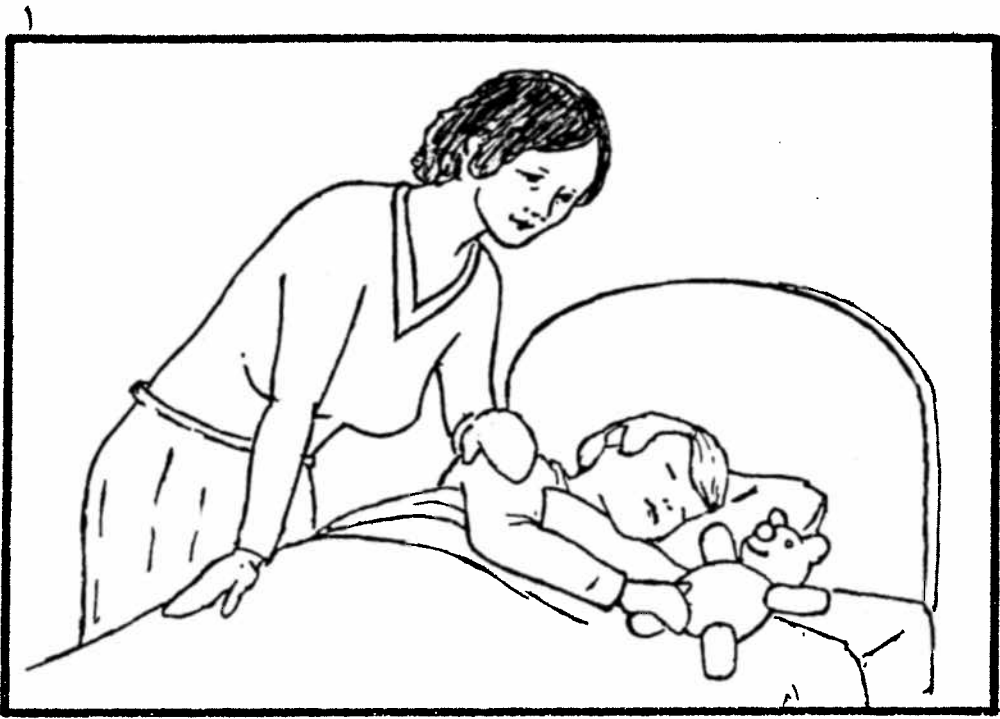

1

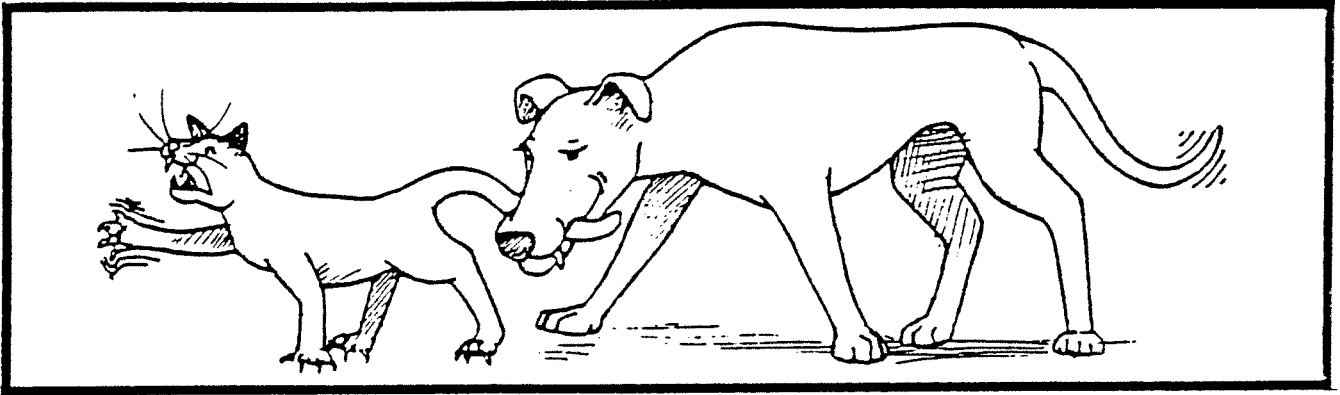

2

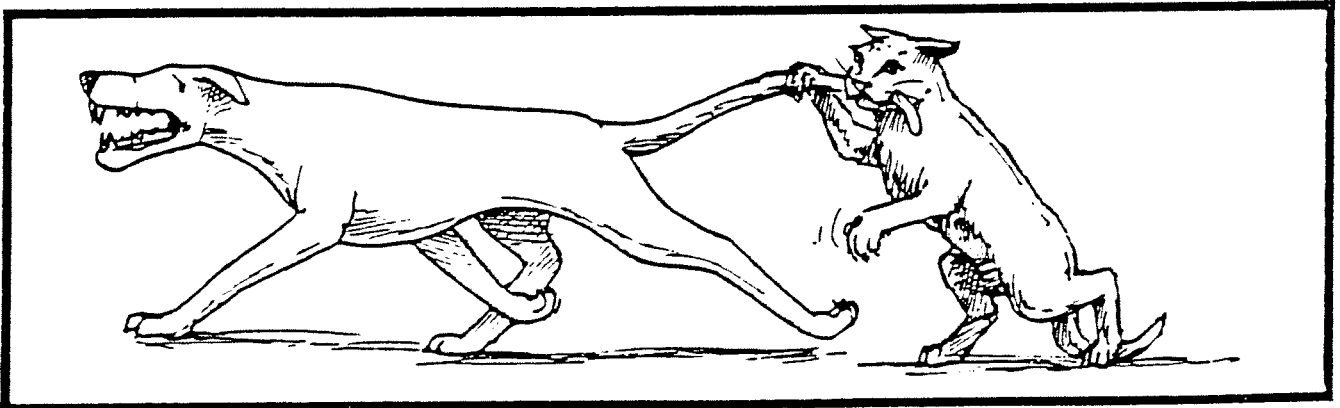

12

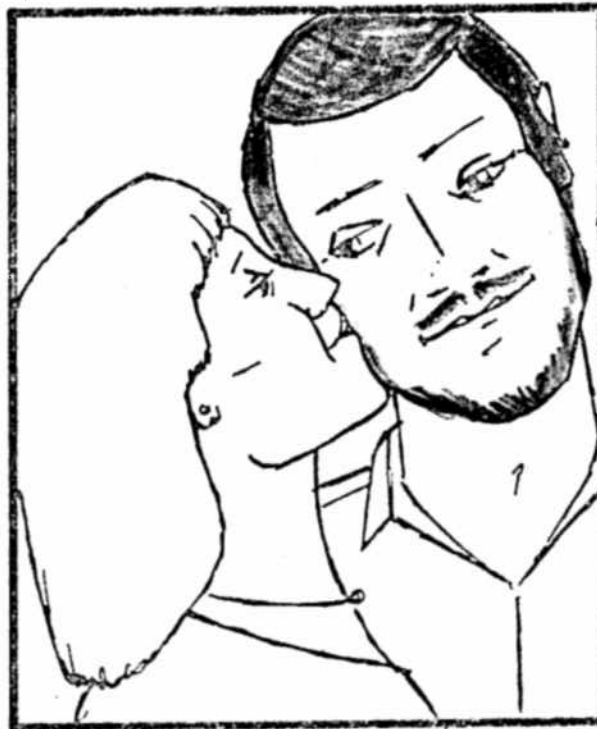
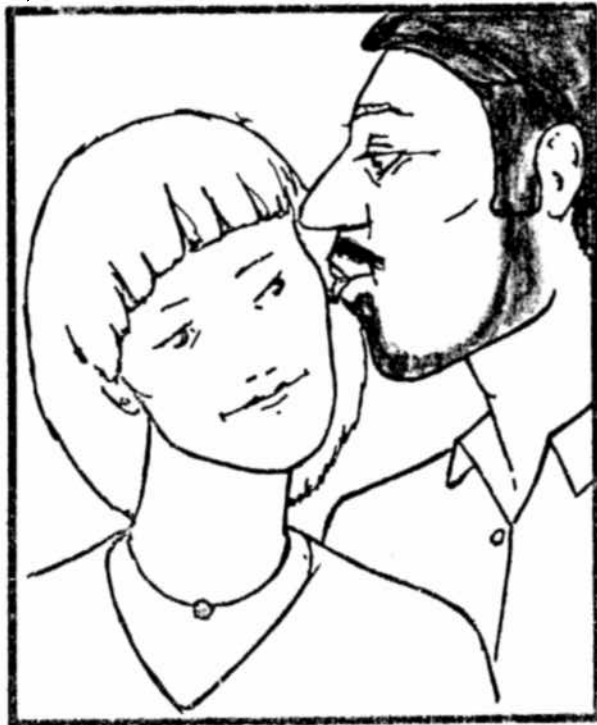



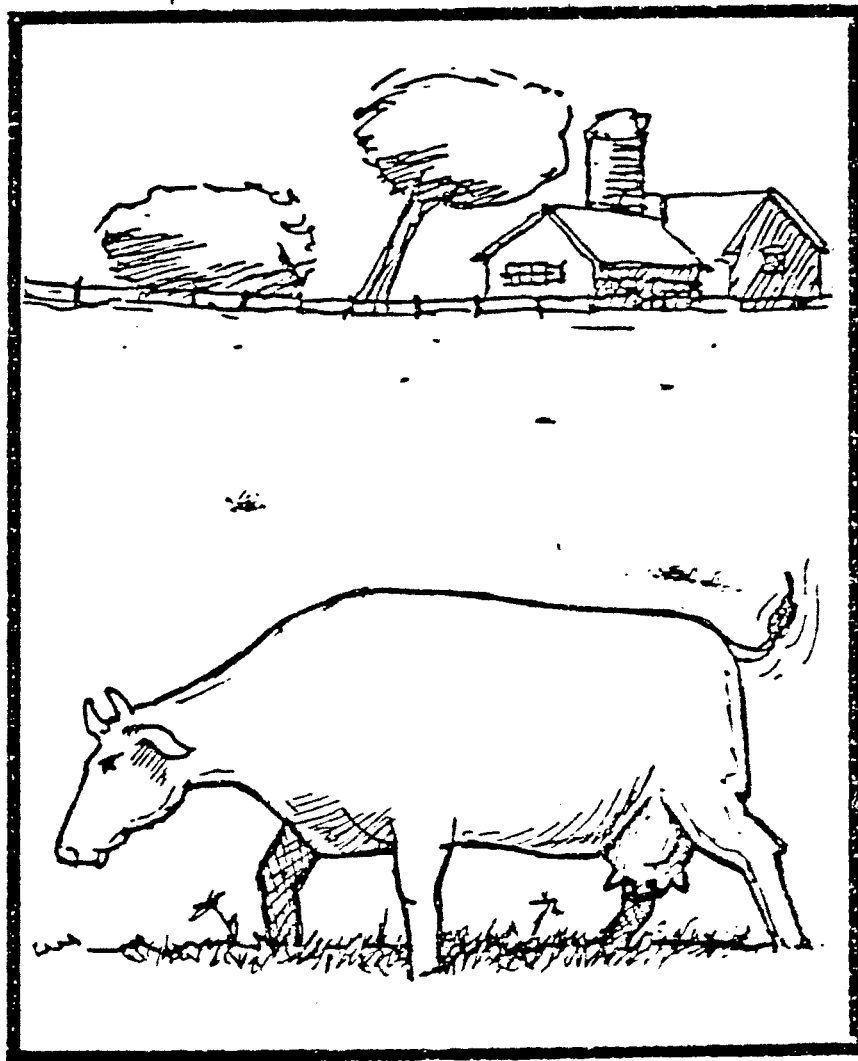

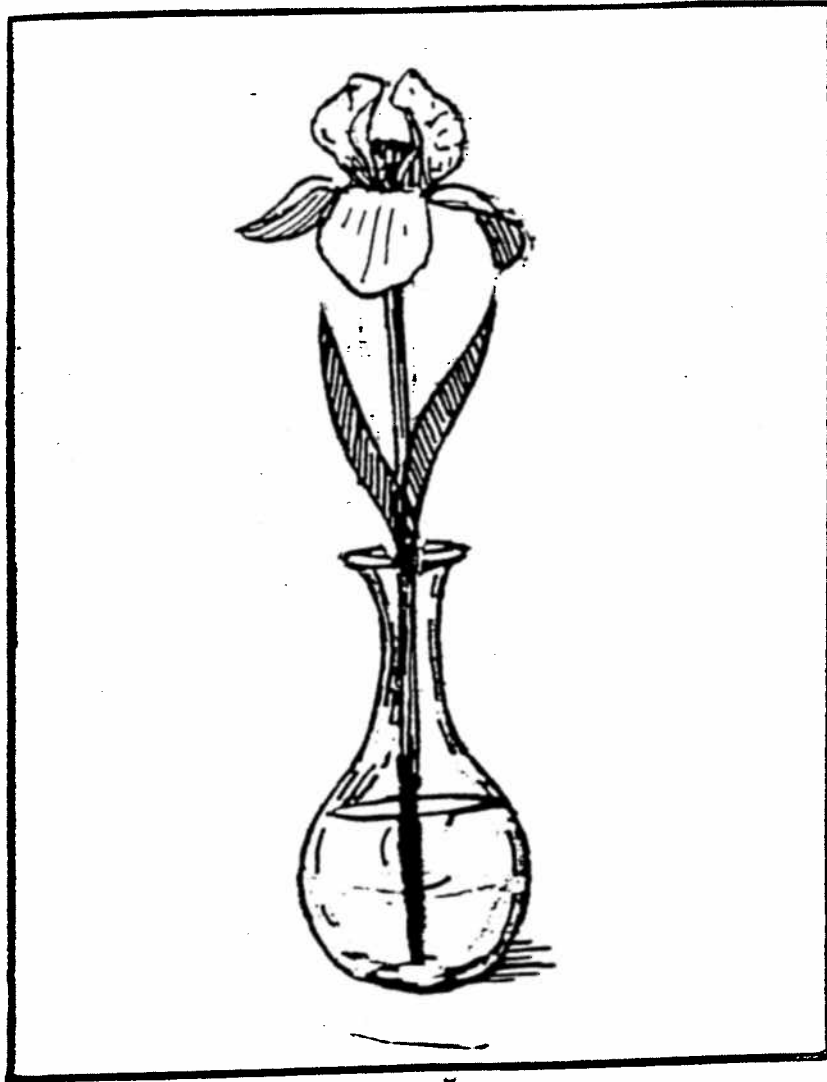

2

1



14



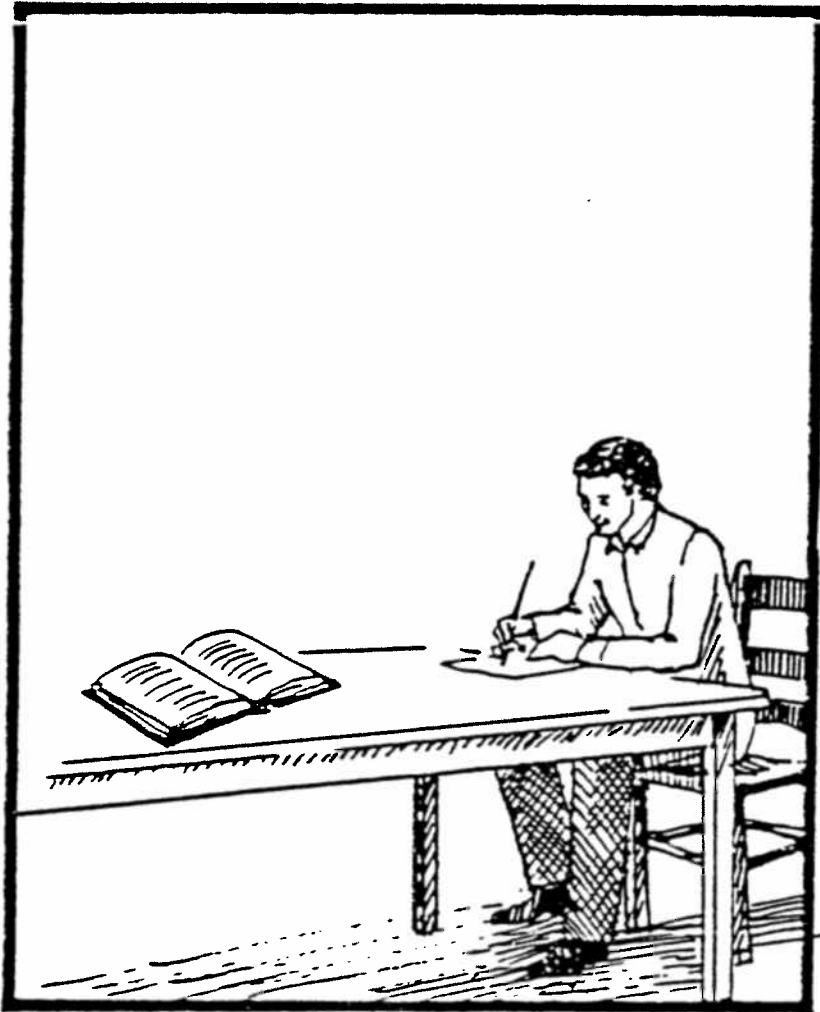



2

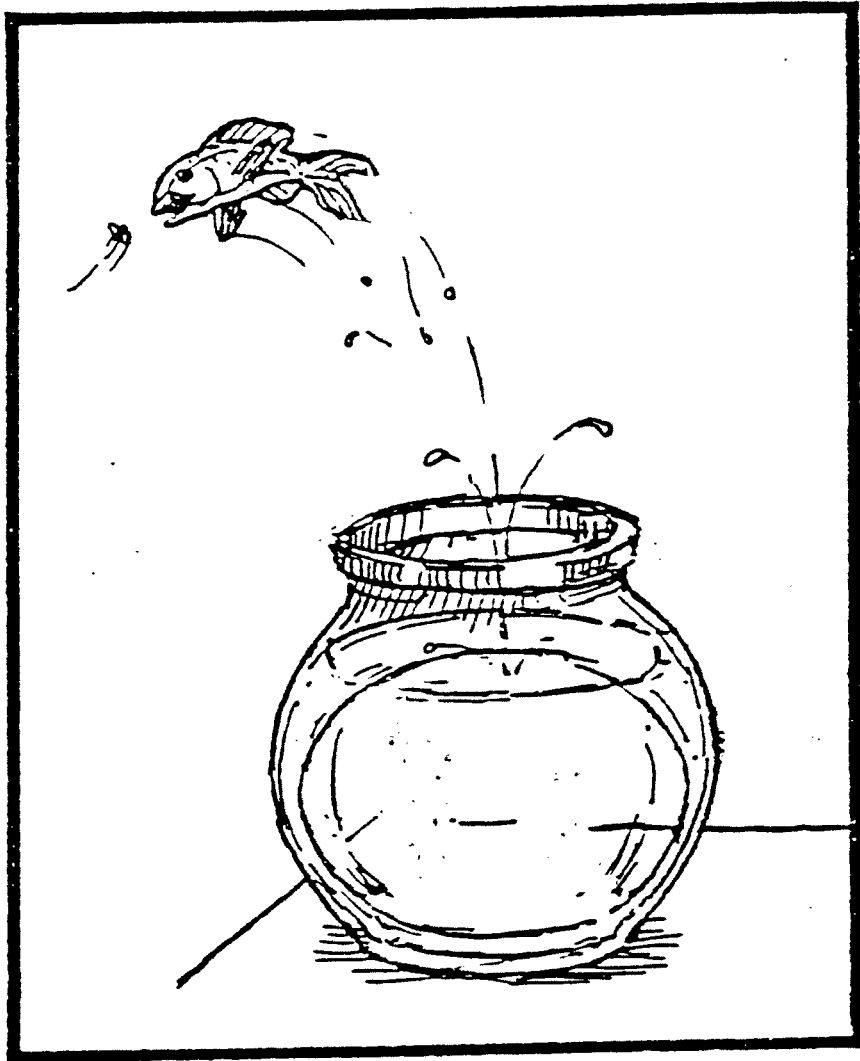

21



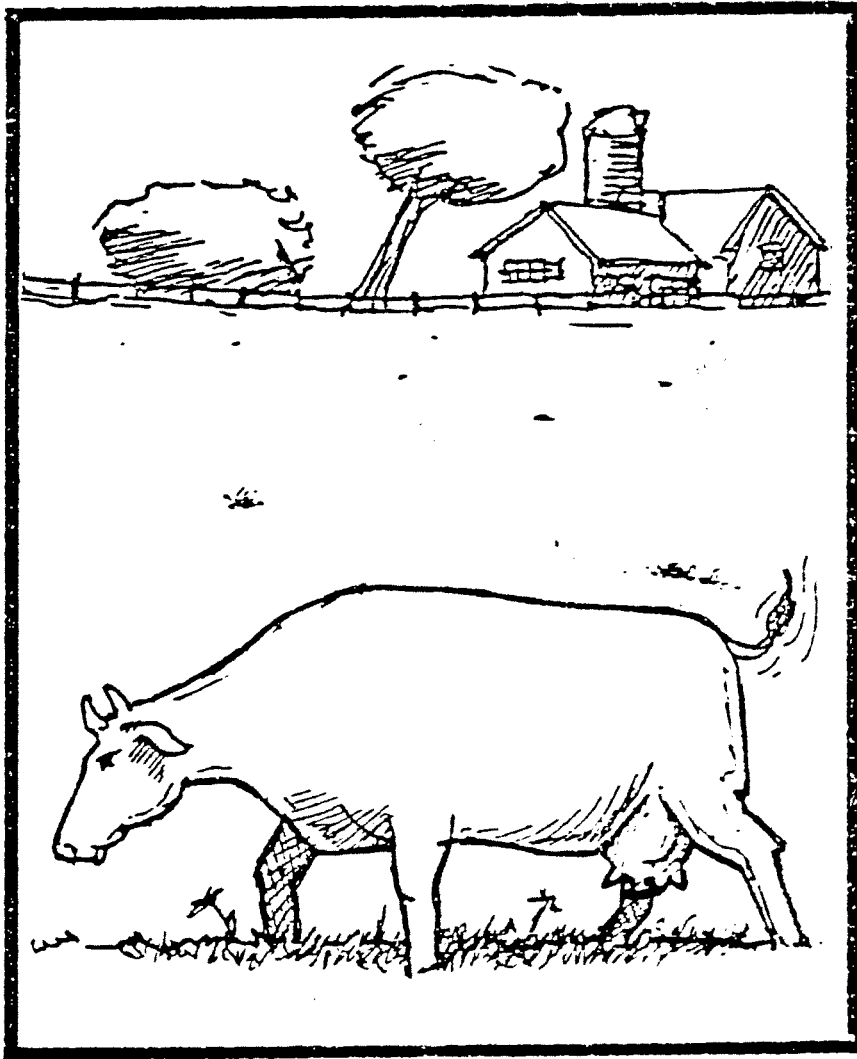

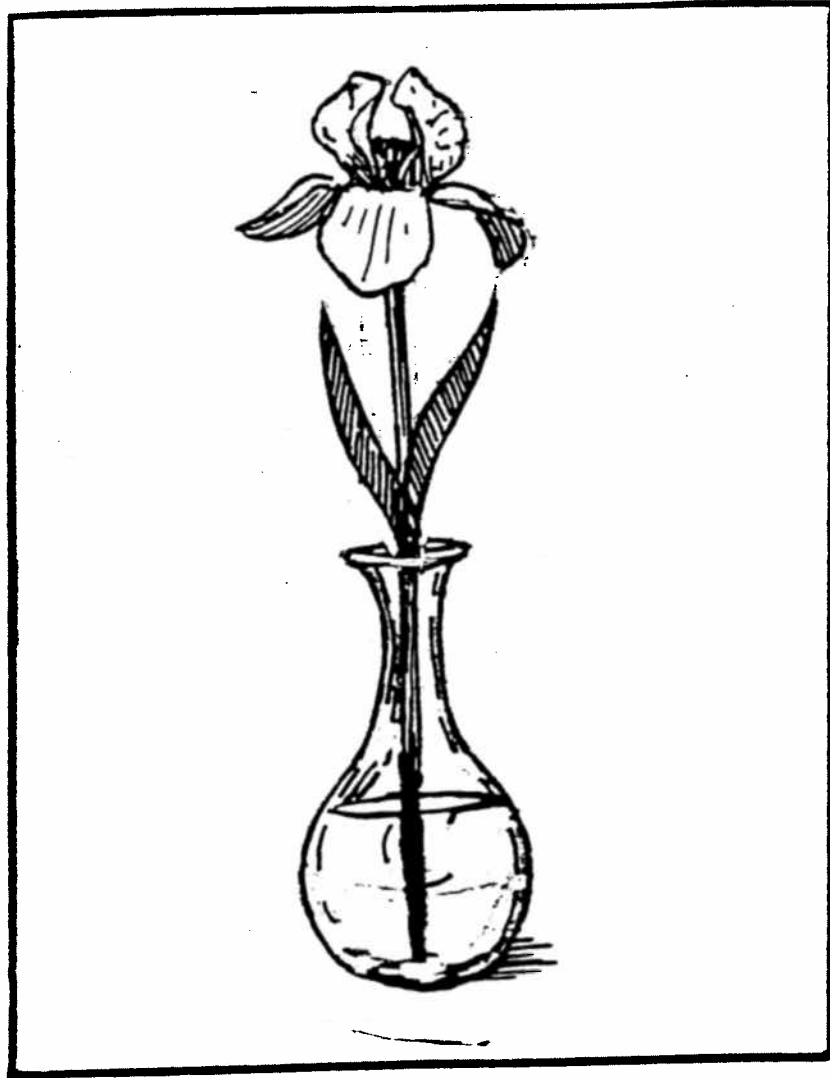

۲۴

۲





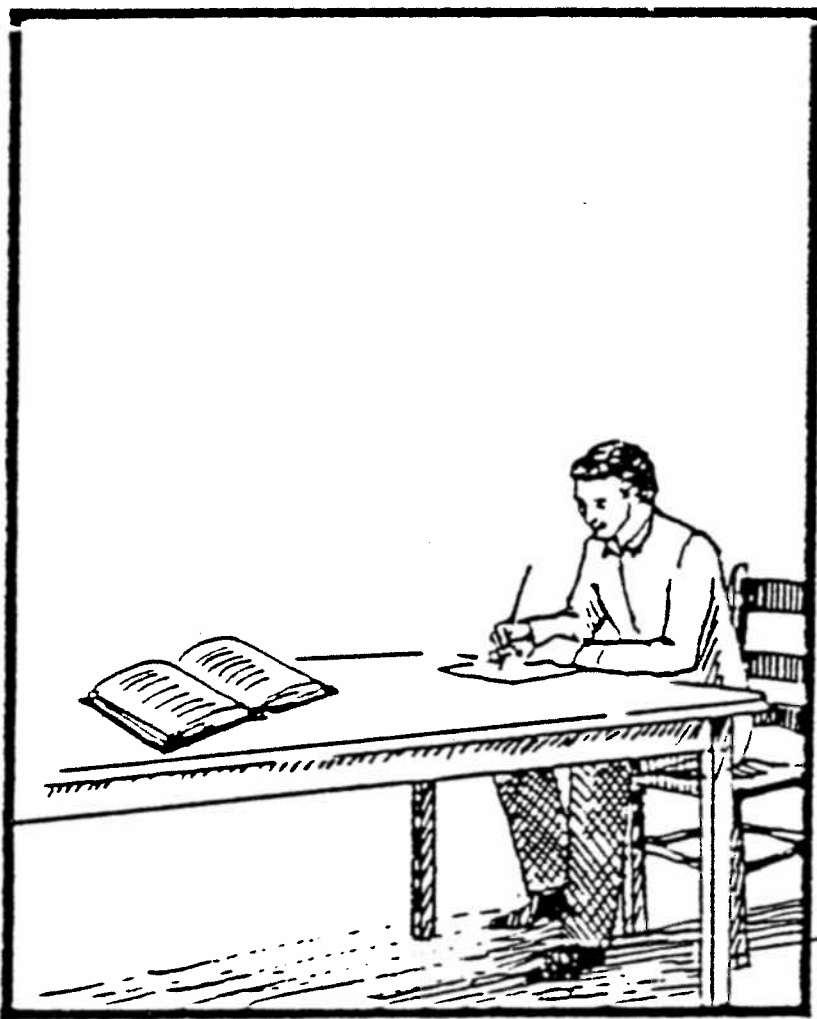

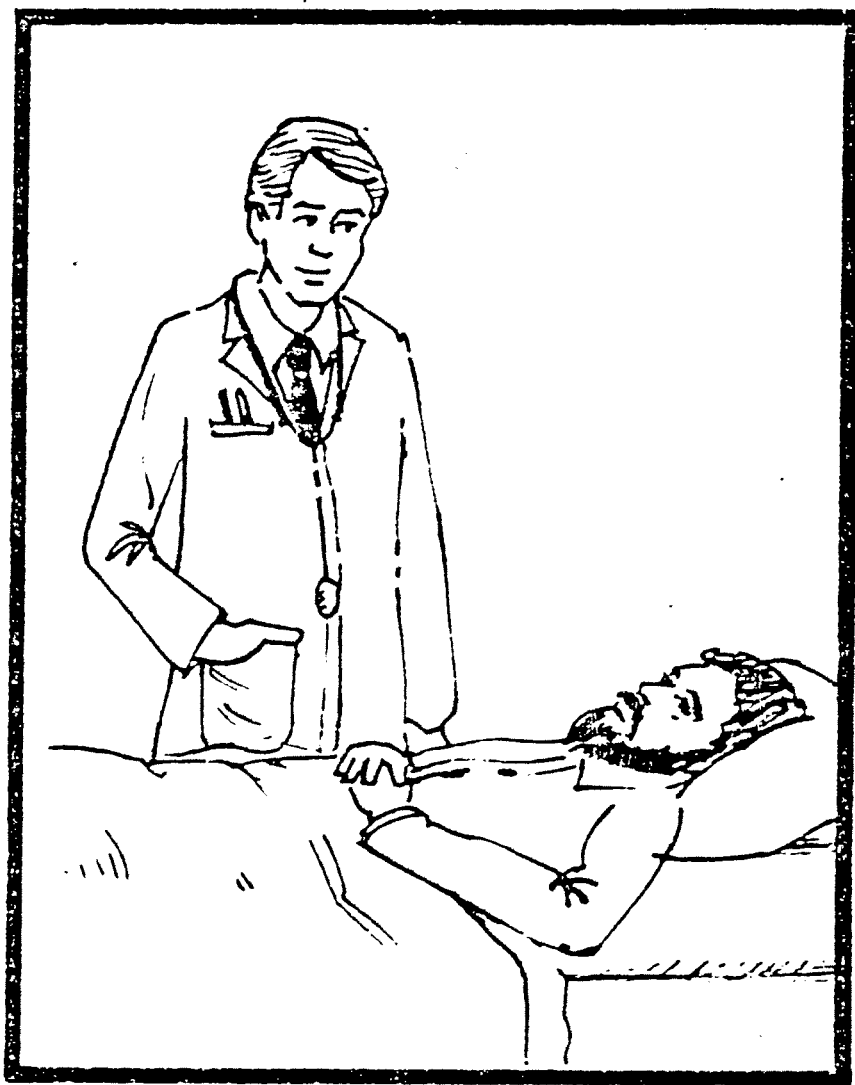

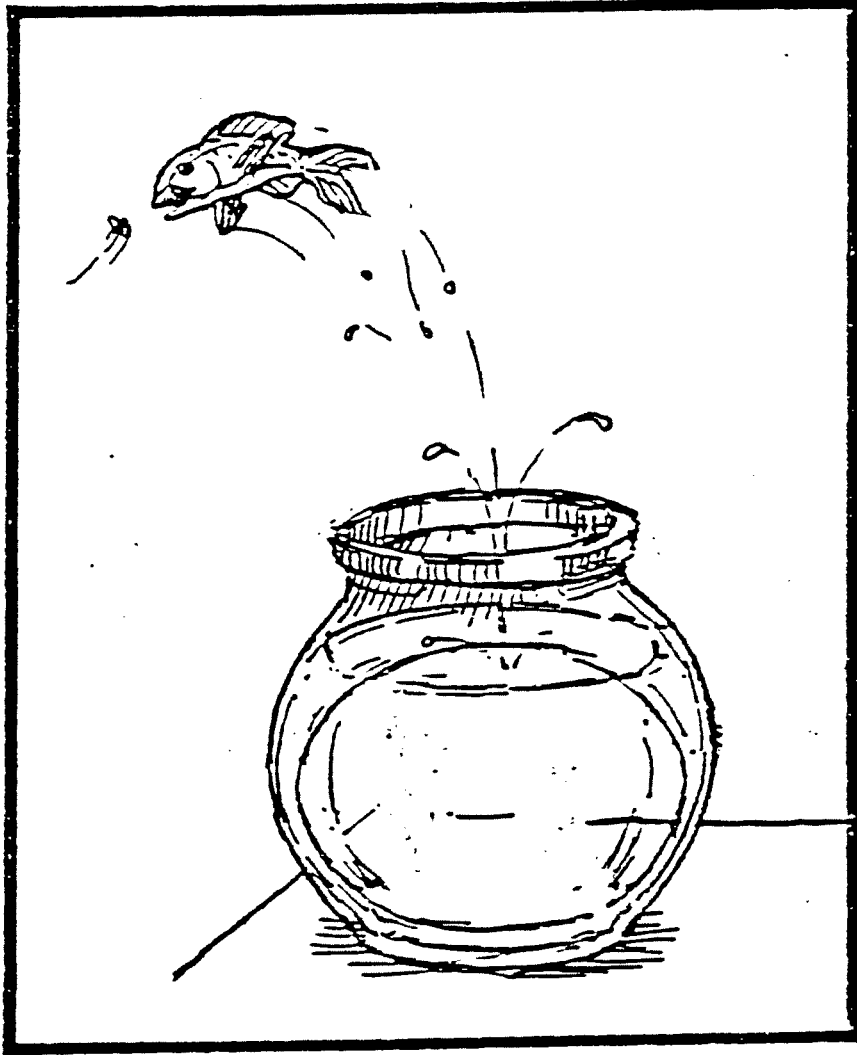

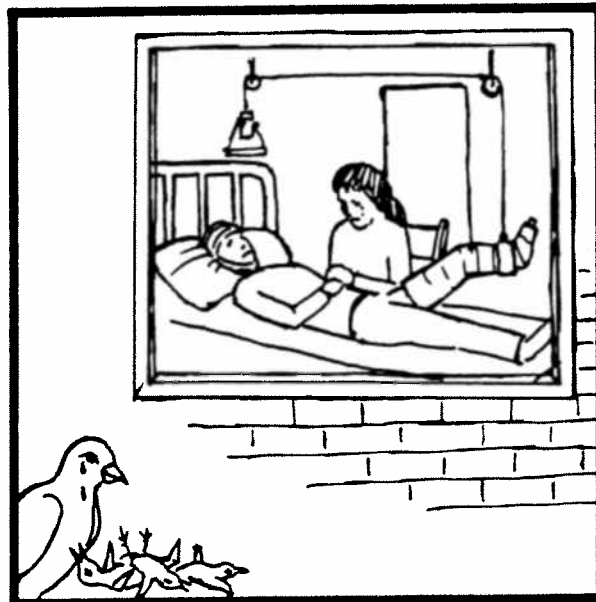
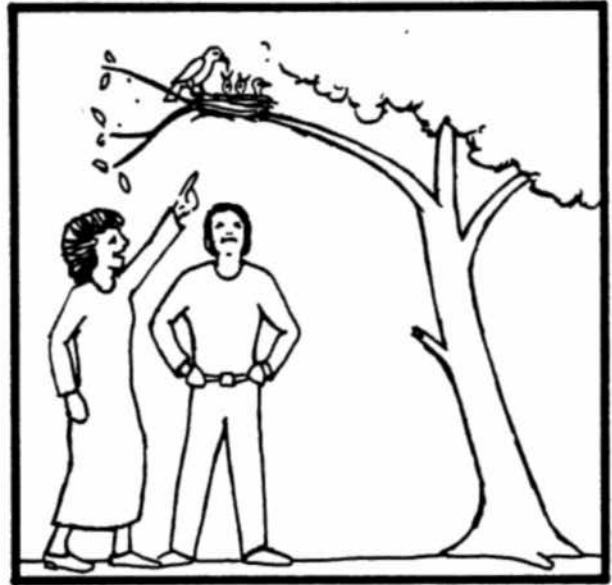

دانه

برده

سر

جنگ

دوش

ریشه

تیر

چاق

بار

خل

دختر پسر را هل می دهد .

پدر به خودش نگاه می کند .

سگ را گربه گاز می‌گیرد .

این کامیون است که سواری را می‌کشد

زن آن مرد را نمی بوسد .

کامیون را سواری نمی کشد .

این سگ است که گربه گازش می‌گیرد .

آنها دنبال او می‌دوند .

خودش را آن زن میزند .

سواری را کامیون نمی‌کشد .

زنی با پسرش برای جمع کردن هیزم به جنگل رفت .

او مقداری هیزم جمع کرد و در راه بازگشت به دهکده، به منزل
خواهرش رفت و هیزم‌ها را با تخم مرغ عوض کرد .

شیشه

چنگ

تور

پرده

خانه

تصویرهای بخش درک خواندن کلمات

۲



۱

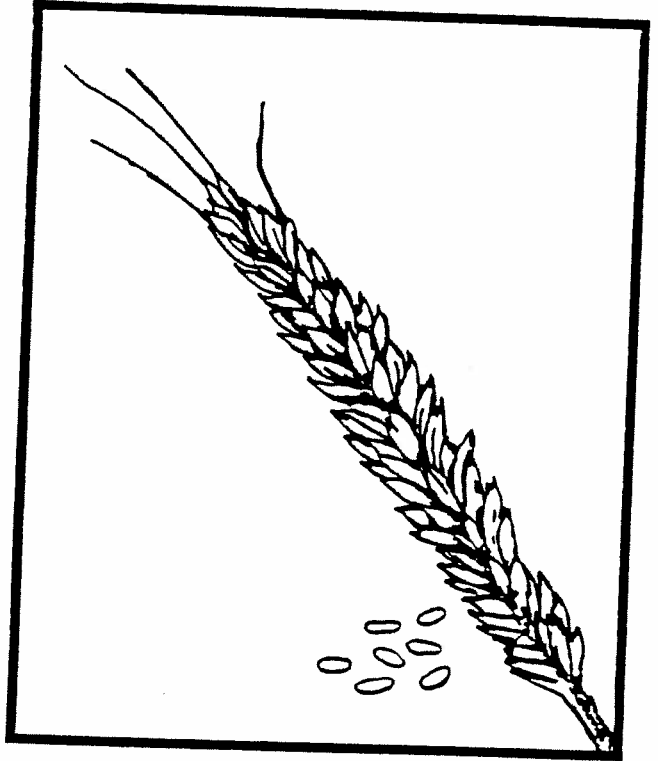

۴

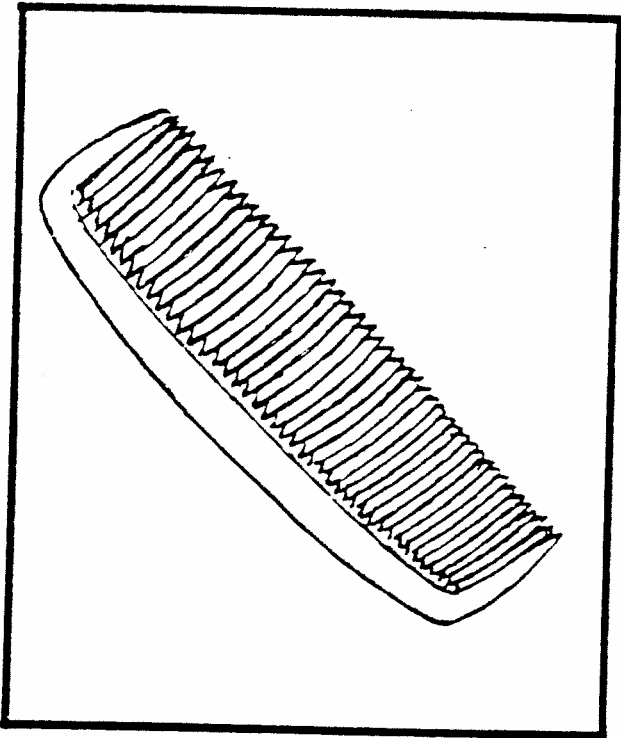

۳



۴۰۸

دانه

γ

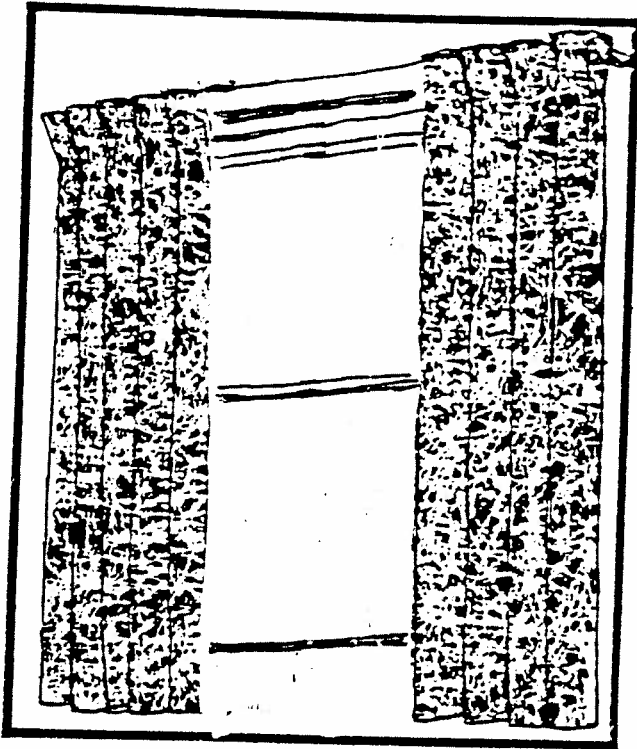

γ

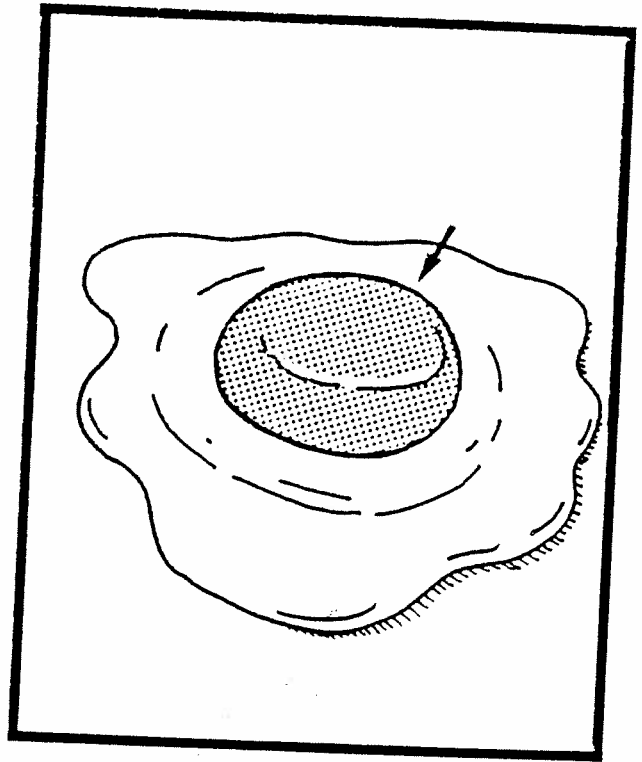

γ



γ

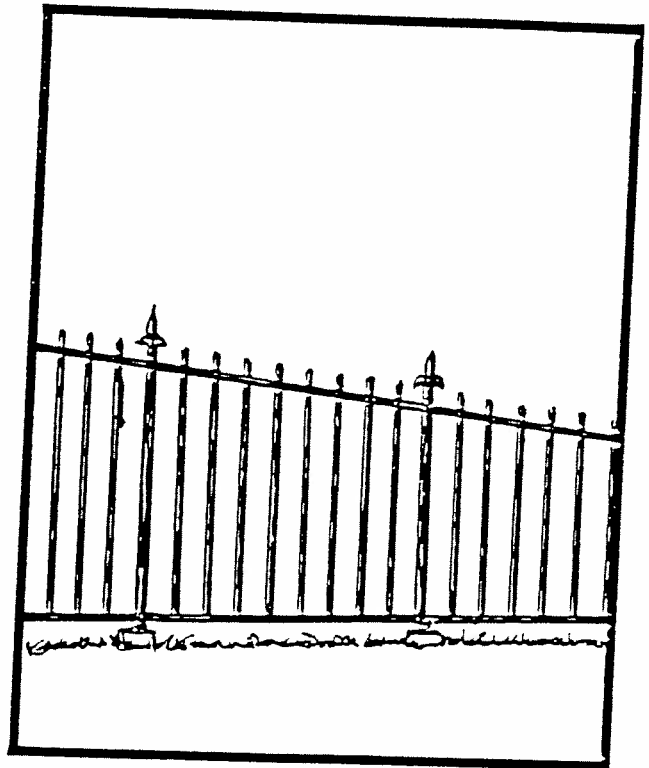

برده

2

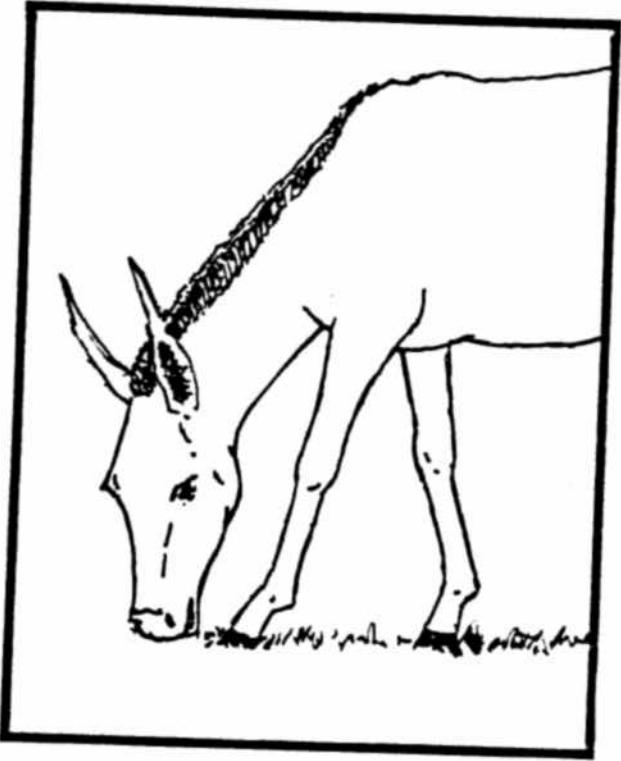

1

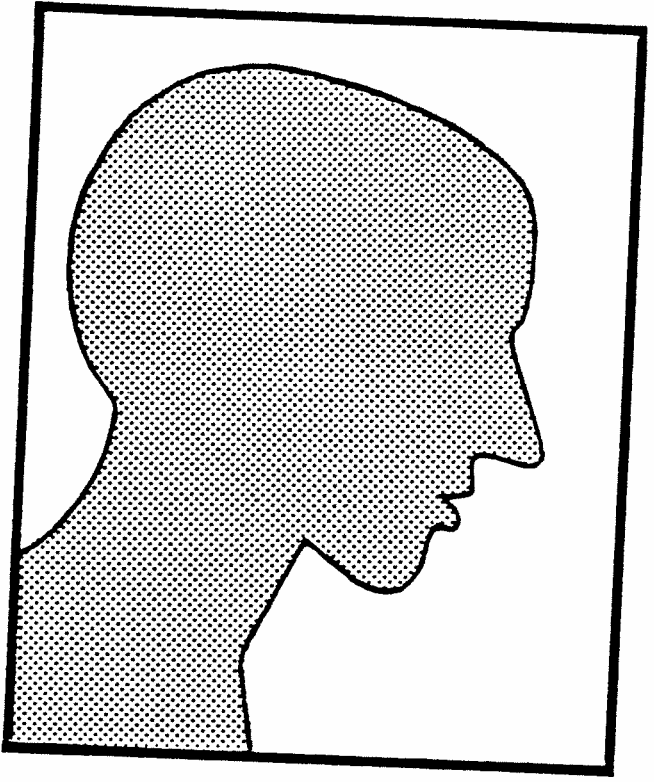

4

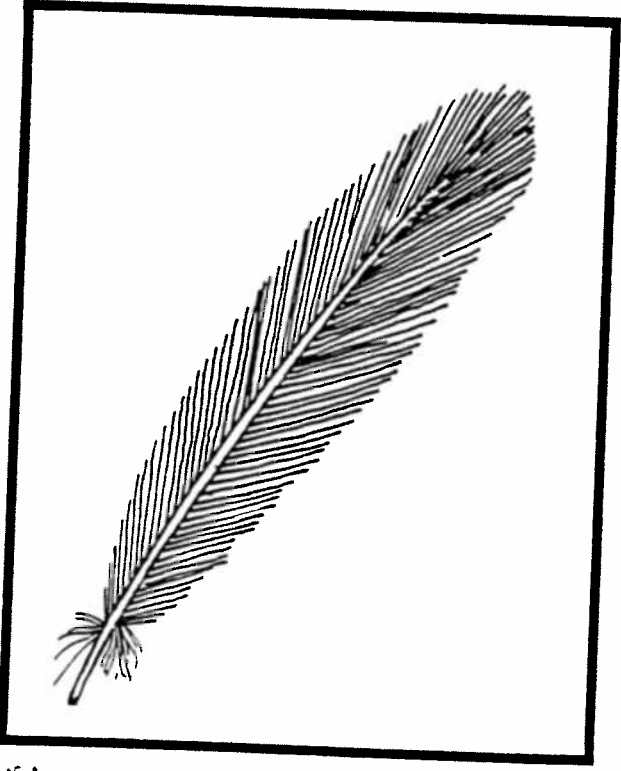

2

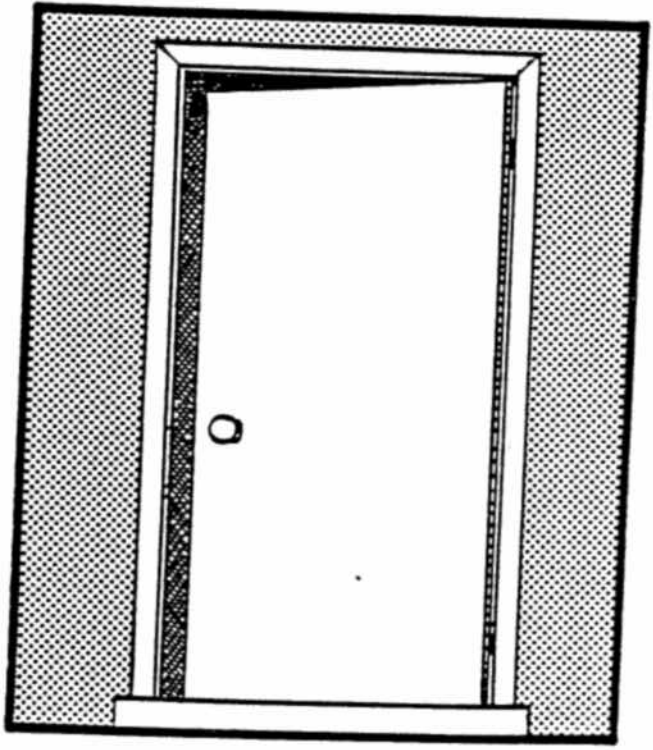

سر

2

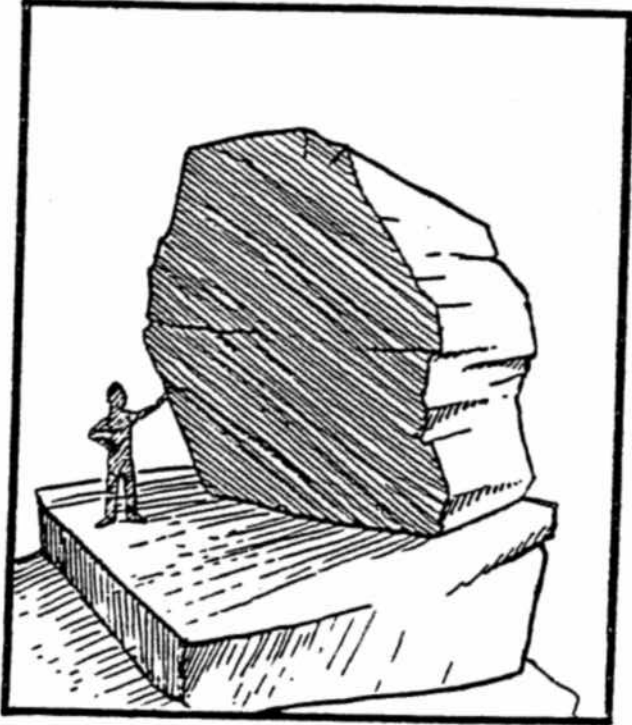

1

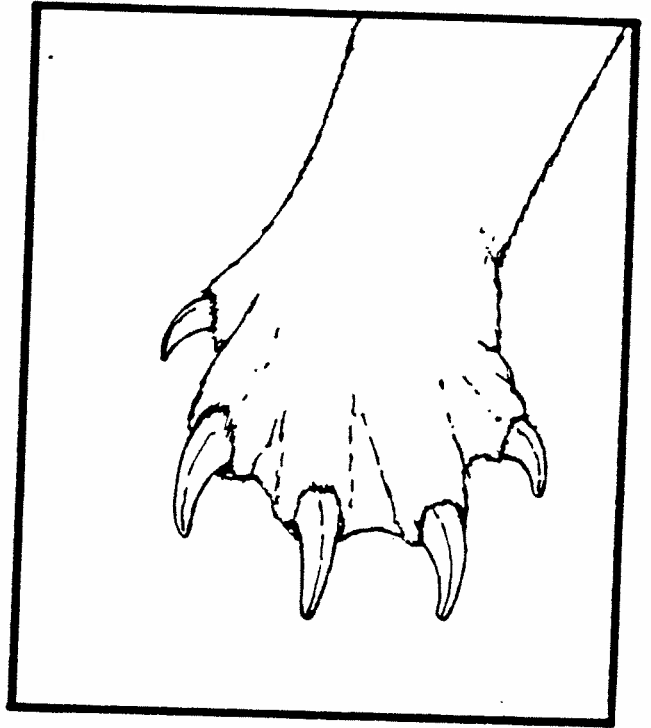

2

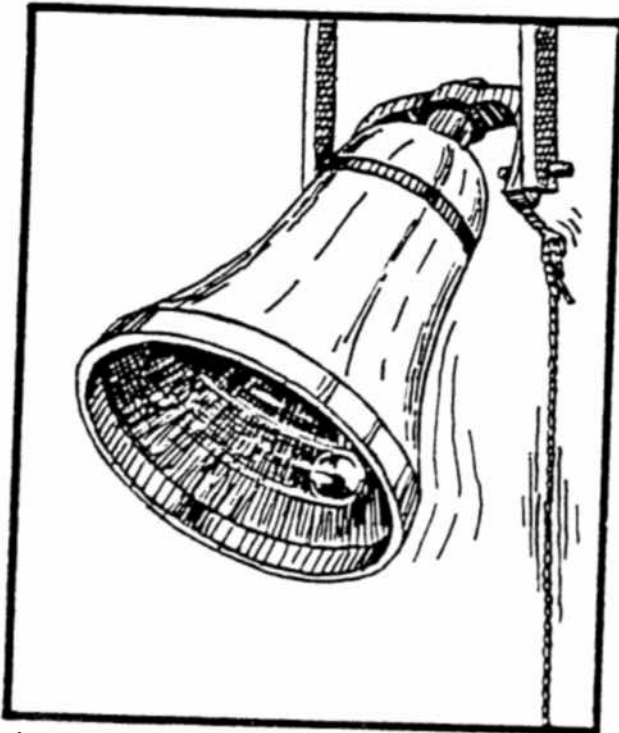

2

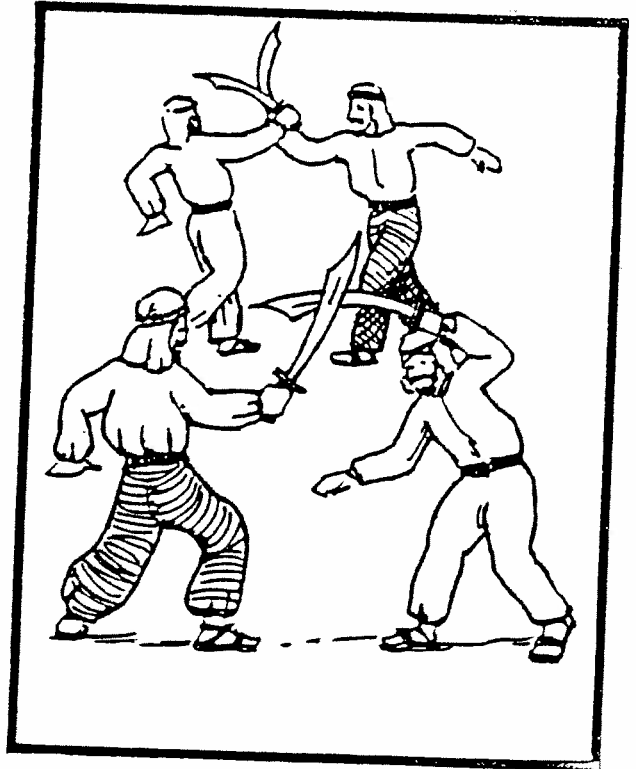

F11

جنگ

2

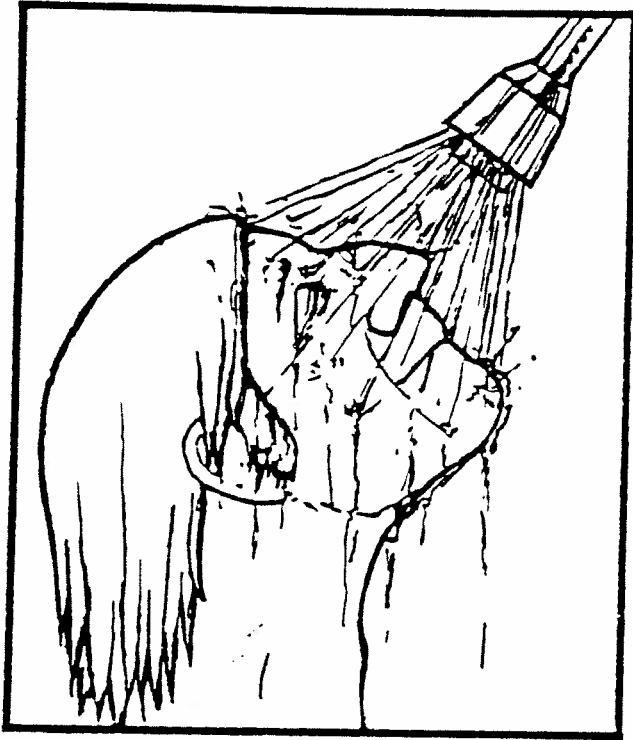

1

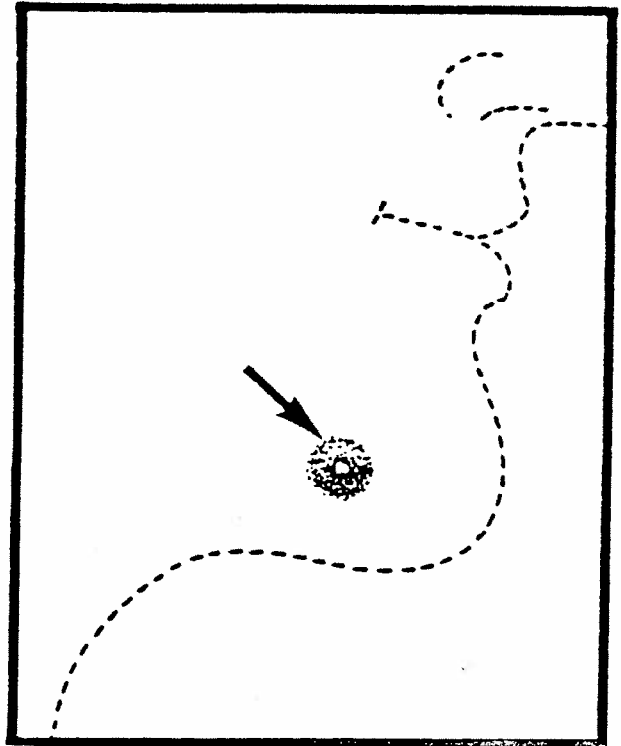

4

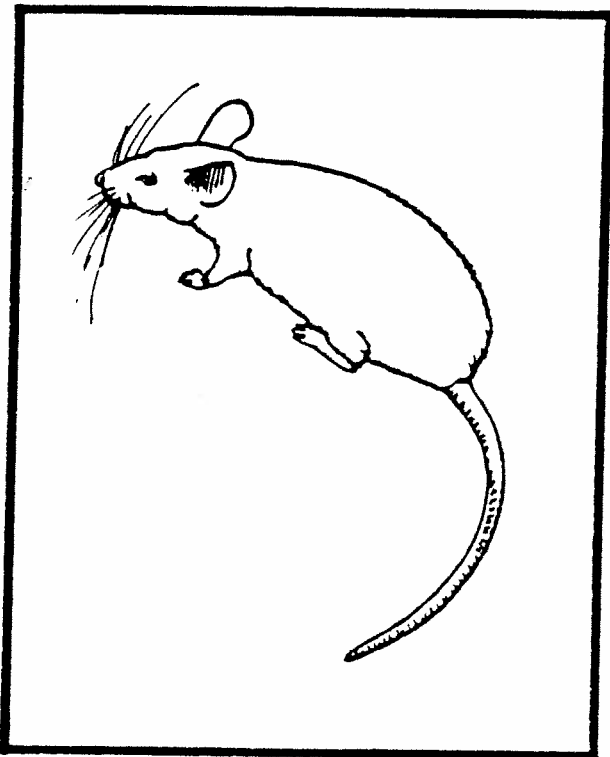

3

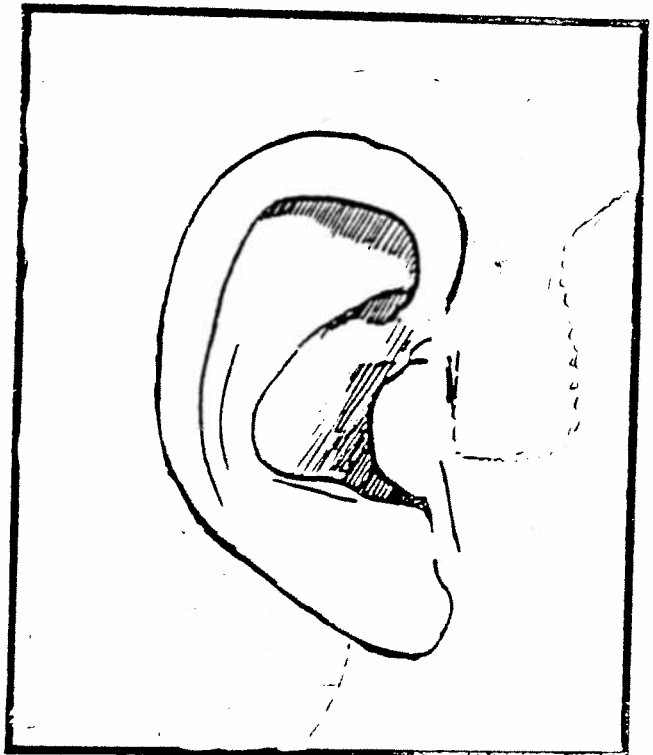

412

دوش

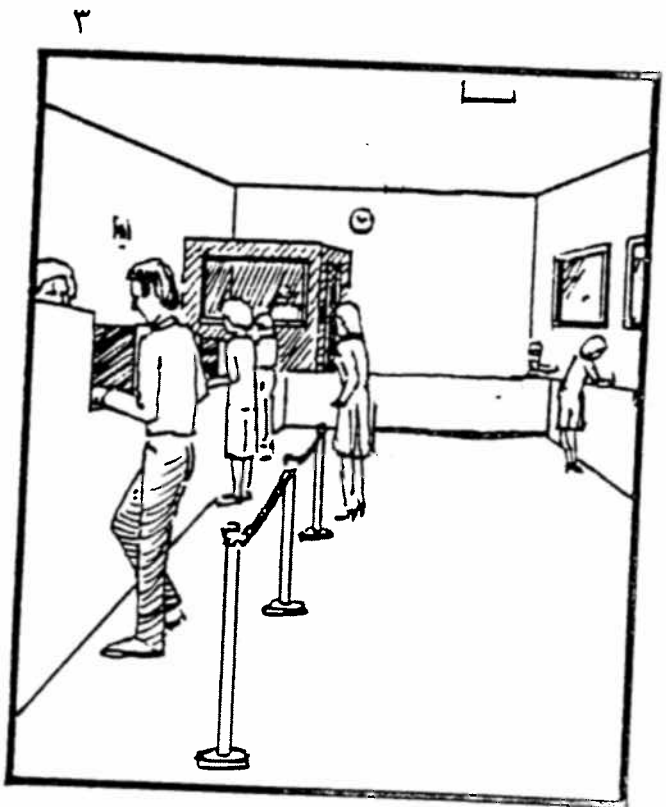
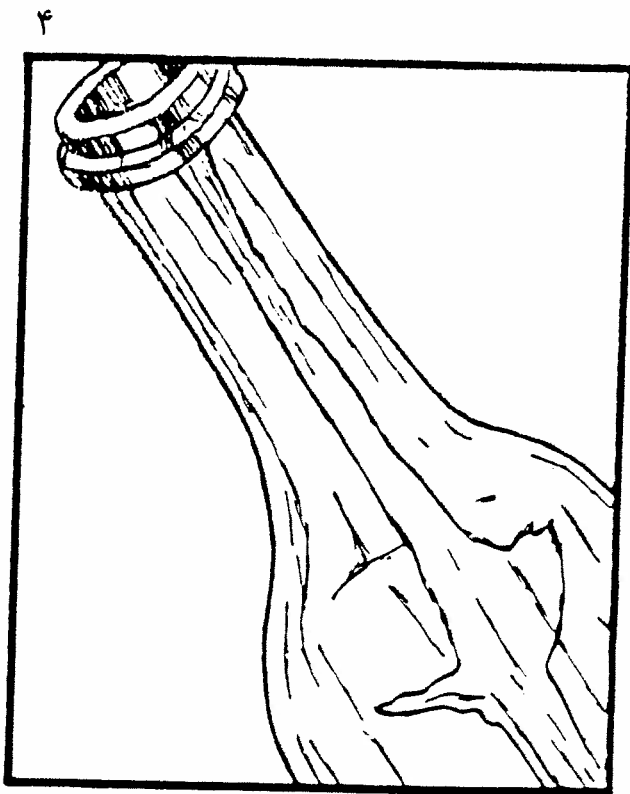
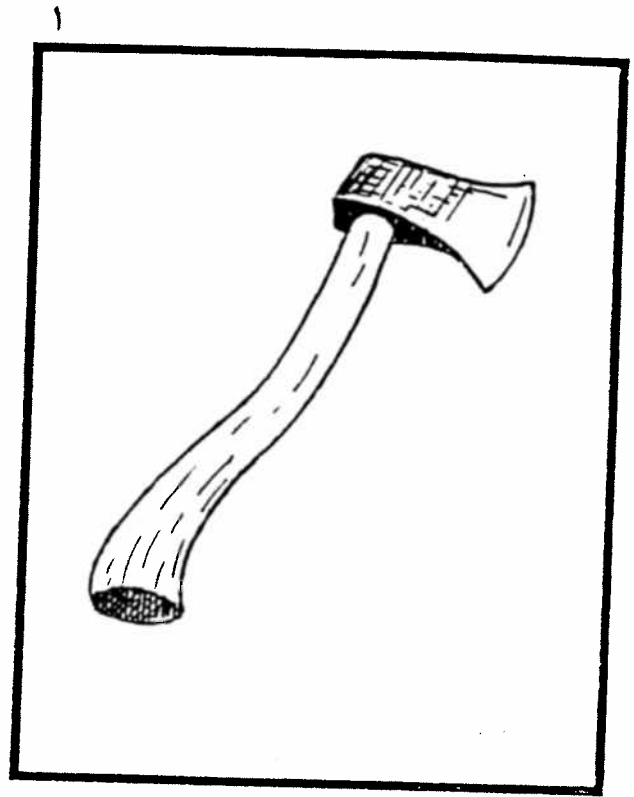
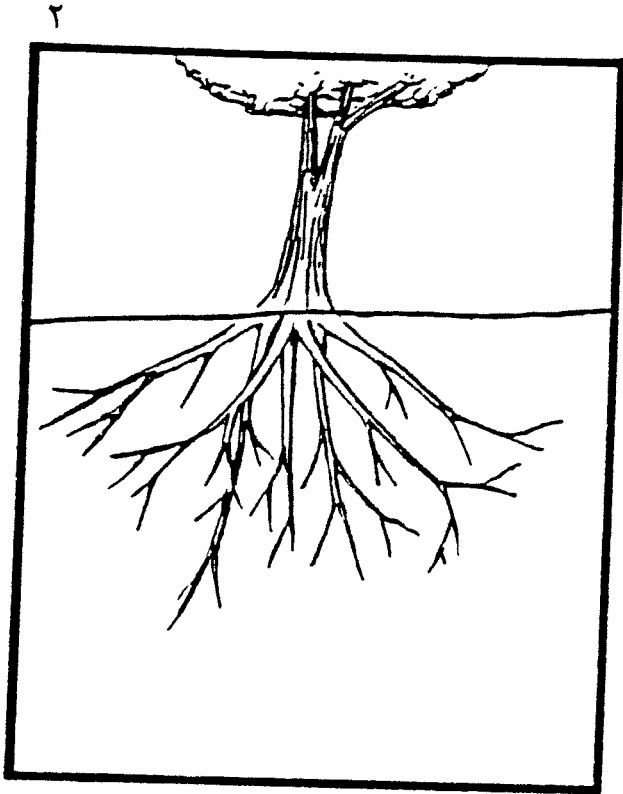

212

ریشه

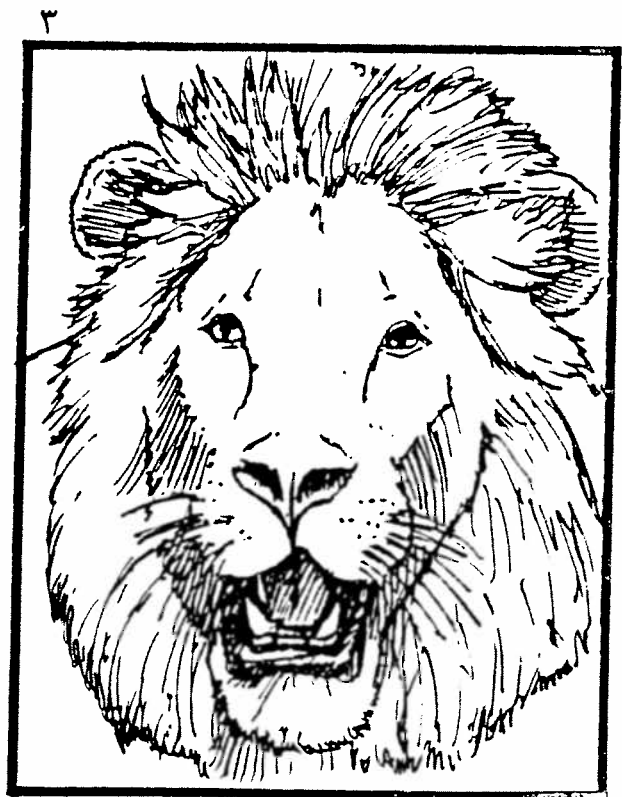
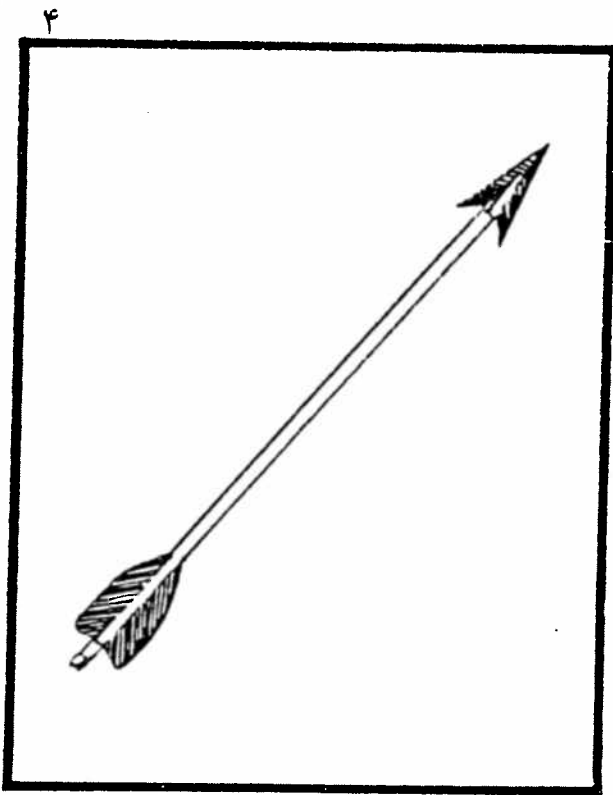
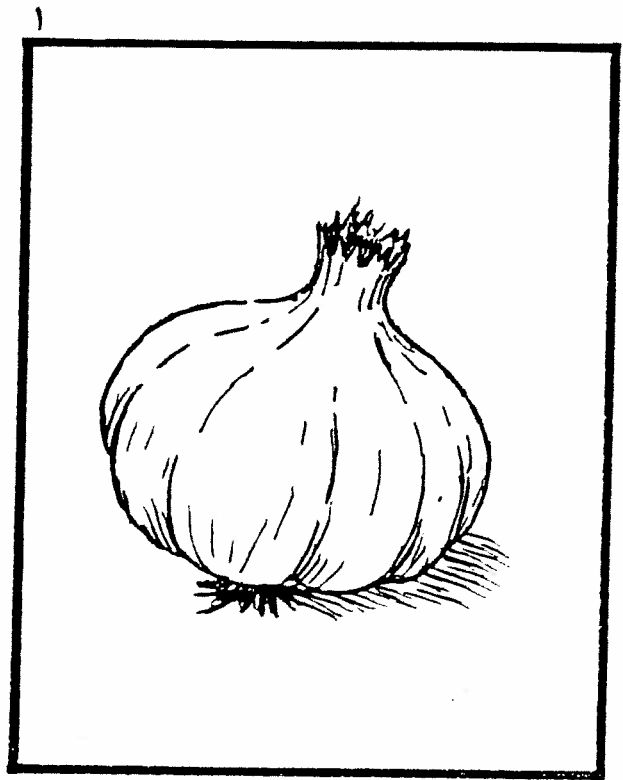

414

تیر

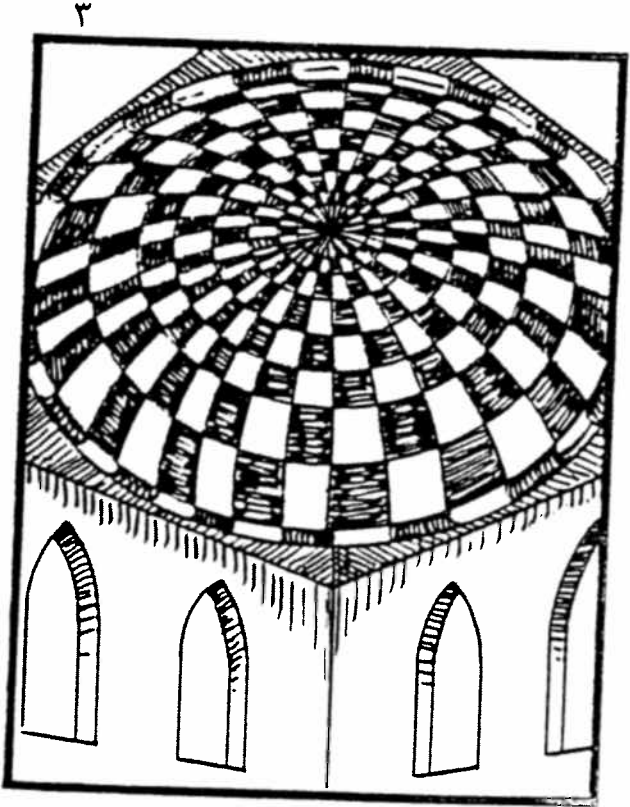
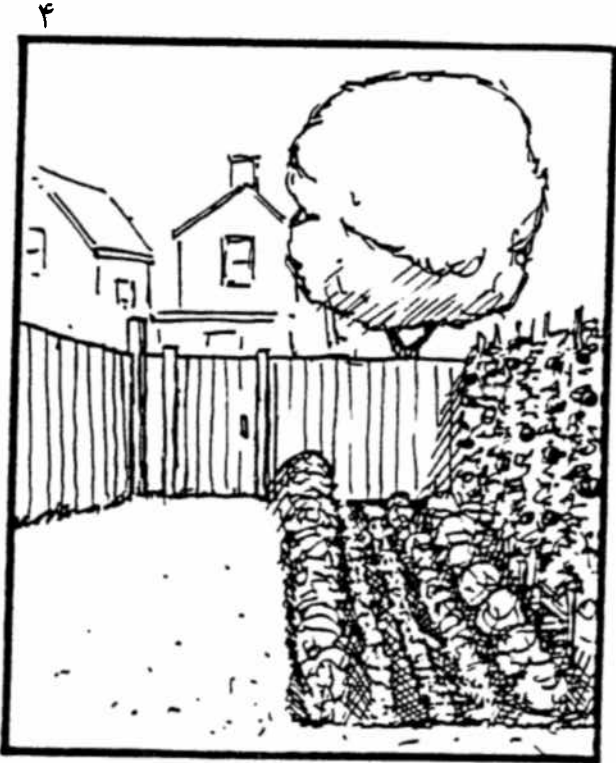
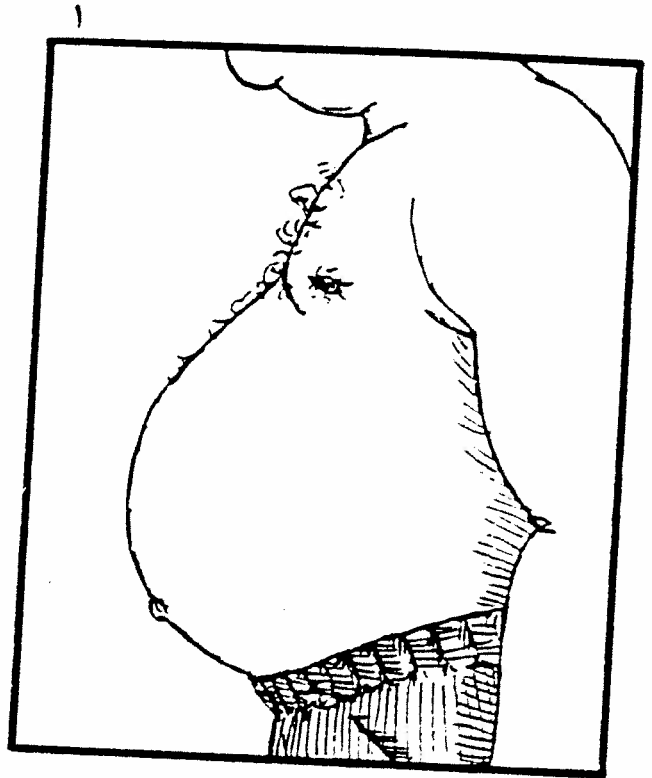
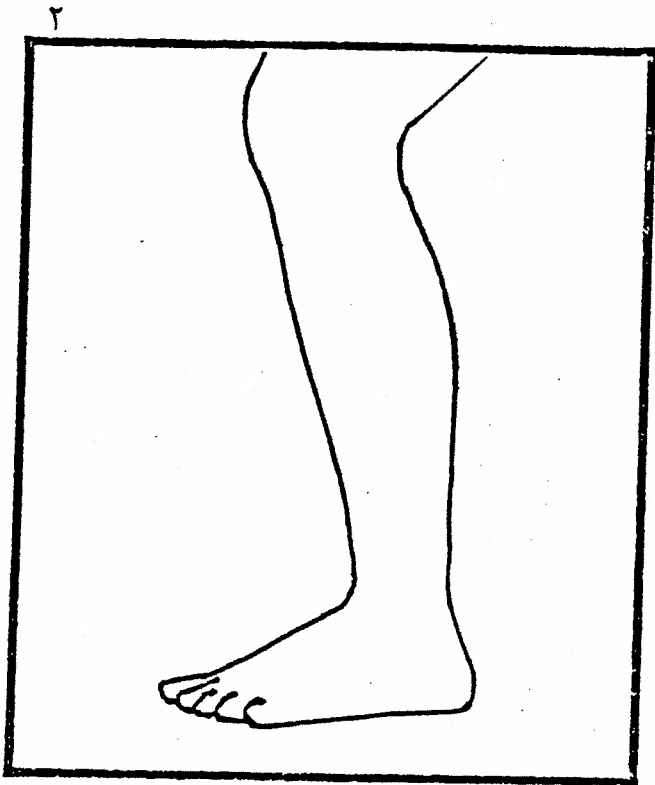

F10

چاق

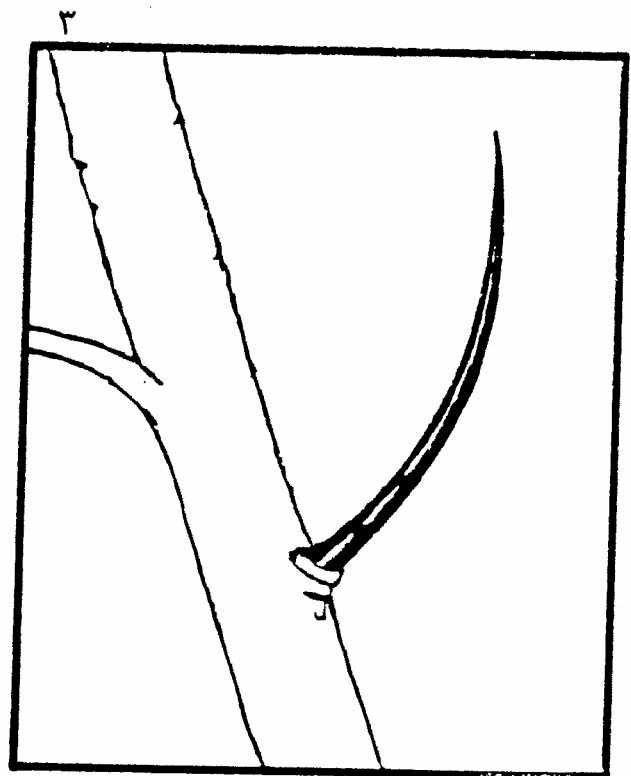
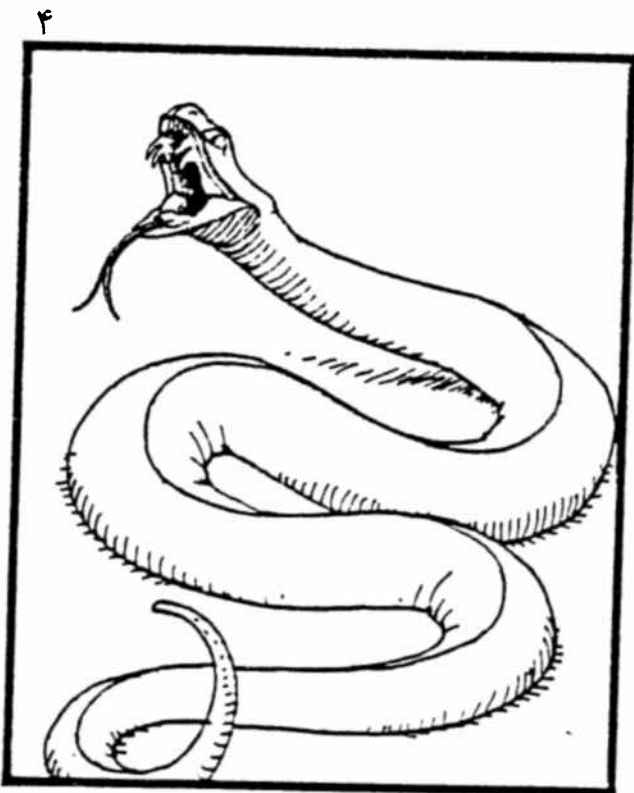
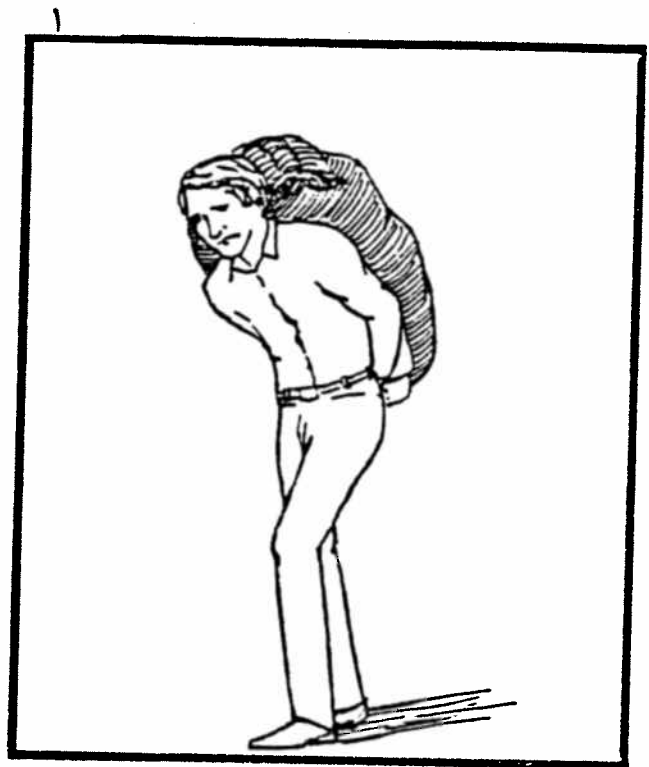
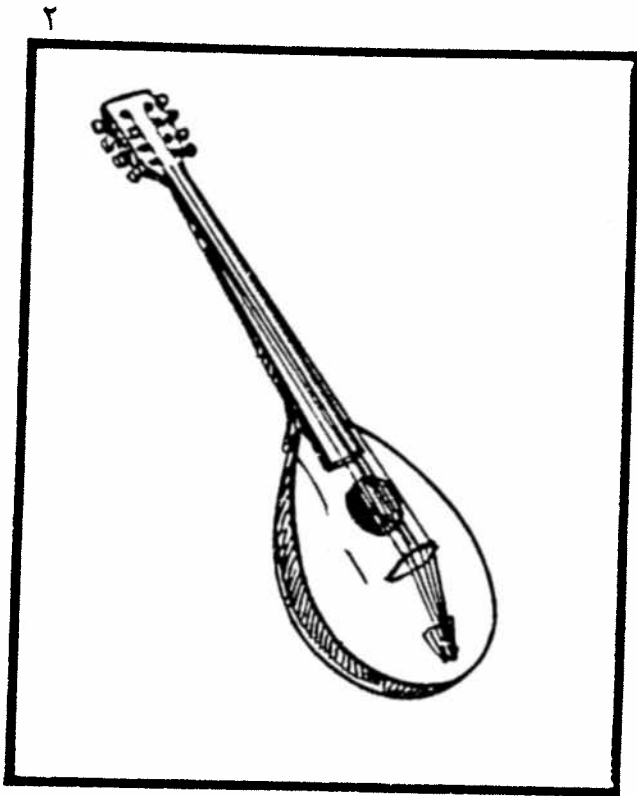

بار

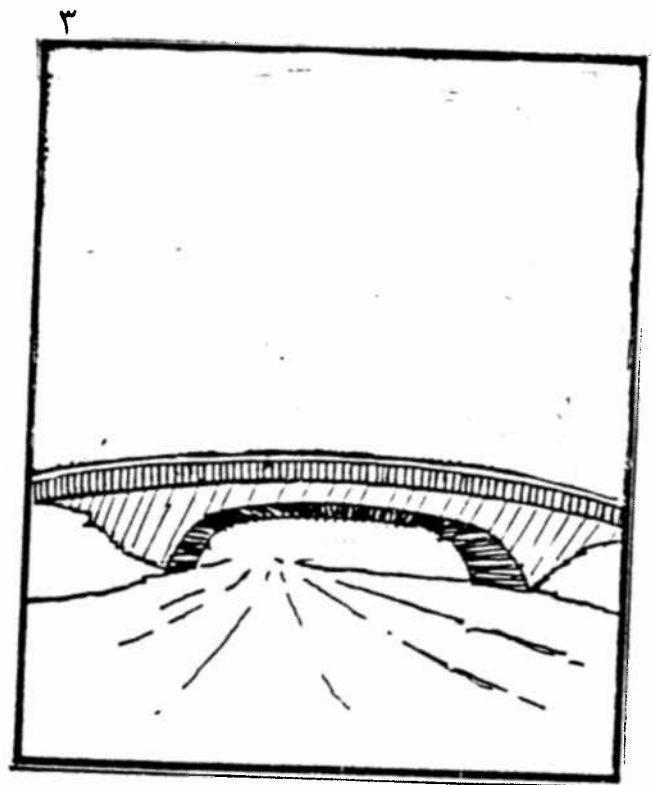
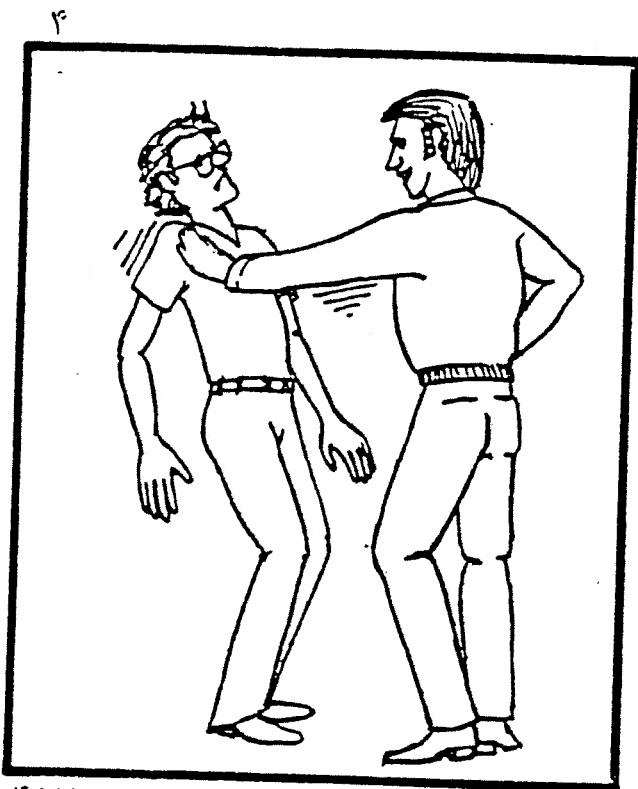
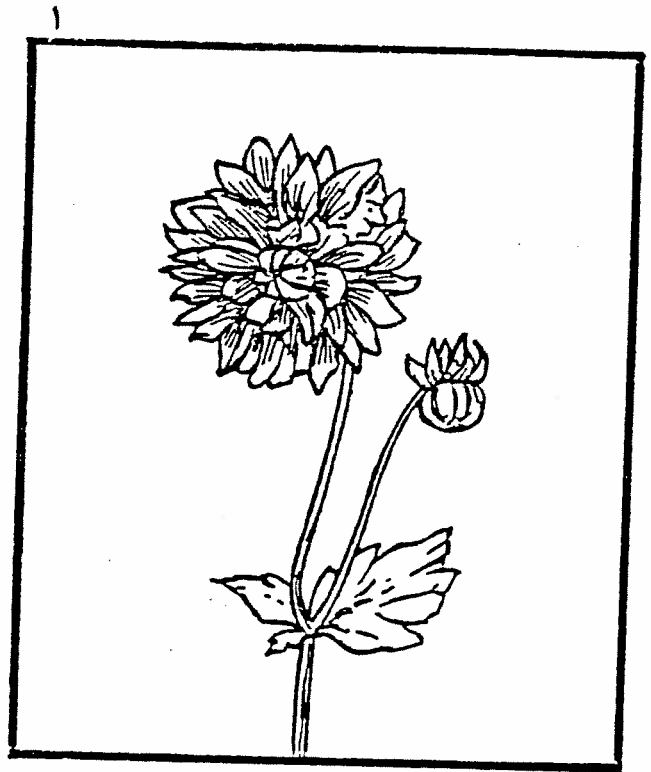

فہم



تصویرهای بخش درک خواندن جمله ها

2

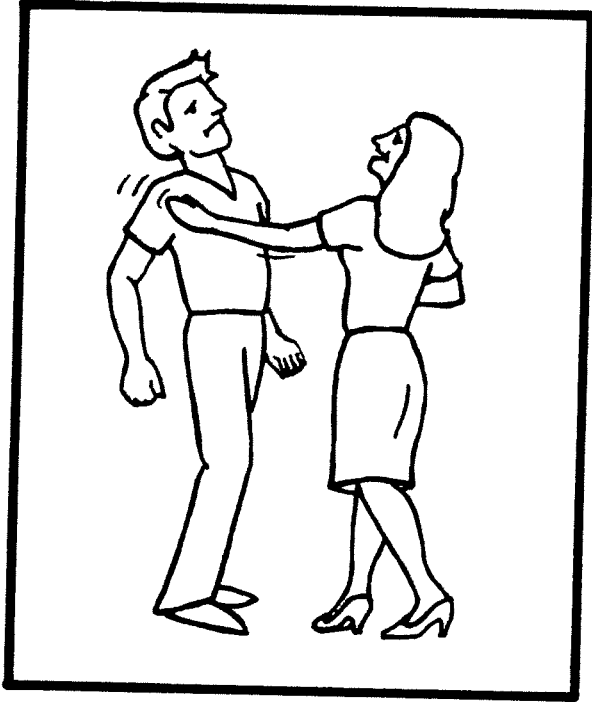

1

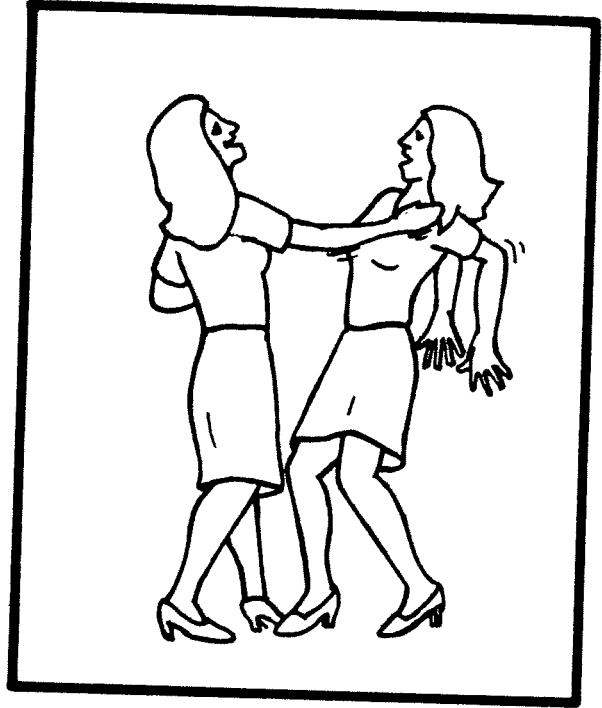

4

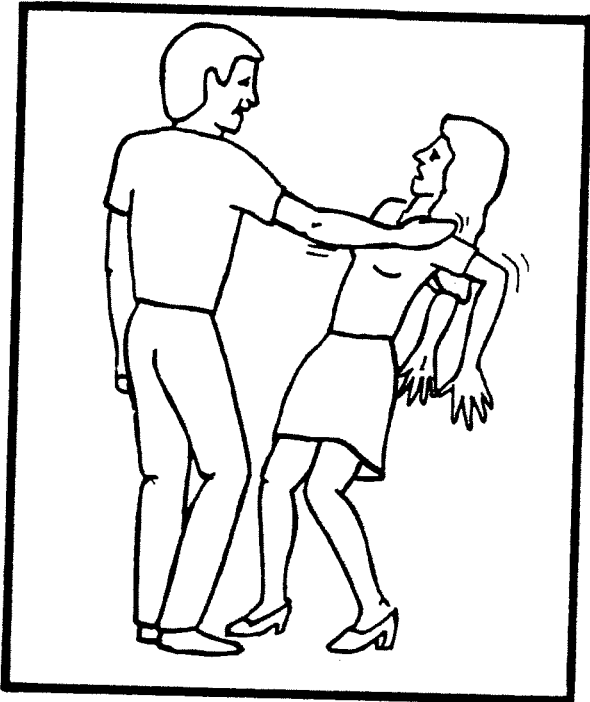

3

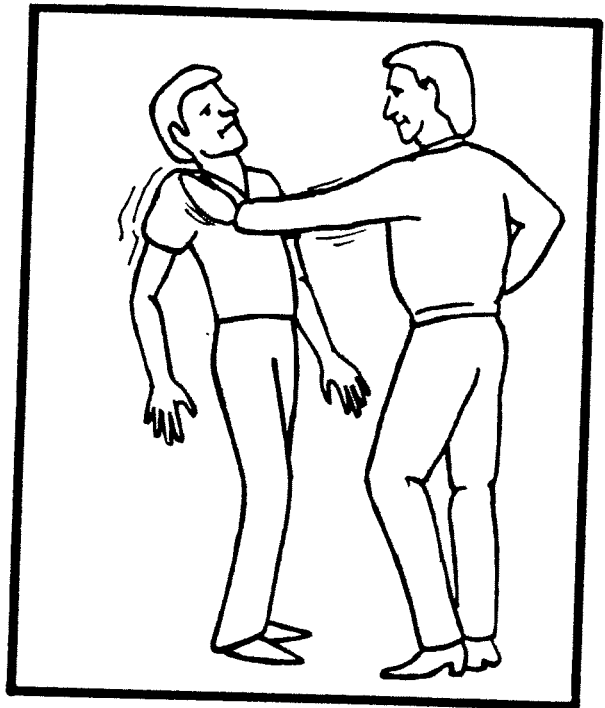

F1A

دختر پسر را هل می دهد

2



1



4



3



پدر به خودش نگاه می‌کند

1

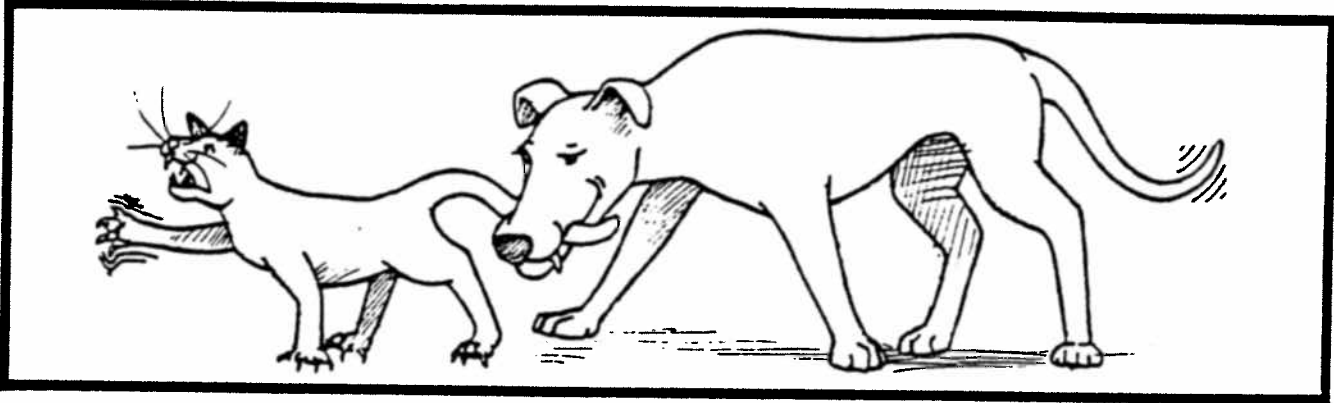

2

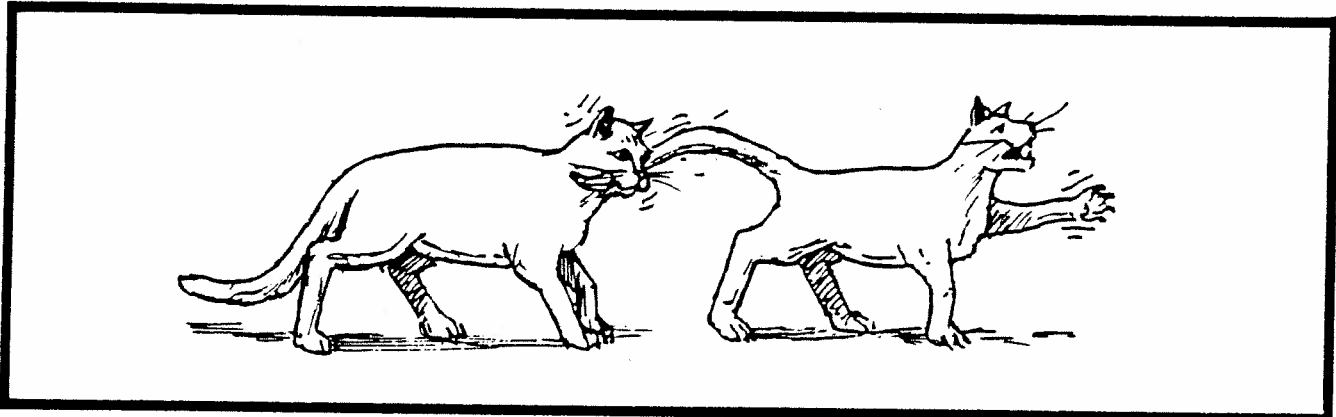

3

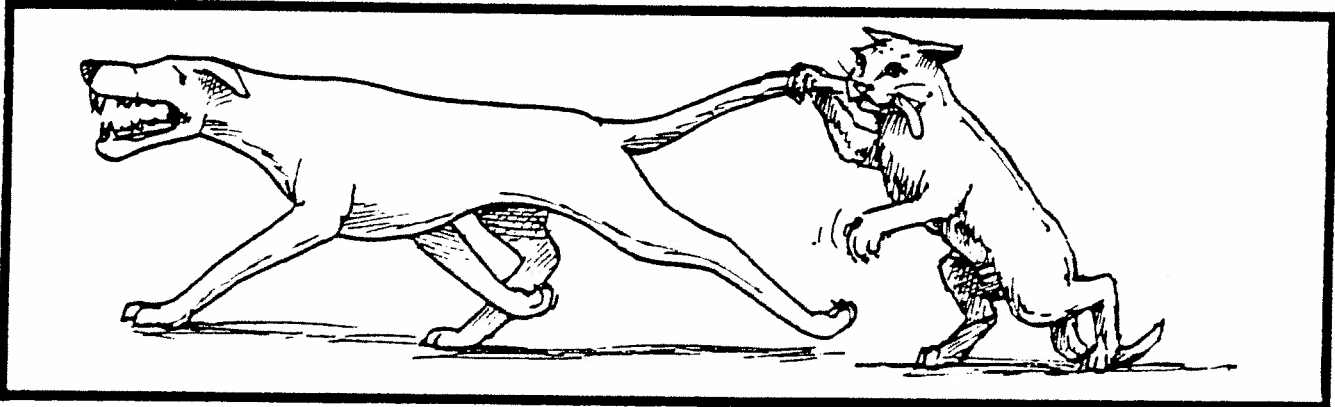

4

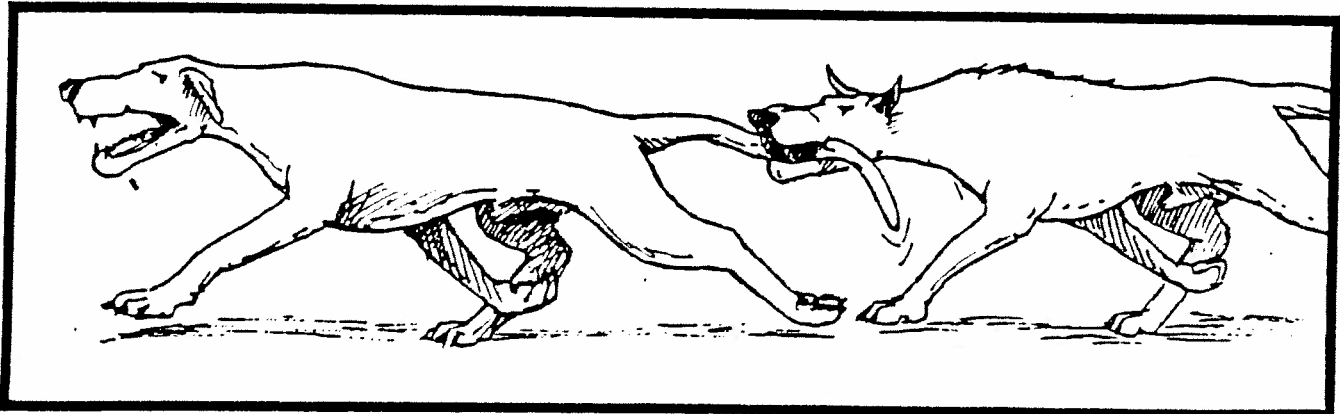

سگ را گربه گاز می‌گیرد .

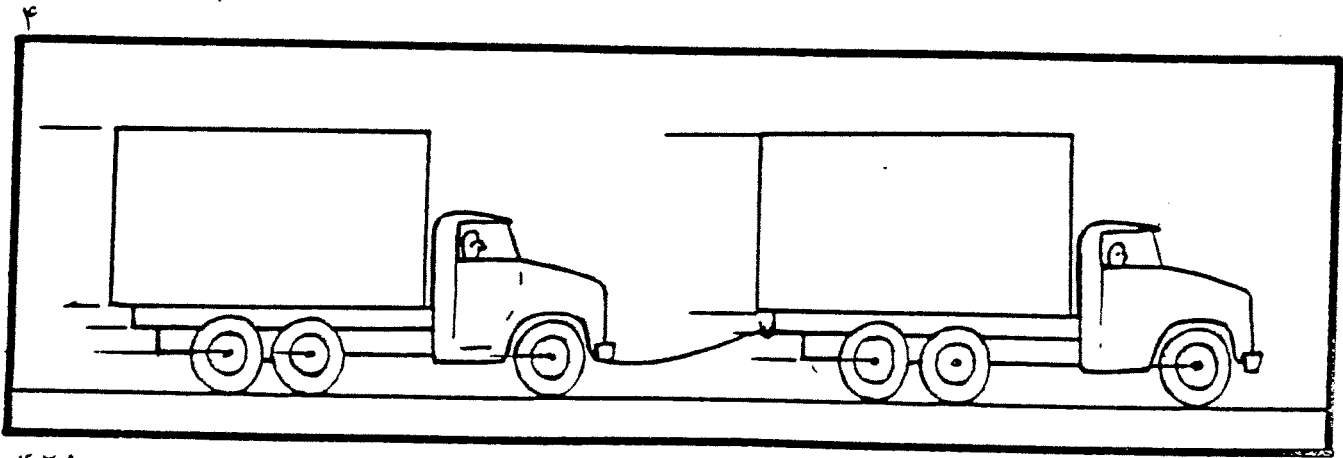
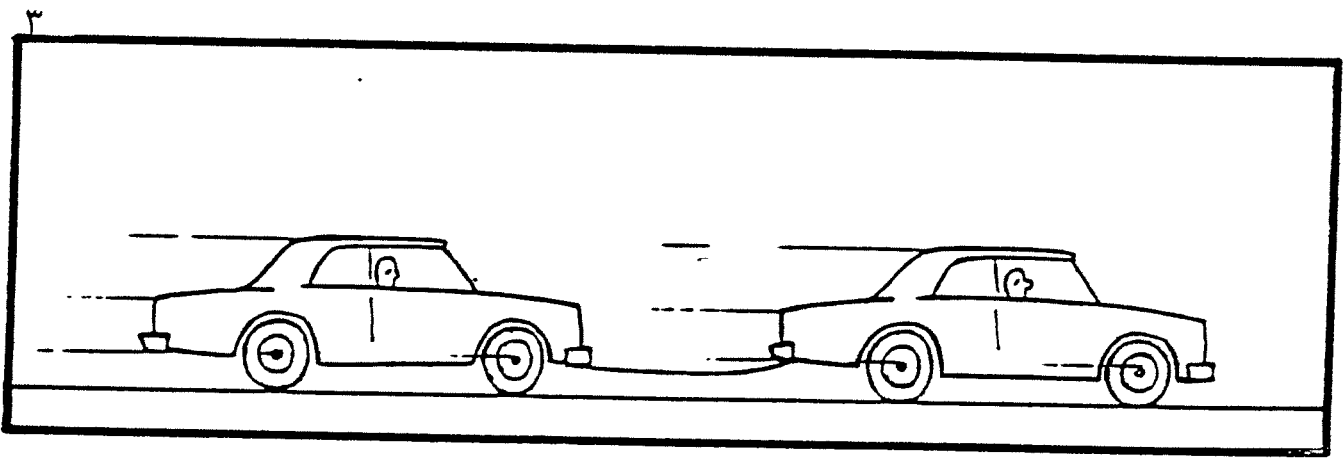
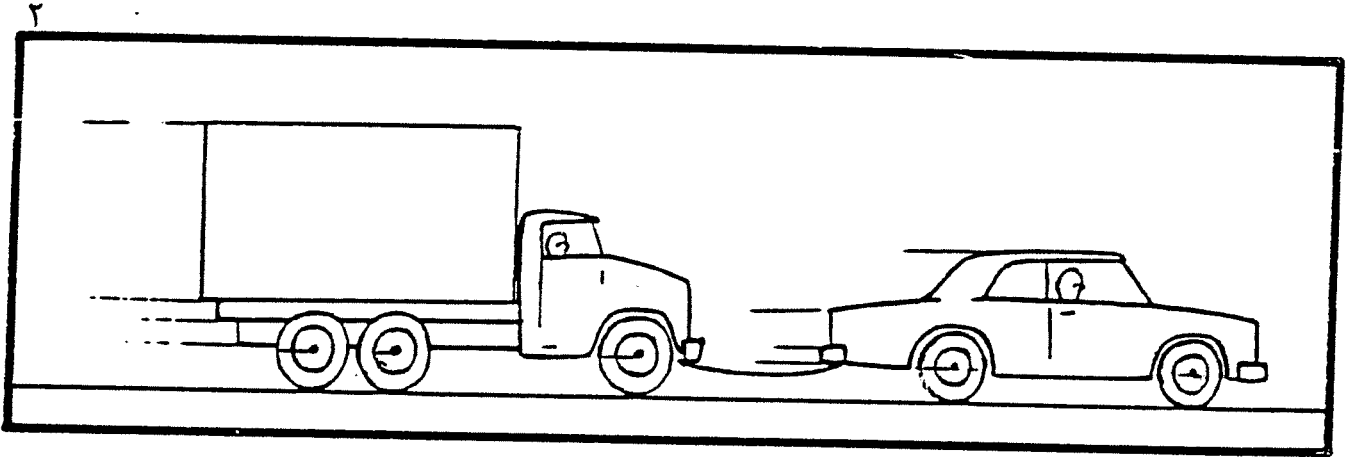
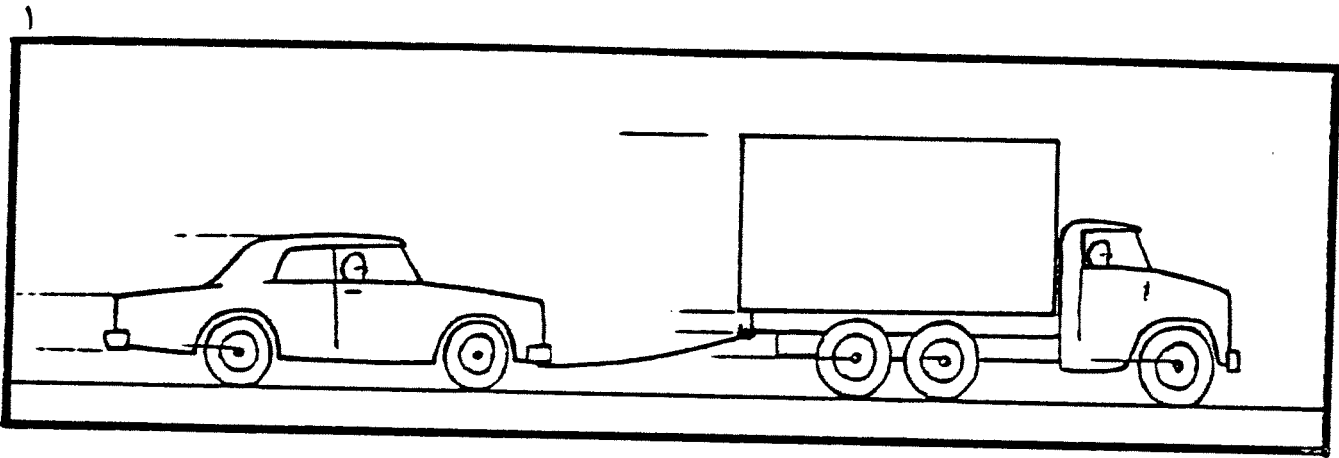

این کامیون است که سواری را می کشد



زن آن مرد را نمی‌بوسد .

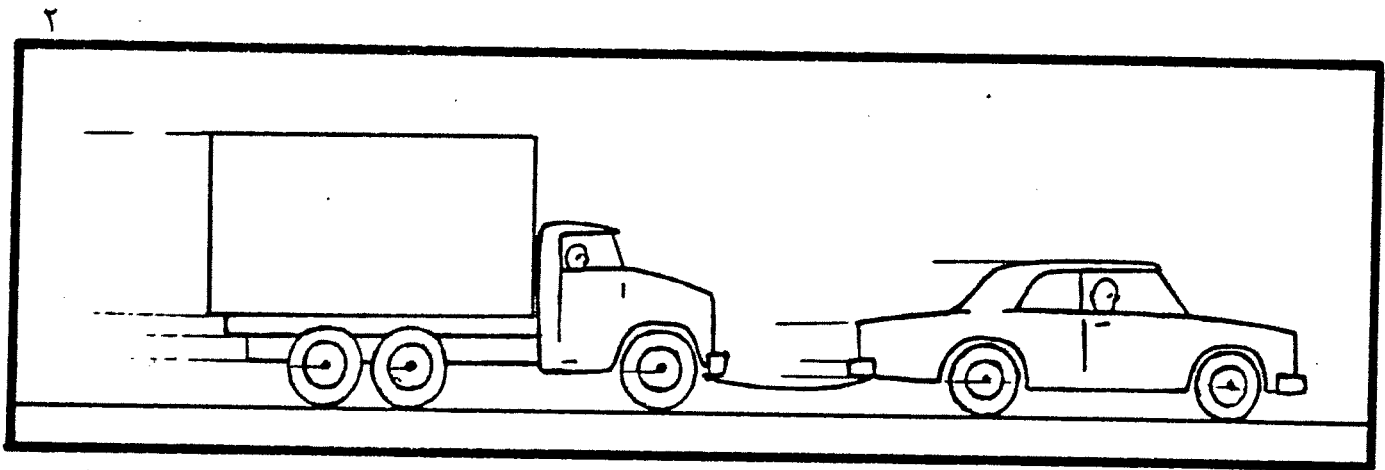
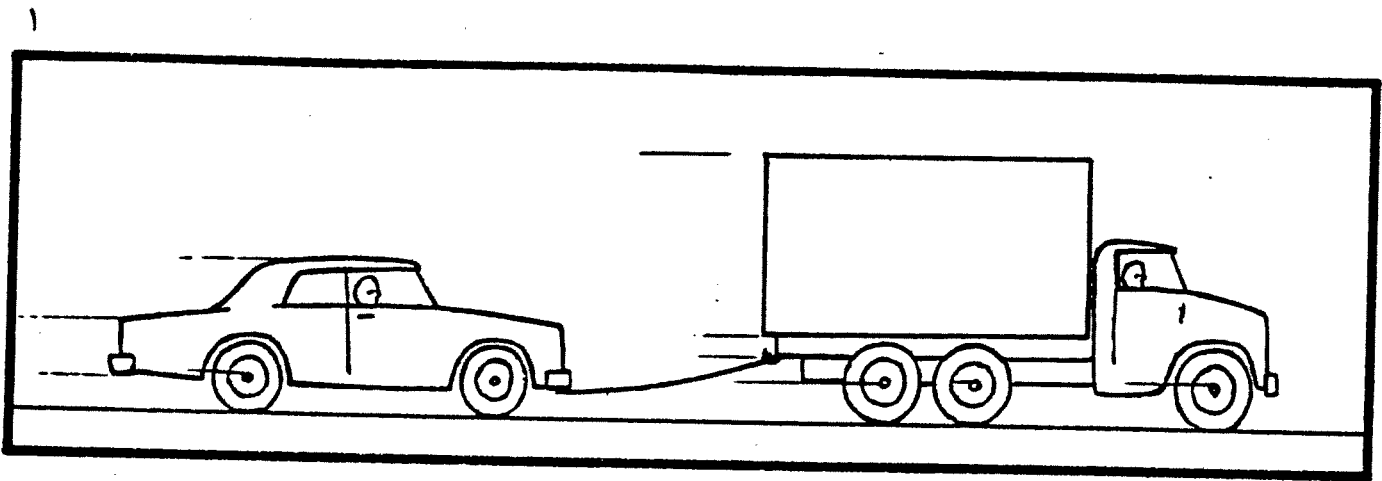

۴۲۲

کامیون را سواری نمی‌کشد .

1

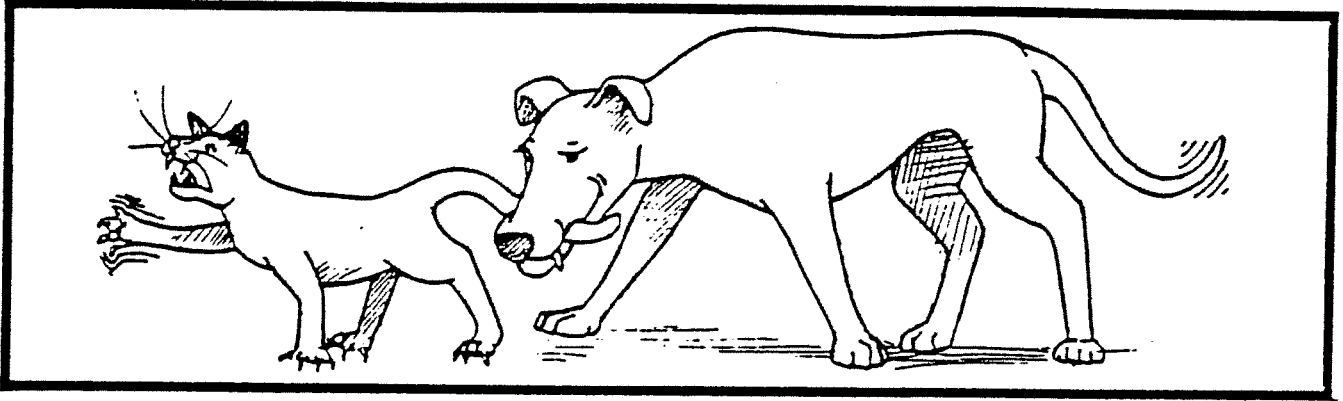

2

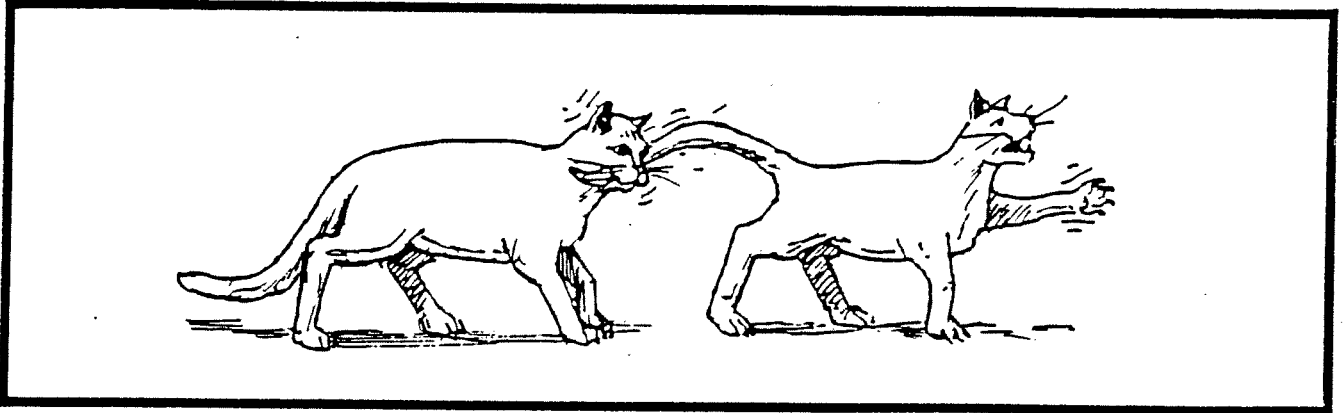

3

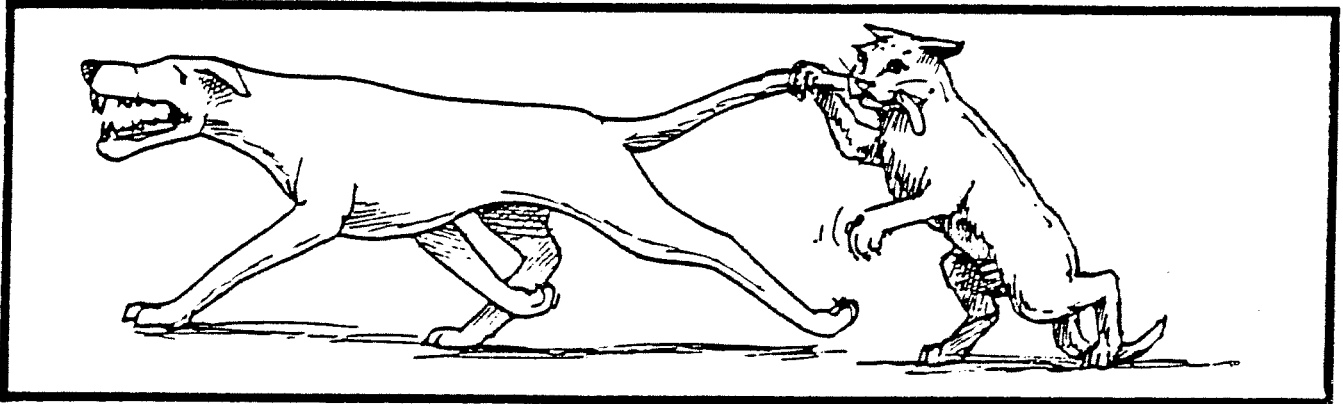

4

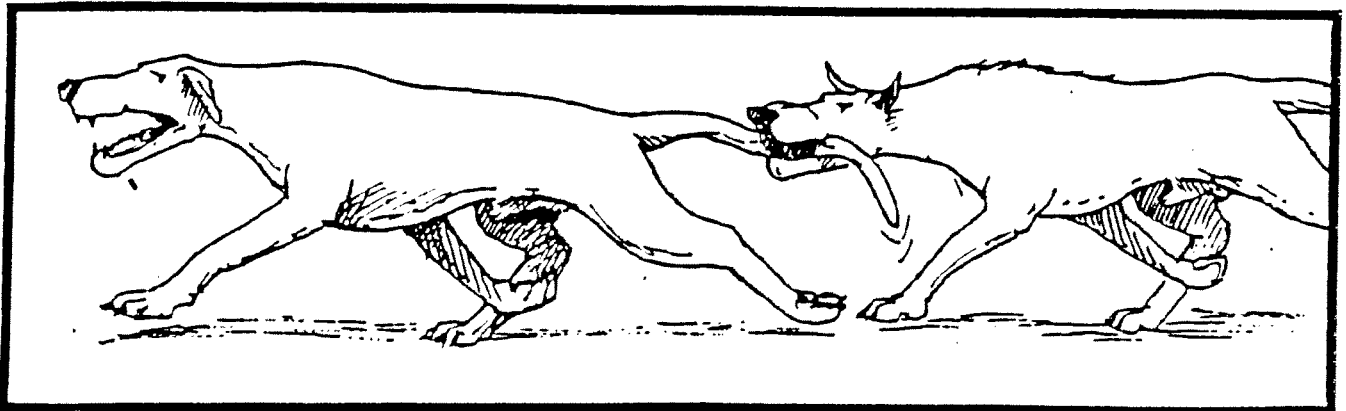

این سگ است که گربه گازش می‌گیرد

2



1



4



3



FTD

آنها دنبال او می‌دوند .

۲



۱

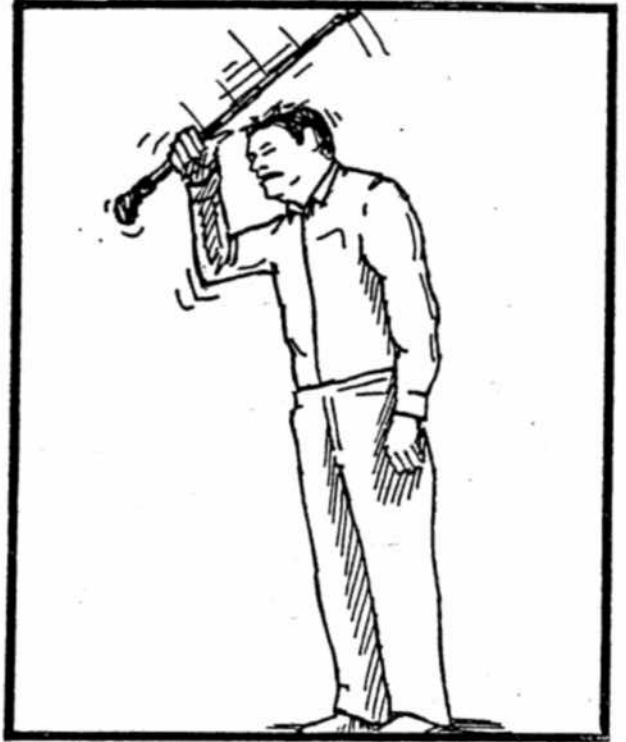

۴



۲



خودش را آن زن میزند .

1

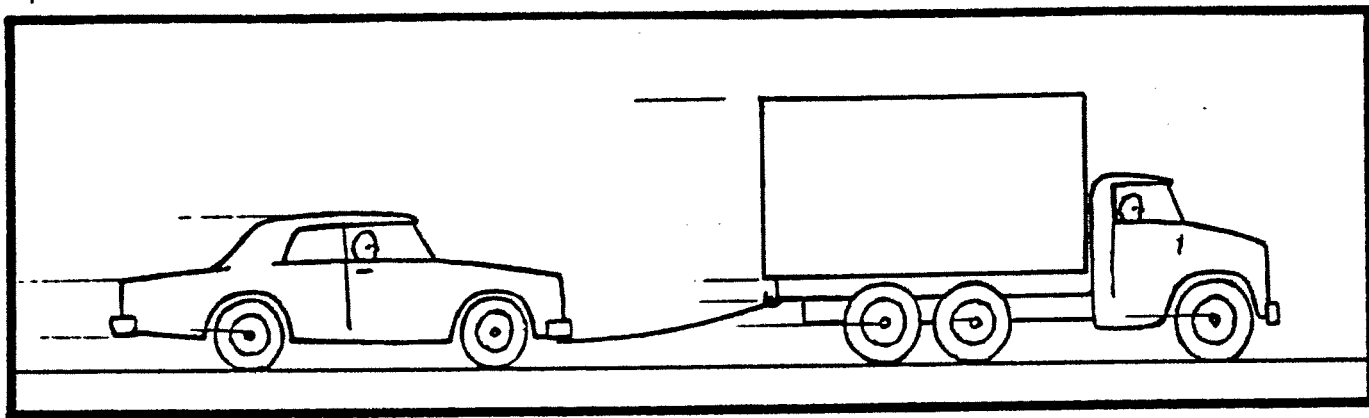

2

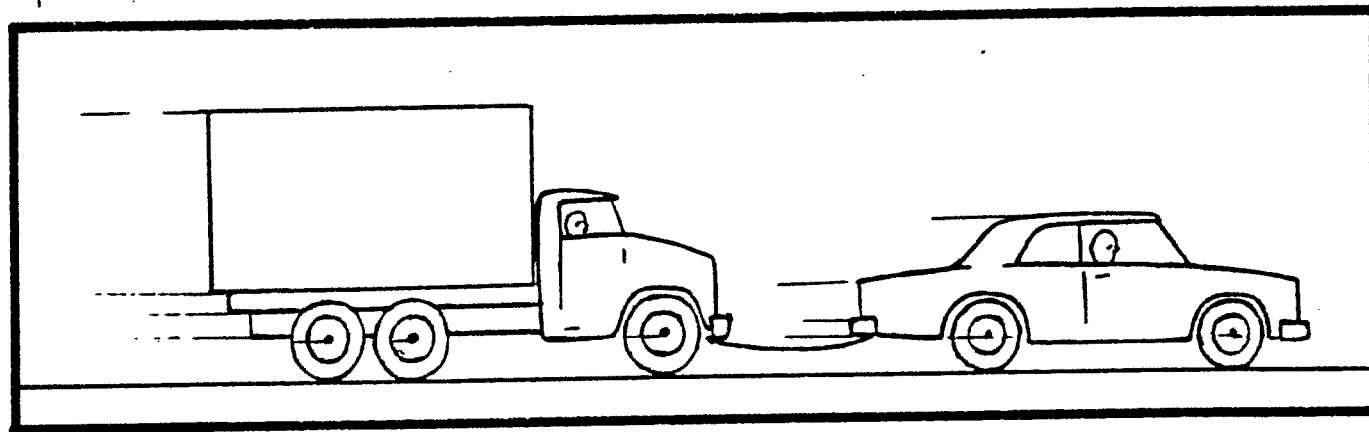

F2Y

سواری را کامیون نمی‌کشد .