

SELECTING STEAM TURBINES FOR PUMP DRIVES

by

Michael A. Cerce

Market Manager, Industrial Steam Turbines

Elliott Company

Jeannette, Pennsylvania

and

Vinod P. Patel

Senior Principal Machinery Engineer

Halliburton-KBR

Houston, Texas



Michael A. (Mike) Cerce is the Market Manager, Industrial Steam Turbines, for Elliott Company, in Jeannette, Pennsylvania. During his 36 plus year career with Elliott Company, he has had a variety of positions in Marketing and Application Engineering on steam turbines and compressors, plus eight years as Senior Business Analyst/Strategic Planning.

Mr. Cerce graduated (Mechanical Engineering, 1966) from Case Institute of

Technology.



Vinod P. Patel is a Senior Principal Machinery Engineer, Machinery Technology, for Halliburton-KBR, in Houston, Texas. He has been with Halliburton-KBR for 27 years. In his current assignment, he is responsible in the preparation and auditing of specifications, equipment evaluation, engineering coordination, and testing and installation startup of rotating and special equipment. He has worked in the various application of rotating

machinery in the petrochemical and refinery processes including ammonia, LNG, olefins, cat-cracking, and hydrotreating for domestic and international projects.

Mr. Patel received B.S. and M.S. degrees (Mechanical and Metallurgical Engineering) from Maharaja Sayajirao University of Baroda, India, and Youngstown University, respectively. He is a registered Professional Engineer in the State of Texas.

ABSTRACT

Selecting the right steam turbine for the application can save the purchaser money on initial cost (avoiding oversizing) as well as operating costs (better efficiency). The intent of this paper is to provide steam turbine basics, and to provide the purchaser with information needed to make the right choice. The emphasis is on a discussion of the parameters needed for the selection, and how they affect the turbine offering.

INTRODUCTION

Before getting to the selection basics, let us answer some fundamental questions and review typical construction for small steam turbines.

Where Are Steam Turbines Used?

Steam turbines are applied in a wide variety of industries to drive pumps, compressors, generators, and other rotating equipment, usually in a facility where steam is available for other reasons.

Why Are Steam Turbines Used?

Steam turbines are used as an alternative to other drivers in industries where steam is available and where the advantages of steam turbines are an asset:

- *Variable speed drives*—Turbines are capable of operating over a fairly wide speed range, normally 5 percent above design speed and 20 percent below. This is important in duties such as pump, fan, and compressor drives where the driven equipment output demand varies with speed. In some applications such as paper machines, a turbine needs to operate over a much wider speed range—as high as a 10 to 1 ratio. Turbine controls can achieve these wide speed ranges and hence are often preferred over other drivers.

- *Quick starting*—Steam turbines can be started quickly and can readily be operated in a standby mode. In many hydrocarbon plants two parallel pumps are supplied that are suitable for a single duty—a main pump and a backup should the main pump experience an emergency shutdown. The main pump might be a motor (or steam turbine) drive and the auxiliary pump will have a steam turbine driver as a quick starting backup.

- *Steam balance*—In some process plants the steam is generated by the process and is needed at different pressure levels throughout the plant. Steam turbines can be used as an alternative to a pressure-reducing valve to balance out the flow of steam at the different pressures. In some cases the steam can be used to drive a generator, and the electric power can be used for motors.

- *Steam availability*—Industries where steam is available include plants where the process is exothermic and this energy is used to generate steam. Examples include many hydrocarbon processing plants such as refineries, ethylene plants, ammonia, and methanol plants. Waste heat recovered from a gas turbine exhaust can also be used to generate steam.

Other industries where steam is available are those that need steam for the process. Examples include paper mills, facilities that use steam for area heating (universities), and air-conditioning (many large cities). In addition, industries that have a combustible by-product that can be readily burned to create steam (sugar mills and palm oil mills) are examples of steam turbine users who can use waste product to create steam and use turbines to provide process equipment with power. This typically occurs because the

mills are installed in remote locations where reliable electrical power is not available. Hence, burning by-product to make steam provides a way to self-generate electricity as well as provide process equipment with useful power.

• *Electrical power not required*—When the electrical power is out, a steam turbine can keep critical duties operating.

• *Flexibility*—Steam turbines can be used on a variety of duties with common spare parts and can usually be upgraded in power with minimal expense.

Turbine Construction

The cross section in Figure 1 shows typical construction for a single-stage steam turbine, and identifies the major components. For typical materials of construction, refer to APPENDIX A.

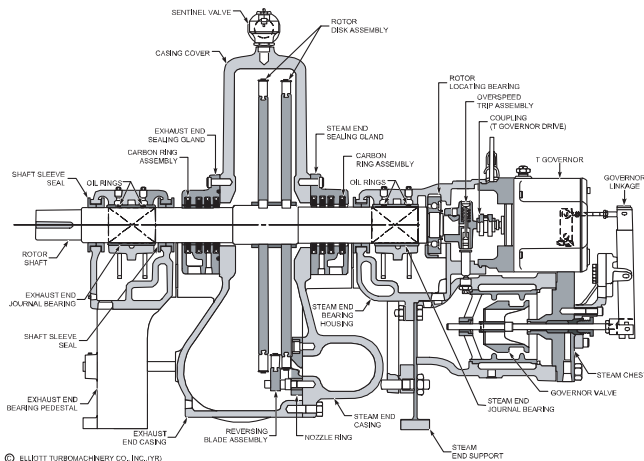

Figure 1. Cross Section of Typical Single-Stage Steam Turbine.

Casings and Steam Path

Steam enters the inlet flange into the steam chest (Figure 2). The steam chest contains two key components—a trip or stop valve to protect the turbine from overspeeding, and a governor valve that controls the turbine speed (Figure 3). These two functions must be separate, even if they are housed in one body.

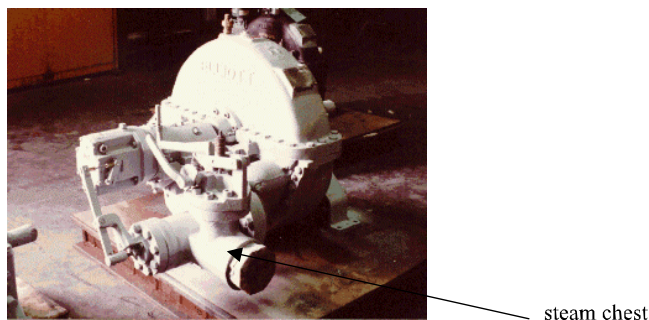

Figure 2. View from Inlet Side of Turbine.

From the steam chest, the steam enters the steam end (Figure 4) where there is typically a “main bank” of nozzles and hand valves to allow exposing more nozzles when higher power and steam flows are needed. The nozzles accelerate the steam to high velocity, directing the steam to the blades mounted on the rotor. The velocity energy is converted to mechanical energy, causing the shaft to rotate.

The stage illustrated is a velocity compounded “Curtis” type impulse stage. In a Curtis stage the pressure drop is taken across the nozzles, producing minimal thrust on the rotor. A Curtis stage

OVERSPEED TRIP AND GOVERNOR VALVE

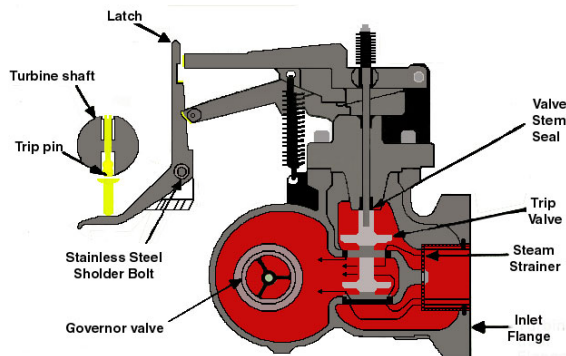

Figure 3. Illustration of Typical Steam Chest.

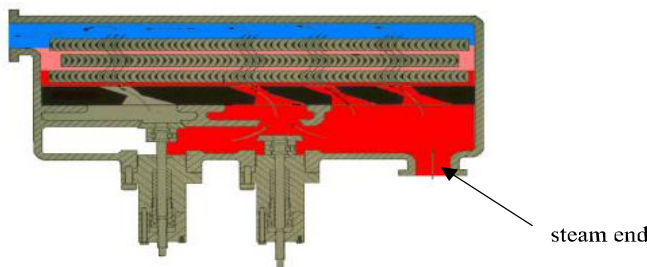

Figure 4. Illustration of Turbine Steam End and Hand Valve Ports.

is used because its characteristics allow a wide range of operation with a “flutter” performance curve than alternative staging. In a Curtis stage, the steam flow exiting the first rotating row of blades has to have its direction reversed to enter the second row, where more energy is converted to work. For more on types of staging, refer to APPENDIX B.

The nozzle throat diameters are chosen to match the pressure ratio across the stage. If these are not matched properly, the nozzle may operate very inefficiently.

One reason a steam turbine can be readily upgraded is the ease of replacing the nozzle ring. In a simple case an extra 20 percent power can be achieved with 20 percent more nozzles. This is not always possible, but in the worst case, the nozzle ring, disks, reversing buckets, and maybe the steam chest will have to be replaced.

Once the steam leaves the second row, it exits through the turbine exhaust flange (Figure 5). Note that the casing centerline is supported with a pedestal on the driven machine end and a wobble foot on the steam end (Figure 6). This allows growth of the turbine away from the centerline radially, and away from the driven machine axially.

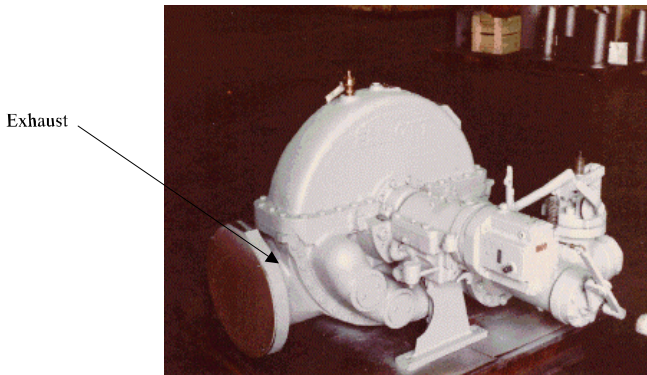
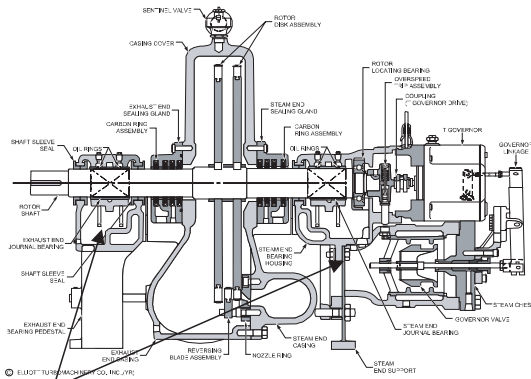

Figure 5. View from Exhaust End of Steam Turbine.



Centerline support

Figure 6. Cross Section Showing Casing Support.

Rotor and Rotor Support

The rotor, in small turbines, usually has a standard configuration as a function of the turbine frame. The shaft diameters, shaft end sizes, bearing span, etc., are always the same. The blades are mounted on the disk(s) using tee-shaped or pine tree-shaped slots. The blades usually have a shroud band(s) with a peened tang to tie them together and reduce excitation (Figure 7). The disks are shrink-fit and keyed on the shaft.

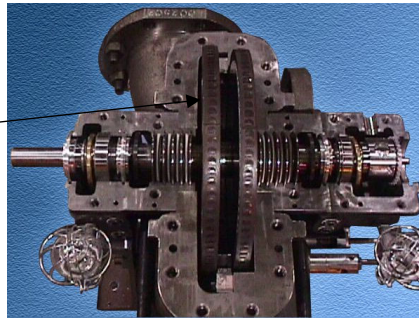

Figure 7. Photo of Small Turbine with Cover Removed Showing Rotor.

The rotor is supported with sleeve or antifriction journal bearings that are normally ring-oiled (Figure 8). Passages in the bearing housings circulate cooling water to keep oil temperatures down (Figure 9).

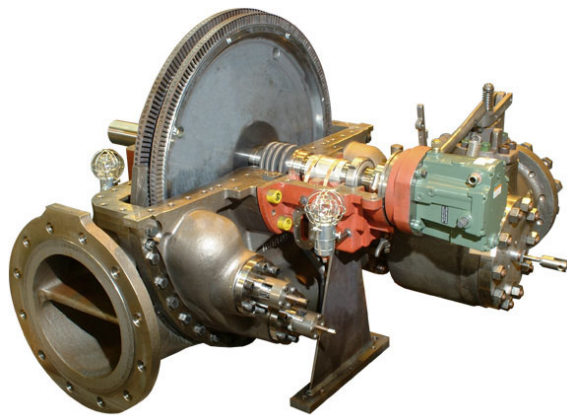

Figure 8. Turbine with Cover Removed.

There are several items that can require the turbine be pressure lubricated:

- Speeds in excess of 5000 rpm. Oil rings just are not as effective above this speed.

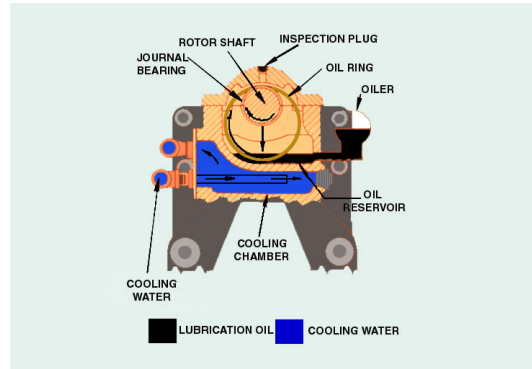

Figure 9. Ring-Oiled Lubrication.

- A tilt-pad thrust bearing is needed. A tilt-pad thrust bearing can be a turbine requirement for higher power turbines with higher thrust, or it can be a customer-specified requirement.
- High exhaust temperatures. The steam temperature at the exhaust is also the temperature a few inches away from the bearing housing. Depending on the heat transfer for shaft and water-cooling, the high shaft temperature can cause the oil to coke.
- If a trip and throttle valve is specified or required. Most are oil actuated, and hence a lube system is needed anyway.
- If there is a gear in the string, it has to be pressure lubricated. The added cost of pressure lubricating the turbine is minimal, typically interconnecting oil header and drain piping between the turbine and the lube system.

Shaft Seals

Small turbines generally use carbon rings to seal the shaft and prevent steam leakage to atmosphere. At higher pressures, a combination labyrinth/carbon ring arrangement may be used, requiring the customer to connect an intermediate leak-off connection to a suitable header in the plant (Figure 10).

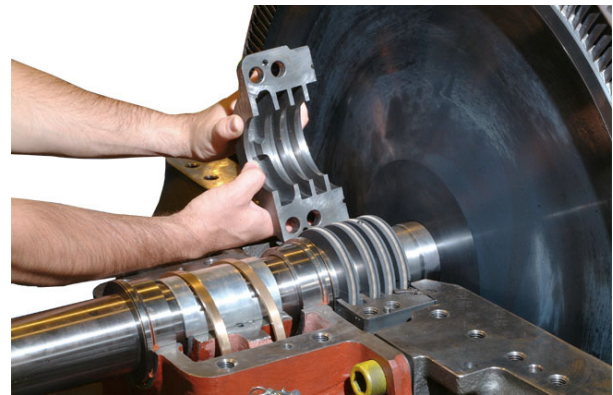

Figure 10. Carbon Ring Seal Arrangement.

One of the common complaints about steam turbines is steam leakage getting through the shaft seals (often carbon rings) and bearing housing seals and getting into the oil. A number of solutions are available—all with some degree of upside and downside.

One solution is to use an ejector or eductor to draw a vacuum at the leak-off connection pulling the steam and air down and out of the packing case. This approach adds cost and steam or water usage, but works well.

A second choice is to seal the steam more positively. Gas seals adapted for gas compressor applications have been used for this purpose. The success of these seals is highly dependent on having high quality steam, no liquids—including at startup—and

allowance for the growth that occurs from the high turbine operating temperatures.

Another choice is to seal the bearing housing more positively so steam cannot enter. A number of companies provide “bearing isolators” adapted from pump designs that provide a better shaft seal at the bearing housing. Successfully applying these seals to turbines must consider turbine operating temperatures and associated growth, turbine speed, space, and mechanical fit of the seals in the turbine bearing housing, and, in some cases, adapting the seal for pressure lubricated applications.

Controls

The turbine speed is controlled by a governor (Figure 11). For simple turbines, a mechanical/hydraulic governor is mounted on the rotor. Internal to the governor is a speed sensor (flyweights), a comparison to the speed set point is made, and a servomotor supplies the power necessary to position the governor valve to allow just enough steam to maintain the speed set point. With electronic governors, the speed sensing is usually a magnetic pickup (MPU), the flyweights are replaced by electronics, and the correction is done with an actuator mounted to the governor valve.

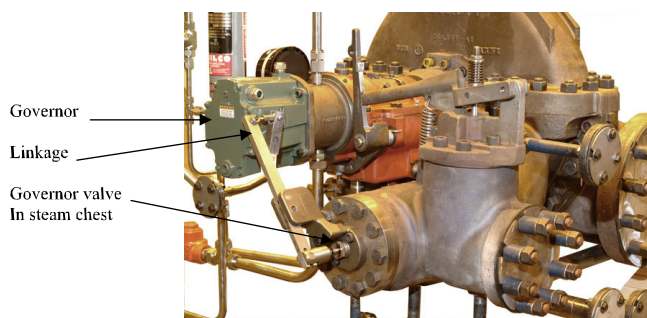

Figure 11. Turbine Controls.

The National Electric Manufacturers Association (NEMA) Standard SM-23 (1991) has established control definitions for governors based on the requirements on speed range, speed regulation, speed variation, and speed rise (Table 1). Today, NEMA A and NEMA D are by far the most commonly specified classifications for either electronic or mechanical hydraulic governors.

Table 1. NEMA Governor Control Definitions.

NEMA Class	Adjustable Speed Range %	Speed Regulation % *	Speed Variation % **	Speed Rise % ***
A	10 through 65	10	0.75	13
B	10 thru 80	6	0.5	10
C	10 thru 80	4	0.25	7
D	10 thru 90	0.5	0.25	7

* Speed regulation is defined as the change in speed when the power output of the turbine is gradually reduced from rated output to zero output.

** Speed variation is defined as the total magnitude of speed change or fluctuation from the set speed.

*** Speed rise is the ability of the governor to catch the speed increase when the output power is reduced from full load to no load instantaneously.

Specifications

NEMA SM-23 (1991) is widely regarded as a basic turbine specification and much of its content is referred to by other basic specs. In particular, NEMA specifications are used for turbine control definition and allowable steam piping loads.

API Standard 611, Fourth Edition (1997), “General-Purpose Steam Turbines for Petroleum, Chemical, and Gas Industry Services,” is the most common requirement for HPI/API users. The API specification is more stringent than NEMA, but properly reflects the needs of this customer base. The specification upgrades are generally minor, but include such items as steel covers on casing openings for shipment, piping standards, material standards, rotordynamics, and a one hour mechanical no-load test (instead of

½ hour). Typically duties in an HPI facility would include pump and fan drives. The specification is also applied to other noncritical duties such as plant air compressors and generator drives that are typical in the utility locations. Compliance with API 611 (1997) can add 5 percent to 50 percent to the price of a turbine designed to manufacturer’s standards.

API Standard 612, Fourth Edition (1995), “Special-Purpose Steam Turbines for Petroleum, Chemical, and Gas Industry Services,” is the most stringent standardized specification. These are used to drive process compressors that are the heart of a process plant operation. API 612 (1995) adds significantly to the cost—two to 10 times premium. Construction changes include mandatory extras such as steel bearing housings, thrust bearings with minimum specified loads, integral rotor forgings in most applications, material testing and documentation, more extensive testing with tighter test tolerances for things like vibration, trip and throttle valves with hydraulic actuators, electronic governors and electronic overspeed devices, stainless steel header and drain oil piping, a four hour mechanical test, etc.

API 612 (1995) applications are usually higher power and therefore usually are multistage turbines to minimize steam usage.

DATA REQUIRED FOR SELECTING A STEAM TURBINE

Selection of the right turbine for a given duty requires certain specific information from the customer. The power needed by the driven machine and the speed at which the power is needed are essential. It is common for the customer to specify a design or normal point and then specify a higher power and speed capability, should the driven equipment need to be operated at higher capacities. This can be as much as 10 percent higher than normal power.

Other data needed to select the turbine are the steam conditions. The steam pressure and temperature at the turbine inlet flange are required, as well as the pressure at the turbine exhaust flange. This defines the energy available in the steam to do work.

While the above items are mandatory to do the selection, other information is also desirable:

- *Driven equipment*—In most cases the driven equipment dictates certain accessories. Examples of this are governor choices, whether gearing is needed or appropriate, and governor speed range.
- *Type of governor*—The control standard required by the driven equipment may dictate the type of governor that should be used. For example, packaged plant air compressors usually require NEMA D control with a very small speed range.
- *Special operation considerations*—Some applications require bill of material adders that should be part of the base bid. An example is auto-startup.
- *Relative importance of steam consumption or the cost of steam used in the bid evaluation process*—The steam turbine vendor will invariably offer the least expensive turbine that will meet the duty requirements. Usually, a more efficient offering is available at a higher price and may be a better offering from an operating cost perspective.

Steam Rate or Usage

Steam usage is usually measured in the amount of weight flow per unit time to develop the specified power with the specified steam conditions. Steam rate is expressed as pounds per horsepower hour (lb/hp-hr), or kilograms per kilowatt hour (kg/kW-hr).

In general, the more energy available in the steam, the less flow that is necessary to generate a specified power. The energy available can be obtained from a Mollier chart. It can also be determined from a publication, *ASME Publication of Theoretical*

Steam Rate Tables (1969). Theoretical steam rate (TSR) identifies the amount of flow that would be needed if the turbine were 100 percent efficient. This is not possible of course, especially for lower power turbines. While efficiencies of large central station power plant steam turbines can approach 90 percent, a single-stage turbine peaks around 60 percent and efficiencies of less than 30 percent are not uncommon.

The relationship between power, energy, efficiency, and flow is as follows:

$$Power = \frac{(Flow)(\Delta H_{is})(\eta)}{2545} - HP \text{ losses} \quad (1)$$

In English units:

Power = Turbine power output

Flow = Turbine steam flow - lbs per hour

ΔH_{is} = Isentropic enthalpy drop, Btu per lb

η = Efficiency

The steam rate is:

$$SR = \frac{Flow}{hp} \text{ or } \frac{TSR}{\eta} \quad (2)$$

The efficiency of a single-stage turbine is determined from the stage characteristic. This is typically represented as a curve of efficiency versus “velocity ratio”—the ratio between the blade speed and the steam speed exiting the turbine nozzles (Figure 12).

$$U / C_o = \frac{\pi D \times N}{(2g_c J \Delta H_{is})^{1/2}} \quad (3)$$

where:

D = Wheel pitch diameter in inches

N = Operating speed (revolutions per minute)

ΔH_{is} = Energy available to the stage in Btu per lb

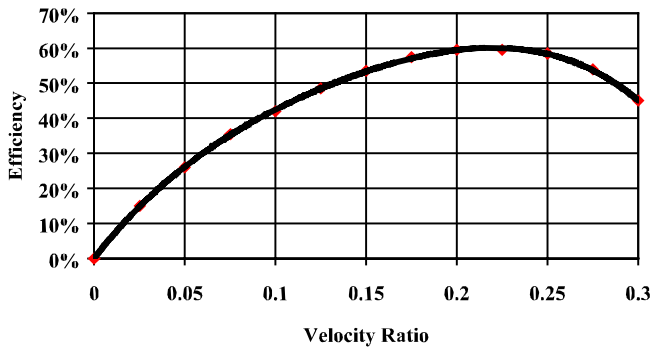

Figure 12. Typical Efficiency Curve for Single-Stage Turbine.

The diameter (D) of the wheel is specific to the turbine frame design, which varies by manufacturer. As an example, some single-stage turbines are offered in five diameters—12, 14, 18, 22, and 28 inches.

The turbine speed (N) is usually specified by the driven equipment, but sometimes a gear is recommended to optimize turbine efficiency or simply to operate at a reasonable speed for the turbine.

A sample—200 hp, 3600 rpm, 600 psig/650°F/25 psig TSR = 14.377 lb/kW-hr. Steam is valued at \$5.00/1000 lb. Available energy is 3413/14.377 = 237 Btu/lb; Choose a turbine with a 14 inch wheel. It is likely to be the least expensive turbine to meet the requirement. Velocity ratio = $\pi \times 14 \times 3600 / (2 \times 32 \times 778 \times 237)^{1/2}$ = .064, basic efficiency is approximately 30 percent. After corrections the steam rate is 38 lb/hp-hr.

Figure 13 is an illustration of the turbine efficiency on a Mollier chart.

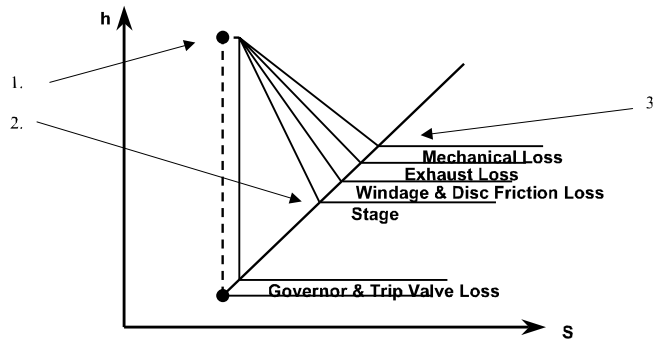

Figure 13. Mollier Chart Illustration.

- The very first thing that happens is throttling losses across the steam chest, trip, and governor valves.
- The stage efficiency determines the second point. Note that the basic efficiency is independent of power.
- Losses from windage, bearings, and exhaust hood establish the overall efficiency.

At \$5.00/1000 lb, the steam usage per year (assumed to be 8000 hours) would be:

$$38 \frac{lb}{hp-hr} \times 200 hp \times 8000 \frac{hrs}{yr} \times 5 \frac{\$}{1000 lb} = \$304,000 \text{ per year} \quad (4)$$

Assume the initial cost for this turbine is \$25,000. If the next largest frame is used, the initial cost might be \$35,000 and the steam rate would improve to 33 lb/hp-hr. At \$5.00/1000 lb, the steam usage per year (assumed to be 8000 hours) would be:

$$33 \frac{lb}{hp-hr} \times 200 hp \times 8000 \frac{hrs}{yr} \times 5 \frac{\$}{1000 lb} = \$264,000 \text{ per year} \quad (5)$$

So the added upfront cost of \$10,000 results in \$40,000 annual savings.

Similarly, the next largest frame would have a steam rate of 30 lb/hp-hr at a price of \$45,000. Annual operating cost is \$240,000. So the added upfront cost of \$20,000 produces a savings of \$64,000.

With the largest frame, the price would be \$55,000, and the steam rate would be 27 lb/hp-hr. Annual operating cost would be \$216,000. The added upfront cost of \$30,000 produces a savings of \$88,000.

Limit Checks

Once the steam rate is determined, there are a number of other factors to consider confirming that the selection is satisfactory.

- *Inlet size*—Several inlets may be available on a single-stage turbine frame. Steam velocity through the inlet is limited to 175 feet per second per NEMA SM-23 (1991).
- *Exhaust size*—Similarly, the exhaust size velocity has limitations. Exhaust steam velocities are limited to 250 feet per second for backpressure turbines, and 450 feet per second for condensing turbines per NEMA SM-23 (1991).
- Velocities can be determined from Equation (6).

$$Steam \text{ velocity} = V = \frac{0.04Gv}{A} \quad (6)$$

where:

G = Weight flow (lb/hr)

v = Specific volume (ft³/lb)

A = Area (in²)

- *Shaft torque*—Each frame has a given shaft diameter that can transmit only a specified power at a given speed. This can become a factor when the turbine is run at very low speeds (direct coupled to a 1500 rpm pump, for example).
- *Blade loading*—The velocity and the flow of the steam acting upon the rotating blades produce stresses in the blades. A Goodman diagram determines the allowable blade loading at the given conditions based on speed, blade mechanical design, materials, and temperature.
- *Blade resonance*—The steam hitting the blades can excite natural frequencies in the blades, leading to potential fatigue failures as the cyclic blade stress increases.
- *Bearing loadings*—The thrust developed by the staging must be absorbed by a thrust bearing. For the impulse type (Curtis) stages used in single-stage turbines, the thrust is usually nominal and can readily be absorbed by a ball type bearing. Double acting, self equalizing thrust bearings are available when required.
- *Speed limitations*—Blades, shrouds on blades, disks on which the blades are mounted, shaft upon which the disks are mounted, all have speed limitations. Each must be checked to assure all these limits as well as the critical speed for the rotor configuration is acceptable. For higher speeds, different blade roots, shroud arrangements, and integral rotors can be solutions when the standard design limitations are exceeded.
- *Nozzle limitations*—Each frame has a defined arrangement for nozzles depending upon nozzle height and type, number of nozzles of a given throat diameter (expansion ratio) required, hand valve locations, rotation, and availability. All these variations have to be evaluated for normal operating conditions as well as any off-design conditions. This discussion will continue later.

Use of Hand Valves

In many cases, the driven equipment will have a range of operating conditions specified, and the steam turbine needs to be capable of operating at all of them. In addition, the operating steam conditions for the turbine can vary. These factors can sometimes result in a turbine that is capable of much greater power than normal conditions dictate and lead to relatively inefficient operation at normal conditions. Hand valves on the turbine can help to address these alternate operating points (Figure 14). Hand valves are used to allow variations in operating conditions to be met without significantly affecting a design steam rate. This is an important factor and worthwhile to look at a recent, real example.

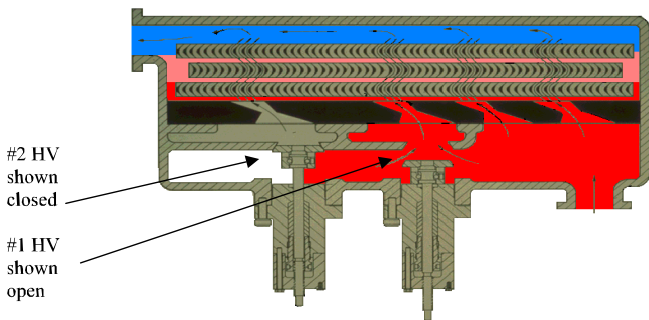

Figure 14. Hand Valve Illustration.

Example

Pump normal power and speed: 770 hp at 3600 rpm
 Normal steam conditions: 600 psig/700°F and 175 psig exhaust pressure

The specification required the turbine to be capable of an extra 10 percent power or 847 hp. In addition, the steam conditions have a tolerance as follows:

Minimum inlet conditions: 550 psig/650°F
 Maximum inlet conditions: 625 psig/750°F
 Minimum exhaust pressure: 150 psig
 Maximum exhaust pressure: 200 psig

This particular turbine can have nine nozzles in the main bank and two nozzles in each hand valve port, respectively.

API specifications require that the turbine must be capable of producing maximum power at minimum inlet conditions and maximum exhaust conditions. Let us see what impact that has on a turbine designed to meet the normal conditions, including the extra 10 percent. A base case is shown in Table 2. What happens to the steam rate when the turbine is designed for the minimum/maximum condition is shown in Table 3.

Table 2. Base Case Steam Rate.

Steam conditions	Power	No. of nozzles	Steam rate	Percent excess nozzle area	Annual operating cost*
600/700/175	770	10	51.2	5.3	\$1.58 million
600/700/175	847	11		9.8	

* Using \$5.00/1000 lb and 8000 hours

Table 3. Minimum/Maximum Steam Rate.

	Power	No. of nozzles	Steam rate	Percent excess nozzle area	Annual operating cost*
600/700/175	770	11	54.6	28	\$1.68 million
600/700/175	847	11		17	
550/650/200	847	13		6	

* Using \$5.00/1000 lb and 8000 hours

As can be seen, the minimum/maximum condition determines the maximum nozzle area needed. When operating at normal conditions, the steam rate is affected because the turbine has to throttle at the normal condition. Adding another hand valve does not help. The nine nozzles in the main bank cannot produce design power.

Another point—the hand valves help the turbine designer to optimize the nozzling for the various operating conditions. What happens in the minimum/maximum case when the hand valves are not used is shown in Table 4. As can be seen, not using the hand valves has the biggest impact of all. If users ask their operators if they actually use the hand valves, they will probably say no. Using the hand valves could save over \$200,000/year!

Table 4. Results When Hand Valves Not Used.

	Power	No. of nozzles	Steam rate	Percent excess nozzle area	Annual operating cost*
600/700/175	770	13	58.7	52	\$1.81 million

* Using \$5.00/1000 lb and 8000 hours

It should be noted that automated hand valve operators are available that can open and close hand valves at predetermined set points. The cost of these automatic hand valves is relatively small compared to the potential savings.

Besides the effect on the steam rate, the governor valve may now be throttling close to the governor valve seat. This has two negative consequences—noise increases, and the potential for governor valve chattering increases. The lead author’s service group frequently gets calls from users during the startup cycle with these two complaints. Usually the answer is simple—go close the hand valves and call us back—and we never hear from them again. Worst case for the user—they do call back—asking to buy a smaller governor valve and/or a nozzle ring sized for the actual operating conditions.

There is yet another negative consequence of specifying a wide range of operating conditions and that is the impact it may have on turbine inlet, exhaust size, and maybe frame. To meet a minimum exhaust condition at acceptable velocities, the exhaust size may have to be larger than what is available on the least expensive frame that will do the job. This will force the manufacturer to go to a larger frame—adding cost not only to the turbine but also to the connecting piping, stop valves, relief valves, etc.

So the advice is as follows:

- Pump OEMs—Do not overspecify the power.
- Contractors—Do not use the worst-case scenarios on header pressure conditions unless they are real. If necessary, provide relief on the requirement of maximum power at minimum/maximum steam. Normal power is probably conservative enough.
- Users—You are not off the hook either. The hand valves are there for a reason—use them!

MULTISTAGE STEAM TURBINE APPLICATION ENGINEERING GUIDANCE

Generally, if a single-stage turbine meets the customer requirements, a single-stage offering will be preferred by most customers for price reasons. The price for a typical multistage turbine can be five to 20 times the price of a single-stage turbine that will perform the same function.

Multistage turbines are purchased where single-stage turbines are not suitable or improved efficiency is needed. Reasons include:

- Larger exhausts are needed than those available on single-stage units, usually on applications with condensing exhaust pressures.
- The steam rate or consumption is of greater importance to the customer. A multistage turbine is usually significantly more efficient than a single-stage turbine.
- The power requirement exceeds the capability of a single-stage turbine for blade loading reasons.

Comparing the multistage selection to the 770 horsepower base case example is shown in Table 5. The annual savings compared to the base case is \$350,000. The turbine initial cost could be \$300,000 more than the single-stage offering and still be a worthy investment.

Table 5. Multistage Compared to Base Case Example.

	Power	Steam rate	Annual operating cost*
600/700/175	770	40 lb/hp-hr	\$1.23 million

* Using \$5.00/1000 lb and 8000 hours

INSTALLATION AND MAINTENANCE

Steam turbines have proven to be a highly reliable driver for many duties. It is not uncommon for turbine life to be 20 years and longer. Turbines are relatively easy to maintain once the turbine is operational.

For installation, the turbine should have a sufficiently rigid foundation to maintain shaft alignment. Coupling must be properly aligned to avoid angular or parallel misalignment. Well-designed steam piping is needed to prevent imposing strains on the turbine casing, which can impact shaft alignment.

Maintaining the turbine involves assuring proper lubrication whether ring-oiled or pressure lubricated bearings are used. Clean, dry steam quality must be maintained and wet steam should be avoided in transient or steady-state operation. Routine operating and maintenance procedures—typically in the equipment instruction manuals—should be followed to assure trouble-free operation.

SUMMARY

The application of steam turbines for pump drives is very common, and choosing the right turbine can make a significant savings in initial cost and operating costs.

APPENDIX A—
TYPICAL MATERIALS OF CONSTRUCTION

Table A-1. Typical Materials of Construction.

<u>Part Name</u>	<u>Material Description</u>	<u>Material Spec</u>
<u>Casing and steam chest</u>		
Class I	High strength cast iron	ASTM A-278 Class 40
Class III	Cast carbon steel	ASTM A-216 WCB
<u>Rotor, built-up</u>		
Shaft	Chromium-molybdenum	AISI 4140 or AISI 4340
Disk	High strength steel	ASTM 517, Type B, AISI 4340
<u>Rotor, integral</u>	Nickel-vanadium-molybdenum	ASTM A-470 Cl. 4, 7 or 8
<u>Rotor blades</u>		
blades	12% chromium stainless steel	AISI 403
shroud band	12% chromium stainless steel	AISI 410
<u>Nozzle ring</u>		
	Carbon steel plate	ASTM A-516 Grade 60
<u>Packing cases</u>		
	Ductile iron	ASTM A-536
<u>Bearing cases</u>		
	Cast iron Steel	ASTM A-278 class 30 ASTM A-216 WCB
<u>Bearings</u>		
Retainer	Cold rolled steel	AISI 1018
Lining	Bonded babbitt	SAE 12
<u>Governor valve & seat</u>		
Valve and seat	Nickel alloy, ductile cast iron	D2, Ni-resist
Stem	304 stainless steel	ASTM A-479
<u>Trip valve & seat</u>		
Valve	Carbon steel	AISI C-1018
Seat	High strength cast iron or Cast steel	ASTM A-278, Class 40 ASTM A-216 Grade WCB

APPENDIX B— TYPES OF AERO STAGING

Smaller steam turbines usually use impulse type staging. With impulse type staging, the pressure drop across the stage is largely taken across the nozzle. There are two types of impulse staging—Curtis stages with two rotating rows of buckets, and rateau stages that have one row of rotating buckets. The Curtis stage offers relatively good efficiency over a wide range of operation. The rateau stage offers better peak efficiency, but is not as efficient as a Curtis stage at low velocity ratios (Figure B-1).

Typical Efficiency of Curtis and Rateau Stages

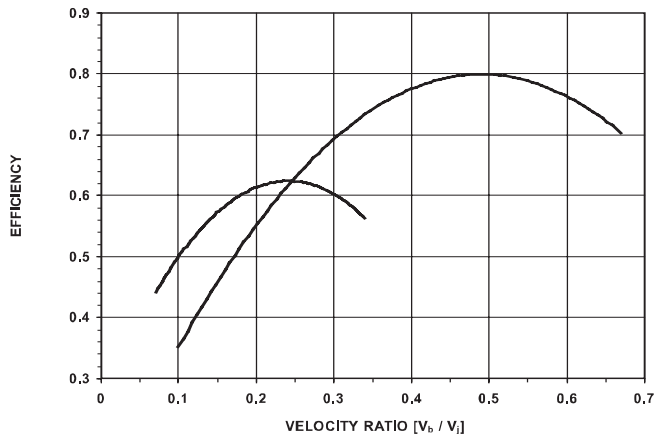

Figure B-1. Typical Efficiency Curves for Turbine Staging.

Reaction type staging is an alternative to impulse staging. Typically applied to noninlet stages, reaction type staging peaks at higher efficiency and velocity ratios. The pressure drop is taken across both the nozzle and the bucket, and hence the stage has more “reaction” and produces more downstream thrust load. More stages are typically needed and tighter clearances are needed to maintain the efficiency. Larger reaction turbines frequently have an impulse type inlet stage.

REFERENCES

- API Standard 611, 1997, “General-Purpose Steam Turbines for Petroleum, Chemical, and Gas Industry Services,” Fourth Edition, American Petroleum Institute, Washington, D.C.
- API Standard 612, 1995, “Special-Purpose Steam Turbines for Petroleum, Chemical, and Gas Industry Services,” Fourth Edition, American Petroleum Institute, Washington, D.C.
- ASME *Theoretical Steam Rate Tables*, 1969, American Society of Mechanical Engineers, New York, New York.
- NEMA Standard Publication SM-23, 1991, “Steam Turbines for Mechanical Drive Service,” National Electrical Manufacturers Association, Washington, D.C.

