

CHEMICAL ENGINEERING

March
2014

www.che.com

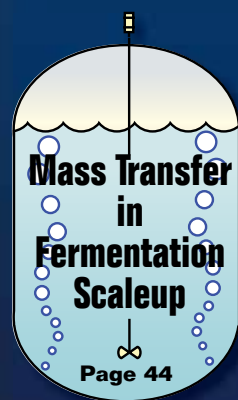

CORROSION Under Insulation: Revealing A Strategy

Page 40

**Pneumatic
Conveying**

**Minimizing
FDA Inspection
Citations**

**Focus on
Safety
Equipment**

**New and
Improved
Sensors**

**Global Air-
Pollution
Regulations**

**Advanced
Polymer
Recycling**

**Facts at Your Fingertips:
Level-Measurement
Device Selection**

**Interpex
Show Preview**

**Corrosion 2014
Show Preview**

THE STANDARD IN SAFETY HAS
A NEW NAME.



REDGUARD

A BOX 4 U IS NOW REDGUARD. Our name has changed, but our standards haven't. At RedGuard, we still produce the highest-quality, successfully tested blast-resistant buildings on the market, making us the industry's clear safety authority. LET US REINTRODUCE OURSELVES.

.....

SAFETY SUITE · **LEASE FLEET** · **COVER SIX**
SHELTERS

855.REDGUARD | redguard.com



Circle 1 on p. 68 or go to adlinks.che.com/50974-01

COVER STORY

- 40 Cover Story** **Implementing a Corrosion-Under-Insulation Program** CPI facilities need to put in place a systematic program for preventing and mitigating corrosion under insulation

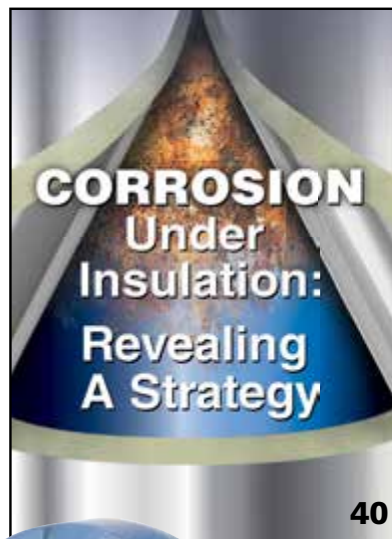

NEWS

- 11 Chementator** Commercial debut for a low-cost stationary energy-storage system; In-situ chemical remediation of soil and groundwater; This pathway from cellulose to *p*-xylene eliminates saccharification step; Bio-isobutene fermentation process to be piloted; New ceramic membranes for oxygen separation; and more
- 17 Newsfront** **Advanced Polymer Recycling** Polymer waste streams offer opportunities for new recycling processes
- 22 Newsfront** **Sensors Save the Day** New and improved sensors improve chemical processing applications in a multitude of ways



ENGINEERING

- 37 Facts at Your Fingertips** **Level-Measurement Device Selection** This one-page reference provides information about selecting devices for determining the level of materials in vessels and tanks
- 39 Technology Profile** **Methanol-to-Olefins Process** This one-page profile describes a process for production of light olefins from methanol
- 44 Feature Report** **Mass Transfer in Fermentation Scaleup** As fermenters are scaled up to huge sizes, mass transfer is a key consideration
- 48 Engineering Practice** **FDA Form 483: Minimizing FDA Inspection Citations** One of the paramount issues related to FDA-regulated products is that of documentation and record-keeping related to manufacturing
- 54 Solids Processing** **Dilute-Phase Pneumatic Conveying: Instrumentation and Conveying Velocity** Follow these guidelines to design a well-instrumented and controlled system, and to optimize its conveying velocity
- 59 Environmental Manager** **Global Air-Pollution Regulations: Variation is the Norm** Operators with facilities in many countries need to be aware of the requirements in each

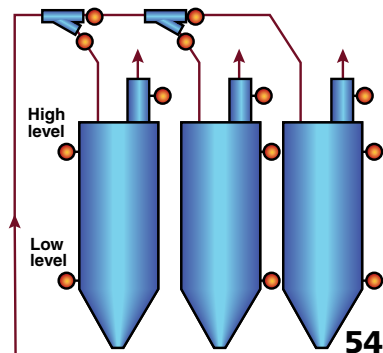

EQUIPMENT & SERVICES

26 **Focus on Safety Equipment**

Safety gloves for broader industrial use; Hands-free lighting for safety of first responders; This shield protects against high-pressure gage leaks; A cover to seal off drains in the event of a spill; Manage dust-explosion risk with safe indoor venting; and more

31 **New Products** Protect vacuum pumps from contamination with these traps; Translucent tubing for peristaltic pumps in high-purity operations; This programmable controller is installed directly on-machine; A high-accuracy, lightweight Coriolis flowmeter; and more

32I-16 **New Products (International edition)** Special vacuum pumps developed for fusion reactors; Precise dosing with multi-port, fluoroplastic valve blocks; A moisture analyzer with good connectivity; Mix steam and water for safe washdowns; and more

33 **Show Preview Interphex 2014** A selection of products to be displayed at this tradeshow, taking place March 18–20 in New York, for the pharmaceutical and biopharmaceutical industries

36 **Show Preview Corrosion 2014** The 69th annual meeting of the National Association of Corrosion Engineers (NACE) will be held in San Antonio from March 9–13. Here are some of the products that will be showcased at the event



26



31

COMMENTARY

5 **Editor's Page More than beer is brewing** Fermentation is broadening its reach to less traditional applications as a route to commercial-scale chemical production

65 **The Fractionation Column An unexpected safety lesson** The most important aspect of any safety program is thinking

DEPARTMENTS

- | | |
|--------------------------|-------------------------------|
| 6 Letters | 70 Who's Who |
| 8 Bookshelf | 71 Economic Indicators |
| 68 Reader Service | |

ADVERTISERS

32I-1 European Section

66 Product Showcase/Classified

69 Advertiser Index



33

COMING IN APRIL

Look for: **Feature Reports** on Solids Processing; and Compressors; an **Engineering Practice** article on P&ID Development; A **Focus** on Temperature Measurement and Control; A **Facts at Your Fingertips** on Fire Prevention; **News** articles on Carbon Capture; and Equipment for Handling Air-Sensitive Chemicals; and more

Cover: David Whitcher

ONLY ON CHE.COM

Look for Web-exclusive articles;
"Test your Knowledge"
quizzes; New Products;
Latest News; and more



We are *Keenly Focused* on towers and trays

This specialization allows us to be more responsive and more innovative in solving tower issues that have habitually plagued the industry. By focusing on our core competency of providing field services specifically for vessels, drums, towers and trays, we can address your exact needs. And, we can meet or exceed your safety, quality, time and budget requirements.

We provide complete retrofits and modifications for vessel internals on a scheduled or emergency basis. We've completed over 173 projects in the past four years alone. Part and parcel of our services are those ancillary skills that you would expect from a team of highly trained specialists; skills such as engineering services, design analysis, integrity analysis, re-rating, and welding (both "R" and "U" stamps), to name a few. This complete range of services is met to assure that your job is done right the first time.

Put the highly focused eyes of the tigers on your next project and you will be rewarded with an uncanny and rare level of excellence.



When you need tower services of any kind; HUNT NO MORE.

TIGER TOWER SERVICES



 **EMCOR**
Industrial Services

3012 FARRELL ROAD, HOUSTON, TX 77073 • PHONE: 281-951-2500 • FAX: 281-951-2520

www.tigertowerservices.com

Circle 12 on p. 68 or go to adlinks.che.com/50974-12

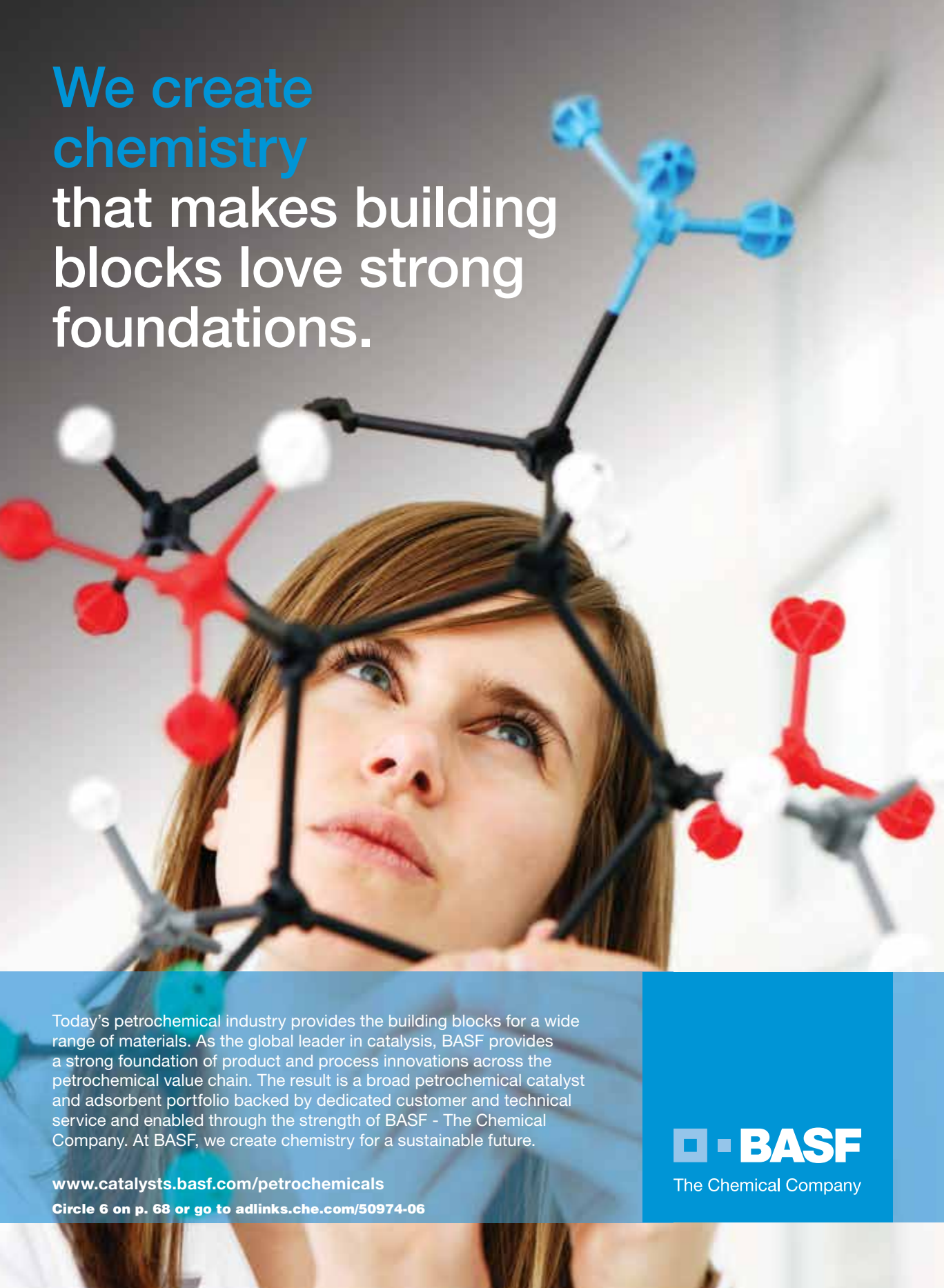
A woman with long brown hair and blue eyes is looking upwards with a thoughtful expression. She is holding a large, complex molecular model structure. The model consists of black spheres connected by black rods, with various colored spheres (red, white, blue, grey) attached to the black structure. The background is a bright, slightly blurred laboratory setting.

**We create
chemistry**
that makes building
blocks love strong
foundations.

Today's petrochemical industry provides the building blocks for a wide range of materials. As the global leader in catalysis, BASF provides a strong foundation of product and process innovations across the petrochemical value chain. The result is a broad petrochemical catalyst and adsorbent portfolio backed by dedicated customer and technical service and enabled through the strength of BASF - The Chemical Company. At BASF, we create chemistry for a sustainable future.

www.catalysts.basf.com/petrochemicals

Circle 6 on p. 68 or go to adlinks.che.com/50974-06

 **BASF**

The Chemical Company

Winner of Eight Jesse H. Neal
Awards for Editorial Excellence



CHEMICAL ENGINEERING

Published since 1902
An Access Intelligence Publication

PUBLISHER

MICHAEL GROSSMAN

Vice President and Group Publisher
mgrossman@accessintel.com

EDITORS

DOROTHY LOZOWSKI

Editor in Chief
dlozowski@che.com

GERALD ONDREY (Frankfurt)

Senior Editor
gondrey@che.com

SCOTT JENKINS

Senior Editor
sjenkins@che.com

MARY PAGE BAILEY

Assistant Editor
m Bailey@che.com

CONTRIBUTING EDITORS

SUZANNE A. SHELLEY

sshelley@che.com

CHARLES BUTCHER (U.K.)

cbutcher@che.com

PAUL S. GRAD (Australia)

pgrad@che.com

TETSUO SATOH (Japan)

tsatoh@che.com

JOY LEPREE (New Jersey)

jlepre@che.com

GERALD PARKINSON

(California) gparkinson@che.com

MARKETING

MICHAEL CONTI

Marketing Director
TradeFair Group, Inc.
michaelc@tradefairgroup.com

CRISTANE MARTIN

Marketing Manager
TradeFair Group, Inc.
cmartin@accessintel.com

HEADQUARTERS

88 Pine Street, 5th Floor, New York, NY 10005, U.S.

Tel: 212-621-4900

Fax: 212-621-4694

EUROPEAN EDITORIAL OFFICES

Zeilweg 44, D-60439 Frankfurt am Main, Germany

Tel: 49-69-9573-8296

Fax: 49-69-5700-2484

CIRCULATION REQUESTS:

Tel: 847-564-9290

Fax: 847-564-9453

Fulfillment Manager, P.O. Box 3588,

Northbrook, IL 60065-3588 email: chemeng@meda.com

ADVERTISING REQUESTS: see p. 68

For reprints, licensing and permissions: Wright's Media, 1-877-652-5295,
sales@wrightsmedia.com

ACCESS INTELLIGENCE, LLC

DON PAZOUR

Chief Executive Officer

ED PINEDO

Executive Vice President
& Chief Financial Officer

MACY L. FECTO

Exec. Vice President,
Human Resources & Administration

HEATHER FARLEY

Divisional President,
Access Intelligence

DANIEL MCKINNON

Vice President,
Energy and Engineering Events

ART & DESIGN

DAVID WHITCHER

Art Director/
Editorial Production Manager
dwhitcher@che.com

PRODUCTION

JOHN BLAYLOCK-COOKE

Ad Production Manager
jcooke@accessintel.com

INFORMATION SERVICES

CHARLES SANDS

Director of Digital Development
csands@accessintel.com

AUDIENCE DEVELOPMENT

SARAH GARWOOD

Audience Marketing Director
sgarwood@accessintel.com

GEORGE SEVERINE

Fulfillment Manager
gseverine@accessintel.com

JEN FELLING

List Sales, Statistics (203) 778-8700
j.felling@statistics.com

EDITORIAL ADVISORY BOARD

JOHN CARSON

Genike & Johanson, Inc.

DAVID DICKEY

MixTech, Inc.

MUKESH DOBLE

IIT Madras, India

HENRY KISTER

Fluor Corp.

GERHARD KREISA (retired)

DECHEMA e.V.

RAM RAMACHANDRAN

(Retired) The Linde Group

Editor's Page

More than beer is brewing

This year, the recipient of the Othmer Gold Medal is Kiran Mazumdar-Shaw, chairman and managing director of Biocon Ltd. (Bangalore, India; www.biocon.com). The award, which will be presented at the Chemical Heritage Foundation (CHF; Philadelphia, Pa.; www.chemheritage.org) in May, honors outstanding individuals who have made multifaceted contributions to our chemical and scientific heritage.

Kiran Mazumdar-Shaw is a pioneer in India's biotechnology industry. She was that country's first female brewmaster, and she went on to create a globally recognized bio-pharma enterprise. As Carsten Reinhardt, president and CEO of CHF said, "Then she used her knowledge of fermentation to become one of the greatest entrepreneurs in the history of her nation." One of Biocon's key innovations is the development of *Pichia*-based (a yeast) recombinant human insulin. The human insulin manufacturing process begins with fermentation.

Fermentation is playing an increasingly important role in the chemical process industries (CPI), and not just for the more traditional products made by that route, such as for the food-and-beverage and pharmaceutical sectors. The CPI are experiencing significant growth in bio-based chemicals (see for example, Bio-Based Chemicals Gain Market Acceptance, *Chem. Eng.*, August 2013, pp. 14-17; and The Bio-Based Economy, *Chem. Eng.*, August 2011, pp. 14-16), and a growing number of new processes are based on fermentation.

In this issue for example, we report on construction that is underway to build a pilot plant for what is believed to be the first fermentation process capable of directly producing isobutene (p. 12). Global Bioenergies (Evry, France; www.global-bioenergies.com) plans to start 500-L pilot operations later this year, and to scale up the fermenter next year. In our January issue, we reported on a new process for making lactic acid from palm waste (*Chem. Eng.*, January 2014, pp. 9-11) in a process that uses fermentation.

While new bio-based innovations seemingly continue to flourish, the use of fermentation in novel biological pathways to make high-value chemicals has already matured to production scale. A noteworthy example is the bio-based 1,4-butanediol (BDO) process developed by Genomatica Inc. (San Diego, Calif.; www.genomatica.com) — the winner of our most recent Kirkpatrick Chemical Engineering Achievement Award. Genomatica produced BDO at commercial scale using renewable feedstocks for the first time, via large-scale fermentation and recovery (for more on this winning achievement, see 42nd Kirkpatrick Award Announced, *Chem. Eng.* November 2013, pp. 14-19). And, in November 2013, BASF SE (Ludwigshafen, Germany; www.basf.com) reported that it produced its first commercial quantities of BDO using Genomatica's fermentation technology.

As fermentation broadens its reach as a route to commercial-scale chemical production, it becomes more important to learn about fermentation scaleup and some of the unique challenges it brings. This month's feature report on Mass Transfer in Fermentation Scaleup (pp. 44-47) focuses on the mass transfer aspect of the process, which is often a limiting factor in aerobic fermentation. It is a complementary article to Heat Transfer for Huge Scale Fermentation (*Chem. Eng.*, November 2013, pp. 44-46) that examines the heat transfer challenges in scaling up fermentation processes. ■

Dorothy Lozowski, Editor in Chief



Access
Intelligence

4 Choke Cherry Road, Second Floor
Rockville, MD 20850 • www.accessintel.com





Krytox® Fluorinated Lubricants

Greases and Oils are: Chemically Inert. Insoluble in common solvents. Thermally stable (-103°F to 800°F). Nonflammable. Nontoxic. Oxygen Compatible, Low Vapor Pressure. Low Outgassing. No Migration - no silicones or hydrocarbons. Krytox® offers Extreme Pressure, Anticorrosion and Anti-wear properties. Mil-spec, Aerospace and Food Grades (H-1 and H-2) available! Widely used in Vacuum and Cleanroom environments.

We also offer a complete line of inert fluorinated Dry Lubricants and Release Agents.

For technical information, call 800.992.2424 or 203.743.4447 (8AM - 4PM ET).

DuPont™ Krytox® Channel Partner Since 1991



miller-stephenson chemical company, inc.

California - Illinois - Connecticut - Canada
supportCE@mschem.com
miller-stephenson.com/krytox

Circle 25 on p. 68 or go to adlinks.che.com/50974-25

Call the Experts for all your solids processing.



Applications:

APIs · Ag-Chemicals
Artificial Sweeteners
Biologics · Catalysts
Ceramics · Chemicals
Cosmetics · Food Ingredients
Herbicides · Minerals
Nutraceuticals · Pesticides
Pharmaceuticals · Pigments
Polymers · Powdered Metals
Proteins · Resins · Vitamins

Vacuum Drying

Rota-Cone and V-Dryers

Solids Mixing

Rota-Cone and V-Blenders
Ribbon & Paddle Mixers
Fluidizing Dual Shaft Mixers
Sigma Mixers & Extruders

Size Reduction

Ball & Ceramic Lined Mills
Jars & Jar Rolling Mills

Manufacturing Quality Process Systems Since 1911

PAULO.ABBE

www.pauloabbe.com 800-524-2188 sales@pauloabbe.com

Circle 2 on p. 68 or go to adlinks.che.com/50974-02

Letters

CE scholarship applications open

Chemical Engineering is pleased to announce that applications are now being accepted for its annual Nicholas P. Chohey scholarship program.

Bringing recognition to the value of the chemical engineering profession, and striving to continually advance it, have been goals for this magazine since its founding in 1902. In late 2007, *Chemical Engineering* established the scholarship in memory of the magazine's former Editor in Chief.

Applicant qualifications. Applicants to the program must be current third-year students who are enrolled in a full-time undergraduate course of study in chemical engineering at one of the following four-year colleges or universities:

- Columbia University
- Rutgers University
- SUNY Buffalo
- University of Kansas
- University of Virginia
- University of Oklahoma

If selected as a recipient, the student will receive a one-time-only award that may be used for undergraduate study.

Application details. Qualified and interested students must complete the application and mail it along with a current, complete transcript of grades to the following address, postmarked no later than April 15.

Nicholas Chohey Scholarship Program
Scholarship Management Services
One Scholarship Way, P.O. Box 297
Saint Peter, MN 56082
Telephone: (507) 931-1682

Application forms will be sent directly to the chemical engineering departments of the qualified schools and can also be found at www.che.com/npcscholarship/

Selection of recipients. Scholarship recipients are selected on the basis of academic record, demonstrated leadership and participation in school and community activities, honors, work experience, statement of goals and aspirations, unusual personal or family circumstances, and an outside appraisal. Financial need is not considered.

Selection of recipients is made by Scholarship Management Services, a division of Scholarship America. In no instance does any officer or employee of *Chemical Engineering* magazine play a part in the selection. Recipients will be notified in early June.

Donations. To make donations to the fund, checks should be made out to Scholarship America, with "Nicholas Chohey Scholarship Program" in the memo area, and sent to the following address prior to June 1, 2014:

Nicholas P. Chohey Scholarship Fund
Cristane Martin
Chemical Engineering
11000 Richmond Avenue, Suite 690
Houston, TX 77042



Perfection is
Better Dispersion and Control



Perfecting Particle Size

The Sturtevant Micronizer® jet mill reduces the particle size of pesticides, herbicides, fungicides, insecticides and dry chemicals to narrow particle size distributions of 0.25 microns or larger without heat buildup.

- Better control properties - dispersion & reactivity
- Particle-on-particle impact, no heat generation
- Simple design, easy to clean
- Abrasion resistant for long life



348 Circuit Street Hanover, MA 02339 • Phone: 800.992.0209 • Fax: 781.829.6515 • sales@sturtevantinc.com

www.sturtevantinc.com

Circle 42 on p. 68 or go to adlinks.che.com/50974-42

For perfect production methods



Handling equipment

- Lifting, weighing, blending, pallet transfer
- Mobile or stationary
- Manual or fully automatic
- Loads up to 2500 kg handled
- Hygienic stainless steel
- GMP-compliant design
- ATEX conformity

Müller GmbH - 79618 Rheinfelden (Germany)
Industrieweg 5 - Phone: +49(0)7623/969-0 - Fax: +49(0)7623/969-98
A company of the Müller group
info@mueller-gmbh.com - www.mueller-gmbh.com

Circle 26 on p. 68 or go to adlinks.che.com/50974-26

RISE ABOVE THE NOISE

SoundPLAN® just elevated noise modeling software to new heights!

SoundPLAN 7.3 - now in 64 and 32 bit versions.
The most powerful indoor/outdoor noise simulation tool available. Build models from Google Earth, aerial surveys & other sources.

SoundPLAN Essential 3.0 - now with source library. Fast simulations for small to medium projects. Features our full calculation core with an easy-to-use interface.

Call or download a **FREE demo**:
+1 360 432 9840 www.soundplan.com



Available in multiple languages
with expert local support in nearly 50 countries.

Circle 41 on p. 68 or go to adlinks.che.com/50974-41

Bookshelf

An American Scientist. By Gabor A. Somorjai with Mitch Jacoby. Archway Publishing. 1663 Liberty Drive, Bloomington, IN 47403. Web: archwaypublishing.com. 2013. 250 pages. \$27.95.

Reviewed by Scott Jenkins, *Chemical Engineering* magazine, New York, N.Y.

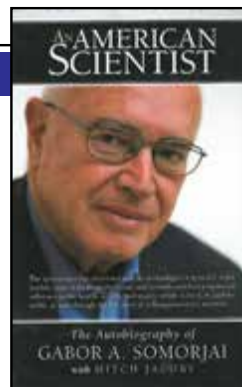

For those working in the chemical process industries, addressing the immediacies of work makes it difficult to ponder the scientific discoveries and technological advancements that led to the current state of the art. A book like the autobiography of the Hungarian-born scientist Gabor Somorjai reminds us that current technology has been shaped by a wide range of prior work.

On one level, Somorjai's autobiography is the story of a remarkable life spent in science — Somorjai is a decorated researcher who survived Nazi-occupied Hungary as the child of a Jewish family and eventually made a harrowing journey out of Soviet-era Hungary to the University of California at Berkeley, where he began studying chemical phenomena at surfaces. Providing historical context along the way, Somorjai illustrates in his book the many ways in which basic science research in the decades after World War II shaped the modern world.

On another level, the book is the story of science itself, exploring the process by which scientific information is acquired and eventually applied to industrial problems. Using the post-war progress of surface science as an example, Somorjai illustrates how basic research in the behavior of molecules at surfaces ultimately led to significant improvements in fields such as catalysis, tribology, microelectronics, energy storage, bioengineering and others.

Somorjai's book does an admirable job of succinctly describing the technical details of numerous scientific experiments and the implications of their results without letting the explanations obscure the themes of the narrative. Among the themes are the importance of human relationships and collaboration in advancing science. Somorjai makes it a point to give credit to an impressive network of colleagues and collaborators for research success. Another theme apparent in Somorjai's book is the preciousness of the scientific method as the mechanism by which incremental advances are made, questions are answered and thinking is changed.

Those with interest in the history of science will enjoy the book for its ability to chart a path outlining the progress of a key multidisciplinary field of science over time. Looking backward at the ways earlier work has shaped our present understanding of current technologies can be illuminating for the road ahead.

Editor's note: If you are interested in writing a book review for this column, contact *Chemical Engineering* senior editor Scott Jenkins by email at bookshelf@che.com.

Fuel and Combustion Systems Safety: What You Don't Know Can Kill You! By John R. Puskar. John Wiley & Sons Inc., 111 River Street, Hoboken, NJ 07030. Web: wiley.com. 2014. 346 pages. \$89.95.

Environmental Forensics for Persistent Organic Pollutants. Edited by Gwen O'Sullivan and Court Sandau. Elsevier Inc., 225 Wyman Street, Waltham, MA 02144. Web: elsevier.com. 2014. 424 pages. \$199.95.

Activated Sludge Technologies for Treating Industrial Wastewaters: Design and Troubleshooting. By W. Wesley Eckenfelder and Joseph Cleary. DESTech Publishing Inc., 429 North Duke Street, Lancaster, PA 17602. Web: destechpub.com. 2013. 234 pages. \$89.50.

Foams: Structure and Dynamics. By Isabelle Cantat, Sylvie Cohen-Addad, Florence Elias and others. Oxford University Press USA, 198 Madison Ave., New York, NY 10016. Web: oup.com. 2013. 288 pages. \$89.95.

A Real-time Approach to Process Control. 3rd ed. By William Y. Svrcek, Donald P. Mahoney and Brent R. Young. John Wiley & Sons Inc., 111 River Street, Hoboken, NJ 07030. Web: wiley.com. 2014. 360 pages. \$180.00.

Process Integration and Process Intensification: Saving Water, Energy and Resources. By Jiri Jaromir Klemes, Walter de Gruyter Inc., 125 Pearl Street, 3rd floor, Boston, MA 02110. Web: degruyter.com. 2014. 300 pages. \$840.00.

Fire Safety Management Handbook. 3rd ed. By Daniel E. DellaGiustina. CRC Press, Taylor & Francis Group, 37-41 Mortimer Street, London, W1T3JH. Web: crcpress.com. 2014. 279 pages. \$89.95.

Lees' Process Safety Essentials: Hazard Identification, Assessment and Control. By Sam Mannan. Elsevier Inc., 225 Wyman Street, Waltham, MA 02144. Web: elsevier.com. 2013. 570 pages. \$125.00. ■

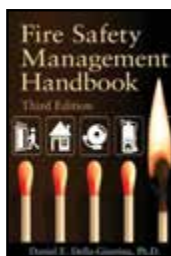
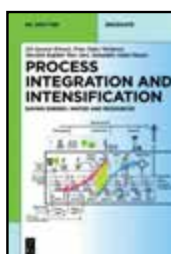
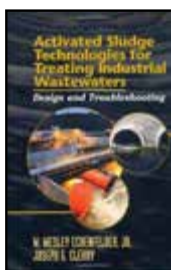
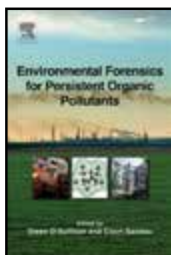

Scott Jenkins

Valveless Fluid Control for . . .

Lab, Process, Production, & OEM Instrumentation



PDS-100
Production Dispenser

Ideal for:

- Ampule & Vial Filling
- DNA & Protein Synthesis
- Liquid Chromatography
- R&D & Pilot Plant
- Pharmaceutical Pkg.
- Dissolution Systems



STH
OEM Pump

FMI Pumps Feature:

- Ceramic Internals
- One Moving Part
- Valveless Design
- 1% Accuracy, 0.5% C.V.

SEE US AT INTERPHEX
BOOTH #1459

FMI FLUID METERING, INC.
516-922-6050 / 800-223-3388
or visit us at www.fmipump.com

Circle 15 on p. 68 or go to adlinks.che.com/50974-15

FREWITT

FREDRIVE

THE 3-IN-1 PROCESS PLATFORM

3 milling processes with one system,
FreDrive offers the customer:

- 3 easily interchangeable mill heads
- 3 different grinding methods
- Ergonomic and very cost-effective
- Low maintenance and easy scale-up from laboratory to production



WE
CARE
ABOUT
MILLING
WWW.FREWITT.COM

VISIT US AT THE INTERPHEX IN NEW YORK, USA
FROM 18TH - 20TH MARCH 2014, BOOTH 2140

Circle 16 on p. 68 or go to adlinks.che.com/50974-16

You're building the future.
We're here to help.™



From commercial construction to industrial operations and public projects, the United Rentals team is proud to provide our customers the best equipment, tools and solutions in the industry.

 **United Rentals®**

UnitedRentals.com/Futures | 800.UR.RENTS

#URBuildingFutures    

Aerial | Earthmoving | Power & HVAC | Trench Safety | Tools | Technology

© 2014 United Rentals, Inc.

Circle 46 on p. 68 or go to adlinks.che.com/50974-46

Commercial debut for a low-cost stationary energy-storage system

A novel battery chemistry that uses a water-based electrolyte has allowed developer Aquion Energy Inc. (Pittsburgh, Pa.; www.aquionenergy.com) to achieve a low-cost and safe battery with long cycle life for stationary energy-storage applications. The Aquion battery technology, now entering its commercial launch process, employs an aqueous sodium-sulfate electrolyte. The water-based electrolyte makes the battery much safer than existing batteries that use organic-solvent-based electrolytes, says Jay Whitacre, chief technology officer of Aquion and leader of the research team at Carnegie Mellon University (Pittsburgh, Pa.; www.cmu.edu) that first developed the technology.

Sodium ions are used as the charge-carrying agent in the battery, and the electrodes are made from manganese oxide (cathode) with a cubic spinel structure, and a carbon composite material (anode). The anode hosts pseudocapacitive reactions of three different ions, Whitacre explains, namely Na^+ , Li^+ and H^+ . A simple non-woven cotton fiber material separates the electrodes in the battery.

“While these batteries are excellent for long cycle life, low-cost and safety, we sacrifice somewhat on energy density,” says Whitacre, but for stationary-storage applications, energy density is less of a concern than it is for vehicle batteries, where volume and weight are critical, he adds. The battery systems consist of one or more modular units of a battery that the company calls S10. Each unit is capable of delivering 150 kWh of power, and the battery cells can be linked for increased power.

Aquion has completed construction on a manufacturing line at its facility in Pennsylvania. The company expects that the batteries can be used in stationary long-duration energy-storage applications, such as microgrids, off-grid systems, integration of wind and solar power and others.

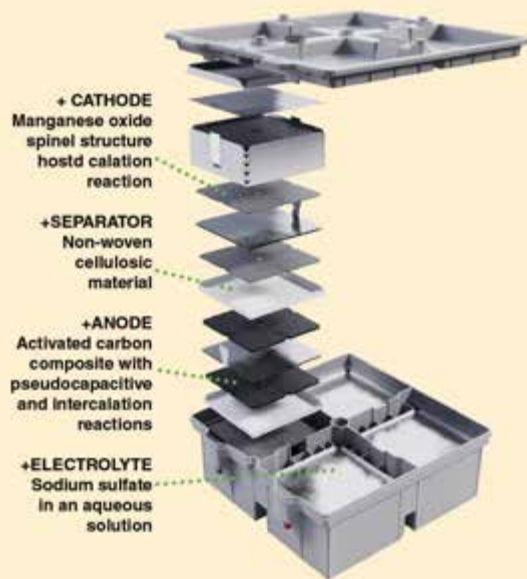

Renewable 5-HMF

Last month, commercial-scale production of high-purity 5-hydroxymethylfurfural (5-HMF) started at the Biochem-1 facility operated by AVA Biochem (Muttens, Switzerland; www.ava-biochem.com). In the first phase, the facility will produce 20 metric tons (m.t.) per year of 5-HMF — a compound that has been identified as one of the top ten platform chemicals that can be used for making polymers, resins and additives.

The production facility is said to be the first in the world to produce 5-HMF from renewable feedstock using a modified version of the hydrothermal carbonization technology (HTC), which was developed at the Karlsruhe Institute of Technology (KIT; Karlsruhe, Germany; www.kit.edu). HTC is a process that converts an aqueous suspension of biomass into biochar, in a closed reactor operating at high temperature and pressure. KIT modified the HTC method so that the formation of solid materials from the biomass is avoided.

AVA Biochem now offers commercial-scale quantities of 5-HMF with various levels

(Continues on p. 12)

In-situ chemical remediation of soil and groundwater

Geo-Cleanse International, Inc. (Matawan, N.J.; www.geo-cleanse.com) has developed a new method for ridding soil and groundwater of chloromethanes, Freon and other difficult-to-treat contaminants without the need for digging and offsite soil treatment. The Geo-Cleanse process was inspired by research at Washington State University by Rick Watts, who found that hydrogen peroxide could react with MnO_2 to generate superoxide radicals. These radicals can destroy highly oxidized species, such as chloromethanes. However, using H_2O_2 effectively in the field is challenging because the reaction between H_2O_2 and MnO_2 is difficult to control, says Dan Bryant, vice president of Geo-Cleanse.

Geo-Cleanse developed a way to overcome this challenge. By injecting phosphate buffers that control the soil pH and

form a ligand with manganese, the Geo-Cleanse process is able to slow the reaction between H_2O_2 and MnO_2 . The process begins with an injection of sodium permanganate into the soil, where reduced manganese precipitates as MnO_2 . Hydrogen peroxide is then injected to react with the MnO_2 and create the superoxide radicals.

In the first field use of the technique, Geo-Cleanse is remediating a brownfield site in New Jersey that has been heavily affected by chloromethanes. Concentrations of chloromethanes were well over 1,000 mg/kg in soil and 20–80 mg/L in groundwater. In the first field test, Geo-Cleanse also found that the H_2O_2 reacts with naturally occurring iron in the soil to generate hydroxyl radicals that destroy petroleum hydrocarbons, chlorobenzene and chlorinated solvents, Bryant says.

This pathway from cellulose to *p*-xylene eliminates saccharification step

A new chemical process is set to create bio-based *p*-xylene from cellulosic waste. Micromidas (West Sacramento, Calif.; www.micromidas.com) opened a pilot plant in December 2013 that converts cellulosic waste materials, such as rice hulls, switchgrass, sawdust and cardboard to bio-based *p*-xylene.

The Micromidas process is unusual in that it does not require the cellulose to be saccharified first, and both cellulose and glucose can be used as feedstock, with similar yields. In the first reaction step, cellulose is hydrolyzed and dehydrated to 2,5-chloromethylfurfural (CMF). In a subsequent reduction step, the CMF is reduced to dimethylfuran — typically, these sorts of reactions are hindered by the presence of chlorine, but this process completes the conversion in one step using a single catalyst. The final step is accomplished via a Diels-Alder cycloaddition of the dimethylfuran to ethylene,

followed by dehydration to *p*-xylene. According to the company, Micromidas is among the first to investigate the reaction from dimethylfuran to *p*-xylene at an industrial scale.

This process distinguishes itself from other bio-based chemical pathways in that it can achieve very high molar yields with high selectivity — it results in no other co-products that are common in conventional *p*-xylene manufacturing processes. Traditionally, *p*-xylene is produced in petroleum refineries from heavy naphtha reformat, resulting in a mixture of *p*-, *m*-, and *o*-xylene, which requires an additional adsorption separation step to reach a *p*-xylene product of desirable purity. Micromidas hopes its technology will provide a more direct means to high-purity *p*-xylene streams and allow producers of polyethylene terephthalate (PET) and polyesters to avoid having to purchase raw materials from refineries.

Bio-isobutene fermentation process to be piloted

Construction is underway in France on a pilot plant for what is believed to be the first fermentation process capable of directly producing the light olefin isobutene. Global Bioenergies (Evry, France; www.global-bioenergies.com) expects to begin operations of a 500-L fermentation facility in the second half of 2014 and plans to follow that with a 5,000-L fermenter in Germany the following year.

Isobutene is used in chemical applications, such as in the manufacture of butyl rubber, as well as for fuel applications, where it can be dimerized to produce iso-octane, a high-quality drop-in fuel for light passenger vehicles.

Global Bioenergies has engineered a unique metabolic pathway into a strain of *Escherichia coli* bacteria, enabling it to produce isobutene from glucose. To accomplish the feat, scientists had to develop a set of three proprietary new enzymes. The enzymes catalyze a series of reactions beginning with naturally occurring upstream products, but that produce novel intermediate species that are not metabolized by other cellular enzymes. The fermentation pathway ends

in isobutene, which is in a gaseous state at ambient temperature and pressure.

“One of the problems with many fermentation processes is that the target product is often toxic to the production strain of organisms,” explains Thomas Buhl, head of business development for Global Bioenergies. “By engineering a pathway to produce gaseous isobutene directly, we can avoid this toxicity because the product bubbles out of the fermentation broth and does not accumulate around the organisms.”

Generating a gaseous product also simplifies separation and reduces energy consumption, because no distillation is required to isolate the product, he adds.

In addition to the ongoing fermentation scaleup work, Global Bioenergies continues to optimize its enzymes' activities and boost expression of the genes for the enzymes, hoping to commercialize a process by 2017. The company is also investigating various feedstocks other than glucose, Buhl says. After an initial commercial facility is built, the company seeks to license its technology to others for production.

(Continued from p. 11)

of purity — up to 99.9% — for testing and product development by industrial and research customers. In parallel to current production, KIT and AVA Biochem are optimizing the production process.

Biogas liquefaction

Last month saw the inauguration of a biogas liquefaction plant, which was delivered by Wärtsilä Oy (Helsinki, Finland; www.wartsila.com) to Cambi AS (Oslo, Norway), a specialist in biotreatment. The plant, operated by Cambi on behalf of the Waste-to-Energy Agency (EGE; Oslo) and the city of Oslo, will produce biomethane from household food waste to be used as bio-fuel in buses in Oslo.

The plant, located in Nes, Romerike, an agricultural region close to Oslo, will treat 50,000 ton/yr of food waste to produce around 14,000 Nm³/d of biomethane. The biogas is then liquified using Wärtsilä's technology, which uses a mixed refrigerant in combination with conventional equipment to make small-scale LNG plants economical, says the company. The liquified biogas can be efficiently transported and used as fuel.

Methane-to-ethylene

Siluria Technologies (San Francisco, Calif.; www.siluria.com) and Braskem S.A. (Sao Paulo, Brazil; www.braskem.com.br) have recently formed a broad-ranging collaboration around the deployment of Siluria's proprietary oxidative coupling of methane (OCM) technology for the direct conversion of methane in natural gas to ethylene.

Under the collaboration, Siluria and Braskem will jointly explore commercial deployment of Siluria's technology for supplying ethylene to Braskem. In particular, the two companies will conduct a joint feasibility study to identify commercial deployment opportunities of Siluria's technology at Braskem's ethylene-consuming plants.

Siluria's OCM technology provides a novel process for

(Continues on p. 14)

Recovering and purifying byproduct and waste ethylene glycol

GlyEco Inc. (Phoenix, Ariz.; www.glyeco.com) has developed a process for recovering and purifying ethylene glycol from a number of industrial byproduct and waste streams so that it meets an ASTM International (West Conshohocken, Pa.; www.astm.org; formerly American Society for Testing and Materials) specification for use in virgin-grade antifreeze.

Processes for recycling ethylene glycol currently exist, explains Richard Geib, GlyEco's chief technical officer, but they are based on used antifreeze — a relatively expensive feedstock that is in short supply — and result in ethylene glycol that generally does not have the purity required for top grades. GlyEco's process enables the recycling of ethylene glycol not only from used antifreeze, but also from several different minimal-cost industrial byproducts and waste streams. These waste streams include byproduct from the manufacture of polyethylene terephthalate (PET) plastic, ethylene oxide medical sterilization, aircraft de-icing fluid and others.

A unique feature of the GlyEco process is a pre-treatment step where ethylene-glycol-containing streams from different industries and with varying chemical compositions are put through a series of proprietary physical and chemical operations that make them all similarly suitable for the primary treatment step. After careful analysis of potential feedstock streams, GlyEco developed "laboratory processes to chemically modify problematic components of these streams so that they could be purified to a very high level using relatively standard unit operations, such as filtration, phase separation, vacuum distillation and ion exchange," Geib says. Several species of organic impurities, inorganic ions, acid and color need to be removed sufficiently to achieve virgin-grade ethylene glycol.

In the primary treatment step, a sophisticated vacuum-distillation system separates relatively pure ethylene glycol from more- and less-volatile contaminants. That is followed by a post-treatment step, where remaining ionic species, acid and color are removed to produce ethylene glycol that meets the virgin-antifreeze-grade specification, Geib points out.

Recycled ethylene glycol from GlyEco's process has a significant cost advantage over virgin ethylene glycol from petrochemical facilities, Geib says. GlyEco's plant in Elizabeth, N.J. is producing and selling commercial quantities of virgin-grade ethylene glycol in the first step of a phased startup that is expected to reach 10 million gal/yr by the later part of 2014.

Partner with the Best

SAMSON



AIR TORQUE

CERA SYSTEM[®]
more than ceramics

KT Elektronik

LEUSCH

Pfeiffer
Chem- und Anlagenbau GmbH

RINGO VALVULAS

SAMSOMATIC GMBH

STAR LINE

VETEC
Ventiltechnik GmbH

With over 50 independent subsidiaries and more than 220 engineering and sales offices spread across the world, SAMSON ensures the safety and environmental compatibility of your plants on any continent.

To offer the full range of high-quality control equipment used in industrial processes, SAMSON has brought together highly specialized companies to form the SAMSON GROUP.

SAMSON AG · MESS- UND REGELTECHNIK
Weismüllerstraße 3
60314 Frankfurt am Main · Germany
Phone: +49 69 4009-0 · Fax: +49 69 4009-1507
E-mail: samson@samson.de · www.samson.de
SAMSON GROUP · www.samsongroup.net

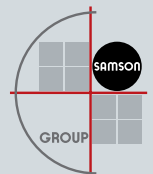

Circle 38 on p. 68 or go to adlinks.che.com/50974-38

A0120EN

New ceramic membranes for oxygen separation

Researchers from Curtin University's Fuels and Energy Technology Institute (Perth, Western Australia; www.curtin.edu.au), led by professors Gordon Parkinson and Chun-Zhu Li, have won the Mitsubishi Corp. Western Australia Innovator of the Year award for creating a new membrane that speeds up the transfer of oxygen.

Currently, industrial oxygen production relies on a cryogenic process, which requires a large capital investment and high operating costs. A potentially cheaper process uses oxygen-permeation membranes to separate oxygen from air, based on the differences between the oxygen partial pressures on the two sides of the membrane. Although improvements have been achieved by coupling the oxygen permeation membrane technology with high-temperature reactions such as methane conversion and oxyfuel combustion, the oxygen fluxes achieved have been too low. Also, the materials employed for the membranes have not been sufficiently stable or resistant to contamination.

The university researchers created a novel microchanneled structure of oxygen permeation membranes using a mesh-templating, phase-inversion method (diagram), whereby a ceramic slurry in a polymer solution is cast into a mold and covered with a mesh. Water then diffuses through the apertures of the mesh, selectively displacing the original solvent, to form channels. After sintering, the resulting structure is strong, resistant to thermal shock and a

good conductor of oxygen ions. The membranes contain many parallel microchannels crossing their thickness with one end open and the other end stopped by a thin layer. According to the researchers, that structure increases oxygen flux by a factor of five compared with conventional dense, thick membranes.

The researchers increased the oxygen flux still further by using dual-phase membranes and applying catalysts. Both the oxygen ionic conductivity and the electronic conductivity of ceramic membranes affect the oxygen permeation. When oxygen ions diffuse through the membrane from the oxygen-rich side to the oxygen-lean side, electrons move in the opposite direction to maintain electrical neutrality within the membrane. Balanced ionic and electronic conductivities are therefore required to achieve high oxygen fluxes. The researchers used two types of materials: fluorite and perovskite ceramics. Compared with pure $\text{La}_{0.6}\text{Sr}_{0.4}\text{Co}_{0.2}\text{Fe}_{0.8}\text{O}_{3-\delta}$ (LSCF) membranes, LSCF- $\text{Ce}_{0.8}\text{Gd}_{0.2}\text{O}_{2-\delta}$ (GDC) dual-phase membranes increased oxygen flux by 57% due to the balanced oxygen ionic and electronic conductivities.

The open microchanneled structure facilitated the coating of catalysts, such as silver and platinum, on both sides of the membranes. The catalysts increased the oxygen fluxes of both pure LSCF membranes and dual-phase membranes.

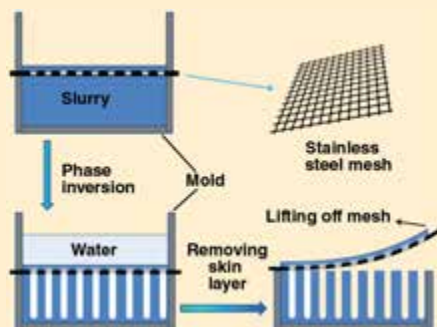

(Continued from p. 12)

the conversion of methane from natural gas to ethylene and liquid fuels (for more details, see *Chem. Eng.*, December 2010, p. 12). Siluria's demonstration plant is expected to be operational by the fourth quarter of 2014.

Recycling composites

Last month, Saperatec GmbH (Bielefeld, Germany; www.saperatec.de) commissioned a pilot plant capable of processing 500 m.t./yr of composite waste materials, such as plastic-plastic and plastic-aluminum-laminates used in beverage containers. The plant uses Saperatec's patented wet-chemical process, based on micro-emulsion technology, which is able to recycle 100% of the components, says the company. In addition to packaging materials, the process can recycle automobile glass and photovoltaic modules, the company says.

Organic corrosion inhibitors perform well against oxidizing biocides

After extensive pilot- and field-testing, U.S. Water Services (St. Michael, Minn.; www.uswaterservices.com) plans to roll out new "green" corrosion inhibitor products, which have been tested not only for effectiveness against corrosion in cooling-water applications, but also for the inhibitors' performance in the presence of oxidizing biocides, such as sodium hypochlorite. Oxidizing biocides are used to protect against biological issues in water systems, including the presence of bacteria in wastewater streams, but are notorious for their detrimental

effect on certain corrosion inhibitors. Due to their organic nature, so-called "green" corrosion inhibitors may be especially susceptible to oxidation. However, research from U.S. Water Services suggests that some organic inhibitors actually outperformed traditional treatment methods, even under oxidative conditions.

In U.S. Water Services' studies, many organic compounds were tested as potential corrosion inhibitors. To be considered "green," a number of criteria were examined, including the compounds' biodegradability, toxicity and heavy metal

status, as established by the Environmental Protection Agency (EPA; Washington D.C.; www.epa.gov). Based on these criteria, the favorably green compounds included aspartic acid polymer (AAP), phosphonocarboxylic acid mixture (PCM), hydroxyphosphonic acid (HPA) and polyamino-phosphonate (PAP). In a synthetic mild-steel system with soft water, the green corrosion inhibitors performed better and had potentially lower operating costs when compared to traditional treatment methods, such as zinc- or molybdate-containing products.

Chemicals from birch bark

Sawmills and pulp mills in Finland generate large quantities of birch bark, which is currently burned for making heat and electricity. But half of the bark (by weight) consists of betulin and fatty acids of suberin — compounds that could replace pine oil and resin for making products, such as fine chemicals, glues and paints. Researchers from VTT Technical Research Center of Finland (Espoo; www.vtt.fi), in cooperation with Savonlinnan yrityspalvelut Oy (Savonlinna, Finland) and local companies, are assessing the production potential of such compounds with the aim to create bark-based products. □

A new spin on enzymatic reactions

A new process-intensification technology to accelerate the rate of enzymatic reactions has been developed by researchers from the Dept. of Chemical Engineering, University of Bath (U.K.; www.bath.ac.uk). The so-called spinning cloth disc reactor (SCDR) is based on, but extends the principles of, the conventional spinning disc reactor (SDR). The SCDR also uses centrifugal forces to allow the spread of a thin film across a spinning horizontal disc. However, this disc has a cloth with immobilized enzyme resting on top of it. The SCDR therefore produces a flow of thin film both on top of, as well as through the enzyme-immobilized cloth, providing a large interfacial surface area for the reaction, explains Emma Emanuelsson, who co-developed the SCDR with colleague Darrell Patterson (both lecturers at the university).

The cloth not only serves as the support for the enzyme, but has the additional benefit of increasing the residence time per pass on the disc compared to SDRs. This higher contact time with the enzymes, as well as the enhanced mixing and mass transfer in the thin film, improves the reaction time, rate and yield compared to a conventional stirred-tank reactor (STR), says Patterson. The improvements were observed using the hydrolysis of tributyrin as a test reaction, with a lipase enzyme immobilized on a wool cloth.

Under comparable reaction conditions, the SCDR proceeded at a higher rate than in the STR, giving a higher conversion over the entire hydrolysis process at all the investigated concentrations. For example, for a 20 g/L solution of tributyrin, a 65% conversion was achieved after 240 min in the SCDR, compared to a 52% conversion in the STR. The immobilized enzyme was also found to show excellent stability, retaining 80% of its original activity after 15 consecutive runs, says Emanuelsson.

As is the case with conventional SDRs (and microreactors), the technology is most suited to small-scale reactions, such as the synthesis of high-value products, says Patterson. For commercial production, the reactors would be numbered up rather than scaled up, he says. ■

Visit us!
interpack 2014, Düsseldorf, Germany
May 8 – 14, 2014
Hall 12, stand D36

Visit us!
CeMAT 2014, Hanover, Germany
May 19 – 23, 2014
Hall 27, stand H32

**SOME THINK
A 90%
DECREASE
IN ENERGY
USE WILL
COMPROMISE
THROUGHPUT.
WE THINK
DIFFERENT.**

At BEUMER we have a reputation for making things a little different. Take the stretch-film pallet packaging system, BEUMER stretch hood®. In a sector where energy-intensive shrink hooding is still common, BEUMER stretch hood® uses a non-thermal stretch-film system. The result: better load stability, higher throughput, up to 10 times less film consumption and 90% energy savings. All this makes a big difference to productivity – and to the environment.

For more information, visit www.beumergroup.com

Circle 8 on p. 68 or go to adlinks.che.com/50974-08



BEUMER
BEUMERGROUP

**MADE
DIFFERENT**

Would you like to reduce failure risks in your heat exchangers, while spending less?



Visit us at **NACE / Corrosion 2014**

9 - 13 March 2014, San Antonio, USA Stand No. Hall C - 1339

Sandvik customers are installing heat exchanger tubes that are more resistant to corrosion, while costing significantly less. This is because Sandvik controls its full production cycle with an expert knowledge of specialty steelmaking.

Hyper-duplex Sandvik SAF 2707 HD™ heat exchanger tubing is 20% more resistant against corrosion that causes premature equipment failure and plant downtime. It can also withstand higher operational temperatures with thinner tube walls, for significant weight and material cost savings.

Sandvik Materials Technology continues to build on its 150 years of heritage as a leading and trusted industrial stainless steel supplier. Customers can benefit from the full expertise of Sandvik at every stage of design and development, with more rigorous quality controls than any official standard.



CHALLENGE
YOUR EXPECTATIONS

Sandvik and Sandvik SAF 2707 HD are trademarks owned by Sandvik Intellectual Property AB.



www.smt.sandvik.com

ADVANCED POLYMER RECYCLING

Polymer waste streams provide opportunities for new recycling processes

Polymers like polyethylene, polypropylene, polyvinyl chloride and polyester have become ubiquitous in manufacturing. The properties of polymer-based materials that make them so desirable — they are generally cheap to produce and boast high chemical and thermal stability — also make them abundant, disposable and, in many cases, non-degradable. As landfill space decreases, and with some European countries taking measures to completely banish these materials from landfills, many companies see an opportunity to capitalize on these waste streams by converting them into something more valuable. Taking advantage of the availability of post-consumer and post-industrial waste, new technologies for recycling are being developed globally. This article examines some of the technologies aimed at recycling and repurposing polyolefins, vinyls and textiles, as well as some of the challenges facing the recycling industries.

Re-energizing polyolefins

Often, waste materials are incinerated to generate heat and electricity, but polyolefins can actually provide much richer end-of-life options. Vadxx Energy LLC (Cleveland, Ohio; www.vadxx.com) hopes to create a new destiny for end-of-life polyolefins. In January, the company received financing to build a commercial-scale plant in Akron, Ohio, which will convert non-hazardous,



FIGURE 1. The main products from the Vadxx process are diesel additives and wax, with feedstock from sources like materials-recovery facilities (MRF) and paper-processing plants

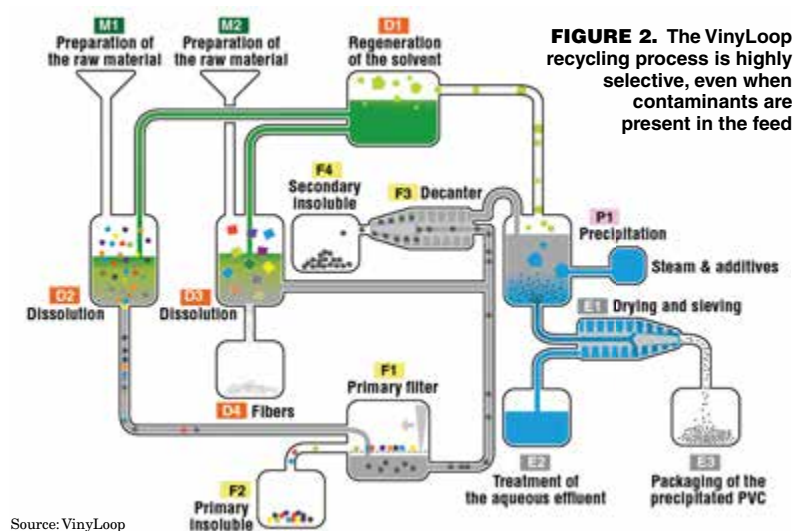

FIGURE 2. The VinylLoop recycling process is highly selective, even when contaminants are present in the feed

post-industrial polyolefin waste (that would otherwise end up in landfills), from sources including wiring insulation and spent industrial absorbents, into energy products. The main commercial end products are additives (for ultra-low-sulfur diesel or distillate fuels) and waxes (Figure 1). The recycling process also creates fuel gas that can be used for heating requirements elsewhere in the process.

After more than three years of successful pilot-plant operation, the technology will be scaled up by a factor of 50 at the new facility, with startup scheduled for 2015. The plant is designed to process around 55 metric tons (m.t.) per day of waste, which

corresponds to nearly 300 bbl/d of diesel additives.

Rockwell Automation Global Solutions (Milwaukee, Wisc.; www.rockwell.com) secured a \$15 million contract for the provision of engineering, procurement, construction and management services for Vadxx's facility. Rockwell has also developed a standard, modular design based on this plant for future construction and licensing. "The Vadxx technology of transforming end-of-life plastics into higher-value energy products is an effective sustainability solution with global implications," says Terry Gebert, vice president and general manager, Rockwell Automation Global Solu-

tions. "Our process and automation engineering expertise, coupled with our process automation system, will provide the necessary tools to drive success. By utilizing our multi-discipline control platform to deliver an integrated smart plant for Vadxx, it will enable them to rapidly deploy this technology globally."

In development for over seven years, the Vadxx process consists of a series of standard unit operations (heating, cleaning and cooling) in a continuous, progressively zoned system. There is no combustion occurring in the system; rather, materials are melted and boiled under controlled environmental condi-

tions. The subsequent thermal decomposition of these liquids results in hydrocarbon vapors that are condensed into the various products.

Upon commercial success at the new plant, the next steps for Vadxx will be to increase its breadth of feedstocks to include post-consumer waste, and to move the technology closer to the materials' point of generation to simplify transportation and logistics. By expanding its feedstock capabilities and moving into post-consumer waste-processing, Vadxx doesn't see its technology as a competitor to traditional polyolefin recyclers, more of an augmented or complementary process, says Jeremy DeBenedictis, vice president of operations and engineering. Vadxx's feedstocks are focused on difficult-to-recycle materials, including those that are contaminated or off-specification, which cannot be accepted by conventional recycling processes.

Solving a PVC problem

Polyvinyl chloride (PVC) is notoriously difficult for recyclers to process when mixed with other materials. According to guidelines published by the Association of Postconsumer Plastic Recyclers (APR; Washington, D.C.; www.plasticsrecycling.org), PVC is considered to be a contaminant in facilities that process typical plastic bottles, such as those constructed from polyethylene terephthalate (PET) or high-density polyethylene (HDPE) materials. And conversely, the presence of PET (even in minute amounts) can severely hinder some PVC-recycling processes. Despite some of the inherent challenges in recycling PVC, VinylPlus (Brussels, Belgium; www.vinylplus.eu), a European organization consisting of many vinyl producers and recyclers, has set forth a goal among its members to develop innovative technologies that will result in the recycling of 100,000 m.t./yr of PVC, leading up to a target of 800,000 m.t./yr of PVC being recycled by 2020. Meeting recycling goals for PVC and other waste materials is crucial in Europe, where nine countries have landfill bans in place.

Need Muscle?

1972 Buick GS Stage 1

Do you have flows up to 1,400 US GPM (320 m³/hr), heads up to 3,400 feet (1,000 m), pressures up to 1,500 psig (100 bar), temperatures from 20 °F to 300 °F (-30 °C to 149 °C), and speeds up to 3,500 RPM? Then you need Carver Pump RS Series muscle!

RS Series

Designed for moderate to high pressure pumping applications, the RS is available in five basic sizes with overall performance to 1,000HP. As a standard, with a product lubricated radial sleeve bearing and two matched angular contact ball bearings for thrust, it only takes a mechanical seal on the low pressure, suction side to seal the pump. Optional features include ball bearings on both ends with an outboard mechanical seal, various seal flushing arrangements and bearing frame cooling. These features make the RS ideally suited for Industrial and Process applications including Pressure Boost Systems, Boiler Feed, Reverse Osmosis, Desalination and Mine Dewatering. Whatever your application, let us build the muscle you need!

Carver
Creating Value.

Carver Pump Company
2415 Park Avenue
Muscatine, IA 52761
563.263.3410
Fax: 563.262.0510
www.carverpump.com

75th
Carver
SINCE 1938

Circle 10 on p. 68 or go to adlinks.che.com/50974-10



Source: Teijin

FIGURE 3. The proprietary chemical process behind Teijin's Eco Circle technology creates recycled polyester fibers that are of equal quality to polyester produced from all-new materials

One company that is contributing to the goals of VinylPlus is VinyLoop Ferrara S.p.A. (Ferrara, Italy; www.vinyloop.com), a partnership between Solvay and Serge Ferarri. VinyLoop specializes in the physical recycling of post-industrial composite PVC waste that cannot be recycled using traditional mechanical processes, often due to contamination from glue, polyester, metals and polyolefins. Currently, VinyLoop operates a plant in Italy that treats 10,000 m.t./yr of PVC scraps, much of which comes from discarded electrical cables. The VinyLoop process (Figure 2) is solvent-based, consisting of dissolution, filtration and centrifuge steps, resulting in a recycled PVC (R-PVC) micro-granular product with a quality similar to that of "virgin" PVC.

At its site in Italy, the company has also inaugurated the newer TaxyLoop technology, which processes textiles coated with PVC, such as advertising banners and tarpaulins — even fabrics used in temporary structures at London's 2012 Olympic Games. Sorted and shredded fabric materials are shipped to the site, from collection depots across Europe and as far away as Australia, and are fed to the recycling process, where the fibers are dissolved, filtered and extracted, resulting in R-PVC and recycled polyester fibers. The fibers can be used in the production of heat and sound insulation, water-retention membranes, clothing and home furnishings.

As of now, TaxyLoop is the only commercial recycling process for flexible PVC-coated composite textiles. The company estimates that it processes 4 million m²/yr of fabric. Life-cycle assessment studies show that the TaxyLoop process has a smaller environmental footprint than simply incinerating waste textiles. In the future, VinyLoop hopes to license both of its PVC technologies to clients who have an abundance of PVC waste, or those that use PVC as a raw material.

A second life for textiles

In addition to the TaxyLoop process, technologies from other companies are looking for ways to utilize

textile waste, as production and disposal of these materials continues to rise. According to the Fiber Economics Bureau (Arlington, Va.; www.fibereconomics.com), worldwide annual production capacity for textile fibers has increased five-fold over the last 10 years.

Engineering Excellence has now become

Engineering Excellence³

ThyssenKrupp Uhde and
 ThyssenKrupp Resource Technologies are now
ThyssenKrupp Industrial Solutions

Introducing ThyssenKrupp Industrial Solutions, a new company that combines the strengths of ThyssenKrupp Uhde with those of ThyssenKrupp Resource Technologies, itself the product of last year's merger between ThyssenKrupp Fördertechnik and ThyssenKrupp Polysius.

We now provide expertise in the engineering and construction of chemical plants, refineries, cement works and other industrial complexes as well as advanced technologies for mining, mineral processing and bulk materials handling systems.

Engineering Excellence³: a new dimension of true expertise for customers everywhere. Why not contact us today?

www.thyssenkrupp-industrial-solutions.com

ThyssenKrupp
 Industrial Solutions

FIGHTING FUNGI WITH PLASTIC

Researchers at Singapore's Institute of Bioengineering and Nanotechnology (IBN; Singapore; www.ibn.a-star.edu.sg), in collaboration with IBM Research Almaden (San Jose, Calif.; www.research.ibm.com), have discovered that recycled polyethylene terephthalate (PET) can self-assemble into nanofibers that have fungi-killing capabilities — potentially providing a means of overcoming drug-resistant species of fungi. According to Yi Yan Yang of IBN, PET is a perfect candidate for transformation into nanofibers, due to its ability to depolymerize using an organic catalyst into cationic compounds possessing both a rigid structural motif and hydrogen-bonding acceptors and donors. "This unique combination is ideal to generate nanofibers through self-assembly. Our nanofibers can be easily functionalized with cationic charges to target microbes," Yang explains. Post-consumer PET from bottles and packaging has been used in the research, with Yang stating that even colored bottles can be used, since the dyes are filtered out. The process begins with PET flakes in the presence of triazabicyclodecene and 4-aminobenzylamine. After a series of reactions, the eventual result is the small-molecule cationic compounds that subsequently assemble into nanofibers when placed in an aqueous solution. These nanofibers are able to use electrostatic interactions to selectively target fungal cells and kill them by penetrating the cells' membranes. The selectivity of these compounds sets them apart from existing antifungal agents, some of which cannot distinguish between fungal cells and mammalian cells and can potentially attack the wrong cell. The fungal-elimination power of the nanofibers is seen in the side-by-side photos here, comparing scanning-electron-microscope images of a *C. albicans* biofilm before (top) and after (bottom) treatment with the nanofibers. The next step for this discovery is commercialization — IBN and IBM have been collaborating with several companies to get this technology rolled out to the pharmaceuticals industry. □

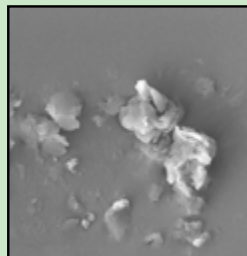
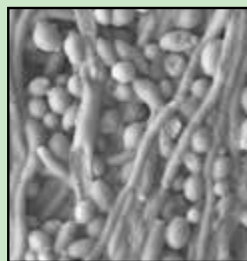

One solution is found in the Eco Circle technology (Figure 3) from Teijin Ltd. (Tokyo, Japan; www.teijin.co.jp), which recycles polyester fabrics through a closed-loop proprietary chemical process — the first of its kind in the world, says the company. Eco Circle's process chemically decomposes polyester and converts it back into polyester. Also, according to Teijin, the Eco Circle technology requires less energy and produces fewer emissions than producing new polyester fibers from petroleum.

The main source of waste polyester for Eco Circle is worn-out clothing, which is collected by the over 150 members of Eco Circle's business network — mainly retail stores and apparel-producing companies. What sets Eco Circle apart is the repeatability of its technology. Rather than "downcycling" to lower-quality products, the Eco Circle process allows for polyester to be recycled multiple times into usable textiles, such as uniforms for factory employees.

In a partnership announced in December 2013 with Fuji Xerox Co., Ltd. (Tokyo; www.fujixerox.com) and Shanghai's Onward Trading, a designer and manufacturer of uniforms, Teijin has applied the Eco Circle process to provide uniforms made of recycled polyester to workers at various Fuji Xerox facilities in China. Once the uniforms reach the end of their useful lives, they will be sent to the new recycling plant of Zheji Jiang Jiaren New Materials Co., a joint venture between

Teijin and the Jinggong Holding Group that was established in September 2012. When this new recycling plant starts up later this year, the polyester recycled there will be eventually used to again manufacture uniforms for Fuji Xerox, closing the loop. The next step for Eco Circle will be increasing its network to integrate not just polyester from fibers and fabrics, but from other sources, such as plastic bottles and films.

Post-consumer challenges

Despite the boom in innovative recycling technologies, concerns loom on the horizon for both manufacturers and recyclers. As environmental regulations continue to tighten, new developments in bio-sourced and degradable chemicals are coming to the forefront and changing the landscape of polymer processing. The APR has published guidelines related to end-of-life options for bio-based and degradable plastics, which in many cases cannot be processed in the same manner as conventional plastics. Plastics Recyclers Europe (PRE; Brussels, Belgium; www.plasticsrecyclers.eu) also warns of the concerns related to the recycling of such materials by emphasizing that specific end-of-life solutions must be implemented on a large scale in order to truly evaluate the sustainability of manufacturing these alternative materials.

First, an important distinction must be made between "bio-based," "biodegradable" and "degradable" materials. Bio-based products in-

volve monomers that were originally sourced from plants or other biological raw materials. Most bio-based plastics are physically the same as their conventional petroleum-based counterparts (for instance, PE or PET) — being bio-based doesn't make them inherently more biodegradable. Although some bio-based plastics are biodegradable, recycling solutions must be developed for those that are not. European Bioplastics (Berlin; www.europeanbioplastics.org) states that bio-based plastics can be recycled in the same existing streams as their petroleum-based analogs, and reiterates that sorting technologies are sophisticated enough to prevent entry into recycling streams of bioplastics for which there is no existing recycling process. For those materials, recycling streams are being researched and can be implemented at a large scale once commercial volumes of bioplastics increase, says European Bioplastics. The most serious concerns arise with so-called oxo-degradable plastics.

An oxo-degradable plastic involves special additives that contribute to its breakdown, usually via a triggered chemical reaction. When present in batches of traditional plastics intended for recycling, materials with these additives can create issues in recycling processes, if the degradation reaction is triggered, and can also compromise the service-life integrity of recycled end products. According to the European Plastic Converters (Brussels Belgium; [20 CHEMICAL ENGINEERING WWW.CHE.COM MARCH 2014](http://www.plastic-</p></div><div data-bbox=)

sconverters.eu) trade association, even in volumes as small as 2%, degradable plastics can be significantly detrimental to the quality of recycled materials. This is especially concerning in the case of recycled materials intended to be used for long-lifetime end products, such as HDPE pipes or geotextiles used for highway construction, because the risk for degradation creates liability. Part of the problem is a lack of transparency, says APR's technical director, David Cornell, as plastics with degrading additives are not readily identified as containing the additives. "Plastics recyclers do not know if a given package contains the additives or not and are reluctant to knowingly use a category of packaging known to include the additives," says Cornell. He goes on to explain that the APR provides testing guidelines and protocols for companies who produce polyethylene, polypropylene and PET with degradable additives. The intent is to give companies the ability to evaluate the feasibility of using their products for certain recycled applications. European Bioplastics concurs, also emphasizing the importance of adequate labeling for bioplastics and degradable plastics for recycling purposes. Nonetheless, alternative plastics with biological or degradable characteristics will be an important piece of the plastics industry, and recyclers and manufacturers will likely need to work together toward feasible end-of-life solutions.

Looking ahead

While there are an increasing number of new processes for recycling polymers, the reality is that a majority of recyclable materials still end up in landfills or get incinerated, due to logistical or geographical issues, lack of awareness and a lack of appropriate, readily available processing facilities. Plastics Europe (Brussels, Belgium; www.plasticseurope.org), a trade association representing Europe's plastics industry, has embarked on an ongoing project called "Zero

Plastics to Landfill." As the name suggests, this ambitious project aims to completely banish plastics waste from European landfills by 2020. Obviously, as plastics manufacturing and consumption continues, this challenge will fall mainly in the hands of recycling companies. New innovations and support

for recycling will be needed. The technologies and processes covered here are just a small portion of the recycling capability in the industry today. Companies will continue find innovative ways take advantage of these abundant and valuable waste feedstocks. ■

Mary Page Bailey







WE'RE ENHANCING THE

ELEMENTS

OF STRENGTH.



Corzan® Industrial Systems get their strength from our science. That's because The Lubrizol Corporation's superior CPVC compounds create every Corzan pipe and fitting. With the power of mechanical strength and corrosion resistance, Corzan pipe and fittings exceed the demands of industrial and commercial applications. Plus, every Corzan system has delivered **MORE INSIDE™** for more than 20 years — giving you access to Lubrizol's unmatched R&D, technical expertise, global capabilities and a network of customers who are industry-leading manufacturers.

Enhance the strength of your next industrial job. Visit corzancpvc.com or call a piping systems consultant at 1.855.735.1431.





Follow us on Twitter
@LZ_CPVC



© 2014 The Lubrizol Corporation, all rights reserved. All marks are the property of The Lubrizol Corporation. The Lubrizol Corporation is a Berkshire Hathaway company. GC 121100

SENSORS SAVE THE DAY

New and improved sensors support chemical processing applications in a multitude of ways



FIGURE 1. GF Piping's Signet 2734-2736 pH and ORP electrodes contain an embedded memory chip, which will store the probe calibration, allowing the user to calibrate in the laboratory and install in the field

The chemical processing industries (CPI) rely heavily upon the use of sensors to measure everything from weight to temperature to pH to pressure. Because sensors are used for measurements that affect critical processing elements, such as quality, efficiency and safety, it is important that sensors be placed almost everywhere in the facility, including in highly corrosive environments. Also, sensor readings from these and other operations must remain stable and reliable. Knowing this, sensor manufacturers continue to make improvements to their technologies so that chemical processors can have confidence that the sensors, as well as their operations, will not fail.

Smarter sensors for reliability

Keeping a system running reliably is one of the biggest challenges faced by chemical processors. And, depending on the sensing technology, regular maintenance and calibrations can consume a lot of time. However, if not done regularly, a bad batch or product can be the result. "This is especially true in the case of pH and ORP (oxidation reduction potential), where the electrodes are consumable devices, requiring periodic cleaning and calibration in order to provide stable and reliable process readings for proper control," says David Voltaire, instrumentation product manager with GF Piping Systems (Tustin, Calif.; www.gfps.com).

For this reason, he says, smarter sensors are being developed that

can give the operator an indication of any potential issues that may arise between maintenance and calibration procedures.

"In the case of pH sensors and electrodes, they are now being outfitted with such technology," says Voltaire. Self-diagnostics will detect broken glass and high glass impedance, alerting the operator to probe failure or maintenance needs. Built-in memory chips will allow for calibration of electrodes in laboratory or other settings and installation of pre-calibrated probes in the field, reducing system downtime and cumbersome use of buffers and cleaning solutions in the process environment. Memory-chip-enabled electrodes can also store operational data, such as minimum and maximum pH/mV readings, runtime and minimum/maximum temperature for troubleshooting and operations evaluation.

For example, GF Piping's Signet 2751 pH/ORP Advanced Sensor Electronics featuring the DryLoc connector offers realtime monitoring of the health of the pH electrode. In conjunction with the 9900 SmartPro Transmitter, the 2751 will detect broken glass and high glass impedance, alerting the operator to probe failure or maintenance needs.

The company's Signet 2734-2736 pH and ORP Electrodes feature a patented reference-electrode design and use the DryLoc connector. The large-area PTFE reference junction, salt bridge and reference electrode

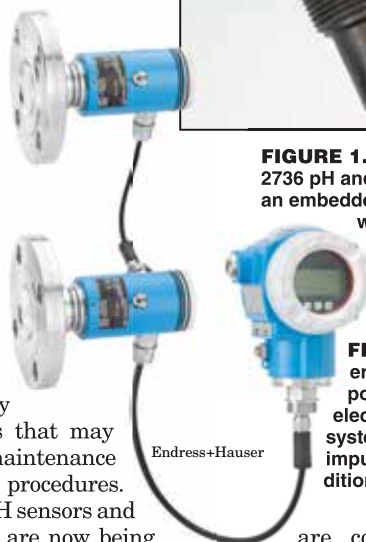
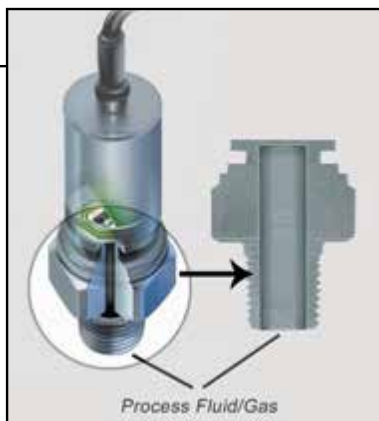

FIGURE 2. Endress + Hauser's FMD71 and FMD72 loop-powered, 4-20-mA HART electronic differential pressure systems eliminate errors from impulse tubing and provide additional sensor diagnostics

are constructed to increase the total reference effectiveness, resist chemical attack, and ensure long service life. The electrodes contain an embedded memory chip, which will store the probe calibration, allowing the user to calibrate in the laboratory and install in the field. The memory chip will record the electrode runtime, minimum and maximum readings for evaluation of performance over extended time periods (Figure 1).

Craig McIntyre, chemical industry manager with Endress+Hauser, Inc. (Greenwood, Ind.; www.us.endress.com), adds that quality and trust of the measurement information is a related challenge. "As increased process reliability and control improvements are sought, the demands for more precise and trustworthy measurement information from sensors increase," he says.

"Vendors are driven to design in not only physical sensor reliability improvements, but also calibration/verification and sensor information-qualification improvements, both inside the sensors themselves and also in companion sensor performance management tools," McIntyre continues. "For example, sensor improvements and available data are supporting sensor calibration and



American Sensor Technologies

FIGURE 3. American Sensor Technologies uses the thickest Hastelloy diaphragm and a low-operating strain to create a sensor that offers long-term pressure measurement

performance verification programs that enable process improvement initiatives that did not previously have the means to ensure necessary measurement quality and trust.”

For example, Endress+Hauser’s FMD71 and FMD72 loop-powered, 4–20-mA HART electronic differential pressure systems (Figure 2) eliminate errors from impulse tubing and provide additional sensor diagnostics that can be accessed through an FDT standards-based tool (like FieldCare), and integrated and managed in something like Endress+Hauser’s W@M Life Cycle Management Portal environment.

The FieldCare tool allows access to the information in an asset management system via mobile devices, meaning that from the field, a technician can call up the calibration history, diagnostic data, troubleshooting instruction and other information needed to properly diagnose a device problem.

Advanced sensor materials

Another challenge faced by chemical processors is finding sensors that can stand up to the corrosive materials found in the process environment. Liquid and gas compatibility and potential contamination are one of the more difficult issues they deal with, says Greg Montrose, marketing manager with American Sensor Technologies, Inc. (Mt. Olive, N.J.; www.astensors.com). “Certain sensor technologies are limited in the material that can be used or the method in which it is sealed,” he says. “For example, ceramic pressure sensors are clamped to a metal process connection with an O-ring seal. While ceramic has good compatibility with various liquids and gases, O-rings need to be selected carefully and considered in the com-

patibility process. O-rings may also have a limitation in temperature.”

For this reason, he says, there is a trend to move toward Hastelloy C276 sensor material in chemical processing. “It has a good combination of media compatibility and material strength,” says Montrose. “With the presence of hydrogen sulfide and chlorides in many chemical processes, nickel alloys offer higher survivability than standard stainless steels.” AST uses the thickest Hastelloy diaphragm (Figure 3) and a low-operating strain to create a sensor that offers long-term pressure measurement. With the diaphragm being the thinnest and most critical piece of a pressure transducer, a thicker diaphragm ensures it will withstand a long-term installation.

Using Krystal Bond Technology, AST designs pressure sensors as a monolithic piece of material with no welds, O-rings or fluid fills. Bulk silicon strain gages are mounted directly to the top of the metal diaphragm using a special glass firing process. With high raw output signal, inorganic materials and a thick diaphragm membrane, users benefit from complete isolation of the pressure of the fitting and long-term stability.

According to Endress+Hauser’s McIntyre, ceramic materials are increasingly finding use in place of metals in chemical applications. For example, ceramics that approach the purity of sapphire are being used in pressure, differential-pressure and, now, electronic differential-pressure sensors to address chemical corrosion, abrasion, vacuum, shock and stability challenges in place of traditional exotic metals and sensor constructions.

And on the horizon, according to Bob Karschnia, vice president of wireless with Emerson Process Management (Austin, Tex.; www.emerson.com), is a series of coatings of nanomaterials that can be used to help prevent corrosive problems. “Today we have different materials like Hastelloy, gold and stainless steel, depending on the process, but



GLOBAL EXPERTISE IN AUTOMATION

Electric actuators for industrial valve automation

Reliable, powerful, efficient. AUMA offer a large portfolio of actuator and gearbox type ranges.

- Automating all types of industrial valves in all market segments
- Integration into all commonly used control systems
- High corrosion protection
- Service worldwide



Learn more about our automation solutions

www.auma.com

auma
50 years in motion!

Circle 5 on p. 68 or go to adlinks.che.com/50974-05

SEPARATION ANXIETY?™

YOU CAN RELAX.

Pentair designs and manufactures high performance separation and filtration technologies that help chemical plants with:

- Filtration & Separation
- Purification
- Protection
- Recovery and Reuse
- Conditioning
- Treatment

Call today to speak to someone about achieving results that will save you more time and money than ever before.

1.888.896.6300
1.936.788.1000

www.pentairseparations.com

 **PENTAIR**

Circle 30 on p. 68 or go to adlinks.che.com/50974-30

Newsfront



FIGURE 4. The Rosemount 708 Wireless Acoustic Transmitter & Steam Trap Monitor provides acoustic event detection, including leaks in steam traps and pressure relief valves

there might be clever ways to look at nanomaterials as a single coating that would solve all the problems in a variety of applications,” he says. “This would not only prevent the problems associated with corrosion, but it would also reduce inventory for the plant and reduce human error in the form of someone choosing the wrong sensor material for an application.”

Karschnia says Emerson is in the process of working with these types of coatings to figure out how to use them correctly so they function as Emerson would like them to in the process plant.

Wireless sensors

While wireless sensors and the benefits they provide — such as reduced cabling and labor costs and the ability to monitor remote locations — have been around for some time in the process industry, Karschnia says the use of wireless sensors is still growing dramatically. “Six years ago wireless sensors might have been used in a greenfield plant in niche applications, but now 30 to 40% of all I/O on a new project is wireless and many of these are new applications where sensors previously might not have been used at all,” he says.

As a matter of fact, industry is coming up with new types of wireless sensors that help solve problems that might have been ignored in the past. For example, Emerson’s Rosemount 708 Wireless Acoustic Transmitter & Steam Trap Monitor (Figure 4) provides acoustic event detection, including leaks in steam



FIGURE 5. Mettler Toledo’s WMC Ultra Compact High Precision Weigh Module has a width of 1 in.

traps and pressure relief valves. The transmitter communicates acoustic level and temperature, as well as device and event status via the WirelessHART network for integration into host systems, data historians or energy management software.

“Prior to this sensor, there was no way to determine whether steam traps were working, other than via a manual process,” explains Karschnia. “The sensors can tell you if they’re failed open and you’re wasting energy, or failed closed and likely to damage equipment due to water hammer.”

He says Emerson developed this sensor, and others like it, for what they are calling “pervasive sensing applications,” which are new sensors coupled with strategic interpretation software that allow users to solve problems they haven’t been able to solve in the past.

Pervasive sensing via the use of new wireless devices, according to Karschnia, leads to measurable and significant improvements in worker safety, regulatory compliance, equipment reliability and energy efficiency. It also provides business-critical results that are achieved with incremental investments that acquire new insight without adding complexity, while increasing profitability and productivity. And, many of the solutions address essential asset-monitoring capabilities, gas leaks, steam-trap monitoring, safety-shower monitoring, mobile-worker and operator-round reductions that can help processors realize positive results.

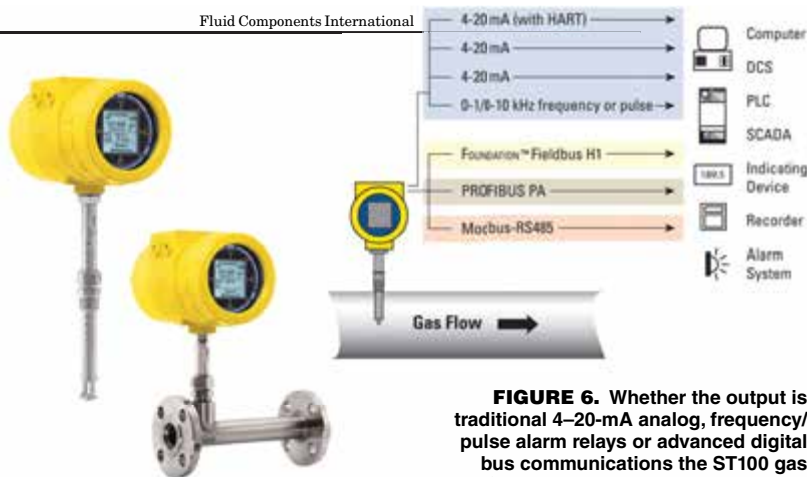

FIGURE 6. Whether the output is traditional 4–20-mA analog, frequency/pulse alarm relays or advanced digital bus communications the ST100 gas flow meter can be converted to any of these outputs with a simple card change, right in the field

Smaller sensors

While miniaturization of sensors may not be a priority in the chemical industry because most of the processes have enough room, there are several applications where smaller sensors with very high resolution may come in handy. For example, Mettler Toledo recently launched its WMC Ultra Compact High Precision Weigh Module, which has a width of 1 in. and features 2 million divisions (Figure 5). The stainless-steel design and the built-in overload protection ensure performance, and it interfaces to a variety of automation buses like Ethernet/IP or ProfiNet IO for high-speed data processing. It is suitable for check weighing and automated sample preparation, as well as fast and precise filling of active pharmaceutical ingredients (APIs).

Jeff Holcomb, marketing manager for Industrial Automation with Mettler Toledo (Naenikon, Switzerland; www.mt.com/apw) says the module is also being used in applications that wouldn't have been considered for measurements before. "In the semiconductor industry, they use a print head to build up some of the materials, and now they can use this sensor to count the drops that come out of the print head as a method of calibration, which adds a quality step into the process. Also, it can be used in various coating processes to ensure that the right amount is being applied," he says. "These applications are ideal because the sensor is small and highly accurate, which allows it to be built easily into a machine. Analog sensors this size exist, but experience much higher measurement uncertainty."

Communication flexibility

Often in process plants there is difficulty in making the transition from a traditional analog communication protocol to a digital communication protocol, says Randy Brown, marketing manager with Fluid Components International (FCI; San Marcos, Calif.; www.fluidcomponents.com). "It is a huge investment to swap from a traditional analog output control system to a digital-based protocol. This expense is made even more significant when the current instruments become obsolete and processors have to start over with new instruments that support the digital protocol they've selected," says Brown. "But, if an instrument were interchangeable between multiple protocols just by switching the I/O card, that would go a long way toward making digital less expensive."

With that thought in mind, FCI introduced the ST100 Series, including the ST100 gas flowmeter (Figure 6), to meet current and future needs for outputs, process information and communications. Whether the output is traditional 4–20-mA analog, frequency/pulse alarm relays or advanced digital bus communications such as HART, Foundation FieldBus, Profibus or Modbus, the ST100 can be converted to any of these outputs with a simple card change, right in the field, says Brown. "This also ensures that if you decide to switch back to analog for any reason, you can keep the instrumentation system and just switch out the cards, once again." ■

Joy LePree



Waste to money

for example:

**Sludge drying
Glycol recovery
Used oil recovery
Lubricant recycling**



GIG KARASEK
Distillation · Evaporation · Drying

www.gigkarasek.com

Circle 19 on p. 68 or go to adlinks.che.com/50974-19

FOCUS ON

Safety Equipment

Safety glove for broader industrial use

This company has harnessed an advanced knowledge of yarn technology to create an affordable and innovative glove, allowing a broader industrial market of workers to benefit from premium safety solutions. The Dexterity Ultrafine 18-Gauge Cut-Resistant Glove (photo) is said to be incredibly dexterous, allowing a sleeker fit and improved finger dexterity to allow workers to complete precise tasks requiring agility. The gloves are made with DuPont Kevlar fiber, which combines high dexterity and cut-resistance to keep workers safe while performing tasks that require ultra-lightweight protection. — *Superior Glove Works, Acton, Ont., Canada*
www.superiorglove.com

Hands-free lighting for safety of first responders

Trellchem encapsulating gastight suits are used by a variety of responders in emergency situations, where the environment can be both very dangerous and most often very demanding in terms of lighting. This company recently introduced the Trelchem Hands-Free Visor Light System (photo), which offers first responders a built-in, hands-free LED lighting solution, designed to offer improved visibility and a safer working environment for any first responder, including hazmat, chemical, fire, police and military. With this new, integrated, lightweight lighting solution, the responder can focus on the mission without having the hands tied up by carrying a separate torch. — *Ansell, Iselin, N.J.*
www.ansell.com

This shield protects against high-pressure gage leaks

Safe View Shields (photo) are used on armored-glass liquid-level gages to protect nearby operators from high-pressure leaks — a rare but



Ansell



Clark-Reliance



Superior Glove Works

potentially dangerous situation. The shields are easily retrofitted to the company's Jerguson-brand level gages, as well as on similar gages from other vendors. The shields are made of Lexan polycarbonate, and are available in lengths to fit most flat-glass gage styles. — *Clark-Reliance Corp., Strongsville, Ohio*

www.clark-reliance.com

A cover to seal off drains in the event of a spill

The Pig Rapid Response Drain-blocker Drain Cover (photo) is designed to deliver affordable emergency response protection in spill-prone areas near drains. Packaged in an easy-to-open high-visibility storage tube, the Drain Cover's super-sealing urethane bottom creates a tight seal to seal both floor and storm drains during spill emergencies, both indoors and outdoors. The Drain Cover features an



Newpig

ultraviolet-resistant polypropylene top layer that will not stretch or tear when picked up. The covers are available in four sizes for square or round drains from 9 to 36 in. — *New Pig Corp., Tipton, Pa.*
www.newpig.com

Manage dust-explosion risks with safe indoor venting

The Q-Rohr-3 family of products (photo, p. 28) is an indoor flameless-

IS CORROSION YOUR WEAKEST LINK?

NOV Fiber Glass Systems leads the world in supplying piping systems to a multitude of applications and service conditions within the chemical and industrial marketplace. Whether centrifugally cast or filament wound, epoxy or vinyl ester, we have the product and process to provide a fit-for-purpose system for every need.

Our pipes and fittings address a broad range of service demands, from transferring water to handling concentrated chemical solutions and abrasive materials. When conditions involve elevated temperatures or pressures, our pipes manufactured with thermosetting resins meet the challenge.

Go to www.fgspipe.com to learn more.



Focus

venting system that eliminates the need for relocating dust collectors or other enclosures outside. The Q-Rohr-3 consists of a specialized stainless-steel mesh construction and the company's rupture disc. An integrated signaling unit connects to any audible or visual alarm and shutdown to alert plant personnel, should there be an incident. In an event, flames are extinguished, and pressure, noise and dust are reduced to negligible levels. The device is FM and ATEX approved, NFPA compliant, and is approved for use with dusts (including metal dists), gases and hybrid mixtures. — *Rembe, Inc., Charlotte, N.C.*

www.rembe.us

Eliminate downtime in critical applications with this module

The PS3500 Diagnostic Module (photo) continuously monitors the health and efficiency of PS3500



Pepperl+Fuchs

power supplies and primary side power conditions. The module provides realtime diagnostics with configurable warning and alarm levels, and alerts maintenance and operations personnel to irregularities, faults and impending failures. This promotes proactive maintenance to help eliminate unexpected and expensive downtime. The power-supply diagnostic module is modular and "hot-swappable," and easily integrates into plant asset-management systems through RS485/HART, EDDL or FDT/DTM technologies. — *Pepperl+Fuchs, Twinsburg, Ohio*

www.pepperl-fuchs.us



Rembe

New workbench to configure safety applications faster

The AADvance Workbench 2.0 was recently introduced to help manufacturers get process-safety applications up and running faster. Ideally suited for applications that require a flexible architecture, distributed safety and mixed safety integrity levels (SILs), the AADvance Workbench is a complete design, configuration and maintenance software environment. The system consists of the scalable AADvance controller platform configured to any mix of SIL1 to SIL3 simplex, redundant or triplicated safety loops. Several

KRAL

■■■■■ Pumps

Screw Pumps With Magnetic Coupling. The Solution for PUR Manufacturer.

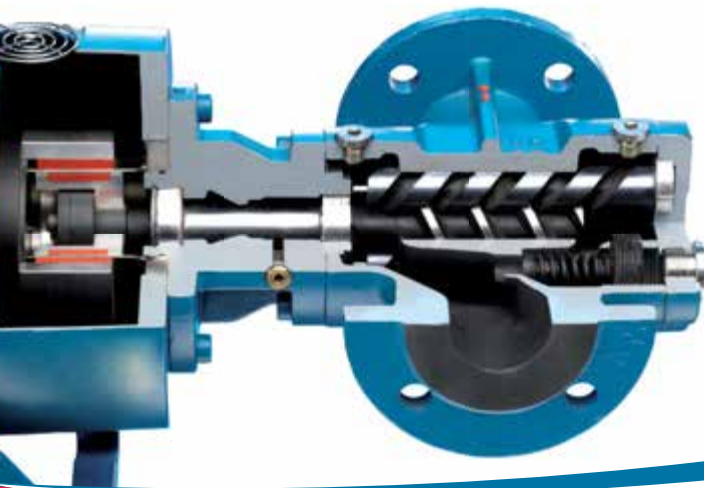

No more problems with mechanical seals.

Polyol is highly viscous at low temperatures and puts an enormous load on a mechanical seal. This means that the seal constantly needs replacing.

A magnetic coupling is a lasting remedy.



Now it's Madagascar!



Madagascar, a country better known for Disney movies about it and its spectacular natural diversity, is now home to another thing it can be proud of – cooling towers from Paharpur. Paharpur has supplied and erected two 4-cell timber crossflow cooling towers – of capacities 12,950 CMH and 13,685 CMH – for the acid plant and power plant of a nickel-cobalt plant – of production capacity 60,000 TPA nickel and 5,600 TPA cobalt – in this beautiful African country.

The first cooling tower Paharpur exported was way back in 1969... a small cooling tower for the central air-conditioning

plant of a luxury hotel in Singapore. Since then, hundreds of Paharpur cooling towers have been exported to more than 50 countries on 5 continents for such diverse applications as giant fertiliser plants, power plants, petroleum refineries, paper mills, sugar plants, edible oil plants, steel mills, chemical and petrochemical plants, textile mills and central air-conditioning plants of hotels, shopping malls, hospitals, offices, schools, airports, metro stations and the like.

But, in spite of all this, when a country is added to Paharpur's world, it's a special occasion.



Your Full-Service Cooling Technologies Company
www.paharpur.com

Paharpur Cooling Towers Ltd, Paharpur House, 8/1/B Diamond Harbour Road, Kolkata - 700 027, INDIA
Phone : +91-33-4013 3000 • Fax : +91-33-4013 3499 • pctccu@paharpur.com
PAHARPUR USA, Inc. Suite 135, 18300 East 71st Avenue Denver, CO 80249, USA • Phone : +1-303-989 7200
Fax : +1-720-962 8400 • info@paharpurusa.com

AIR-COOLED HEAT EXCHANGERS

COOLING TOWERS

AIR-COOLED STEAM CONDENSERS



Focus

units can be used to form a network of distributed safety controllers seamlessly integrated to monitor and control thousands of safety I/O points. A system is configured using the workbench software to suit any functional-safety or critical-control application using a standard range of modules and assemblies. It is

particularly well-suited to emergency shutdowns and protection applications for fire-and-gas detection by providing a system solution with integrated and distributed fault tolerance. — *Rockwell Automation Inc., Milwaukee, Wis.*
www.rockwellautomation.com



This SIS now has ISASecure EDSA certification

This company recently obtained the ISASecure Embedded Device Security Assurance (EDSA) certification for its ProSafe-RS safety instrumented system (SIS; photo). The ISASecure program was developed by the ISA Security Compliance Institute with the goal of accelerating the industry-wide improvement of cyber security for industrial automation and control systems. The ISASecure EDSA certification has three elements: communication robustness testing, functional security assessment, and software development security assessment, and is based on the IEC 62443-4 standard. — *Yokogawa Corp. of America, Sugar Land, Tex.*
www.yokogawa.com/us

Software to speed safety system engineering and design

To address the challenge of designing safety systems, this company recently introduced SafeGuard Profiler software, a design and analysis tool that speeds and simplifies safety system engineering and design. SafeGuard Profiler is a safety integrity level (SIL) lifecycle tool that gives process automation professionals the information and the power they need to conduct successful engineering failure analysis, SIL determination, SIL verification/validation (SIL-V), SIL optimization and other related tasks. SafeGuard Profiler provides a two-pronged approach to analysis of safety systems and processes, using a LOPA (Layer of Protection Analysis) module and a SIL-V software module for designing and evaluating SIL-rated systems. The two modules work together to help improve and maintain process plant applications at all stages of development. — *ACM Facility Safety, Calgary, Alberta, Canada*

www.safeguardprofiler.com ■

Gerald Ondrey

Oil & Gas and Chemical Processing Filtration & Separations Conference



March 25-26, 2014 • Houston Marriott Westchase, Texas

Make plans to attend the largest filtration and separation technical conference in the U.S.

Visit <http://spring.afssociety.org/> for more information.

Plenary Sessions (include, but not limited to):

Nature-Inspired Gemimetic Filtration Membranes for Chemical Processing Filtration – Prof. Kuo-Lun (Allan Tung), National Taiwan University, Taipei, Taiwan

Gas Monetization: How are We Doing? – Doug Heguy – Principal, Process Technology Marketing

An Overview of the Situation, Development and Opportunity of China Filtration and Separation – Prof. Qixin Zhu, Tianjin University, Tianjin, China and Dr. Lihong Du, Shanghai Institute of Chemical Industry

Technical Sessions (include but not limited to):

Produced Water Processing

Filtration & Separation in Chemical Processing

Modeling and Simulations

Chemical Assisted Separations

Natural Gas/NGL Treating

Adsorption and Absorption

Coalescing

Filtration and Separation Short Courses

www.afssociety.org

Circle 4 on p. 68 or go to adlinks.che.com/50974-04

MARCH New Products



Mass-Vac

Protect vacuum pumps from contamination with these traps

These vacuum inlet traps (photo) protect pumps across many applications, from laboratory settings to scalable production systems. The inlet vacuum traps feature user-selectable filter elements for removing the corrosive gases and abrasive particles created by processes that use volatile organic compounds (VOCs). Designed for simple inline installation and filter changes, these traps are available in a wide range of sizes for protecting all types of vacuum pumps from fluid contamination. Suitable for capacities from 1 to 5,000 ft³/min, these vacuum inlet traps are made from stainless steel, with diameters ranging from 4 to 16 in. Various filter elements and materials are available. — *Mass-Vac, Inc., North Billerica, Mass.*
www.massvac.com

These fume exhaust fans have no belts or couplings

New Mono-Stack fume exhaust fans provide pollution abatement, re-entrainment prevention, odor control and energy recovery in chemical, pharmaceutical and wastewater-treatment facilities. Incorporating functional nozzle design and high plume dispersion, these fans are low-maintenance and direct-drive,



Rockwell Automation



AdvantaPure

with no belts or couplings. Mono-Stack fans are available in wheel sizes from 18 to 36 in. and airflow capacities up to 24,000 ft³/min. The fans' variable-frequency drive motors and spark-resistant construction makes them appropriate for a wide variety of applications. — *Strobic Air Corp., Harleysville, Pa.*
www.strobicair.com

Translucent tubing for peristaltic pumps in high-purity operations

APSPG tubing (photo) is specially formulated to withstand the repeated compression and release actions of peristaltic pumps and offers consistent performance in pharmaceutical, biopharmaceutical and laboratory uses. Made of platinum-cured, low-volatile-grade silicone



material, the finished tubing carries the United States Pharmacopoeia Class VI endorsement, assuring purity for fluid transfer in critical applications. Translucent for visual contact with the flowing media, the tubing operates at temperatures from -100 to 400°F and is stocked in eleven sizes, ranging from 0.031 through 0.5 in. inner diameter, with custom sizes and lengths also available. APSPG tubing can be sterilized with either gamma irradiation or autoclaving. — *AdvantaPure, Southampton, Pa.*
www.advantapure.com

This programmable controller is installed directly on-machine
The Allen-Bradley Armor Guard-Logix programmable automation

New Products



controller (PAC; photo, p. 31) can be installed directly on-machine, simplifying wiring layouts and decreasing maintenance requirements. This controller has four megabytes of internal storage space for application code and features two Ethernet/IP device-level-ring (DLR) capable connections. The Armor GuardLogix PAC provides access to the controller-mode switch, USB port, secure digital (SD) card and power-supply switch, along with 24 V d.c. power pass-through to supply power to other on-machine products. This feature allows power to be routed from one machine device or module to another, eliminating the need for a power supply for each device. Mounting tabs can be rotated vertically or horizontally. — *Rockwell Automation, Milwaukee, Wisc.*

www.rockwellautomation.com

A high-accuracy, light-weight Coriolis flowmeter

The Sitrans FC410 (photo) is a new Coriolis flowmeter that features a measuring accuracy of 0.1% of flowrate. Weighing only 10 lb, this compact meter communicates with all common process control systems and can be integrated easily into both existing and new systems. Installation and commissioning of the flowmeter require only simple, one-time configuration in the control system. If a flowmeter is moved or additional flowmeters are connected, the user settings are automatically transferred. Built-in transmitter functionalities to the sensor permit fast data transmission and flexible installation in confined spaces without the need for additional transmitters. — *Siemens Industry Sector, Erlangen, Germany*

www.siemens.com/industry

A bulk-materials conveyor with favorable space utilization

The En-Masse conveyor moves bulk materials while optimizing space utilization with its large size-to-capacity ratio. Useful in applications including boiler feed, receiving, distribution and ash handling, this conveyor's totally enclosed framework minimizes area dusting and loss of material. Capable of high-temperature operations up to 1,000°F, En-Masse conveyors are designed for harsh environments and can be ordered to meet specific plant layouts. — *CDM Systems, Inc., Kalamazoo, Mich.*

www.cdmsys.com

Mary Page Bailey

HEXOLOY[®] SILICON CARBIDE

The Name
That Makes
A World
Of Difference



No other company in the world has more expertise with silicon carbide than Saint-Gobain Ceramics. Our Hexoloy[®] sintered alpha silicon carbide is the material of choice for high performance applications in a variety of chemical processing industries throughout the worldwide market. Hexoloy components are custom made and offer excellent performance at temperatures up to 1650°C (3000°F), universal corrosion resistance, excellent wear resistance, high strength, and high thermal conductivity. Wherever you're located in the global market, specify Hexoloy silicon carbide, the name that delivers performance you can count on.

Saint-Gobain Ceramics
23 Acheson Drive
Niagara Falls, New York 14303

Telephone: 716-278-6233
Fax: 716-278-2373
scd.sales@saint-gobain.com

www.hexoloy.com

SAINT-GOBAIN
CERAMICS

Circle 37 on p. 68 or go to adlinks.che.com/50974-37

European vendors look to 2014 recovery

In December 2013, German machinery and tool orders were down 6% in real terms against the same period last year, the German engineering association **VDMA** (Frankfurt-am-Main; www.vdma.org) reported early February. Domestic business dropped by 10%, and international sales by 4%. For 2013 as a whole, growth averaged -2%. "All hopes now rest on 2014," said VDMA chief economist Ralph Wiechers.

Germany's overall manufacturing figures act as a barometer of Europe's slow economic recovery. Equipment suppliers to the chemical process industries (CPI), however, may be doing rather better.

German plastics and rubber machinery manufacturers, for instance, saw sales down by only 1% in 2013. As a result, turnover in core machinery manufacturing for this sector fell only slightly short of the most recent record of €6.5 billion.

"The result for the year is largely in line with our forecast," said Ulrich Reifenhäuser, Chairman of the VDMA Plastics and Rubber Machinery Association.

Although domestic demand remains sluggish, exports in this sector rose by 4.1% in the period to November 2013 compared to the previous year, close to a new record of €4.6 billion.

"Our top sales markets are proving very strong: China is more than making up for

last year's dip in growth and the U.S. is also growing faster than average. The major South Asian markets – India, Indonesia and Thailand – are experiencing a pause in growth. Within the EU, our members' reports confirm the rates of growth in exports to Italy, Spain and Portugal," Reifenhäuser said.

As a result, the VDMA believes German sales of plastics and rubber machinery will grow by 6%, to €6.9 billion, in 2014.

Supporting EU objectives

In January, the VDMA welcomed the European Commission's proposal for an EU-wide target to cut greenhouse gas emissions by 40% by 2030.

"The Commission has sent an important signal that investment in eco-friendly technologies will continue to pay off in the future," said Holger Kunze, Director of VDMA's European Office. "In climate policy ... what we do not do today, we will have to catch up in a few years, at higher cost."

But the organization rejected the idea of a rigid target – as at present – for renewable energy, and wants reform of the European emissions trading scheme (ETS) delayed until 2021, claiming short-term intervention would undermine trust in the market.

The VDMA also supports a plan by the Commission to restore industry's share of

Inside

Alexanderwerk	321-14
AUMA Riester	321-6
Berndorf Band/Steel Belt Systems	321-12
BEUMER Maschinenfabrik	321-9
Bronkhorst High-Tech	321-14
Donadon SDD	321-10
Frewitt	321-8
GEA Process Engineering	321-3
GEA Wiegand	321-15
GIG Karasek	321-8
Italvacuum	321-13
KRAL	321-10
MICRODYN-NADIR	321-8
Müller	321-13
Pepperl + Fuchs	321-15
PHOENIX CONTACT	321-11
Pompetravini	321-4
SAMSON	321-12
Sandvik Materials Technology	321-4
Sandvik Process Systems	321-6
ThyssenKrupp Industrial Solutions	321-2

GDP to 20%, from its current (and falling) level of 15%. Advanced manufacturing technologies and Germany's "Industry 4.0" concept for intelligent factories could help, the organization notes. ■

YOUR VACUUM DRYING SPECIALIST

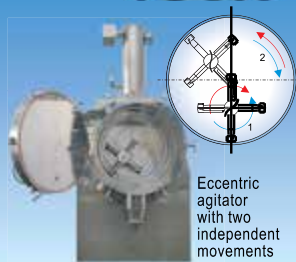

Eccentric agitator with two independent movements

Planex
System

Patented paddle vacuum dryer



CRIOX
System

Patented rotary vacuum dryer/powderer



MULTISPRAY
SYSTEM

Vacuum tray dryer with extractable shelves



Saurus
939

Vacuum pump LubriZero®



Via Stroppiana 3 - Borgaro (Turin) Italy - Tel. + 39 011 4704651
marketing@italvacuum.com - www.italvacuum.com



Alexanderwerk

Alexanderwerk – Modern symbiosis from tradition and innovation!



WP 120 Pharma

Laboratory and pilot production machine for the pharmaceutical industry

- throughput of 8 to 40 kg/h in a continuous operation
- two-stage granulation in Diagonal-Design®
- rollers in cantilever design
- non-metallic parts FDA-approved
- URS-conformity as required
- tool free disassembly made completely of high quality stainless steel
- easy and accurate scale-up
- mobile machine base
- consistent separation between process material and technical equipment

www.alexanderwerk.com | +49 (0)2191 795 0

Circle 3 on p. 68 or go to adlinks.che.com/50974-03

Mass Flow Controllers

For accurate process gas control in (petro)chemical industry



RUGGED for harsh environments
PROVEN thermal mass flow technology
ADAPTIVE digital (RS232 Fieldbus) communication

Innovation - Experience - Responsibility

HANNOVER
MESSE
7-11 April 2014
Hall 11
Booth A42

Bronkhorst®
 HIGH-TECH

I www.bronkhorst.com - E Sales@bronkhorst.com

Engineering Excellence³

ThyssenKrupp Industrial Solutions brings together three global players



Large-scale integrated propylene/polypropylene complex for EPPC in Port Said, Egypt, using the Uhde-STAR process for the oxydehydrogenation of propane

ThyssenKrupp Industrial Solutions now offers the consolidated power of Engineering Excellence³. This new company is the combination of ThyssenKrupp Fördertechnik, ThyssenKrupp Polysius, and ThyssenKrupp Uhde, each of which was already a global player in its own right before they were merged.

ThyssenKrupp Industrial Solutions is pooling its plant construction expertise in the Process Technologies and Resource Technologies Business Units, in order to continue expanding the EPC business. The fields of expertise are highly varied and include the planning and construction of chemical plants, refineries, cement works and other industrial complexes as well as advanced technologies for mining, mineral processing, and port handling systems.

ThyssenKrupp Industrial Solutions is a company with decades of experience in large-scale plant construction as well as mechanical engineering. The company assists its customers throughout all stages of their projects, from the initial idea to market studies, facility design, construction, shipment, assembly, turnkey commissioning, and all the way to after-sales service.

ThyssenKrupp Industrial Solutions is present wherever its customers have a need, anywhere in the world. This results in excellent global market expertise combined with profound local know-how. As a consequence the company can apply its knowledge to offer clients holistic solutions in plant engineering and construction. ThyssenKrupp Industrial Solutions successfully employs not only its own advanced systems and methods, but also the process technologies of other licensors. Depending on the job at hand, Industrial Solutions combines individual elements into a package customized to the individual needs of its customers.

With more than 70 branches and around 19,000 employees, ThyssenKrupp Industrial Solutions is present throughout the world. The regional structure allows the range of services to be tailored to suit the situation in specific regions.

ThyssenKrupp Industrial Solutions has a portfolio of unique breadth. The company's engineers and technicians are continually developing trendsetting solutions that help customers gain a competitive edge. Having built thousands of plants, ThyssenKrupp possesses competence that is outstanding in the world.

www.thyssenkrupp-industrial-solutions.com

Circle 9 on p. 68 or go to adlinks.che.com/50974-09
 321-2 CHEMICAL ENGINEERING WWW.CHE.COM MARCH 2014



We know
what makes a
**GOOD
POWDER**

To make superior powders, look for a GEA Niro drying system. We specialise in supplying industrial drying systems designed to match your exact product and plant specifications, and with more than 10,000 references worldwide our expertise is unsurpassed. Our comprehensive product range includes GEA Niro spray dryers, fluid bed systems, spray congealers and the SWIRL FLUIDIZER™. At our extensive test facilities, the most experienced test engineers and process technologists in the business will help you move rapidly from idea to product development and profitable production.



GEA Process Engineering A/S

Gladsaxevej 305, DK-2860 Soeborg, Denmark
Tel: +45 39 54 54 54, Fax: +45 39 54 58 00
gea-niro.chemical@gea.com, www.gea.com

engineering for a better world

Circle 17 on p. 68 or go to adlinks.che.com/50974-17

GEA Process Engineering

A full range of corrosion-resistant alloys on show

Sandvik Materials is using a U.S. exhibition to promote its portfolio of materials that allow heat exchanger, hydraulic and instrument tubes to withstand harsh conditions

Sandvik Materials Technology will present its advanced corrosion-resistant alloys including duplex, super-duplex and hyper-duplex



stainless steels at the NACE Foundation's CORROSION 2014 exhibition in San Antonio, Tex., 9–13 March (booth number 1339).

"NACE 2014 is an invaluable occasion for us to connect with industry professionals and demonstrate our ability to address critical corrosion resistance issues which lead to material failure, plant breakdowns and costly lost production time," said Magnus

Brodin, Sandvik Group Sales Development Manager. "Our full portfolio of corrosion-resistant alloys offer extreme resistance to corrosion caused by chlorides, aggressive chemicals and media in varied applications."

Sandvik says its material grades have demonstrably superior corrosion resistance in the kinds of harsh environments experienced by hydraulic and instrumentation as well as heat exchanger tubing, over standard steel grades like AS 316 and 316L. Products displayed at CORROSION 2014 include umbilicals, hydraulic and

instrumentation tubes, coiled workover tubing, composite tubes, finned tubes and thermocouples.

In industry corrosion tests, Sandvik SAF 2507 proved to be one of the best materials for replacing 316L for hydraulic and instrumentation tubing in offshore platforms. The super-duplex stainless steel has very high resistance to pitting and crevice corrosion, with excellent resistance to stress corrosion cracking in chloride-bearing environments.

Sanicro 28, a high-alloy austenitic stainless steel for demanding conditions, exhibits superior resistance to pitting and crevice corrosion, while the nickel alloy Sanicro 41 provides improved resistance to acidic media such as sulfuric acid.

Brodin added: "Materials like Sandvik 3R60 Urea Grade, a high-purity variant of AS 316L with a low ferrite content for greater resistance to general, intergranular and pitting and crevice corrosion, are crucial in helping our customers achieve today's cost efficiencies, higher output and reduced maintenance." www.smt.sandvik.com

Compressor and vacuum packages move into focus

Pompetravaini Group is expanding its activity in engineered pump packages to address a market that is growing – and becoming increasingly demanding

Following its takeover in 2012 of the Swiss company NSB Gas Processing, pump specialist **Pompetravaini Group** has been forging ahead in the world of engineered packages. Pompetravaini-NSB now offers a wide range of engineered packages based around vacuum pumps, compressors and Roots vacuum boosters.

NSB provides skid-mounted pump systems for industries ranging from pharmaceuticals and chemicals up to large flare gas recovery units for the oil and gas sector. These are sold under trademarks including Apovac, Combivac, and Aporec. Pompetravaini Italy, meanwhile, offers its Hydrosys, Oilsys and Hydrotwin packaged units, and Travaini Pumps USA markets the Dynaseal and Evo lines.

Packaged units in general are increasing in importance, Pompetravaini says, and becoming more sophisticated in terms of customization and specific engineering practices. To stay abreast of these developments, the Pompetravaini Group is reinforcing its engineering and project management structure.

Every Pompetravaini unit now accepts requests for quotations for complex packages based on liquid-ring vacuum pumps, compressors, ejectors, and vacuum boosters, either singly or in combination. Pompetravaini engineers design and build packages to customers' specifications, including full documentation on materials, components, instrumentation and so on.

Pompetravaini has been always known for fast and reliable service, from initial selection to aftersales and spare parts. A worldwide network of operations allows the group to serve customers in



This two-stage liquid-ring compressor handles 2,500 m³/h of flare gas at 7.5 bar. Skid-mounted packages like this form an increasingly important business area for the Pompetravaini Group.

almost every country. 85 years in business testify to the long life of Pompetravaini products and to the continuing availability of spares and service for many years to come. The Pompetravaini motto is "Committed to stay ahead" and the strengthening of the engineering package side confirms this. www.pompetravaini.com

We Connect the Field to Your Control Room

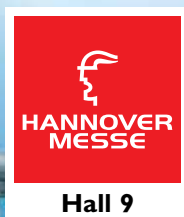

Hall 9

Solutions for the chemical, oil and gas industry

Phoenix Contact is a leading supplier to the process industry. We offer a broad product range of industrial connection technology, Ex-i isolators, surge protection, interfaces and Ethernet systems to help you connect sensors and actuators to the control room. Many of our products can be used in potentially explosive areas and safety-related applications. Our global sales network of 40 subsidiaries and more than 30 sales representatives guarantees close proximity to the customer.

For additional information call
+49 52 35 3-00 or visit
phoenixcontact.com

 **PHOENIX
CONTACT**
INSPIRING INNOVATIONS

Explosion-proof actuators

AUMA extends its product range with new part-turn actuators for hazardous areas



AUMA's explosion-proof electric actuators include the new part-turn SQEx .2 (foreground) and multi-turn SAEx .2

AUMA's range of modular electric actuators, gearboxes and controls includes the new SQEx .2 part-turn actuator, an explosion-proof version of the SQ actuator introduced at the start of 2013.

The SQEx .2 meets the ATEX and IECEx standards for hazardous areas and will be submitted for certification in additional countries including Russia, the U.S., Japan and Canada.

An explosion-proof SQEx version for modulating duty provides enhanced positioning accuracy and allows more starts per hour.

Christoph Edelmann, a Product Manager for AUMA, says: "The response from our customers to the SQ range has been very positive and the new actuators have already been successfully deployed in major projects around the world."

Designed for butterfly and ball valve automation, the SQ and SQEx ranges replace AUMA's established SG and SGExC actuators. Compared with their predecessor products, the new series offers a significantly wider torque range (50–2,400 Nm) and new functionality for diagnostics and asset management.

Commissioning and operation of SQEx actuators are identical to the SAEx multi-turn product line. Both ranges are available with simple AMExC or micro-controller-operated ACEXC integral controls; the two control types are interchangeable.

www.auma.com

Flexibility for fertilizers

Sandvik pastillation technology underlies this process for added-value fertilizers

Solutions from **Sandvik Process Systems** include complete systems for mixing, solidifying, handling and storing fertilizer products.

Sandvik's "end-to-end" fertilizer process mixes liquids with solids before converting them into uniform pastilles. This lets producers upgrade basic products such as sulfur, urea, and ammonium nitrate with important nutrients, adjusting the ratio to suit specific crops.

Blends successfully produced on this system include urea with ammonium sulfate, ammonium nitrate and its derivatives, and sulfur bentonite.

Production begins with accurate dosing and weighing of the materials to be combined, followed by mixing and, if necessary, grinding. The resulting mixture is then fed to Sandvik's Rotoform system, where it is deposited on a continuously running steel belt in the form of droplets.

The speed of the Rotoform is synchronized with the speed of the belt to create pastilles of uniform size and shape. Cooling

water sprayed underneath the belt absorbs the heat of the melt, resulting in rapid solidification of the product without contaminating the water. As the solidified pastilles reach the end of the belt they are conveyed to storage or bagging.

Rotoform is a low-energy and environmentally friendly process with no visible dust emission. It produces uniform pastilles with a high crushing strength, in sizes of 1–5 mm. Each Rotoform line has a typical capacity of 120–150 m.t./d, depending on the product, and production can be scaled up by running multiple lines.

www.processsystems.sandvik.com

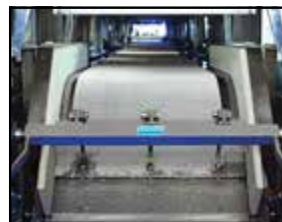

Continuous production of pastilles the Sandvik way

INTELLIGENT FIELDBUS KEEPS YOUR PROCESS RUNNING



FieldConnex

Future Technology For More Availability

- Advanced Diagnostic Gateway with I/Os for the control cabinet
- Segment Protectors with progressive fault isolation
- Diagnostic-enabled surge protector with DCS connection – no repetitive checks
- Leakage sensors for guaranteed water-proof installation

Fieldbus with intelligent diagnostics: www.pepperl-fuchs.com/intelligent-fieldbus

PEPPERL+FUCHS
PROTECTING YOUR PROCESS



Hall 9
Booth D76

Circle 31 on p. 68 or go to adlinks.che.com/50974-31

INGENIOUS INDUSTRIAL PUMP SOLUTIONS. CREATED FROM BRAIN POWER

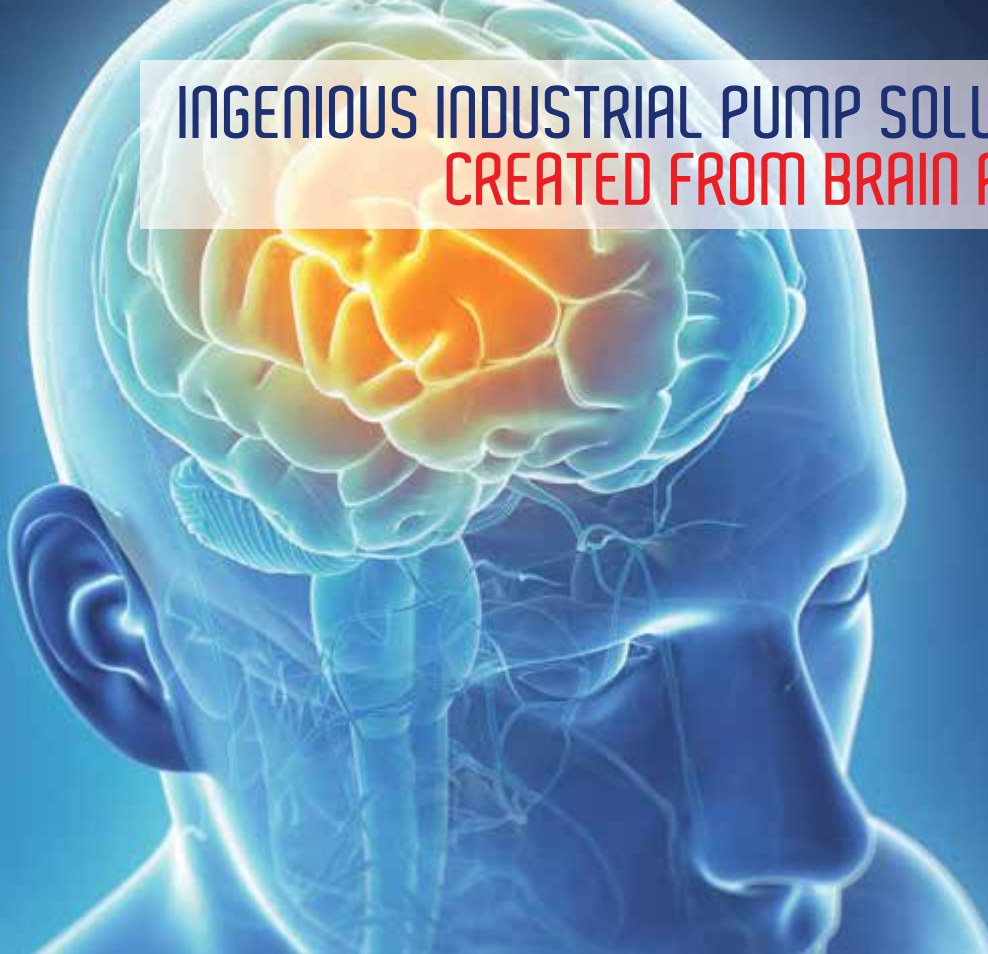

We work with **HEART, MIND** and **BODY**, because we are **PEOPLE**
PEOPLE serving **PEOPLE**, with **PASSION, INTELLIGENCE** and **COMMITMENT**
that's why we are able to offer **SOLUTION PACKAGES, NOT JUST PUMPS**

- ✓ Design for excellence
- ✓ Personalized guidance in the pump selection process
- ✓ Fast response and delivery
- ✓ Long term after market support
- ✓ Trained service and spare parts available worldwide



pompetravaini
Committed to stay ahead

www.pompetravaini.it



Pompetravaini Spa Via per Turbigo, 44 • 20022 Castano Primo (Mi) • Tel. +39.0331.889000 • Fax +39.0331.889057
vendite@pompetravaini.it • www.pompetravaini.it

Circle 33 on p. 68 or go to adlinks.che.com/50974-33

New Austrian-U.S. partnership

Long-time collaborators GIG Karasek and InCon set up a joint venture in thermal separation technology

GIG Karasek of Austria and the U.S. company InCon Processing have signed an agreement to establish a joint venture as a platform for the production and distribution of thermal separation technology equipment. InCon has been GIG Karasek's U.S. partner for more than a decade.

The new company, which will be known as GIG Karasek LLC, will

be headquartered in St. Charles, Ill. Its president is Hugh Palmer, formerly general manager at InCon Processing. "This collaboration combines InCon's experience in the field of high vacuum distillation and tolling business with GIG Karasek's technical expertise and established market presence," Palmer said.

The joint venture will focus on the development and supply of thin-film and short-path evaporator equipment and systems for customers in the Americas, which are reported to be one of the most important markets for this type of equipment.

"Our objective is to keep and further strengthen our leading position in the target markets worldwide. With GIG Karasek LLC, we are well positioned to ensure profitable growth and long-term success in our markets. And the most important issue is that we are now much closer to our customers and so are able to give them optimal service," said Gerhard Högl, sales and marketing director at GIG Karasek GmbH.

www.gigkarasek.com



The U.S. market for thin-film and short-path evaporators is strong, reports GIG Karasek

The experts in membranes

Fine filtration is a specialty of MICRODYN-NADIR



The flat membranes of BIO-CEL bioreactor modules achieve high packing densities

MICRODYN-NADIR GmbH, with locations in Europe, Asia and the U.S., is the leading independent manufacturer of micro, ultra and nanofiltration membranes and modules. The firm points out that since membranes will remain its core competence in the future, it carries out intensive research and development activities in this field at its Wiesbaden location.

For more than 45 years MICRODYN-NADIR products have been used in various industrial and municipal applications, including integrated processes as well as water and wastewater treatment. The membranes' outstandingly sharp cut-offs and reproducibility have proved their worth in the chemical and pharmaceutical industries.

One of the firm's most innovative products is the immersed BIO-CEL module for membrane bioreactors. This backwashable module combines the advantages of flat membranes with the packing density of hollow-fibre modules, creating many application possibilities in municipal and industrial wastewater treatment.

BIO-CEL membrane modules can also be cleaned mechanically through the use of the BIO-CEL-MCP (mechanical cleaning process), helping to reduce operating costs and energy requirements.

www.microdyn-nadir.de

3-in-1 mill saves costs and time

A modular approach to size reduction brings flexibility, functionality and cost-effectiveness, says Frewitt

A new 3-in-1 modular milling system brings lower cost of ownership and accelerates return on investment in the pharmaceutical, chemical and food industries, claims size reduction specialist **Frewitt**. The company's new FreDrive offers a choice of milling and screening processes in a single machine.

Frewitt engineers combined three existing pieces of equipment: a medium-speed conical sieve mill, a lower-speed cylindrical sieve mill, and a high-speed hammer mill. These field-proven components are essentially unchanged in the FreDrive.

What has been changed is the drive arm, which connects the drive and control system with the milling components both electronically and mechanically. The control and operator interface design was completely reworked to ensure automation control with each milling head.

Customers equipped with the three interchangeable mill heads can change easily between grinding, fine grinding, and controlled screening of powders and



Modular milling equipment is flexible and lower in cost than individual items

granules, according to the demands of the process. They will benefit from faster production and product changeovers; easier assembly and disassembly of screens and rotors; increased process reliability; low maintenance; and easy scale-up.

The modular system is not only ergonomically friendly, but also cost-effective. In the past, operators needing a range of size-reduction techniques were forced to invest in three separate mills. With the FreDrive system, investment is 50% less for the same functionalities.

www.frewitt.com

Solutions for palletizing, packaging, and filling

Built to suit the application, BEUMER machines are efficient and productive



The BEUMER stretch hood packaging machine secures goods on the pallet, minimizes film consumption and protects the product

The product range of intralogistics specialist **BEUMER** includes fillpac bag filling machines, paletpac high-performance layer palletizers, and stretch hood high-performance packaging machines. BEUMER also offers modules for fully automatic product feed, supply of empty pallets, and transportation of loaded pallets.

The BEUMER fillpac R bag filling machine is designed for capacities of 300–6,000 bags per hour. It can process all kinds of bags, including HDPE. An enlarged filling impeller permits faster filling. The three-position cylinder, which controls coarse and fine feed, is protected against dust as it is located vertically and outside the contaminated area. The bag discharge cylinder is also situated in the dust-free area above the filling spout. An automatic bag weight correction system adjusts the weights of subsequent bags.

The BEUMER paletpac high-performance layer palletizer stacks paper, PE and PP bags on pallets of all common sizes accurately and stably. Depending on the product requirements, the turning device is a bar, clamp, or double-belt system which brings the filled bags quickly and gently into the required position.

The robotpac is a space-saving, fully automatic articulated robot which is able to perform complex palletizing and depalletizing tasks reliably and efficiently. Containers such as bags, cartons, boxes, canisters and trays can be stacked safely and economically. BEUMER has developed appropriate, flexibly exchangeable gripper systems for every packaged product.

The BEUMER stretch hood high-performance packaging machine (photo) packages these stacked bags quickly, reliably and permanently with stretch films in a number of thicknesses. The high-quality film protects goods against weather, dust, moisture, and mechanical impact, even outdoors.

The BEUMER Group is an international leader in intralogistics systems for conveying, loading, palletizing, packaging, sortation and distribution technology. Together with Crisplant a/s and Enexco Teknologies India Limited, the BEUMER Group employs about 3,500 people and has a turnover of about €512 million. With its subsidiaries and sales agencies, the BEUMER Group is present in many industries the world over.

www.beumergroup.com

the new technology is here



THE NEW

IS **ano** **Scored**

RUPTURE DISC

The first high performance rupture disc manufactured with the newest technology



FIND OUT OUR NEW RUPTURE DISCS!

SCR/IS - SCD/IS - Y90/IS

△ Maximum Precision △ Absolute Reproducibility

△ Material Flexibility △ Design Flexibility

donadon SDD
SAFETY DISCS AND DEVICES



Address: Via Franceschelli, 7 - 20011 Corbetta (MI) - ITALY

P: +39 02 9011001

F: +39 02 90112210

donadonsdd@donadonsdd.com

Circle 11 on p. 68 or go to adlinks.che.com/50974-11

www.donadon.com

Pumps optimize polyurethane production

KRAL pumps use a screw principle to convey raw materials gently and consistently, with significant benefits for product quality during polyurethane manufacture

The quality of polyurethane made by continuous polymerization depends strongly on the consistent delivery of raw materials to the mixing head, notes pump and flowmeter manufacturer **KRAL**. The company's screw pumps can significantly improve polyurethane product quality and production reliability

ity by conveying monomers and additives in a gentle and controlled way.

The screw spindle pumping principle employed by KRAL pumps minimizes turbulence, shear, and temperature rise in the fluids being transferred.

The pumps also operate quietly, with little pulsation or vibration to disturb the fluid.

All these characteristics mean that KRAL pumps provide a steady flowrate of materials to the mixing head, while fluid properties

such as viscosity remain unchanged. As a result, the polymerization reaction can be strictly controlled to maintain the quality of the finished polyurethane.

Gear pumps, in contrast, have the disadvantage that the liquid is exposed to high shear forces and crushing at the gear wheels as they intermesh. This damages the polymer chains, which is why gear pumps are operated at low speeds. KRAL screw pumps are gentle on the media they deliver, even at high speeds, ensuring that the power density is efficiently high.

Magnetic coupling is a reliable technology that ensures a hermetic seal, eliminating contact between the fluid and the environment. This has advantages especially with sensitive components such as isocyanates, which react with atmospheric oxygen. KRAL pumps with their magnetic couplings also avoid the need for flushing liquids, which are generally required to avoid the development of abrasive crystallization on mechanical seal faces. Critical fluid media remain inside the pump and are not exposed to the environment. The benefit is maintenance-free operation, with high operational safety and long service life.

www.kral.at/en/

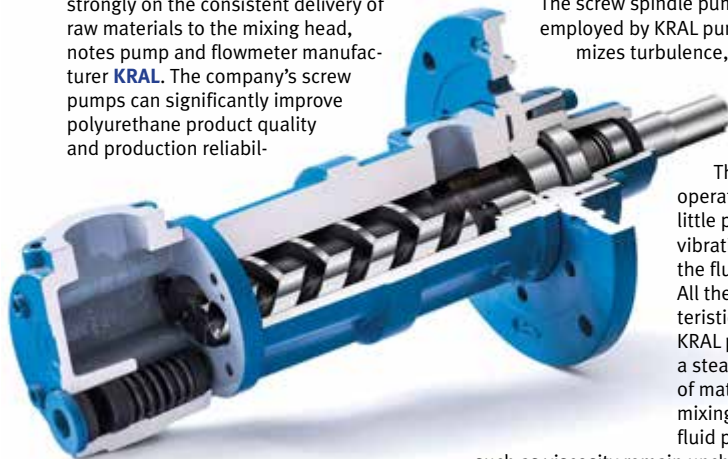

The screw pumping principle used in KRAL pumps delivers polyurethane components gently, ensuring optimum product quality

Scored rupture discs are precise and versatile

A fully laser-based manufacturing process brings a unique set of advantages to the new NS NanoScored series of rupture discs from Donadon SDD

A fully laser-based process to manufacture rupture discs has been demonstrated for the first time by **Donadon Safety Discs and Devices** (Donadon SDD) for its new NS NanoScored discs. The breakthrough process means that NS NanoScored discs are the first to combine:

- high precision over the full range of burst pressures;
- absolute reproducibility, because there is no tool wear during manufacturing;
- design flexibility: NS NanoScored discs are available in forward-acting and reverse-buckling designs, with a choice of either radial or circular opening;
- material flexibility: stainless steel, nickel, Hastelloy, Inconel, Monel, titanium, and tantalum;
- resistance to fragmentation, even at high burst pressures; and
- very low burst pressures – below 0.5 bar g (7 psig) – are available in full metal discs.

Donadon SCD (forward acting) and SCR (reverse buckling) discs with micro-scored sectors – six or more sectors compared to the usual four – offer advantages including more complete opening and reduced risk of petal detachment, even at very high burst pressures. These rupture disc models are especially suited for protection of pressure relief valves and offer good resistance to corrosion and high temperatures. NS NanoScored rupture discs are very well suited for application in pharmaceutical, food and biotech industries, for plants with clean-in-place and steam-in-place technology,



NS NanoScored rupture discs have many advantages

and GMP production. Donadon NS rupture discs can be installed in clamp-type connectors and are made entirely of metal (stainless steel or other alloys according to customer specifications). Very important for many applications is the availability of vacuum-resistant discs with rupture pressures below 0.5 barg (7 psig). All products are tested in compliance with the Pressure Equipment Directive and ATEX, and the company is certified to ISO 9001:2008. Donadon SDD is also approved to the KTA 1401 standard as a supplier of rupture discs to nuclear power plants. www.donadonsdd.com

Signal conditioners are compact and pluggable

The Mini Analog Pro family from Phoenix Contact is ideal for confined spaces



The Fastcon Pro plugs used with the Mini Analog Pro range can be inserted or removed easily under field conditions, and everything is accessible from the front of the unit

Mini Analog Pro from Phoenix Contact is the first family of signal conditioners with a width of 6 mm that features pluggable connection technology. The Fastcon Pro connector plugs can be inserted and pulled independently of each other even when bundled with many devices. The signal conditioners are easy to install in compact spaces, and thanks to their design, all connection and operating elements are easily accessible from the front. Wiring can be done in any order via screw-type connectors, or quickly and without tools via push-in technology. The mounting rail bus connector also provides for quick energy bridging.

At startup and during service, only one measurement is needed to capture the entire current loop from sensor to controller without isolating the loop. Signal and supply circuits can be quickly interrupted during startup and service using the system's built-in isolation function.

Large labeling areas offer ample space for complete loop marking despite the devices' compact design. Status LEDs in every signal conditioner ensure quick and continuous diagnosis as well as group error logging via the mounting rail bus connector. From simple DIP switch configuration to advanced configuration via software or smartphone app, the signal conditioners can be parameterized very flexibly. The smartphone app takes advantage of wireless near field communication (NFC) to eliminate the need for accessories.

Modern transmitter technology and electrical isolation to withstand a 3 kV test voltage ensure high signal quality. The extended supply voltage range of 9.6–30 V DC and the broad operating temperature range from –40 to +70°C cater to a wide range of applications. At present, the product family includes universal signal conditioners, temperature and potentiometer transducers, as well as standard signal conditioners.

Phoenix Contact has complete ownership of the product chain: the complete development process, production of every metal and plastic part, its own SMT manufacturing, and all assembly in one place. The result is short delivery times and high levels of quality and reliability.

www.phoenixcontact.com

Endless steel belt systems for the chemical & petrochemical industry



What Bear discovered:

SBS Steel Belt Systems designs and builds continuous conveyors for a wide range of applications, equipped with steel belts from Berndorf Band.

Having been pioneers in the development of pastillating units, SBS now provides turnkey solutions along with cooling conveyors for the solidification of liquid sulphur into pastilles.

Rolldrop® and **Accudrop®** are registered trademarks of SBS Steel Belt Systems.



SBS Steel Belt Systems s.r.l.
I-21040 Venegono Inferiore, Italy
Phone: (+39)0331/864841
Fax: (+39)0331/864959
info@steelbeltsystems.it

Detailed information at
www.steelbeltsystems.com

Partner of



Where innovation is tradition

SAMSON is a world-leading supplier of control valves to the chemical process industries

SAMSON is a name recognized worldwide as a synonym for high-quality work, entrepreneurial spirit and innovative strength. The company's field of expertise extends from heating and air-conditioning to the largest chemical plants. SAMSON operates wherever there is controlled flow of vapors, gases, or liquids.

Since 1916, the manufacturing plant and head office have been located on the river Main in Frankfurt, Germany. Here product development and manufacturing take place, as well as administration and warehousing. The Frankfurt headquarters and the affiliated companies employ and train over 3,800 people, whose loyalty to the company stems from their sound working environment. The management team, progressive yet traditional, is committed to the SAMSON name and the technical competence and partnership it stands for.

For over 100 years SAMSON has developed and manufactured control equipment for industrial processes. From rugged self-operated regulators to highly specialized

control valves for industrial processes, the broad product range includes valves to meet all requirements. The key products are control valves, which SAMSON manufactures in all common sizes, in standard materials and exotic alloys, equipped with actuators tailor-made for the specific demands of the application. Among accessories, SAMSON positioners set the standards with their reliability, accuracy and versatility. They communicate using all common protocols and bus systems, and integrate seamlessly into current process control systems. Most of the control valves and accessories are developed and manufactured at SAMSON's headquarters; in-house manufacturing ensures highest product quality and reliability.

SAMSON's Type 3730-6 positioner with pressure sensors sets standards in cost-effectiveness, flexibility and reliability. Its features include:

- one positioner for throttling and on/off applications;
- integrated EXPERTplus diagnostics;

- TROVIS-VIEW 4 software for configuration and operation free of charge;
- HART communication with free EDDL and FDT/DTM;
- monitoring of the entire operating cycle with EXPERTplus valve diagnostics;
- integrated sensors to monitor supply pressure and signal pressure;
- automated partial stroke test (PST) suitable for safety-instrumented systems up to SIL 3.

www.samson.de, www.samsongroup.de



Type 3241-7 pneumatic control valve with Type 3730-6 electro-pneumatic positioner

A creative partnership in pastillation technology

Italian company SBS Steel Belt Systems works with Berndorf Band of Austria to create robust, dust-free pastillation systems for sulfur and other chemical products

SBS Steel Belt Systems S.r.l. is an Italian company, founded in 1984, which produces steel belt machinery and turnkey plants for a wide range of industries: chemical, petrochemical, food, rubber, and powder coatings.

SBS is a partner of the multinational Berndorf Band Group, whose headquarters are in Austria. SBS itself is located in Venegono Inferiore (Varese), a small town close to Milan's Malpensa airport.

SBS Steel Belt Systems S.r.l. Italy and its partner SBS Steel Belt Systems Inc. USA have pioneered the development of pastillating units for a wide range of products.

In recent years SBS has moved into sulfur solidification technology, providing several oil refineries and gas fields with turnkey solutions complete with:

- liquid sulfur pumps;
- liquid sulfur piping;
- water cooling systems;
- sulfur solidification units equipped with continuous Berndorf steel belts;
- solid sulfur belt collectors;



Refinery sulfur: a common application for SBS and Berndorf Band pastillation equipment

- solid sulfur silos;
- bagging equipment; and
- solid sulfur truck loaders.

The SBS pastillation head, known as ACCUDROP, has recently been upgraded through the use of a very effective rotating outer shell. With its high pipe wall thickness and innovative drilling pattern, ACCUDROP now has the ability to produce pastilles with a diameter of around 4 mm, better spherical shape, and higher mechanical strength.

These characteristics help to reduce a well-known problem in the pastillation industry: the creation of dust. Caused by abrasion during handling of the product (for instance in packing, unpacking, loading, and unloading), dust formation is influenced by the properties of the product. Small, smooth and strong pastilles produce only a negligible amount of dust, thus resulting in an eco-friendly product.

The combination of an ACCUDROP pastillation head and a Berndorf steel belt provides an efficient and secure process. Excellent flatness of the belt and regular service from both SBS Steel Belt Systems and Berndorf Band ensure long operating life and lower maintenance costs.

In recent years SBS has collaborated with some of the largest engineering and construction companies to supply refineries in southern Italy, Spain, Serbia, Turkey, Russia, Indonesia, Saudi Arabia, Qatar, Jordan and many other countries all over the world.

www.berndorf-band.at
www.steelbeltsystems.it

Handling is key to production

Müller provides reliable, ergonomic and cost-effective solutions for container handling in pharma and food



Müller lifting equipment in action

Handling systems are one of the key factors in process economics. Whatever the industry – pharmaceuticals, chemicals, or food – effective production depends on

quality handling equipment that performs well and above all is safe and reliable. Müller handling equipment offers all these qualities. With over 30 years of accumulated experience, the company designs, develops and manufactures everything itself. Customers can therefore count on world-class solutions to meet the most demanding needs.

Müller customers worldwide appreciate the company's innovative engineering, for example the slender lifting column which ensures a good view of the drum or container. All Müller lifters use electro-mechanical drives for low-maintenance, cost-effective, safe, ergonomic and quiet operation. Typical tasks include feeding machines like tablet presses, capsule filling machines, and blister packers. Maximum repeatability for all travel positions makes Müller lifting columns the perfect choice especially when working with split valve systems. Customers can choose between relay control or programmable logic controllers (PLCs). www.mueller-gmbh.com

Cutting-edge vacuum drying

ITALVACUUM's Planex System ensures effective drying of even the most sensitive pharmaceutical materials

ITALVACUUM, one of the best-known European manufacturers of vacuum dryers and vacuum pumps, recently introduced a new horizontal paddle vacuum dryer. The Planex System is especially suitable for the production of active pharmaceutical ingredients, fine chemicals and intermediates.

The innovative Planex System has a fixed cylindrical chamber with an eccentric agitator that rotates independently on its own axis and also tangentially to the chamber wall. This double rotation provides optimal mixing with continuous surface renewal to aid the release of solvent vapors. Drying times are significantly reduced compared to conventional systems, the company says.

The relatively small diameter of the agitator reduces mechanical and thermal stresses compared to traditional paddle dryers. This prevents local overheating due to friction, eliminates any risk of product contamination, saves power, and allows the Planex System to treat delicate and heat-sensitive products without risk of damage. The narrow gap between the agitator blades



The small diameter of the Planex System agitator reduces thermal stress without compromising drying performance

and the chamber wall makes unloading and cleaning easy. System volumes cover the range 300–4,400 l.

ITALVACUUM also supplies auxiliary equipment for heating and cooling, vacuum pumps, condensers, filters and control systems. References include several important international chemical and pharmaceutical groups. www.italvacuum.com



Technology for a bio-based future

GEA Wiegand provides technology for isolation, purification and concentration in industrial biotech applications. As a major supplier of evaporation, cross-flow membrane filtration and rectification plants we are able to design, integrate and execute customer-specific solutions for downstream-processing of fermentation products.



GEA Process Engineering
GEA Wiegand GmbH

Phone: +49 7243 705-0
Internet: www.gea.com

engineering for a better world

Compact flow controller

Bronkhorst High-Tech of the Netherlands manufactures precise and reliable mass flow



Bronkhorst's new T23 mass flow controller, for up to 200 l_n/min

and pressure meters/controllers for laboratories, machinery, and process applications. The new T23 mass flow controller expands the company's IN-FLOW^{CTA} series. Its newly developed integrated, direct-

operating valve gives a gas flow control range of 4–200 l_n/min. The housing is sealed to IP65, and optional ATEX approval allows use in Category 3, Zone 2 hazardous areas.

These instruments work on the basis of direct through-flow measurement (no bypass), using the principle of constant-temperature anemometry. They have no moving parts and no obstructions in the flow path, which makes them ideal for low-pressure-drop applications. They are less sensitive to moisture or particulates than thermal mass flow devices which rely on a bypass sensor.

Standard I/O takes the form of analog and RS232 signals, with DeviceNet, PROFIBUS DP, Modbus and FLOW-BUS protocols available as options.

www.bronkhorst.com

Roller compactors

Alexanderwerk makes roller compactors for the pharmaceutical, chemical and other industries, and for more than 125 years the company has spent every day improving its machines. Based on the firm's experience, its innovative technologies, and the expertise of its employees, Alexanderwerk can justly claim to be a reliable partner for long-term success.

Alexanderwerk provides different solutions to support customers in producing a large range of products: textile dyes, battery compounds, fertilizers, silicic acid, feedstuffs, additives and many more.

Specific design features of Alexanderwerk roller compactors include:

- the rollers are arranged vertically, giving better control of feed flow;

- the patented two-chamber Combi-Vent-Feeder system yields better compaction;



The Alexanderwerk PP 150 C roller compactor

- two-stage granulation based on a diagonal design increases throughput by up to 100%.

www.alexanderwerk.com

The Chemical Engineering bookstore offers a variety of industry topics you will come to rely on.



- **Environmental Management: Air-Pollution Control**
- **Environmental Management: Wastewater and Groundwater Treatment**
- **Fluid Handling**
- **Gas-Solid and Liquid-Solid Separation**
- **Liquid-Liquid and Gas-Liquid Separation**
- **Managing Bulk Solids**

For a complete list of products, visit the *Chemical Engineering* bookstore now. <http://store.che.com/product/book>

**CHEMICAL
ENGINEERING**

17792

Incorporate solids without lumps

GEA Wiegand jet pumps are a reliable, low-maintenance way to move bulk solids and mix them into liquids

Mixing granular materials or other bulk solids into liquids is an important step in many process operations. Conveying and mixing must be accomplished reliably and above all without the formation of lumps.

GEA Wiegand liquid-jet solids pumps convey both fluids and granular products by means of a motive liquid which flows at high speed from a nozzle into the mixing chamber of the pump. Here it entrains the product to be conveyed, creating a uniform lump-free fluid mixture. Jet pumps can also be used within a liquid tank to provide even mixing of the complete tank contents.

Both liquid-jet solids pumps and liquid-jet mixers are of simple design and almost maintenance-free. They are easily cleaned, and suitable for CIP. Applications include:

- mixing powders into liquid in the chemical and pharmaceutical industries;
- adding fruit concentrates, sugar and other granular solids during the production of food and beverages;
- mixing carotene into edible oil during the production of food colorants; and



- creating a mash of grain and water for alcohol production.

GEA Wiegand is part of the GEA Group, which employs around 25,000 people worldwide. Sales in 2012 were more than €5.7 billion, 70% of which came from the food and energy sectors.

www.gea-wiegand.com

Analog to fieldbus – times eight

Pepperl+Fuchs FieldConnex Temperature Multi-Input ensures efficient integration with PROFIBUS PA



Temperature multiplexer for PROFIBUS PA with eight inputs for analog signals

The FieldConnex Temperature Multi-Input (TM-I) from Pepperl+Fuchs enables analog input and output signals to be connected to a fieldbus with the highest level of efficiency: in a manner that is intrinsically safe, convenient, and incurs minimal wiring costs. The FieldConnex Temperature Multi-Input is now available for PROFIBUS PA as well as FOUNDATION Fieldbus H1.

FieldConnex process interfaces can bundle signals from multiple sensors together under a single fieldbus address, thus integrating them into the digital communication system in a particularly efficient manner. In this way, the FieldConnex Temperature Multi-Input enables up to eight analog signals to be integrated into fieldbus communication. The device is mounted close to the sensors, within the hazardous area, and so saves significantly on wiring costs.

In addition to thermocouples and millivolt signals, 2-, 3-, and 4-wire resistance temperature sensors (RTDs) can be connected. All inputs on the TM-I are intrinsically safe, even if the fieldbus connection itself is not. The inputs are quick and easy to configure collectively, with individual configuration also possible. Configuration and integration into the control system is extremely convenient: for PROFIBUS PA, a GSD file and a DTM are available for download from the website.

www.pepperl-fuchs.com

MICROFILTRATION
ULTRAFILTRATION
NANOFILTRATION

IFAT Munich
May 5 - 9, 2014
Hall A2 booth no. 516
GWP Partner Booth
Hall A5 booth no. 111/210 and 112

WETEX 2014
WATER, ENERGY, TECHNOLOGY AND ENVIRONMENT EXHIBITION
Dubai, April 14 - 16, 2014



BIO-CEL®

Submerged MBR-Module for biological wastewater treatment with a selfhealing effect

- cost efficient
- high flux
- low energy demand
- easy to integrate
- backwashable
- reliable in operation
- fine-bubble aeration

MCP for BIO-CEL®

Mechanical Cleaning Process for BIO-CEL® MBR-Modules

- optimized energy consumption
- higher peak flux
- no or low demand for chemical cleaning
- process stability



MICRODYN
NADIR

ADVANCED SEPARATION TECHNOLOGIES



MICRODYN-NADIR GmbH
Kasteler Straße 45
65203 Wiesbaden / Germany
Tel. + 49 611 962 6001
info@microdynam-nadir.de

WWW.MICRODYN-NADIR.COM

Circle 24 on p. 68 or go to adlinks.che.com/50974-24

MARCH New Products

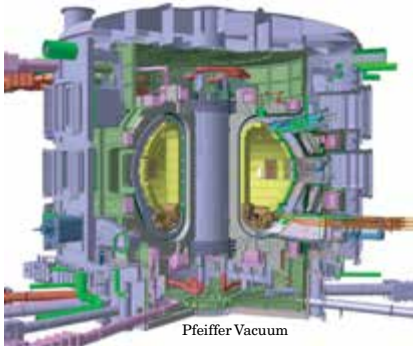

Pfeiffer Vacuum

Special vacuum pumps developed for fusion reactor

This company has been awarded a contract to develop special vacuum pumps for the ITER fusion reactor (photo) — a multinational project to further fusion power plants. In order to carry out the plasma reaction, it is necessary to evacuate the torus-shaped reactor chamber. This company is developing vacuum pumps that are designed from stainless steel and have an extremely high external leak-tightness. A new technology that has been used for the first time in vacuum pumps will also prevent the contamination of pumps' gear lubrication with the fusion fuel and vice versa. — *Pfeiffer Vacuum GmbH, Aslar, Germany*
www.pfeiffer-vacuum.com

A moisture analyzer with good connectivity

The latest models of Professional moisture analyzers (photo) from this company feature USB, Ethernet and WLAN connectivity for easy data transfer. Measurement results, displayed by an instrument on the factory floor, can be sent directly to a regular printer anywhere on the company network, for example in the quality control office. The same data may also be transferred to a file server as a PDF for on-screen viewing and electronic archiving, as well as in standard CSV or XLS format for interchange with laboratory and office software. — *Mettler-Toledo, Greifensee, Switzerland*
www.mt.com/moisture



Mettler-Toledo

Precise dosing with multi-port, fluoroplastic valve blocks

This multi-port valve block from the iComLine Series (photo) is made of ultra-pure PVDF and features innovative seat-diaphragm technology with PTFE. This combination allows very heavy-duty switching cycles and temperature resistance up to 150°C — features that are not possible with pinch valves used previously. Multi-port valve blocks combine multiple valve seats in one unit. This means that plants can now be built much more compactly, because the pipe connections, fittings and even various sensor components can be integrated together. — *GEMÜ Gebr. Müller Apparatebau GmbH & Co. KG, Ingelfingen-Criesbach, Germany*
www.gemu-group.com

Mix steam and water for safe wash-downs

The CSF Steam Water Mixer (photo) provides a reliable source of hot water that is delivered at the correct temperature and pressure. The mixer is a safe and easy-to-use device for most cleaning, or wash-down applications in just about every industry, especially in all food-and-beverage manufacturing processes. These mixers are constructed from stainless steel and are capable of delivering water up to a maximum temperature of 95°C at volumes up to 10,000 L/h. — *Pump Engineering Ltd., Littlehampton, West Sussex, U.K.*
www.pumpeng.co.uk



GEMÜ

This built-in panel PC offers multi-touch advantages

The CP22xx Built-in Panel PC series combines the advantages of a modern multi-touch interface with high-performance multi-core processors for automation and control. Equipped with multi-core CPUs — Intel Celeron, Core™ i3, i5 (all with two cores) and i7 (four cores) of the 3rd and 4th generation — the CP22xx Built-in Panel PC is said to achieve maximum computing power. Screen sizes are available in sizes from 12 to 24 in. The most demanding control and HMI (human-machine interface) tasks can be solved while precisely matching the devices to the application-specific requirements, says the company. — *Beckhoff Automation GmbH, Verl, Germany*
www.beckhoff.com ■

Gerald Ondrey

INTERPHEX

Watson-Marlow Pumps Group

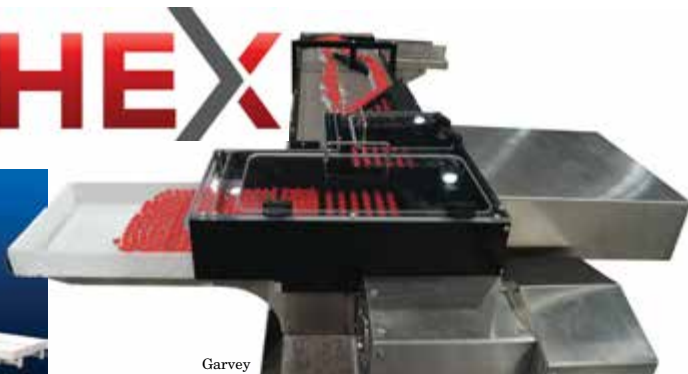

The pharmaceutical and biopharmaceutical industries will congregate March 18–20 in New York at the Jacob Javits Convention Center for Interphex 2014. The conference and exhibition will showcase products and services from over 650 exhibitors. The following is a small selection of these exhibitors' offerings at the show.

Aseptic filling solutions for a variety of applications

Flexicon aseptic filling systems (photo) provide automatic aseptic filling, plugging and capping. These highly flexible systems have integrated full- or partial-stoppering and crimp-capping of vials. The equipment features a ready-to-use and easy-to-validate filling system for small batch production for various vial sizes. Designed for use under laminar air flow, Flexicon systems can be supplied with optional restricted access barrier systems or as a customized solution for integration into an isolator. Booth 2823 — *Watson-Marlow Pumps Group, Wilmington, Mass.*
www.watson-marlow.com

An automatic tray loader that can handle 800 vials per minute

This company's new automatic multi-lane tray loader (photo) for



pharmaceutical vials can load up to 800 vials per minute into cardboard or plastic trays with very low vial-to-vial impact. Loading six rows at a time, this unit reduces the number of strokes required to load a tray, preserving vial integrity. All movements are controlled by servo-driven linear motors. The unit can be mounted to compatible accumulators, depending on line speed and vial size. Booth 3166 — *Garvey Corp., Blue Anchor, N.J.*
www.garvey.com

Reduce manual cleaning-in-place with this hygienic machine

The new Aseptic 8 tank-cleaning machine (photo) is constructed of U.S. Food & Drug Administration (FDA) compliant materials, providing a hygienic alternative to manual cleaning-in-place. The Aseptic 8 utilizes patented rotary-impingement

cleaning technology, which ensures that tanks are effectively and quickly cleaned. The amount of water, chemicals and energy required for cleaning are drastically reduced with the use of this apparatus, says the company. Created with no grease in the gear train, this fluid-driven machine operates at a wide range of pressures and flowrates and is resistant to clogging. Booth 1845 — *Gamajet, Exton, Pa.*

www.gamajet.com

When full containment is required, use these pumps

The SLS4 and SLS8 pumps (photo) are hygienic eccentric-disc pumps that are engineered for use in a wide array of applications that require full containment. The SLS4 can handle differential pressures up to 10 bars and the SLS8 can handle differential pressures up to 6 bars. High-quality machined parts give an optimum surface finish and the streamlined sealless design does not require packing or

Note: For more information, circle the 3-digit number on p. 68, or use the website designation.

Show Preview



Quattroflow

a magnetic drive. The double stainless-steel bellows ensure product containment and safety. The SLS series of pumps provides very high suction and discharge pressures, allowing them to self-prime and fully strip lines, for maximal product recovery. Booth 2633 — *Mouvex, Auxerre, France*
www.mouvex.com

These pumps feature single-use molded plastic chambers

The QF1200 Series of single-use four-piston diaphragm pumps (photo) are intended for biological-handling applications in the pharmaceutical and biotechnology industries. Featuring single-use, injection-molded pump chambers, these pumps create less waste materials. These replaceable chambers reduce downtime between batches and are simple to change out. QF1200 pumps are also convertible from single-use plastic elements to fully cleanable or sterilizable stainless-steel heads, as required by the application. The absence of mechanical seals results in linear flow characteristics and high turndown capability, allowing for safe transfer of fragile media. Booth 2633 — *Quattroflow, Kamp-Lintfort, Germany*
www.quattroflow.com

Three unique milling processes on one machine

These new modular milling systems (photo) bring together three different milling processes into one machine. The modular system is

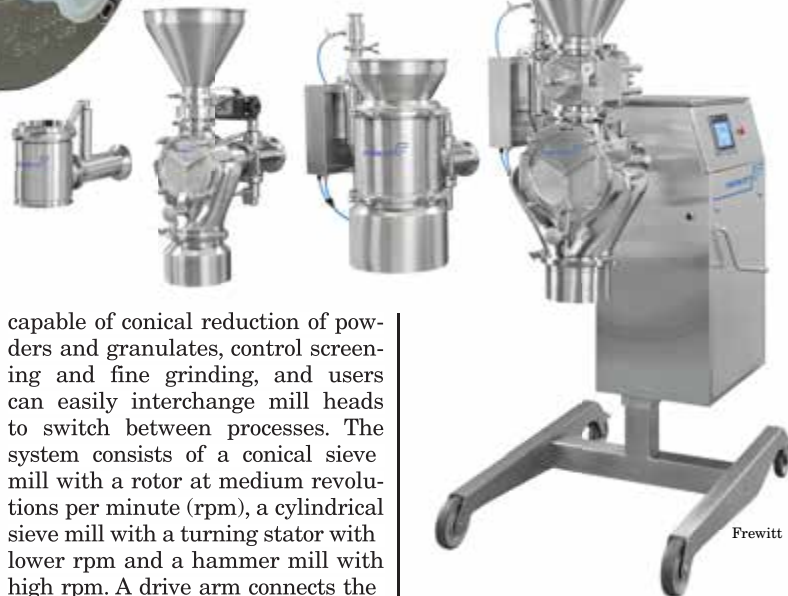

Frewitt

capable of conical reduction of powders and granulates, control screening and fine grinding, and users can easily interchange mill heads to switch between processes. The system consists of a conical sieve mill with a rotor at medium revolutions per minute (rpm), a cylindrical sieve mill with a turning stator with lower rpm and a hammer mill with high rpm. A drive arm connects the entire drive and control network to the milling system both electronically and mechanically. With an updated control and operator-interface design, the mills' programmable logic controller (PLC) can be integrated into higher-level control schemes. Booth 2140 — *Frewitt SA, Granges-Paccot, Switzerland*
www.frewitt.com

Process three container types on one machine with this system

Modular machines (photo) from this company can process nested syringes, vials and carpules, all on a single unit. Disposable systems for the various kinds of dosing pumps can be incorporated as needed, to further customize the module's flexibility. Integrated in-process monitoring results in high filling precision and batch yields. Also, batch-to-batch turnaround and idle times in machines



employing isolator barriers can be minimized. Booth 2227 — *Optima Packaging Group GmbH, Schwäebisch Hall, Germany*
www.optima-packaging-group.de

This micro-ingredient feeder has interchangeable modules

The MT-16 micro-ingredient feeder (photo, p. 35) has interchangeable feeding modules allowing for versatility between twin-screw or single-screw operation. This flexibility allows the equipment to handle a broad range of materials, including powders and granules. The overall feed capacity of the feeder is 0.02 to 27 dm³/h. The design allows for extended screw profiles, with a small footprint, resulting in closer discharge dimensions. The unit features a totally enclosed weight sensor and drive motor with high



Coperion K-Tron Pitman

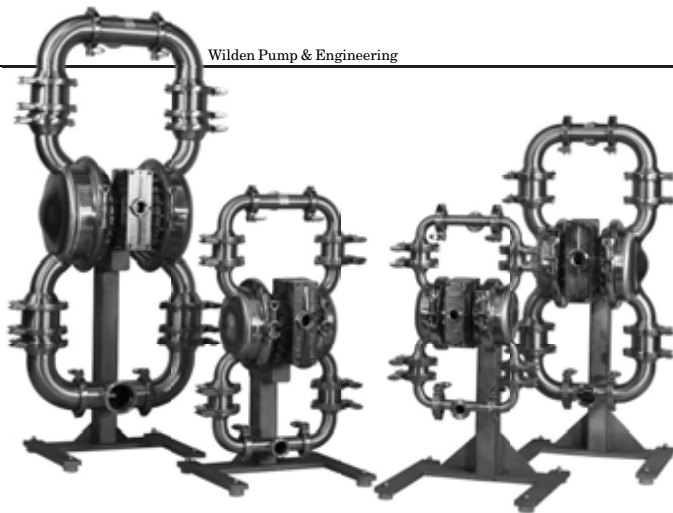

torque for handling difficult materials. The MT-16 provides accurate feeding in food, pharmaceutical and chemical processes in applications such as jet-mill feeding and continuous extrusion. Booth 2757 — *Coperion K-Tron Pitman Inc., Sewell, N.J.*

www.coperionktron.com/compact

Handle delicate products with these AODD pumps

Saniflo air-operated double-diaphragm (AODD) pumps (photo) have been specifically designed to satisfy the regulatory guidelines established by the FDA for sanitary process applications and are available with a full validation package. Saniflo pumps incorporate a straight flow-through design, and have self-priming, dry-run and dead-head capabilities. These pumps can also handle shear-sensitive products, such as cell structures and delicate polymers. The absence of mechanical seals gives full product containment and all contact surfaces are made of pharmaceutical-grade elastomers and polished 316L stainless steel. These pumps are available in five sizes from 13 to 76 mm, and feature flowrates from 58.7 to 920 L/min. Booth 2633 — *Wilden Pump & Engineering LLC, Grand Terrace, Calif.*

www.wildenpump.com

This pressure calibrator features an integrated onboard pump

The 719Pro electric pressure calibrator is a test tool designed for calibrating high-accuracy transmitters, pressure switches and pressure gages. It features an onboard electric pressure pump that can generate up to

20 bars, eliminating the need for an external handpump. This calibrator also measures, simulates and sources 4–20-mA loop-current signals and can also measure up to 30 V d.c. Its internal 24-loop power supply can power a transmitter under test conditions. Booth 3731 — *Fluke Corp., Everett, Wash.*

www.fluke.com

These abrasive cloths remove corrosion-causing debris

Abratec cleanroom abrasive cloths are designed with various levels of abrasive grit for debris removal. The cloths feature this company's Quiltec fabric, which is abrasion-resistant. Featuring sealed-border technology, the cloths can effectively remove corrosion-causing debris without contributing additional particles to the remediation process. Abratec cloths are intended to work with solvent blends typically found in sterile processing environments. Booth 1338 — *Contec Inc., Spartanburg, S.C.*

www.contecinc.com

Prevent contamination with this X-ray inspection system

The X⁵ X-ray inspection system identifies and rejects contaminants and delivers accurate product controls at line speeds of up to 394 ft/min. The rounded, sloping surfaces of the system ensure that particles and droplets cannot accumulate, unlike equipment with flat surfaces. The addition of impermeable seals to the X-ray cabinet prevent water ingress. A new tubular framework made from 304-grade stainless steel allows for operation in harsh working conditions. Contaminants such

as metals, glass, vinyl, bone, rubber, stones and ingredient clumps are automatically detected, and the packs in question are diverted from the line for investigation. Under- and over-weight packs can also be eliminated from the packing line, along with irregular and improperly packaged items and packs with incorrect content levels. Inspection data can be automatically monitored and extracted to provide an audit trail for each production run. The unit's conveyor belt features a quick-release mechanism for reduced downtime. Conveyor belts for the unit are available in widths of 300, 500 and 600 mm to suit individual requirements. Other features include a sideways-opening door to the cabinet interior, a 12-in. touchscreen and a number of cooling-system options. Booth 2776 — *Loma Systems, Farnborough, U.K.*

www.loma.com

Use these freeze-dryers for cultured or fermented materials

Atlas freeze-dryers are capable of freeze-drying materials in situations where maintaining the original structure and properties of the original product is important, such as for the handling of cultured or fermented products. Both batch and continuous processes can use these freeze-dryers, which are also appropriate for sterile operations. The dryers feature automatic control of drying cycles for each batch. Some models are built with continuous de-icing functionality to enhance drying capabilities. Booth 2421 — *GEA Process Engineering, Inc., Søborg, Denmark*

www.geap.com

Mary Page Bailey

CORROSION 2014

Collaborate. Educate. Innovate. Mitigate.



Corrosion 2014, the 69th annual meeting of the National Association of Corrosion Engineers (NACE) is taking place March 9–13 in San Antonio, Tex. More than 6,000 attendees are expected to gather in the Henry B. Gonzales Convention Center for lectures, forums, presentations and an expo hall featuring over 380 exhibitors. The following is a preview of some of the products and services that will be showcased at the event.

This new duplex alloy prevents intercrystalline corrosion

The new Ultra-Lean Duplex Centralloy G 2102 is said to have excellent corrosion resistance — especially against intercrystalline corrosion — yet is much less expensive than conventional duplex materials, according to the manufacturer. The alloy's considerably lower nickel content makes it less susceptible to highly fluctuating raw material prices, the company adds. The material can be welded using conventional consumables. The alloy is suitable for use in various areas with the most demanding requirements for wear and corrosion, such as for components in separators (decanters and centrifuges) used in the wastewater-treatment industry, as well as for pumps and process equipment in the food industry. Booth 2630 — *Schmidt + Clemens GmbH + Co. KG, Lindlar, Germany*
www.schmidt-clemens.com

Use these materials in tubing for hydraulics and instrumentation

The corrosion-resistant material grades for piping (photo) from this company are intended for use in harsh conditions, such as those experienced by tubing used in hydraulic, instrumentation and heat-exchanger applications. SAF 2507 material is an alternative to 316L stainless steel. This super-

duplex stainless steel has a high resistance to pitting and crevice corrosion, as well as to stress corrosion cracking in chloride-bearing environments. 3R60 Urea Grade is a high-purity variant of 316L stainless steel, with a low ferrite content for greater resistance to intergranular, pitting and crevice corrosion. Sanicro 41 is a nickel alloy, intended for use in acidic media. Booth 1339 — *Sandvik Materials Technology, Scranton, Pa.*
www.smt.sandvik.com

A non-destructive method to analyze and identify alloys

New positive materials-identification tools from this company use X-ray fluorescence inspection technology for the identification and analysis of various metal alloys by their chemical composition through non-destructive methods. The analyzer tools are environmentally sealed for use in dusty, dirty or wet conditions commonly found in field applications. Advanced batteries support up to 10 hours of continuous use on a single charge. A library storing data for over 400 alloys allows for use in a wide range of industrial applications. Booth 1920 — *GE Measurement & Control, Boston, Mass.*
www.ge-mcs.com

This system uses wireless technology to sense metal loss

This company's non-intrusive corrosion-monitoring systems use unique sensor technology and wireless communication to continuously monitor for metal loss from corrosion or erosion. The permanently installed systems can operate in extreme temperature environments and inaccessible locations, making them ideal for large-scale deployment in many upstream and downstream applications. Corrosion-monitoring solutions enable risk-based deci-

sion-making to increase throughputs, extend run lengths and allow for safe processing of low-quality feeds. Booth 1504 — *Permasense Ltd., Horsham, U.K.*
www.permasense.com

A coating that protects against very strong acids

SewerGard Industrial No. 210GN coating is used to protect concrete or steel from chemical attack in industrial wastewater applications. Featuring high resistance to strong acids — even sulfuric acid concentrations as high as 98% — this coating is specifically formulated as a sealer in strongly oxidizing environments. SewerGard Industrial No. 210GN can be applied by either spray or roller. Booth 2528 — *Sauereisen, Pittsburgh, Pa.*
www.sauereisen.com

Detect corrosion in vessels and pipes, even under insulation

The GridStation 8200 is a corrosion-imaging system, which in customer trials, has successfully detected corrosion in piping and vessels through jacketed insulation and fireproofing materials. The system applies a low-frequency magnetic-field methodology for realtime imaging of both internal and external corrosion, with defect sizing and automated reporting capabilities. In addition to corrosion imaging, the GridStation 8200 enables stress-corrosion crack mapping and crack-depth measurement. Booth 1302 — *Jentek Sensors Inc., Waltham, Mass.*
www.jenteksensors.com ■

Mary Page Bailey

Effective level measurement in the chemical process industries (CPI) helps maintain material inventory at economic quantities, improves product quality and maximizes plant output by avoiding spills and process upsets. When they are incorrectly matched to their application, level-measurement devices can contribute to lower quality and poorer process consistency. No single level-measurement technology is suitable for all applications. This column provides information about level measurement technologies and guidance for choosing the most accurate and effective device for an application.

Technology approaches

The technology used by level measurement devices can broadly be divided in multiple ways. One method is to think about them as point-level versus continuous-monitoring devices, and another way is to classify them as either contact or non-contact devices.

Point versus continuous. Point-level detection is mainly conducted by liquid-level switches. These switches or liquid-level gages are designed for controlling the maximum or minimum liquid level allowed in a container. Point-level detection is inexpensive, because it uses mechanical switches or simple gages. Continuous level sensing is used when it is necessary to know the specific level at all times. This information can be important when transferring liquids, mixing or determining product levels.

Contact versus non-contact. Placing the level sensor in contact with the material being measured presents potential challenges having to do with corrosion, pH level and other environmental factors. Foaming, dust, tank pressure or steam can limit the use of non-contacting devices. For some applications, both types can be used.

Key questions

The following application-related questions should be considered when selecting a level-measurement device:

- What types of material(s) will the sensor be exposed to?
- Are solids or liquids being measured?
- Will the level sensor be placed on the internal or external surface of the tank or vessel?
- What temperatures and pressures will the sensor experience?
- What is the density of the material to be measured?
- Does the operation require multiple sensors?
- Does the sensor need to comply with any specific design codes?
- In liquid-level measurement, what is the boiling or flash point?
- What level of precision is desired or required for the measurement?
- Is there steam present in the tank or vessel where the measurement is taken?
- What is the size of the tank or process vessel?
- Is the material being measured corrosive or highly viscous?
- Does the material being measured contain suspended solids?
- Does the material change state with varying temperature or pressure?
- Are any reactive or hazardous substances present in the material to be measured?
- What level alerts need to be transmitted from the sensor?
- What software and hardware are required to integrate the level measurement sensor into the operation?

Table 1 includes several technologies used in level-measurement devices, while Table 2 outlines some of the specific CPI applications for which the technologies are used.

TABLE 2. AN OVERVIEW OF LEVEL-MEASUREMENT TECHNOLOGIES AND SUITABLE APPLICATIONS

Technology	Application
Ultrasonic	Chemical storage tanks
	Wastewater effluent
	Plastic pellets
Radar	Chemical bulk-storage vessels
	Sulfur storage
	Agitated process vessels
	Reactor/process vessels
Guided wave radar	Liquid storage
	Plastic pellets
	Slurries
	Displacer replacement
Capacitance	Styrene and other aromatic compounds
	Acids, caustics
	Adhesives
	PVC pellets
	Interface in agricultural chemical production
Electro-mechanical	Plastic pellets
	Carbon black
	Fertilizer
	Styrofoam beads and chips

References

1. Schmidt, K., Level Measurement Technologies for the CPI. *Chem. Eng.*, July 2008, pp. 34–37.
2. Schaffer, C., Vessel Sizing and Level Instrumentation. *Chem. Eng.*, February 2012, pp. 30–34.
3. Aiken, L., Liquid Level Measurement Options for the CPI. *Chem. Eng.*, July 2008, pp. 38–42.

Editor's note: Portions of this month's "Facts at your Fingertips" column were contributed by Brian Sullivan, sales manager at Valin Corp. (San Jose, Calif.; www.valin.com). Other content was adapted from articles noted in the references.

TABLE 1. LEVEL-MEASUREMENT DEVICES: ADVANTAGES AND DISADVANTAGES

Technology	Advantages	Limitations
Mechanical floats are low-density floats mounted on a horizontal arm connected to a switch	<ul style="list-style-type: none"> • Inexpensive • Easy to install • Work well for a variety of fluid densities 	<ul style="list-style-type: none"> • Float is calibrated to fluid it measures, so it must be recalibrated when density changes • Only useful for point measurements
Differential pressure devices relate liquid level to the size of pressure difference between bottom of tank and vapor space at the top	<ul style="list-style-type: none"> • Can monitor continuously • Easy installation for liquid applications 	<ul style="list-style-type: none"> • Requires constant density • Fluid needs to be sealed in pressurized vessels • Calibration can be difficult
Electromechanical devices have a motor-operated paddle or vibrating fork that is submerged into a vessel and stops rotating or vibrating when covered with material	<ul style="list-style-type: none"> • Cost-effective • Low maintenance requirements • Well-suited to solids, chips and pellets • Independent of material dielectric properties 	<ul style="list-style-type: none"> • Cannot provide continuous measurement
Capacitance probes sense differences in capacitance when air or material is present in a tank or vessel	<ul style="list-style-type: none"> • Produces highly accurate and repeatable results • Easy to install (requires only one opening) • No moving parts to wear out 	<ul style="list-style-type: none"> • Chemical compatibility between device and material is important • Changes to chemical composition and temperature can affect dielectric properties and alter results • Calibration can be time-consuming
Ultrasonic devices use a piezoelectric crystal to create sound waves, which are directed at the material. Sound waves are reflected back to the receiving device. The distance can be calculated from the echo, and level determined	<ul style="list-style-type: none"> • Can provide continuous monitoring of level • Few compatibility problems, since no contact with material is made • Low maintenance requirements • Not affected by changing dielectric properties 	<ul style="list-style-type: none"> • Dense vapor, dust or foam can affect measurements • Not for use in high (>300°F) temperatures and high (>8 bars) pressures
Radar devices transmit electromagnetic waves toward the material. Waves are reflected off the material and back to the source. Transit time is related to level of material	<ul style="list-style-type: none"> • Can provide continuous monitoring of level • Unaffected by environmental factors, including pressure, temperature, vapor, steam and dust • Non-contacting (so no material deposits) • Relatively easy, top-of-tank installation 	<ul style="list-style-type: none"> • Cannot be used in open-air applications, because of regulatory requirements

Ready When and Where You Need Us



When it comes to your facility's service needs, you want a partner who has experienced it all. You want a partner that knows what is wrong and can fix it fast. TEAM Industrial Services provides the resources that can respond promptly with a comprehensive solution in any situation. Whether you are dealing with an emergency pipe repair or scheduled inspections, you can count on us to service your equipment quickly, safely, accurately and at the high level of quality people have come to expect from TEAM. With comprehensive service offerings and more than 100 U.S. and international locations, we'll be there when and where you need us.

Come visit Team out at NACE Corrosion 2014 Booth #2939.

TEAM experts are available 24 hours a day, 7 days a week, 365 days a year. Call TEAM today: **713-378-8600** or contact@teaminc.com.

TEAM Services

Bolting/Torquing	Manufacturing/ Engineering
Concrete Repair	Mechanical Integrity
Emissions Control	NDE/NDT Inspection
Exchanger Services	Specialty Welding
Field Machining	Turnkey Tank Program
Fitness for Service	Valve Insertion
Heat Treating	Valve Repair
Hot Tap/Line Stop	
Isolation Test Plugs	
Leak Repair	

TEAM® Industrial Services

www.teamindustrialservices.com

Circle 43 on p. 68 or go to adlinks.che.com/50974-43

Technology Profile

Ethylene and propylene are the most important intermediates in the petrochemical industry. Globally, they are produced mainly by steam cracking of hydrocarbons, such as naphtha, propane and ethane. The methanol-to-olefins (MTO) process is an alternative approach to producing these light olefins from methanol feedstock, which can be derived from other raw materials, including natural gas, coal or biomass.

The process

Figure 1 illustrates an MTO process similar to one developed jointly by UOP LLC (Des Plaines, Ill.; www.uop.com) and Norsk Hydro A/S (Oslo, Norway; www.hydro.com). This process synthesizes olefins from methanol using a SAPO-34-type zeolite catalyst in a fluidized-bed reactor. The process can be divided into three main areas: reaction and regeneration; quench, compression and caustic wash; and product fractionation.

Reaction and regeneration. Methanol feed is vaporized, mixed with recovered methanol, superheated and sent to the fluidized-bed reactor. In the reactor, methanol is first converted to a dimethylether (DME) intermediate and then converted to olefins with a very high selectivity for ethylene and propylene.

During the reaction, coke accumulates on the catalyst, which is circulated to the fluidized-bed regenerator system. In the regenerator, the coke is removed by combustion with air to maintain the catalyst activity. After leaving the reactor, the reacted stream exchanges heat with the reaction feed, in order to recover the heat generated by the exothermic reaction.

Quench, compression and caustic wash.

The output from the reaction and regeneration is quenched, where most of water and unreacted methanol is removed.

The water-methanol stream is sent to the methanol-recovery column, where methanol is recovered and recycled to the reaction.

The vapor stream from the quench stage is compressed and sent to a caustic wash column for CO₂ removal. The gas stream, free of CO₂, is then dried and sent to the product fractionation.

Product fractionation.

The dried stream from caustic wash is sent to the de-ethanizer column, where ethylene is separated from C₃ and larger (C₃+) hydrocarbons as the overhead product. The ethylene-rich stream is compressed and fed to the acetylene reactor for selective acetylene hydrogenation to ethane. The acetylene reactor effluent is sent to the de-methanizer column, where an ethylene-ethane mixture is separated from a methane-rich stream. The ethylene-ethane mixture is then routed to the C₂ splitter to obtain polymer-grade ethylene product as the overhead and an ethane-rich stream at the bottom.

The C₃+ stream from the bottom of the de-ethanizer column is fed to the de-propanizer column, for C₄+ separation as the bottom product. The de-propanizer column distillate, mainly containing a propylene-propane mixture, is fed to the C₃ splitter column. In the C₃ splitter, polymer-grade propylene is obtained as the overhead product, while the bottom stream is propane-rich.

Economic performance

The total fixed investment of the process was estimated based on data from the second quarter of 2013 for units erected on the U.S. Gulf Coast and in China (Figure 2). The following assumptions were taken into consideration:

- The plant capacity is 600,000 ton/yr of light olefins (ethylene and propylene)

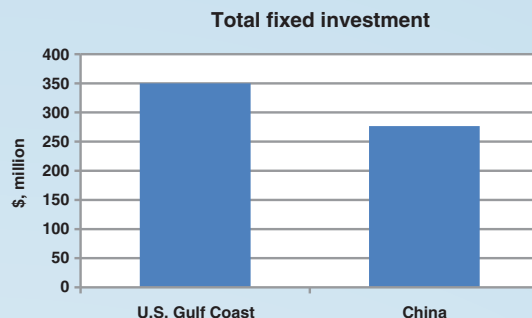

FIGURE 2. Total fixed investment to build an MTO plant in different regions

- The process equipment is represented in the simplified flowsheet
- The plant is constructed inside a chemical complex. The methanol feedstock is locally provided and propylene and ethylene products are consumed by nearby poly-olefins units. Therefore, no storage for product or raw material is required

The MTO process is an alternative approach to producing ethylene and propylene for chemical manufacturers that have access to cheap sources of methanol, which can be supplied from catalytic conversion of synthesis gas. China's low manufacturing costs, as well as low investment requirements, explains the recent plans to construct MTO plants in the country to monetize excess coal resources. In the U.S. on the other hand, methanol can be produced from low-cost shale gas. ■

Editor's Note: The content for this column is supplied by Intratec Solutions LLC (Houston; www.intratec.us) and edited by *Chemical Engineering*. The analyses and models presented herein are prepared on the basis of publicly available and non-confidential information. The information and analysis are the opinions of Intratec and do not represent the point of view of any third parties. More information about the methodology for preparing this type of analysis can be found, along with terms of use, at www.intratec.us/che.

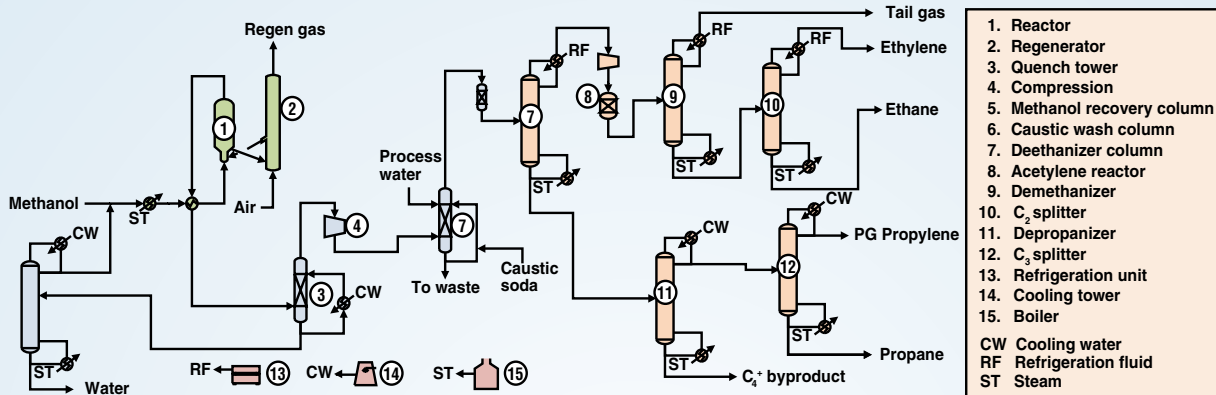

FIGURE 1. Methanol-to-olefins technology similar to UOP/Hydro MTO process

Implementing a Corrosion-Under-Insulation Program

CPI facilities need to put in place a systematic program for preventing and mitigating corrosion under insulation

Russ Davis
The Mistras Group, Inc.

Corrosion to the external surface of process piping and vessels that is hidden under the insulation is referred to as corrosion under insulation (CUI). Aging piping and equipment in chemical plants and petroleum refineries have made CUI detection and assessment requirements increasingly important. Because the need to detect and assess CUI is critical in chemical process industries (CPI) facilities, inspection and testing methodologies have been pushed to improve. However, many CPI facilities lack an insulation-repair program. The best approach to address the problem of CUI is to develop and adopt a comprehensive and facility-wide CUI program. This article describes the components of such a program and is designed to help facility managers and engineers identify strategies to implement it.

Industry estimates indicate that CUI costs the chemical and oil-and-gas industries in excess of \$100 million annually. This cost represents only the estimated damage to the equipment, and does not include the losses that may be associated with process downtime. Taking equipment and piping out of service when they are needed to make product will raise the level of losses. This estimate also does not include

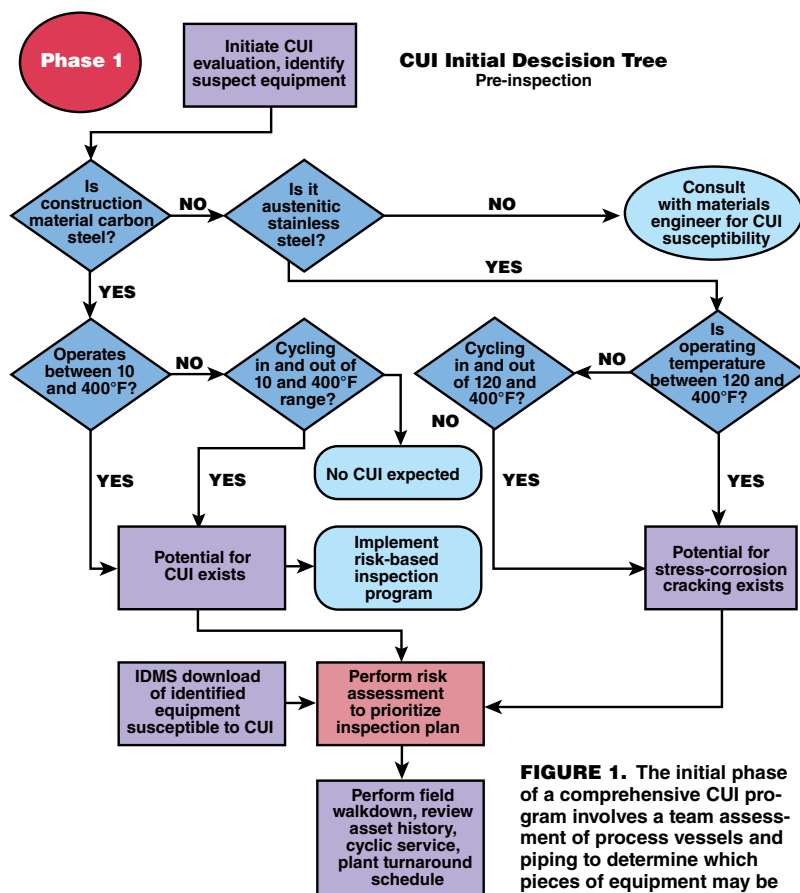

FIGURE 1. The initial phase of a comprehensive CUI program involves a team assessment of process vessels and piping to determine which pieces of equipment may be susceptible to CUI

the risk posed by CUI for potential exposure to hazardous chemicals, as well as the potential fire and explosion hazards, resulting from the loss of containment of highly hazardous chemicals. Sometimes, corrosion-preventive painting programs are cut when budgets are tight.

CUI primarily affects carbon-steel and low-alloy steel vessels and piping. Operating conditions noted for making equipment susceptible to CUI range from 10°F (−12°C) to 400°F (205°C). Austenitic stainless steels and duplex stainless

steels are also susceptible to CUI, especially in coastal geographic regions where the normal atmosphere contains chlorides and where the equipment operates between 140°F (60°C) and 400°F (205°C). Chloride-induced stress corrosion cracking (SCC) has been found in austenitic stainless steels due to the chloride content of the normal environment.

Program components

It is essential that a programmatic approach to reducing the risk of operations includes a focus on CUI

TABLE 1. NON-DESTRUCTIVE EXAMINATION (NDE) METHODS FOR DETERMINING THE PRESENCE OF CUI: ADVANTAGES AND DISADVANTAGES

Method	Advantages	Disadvantages
Visual inspection of pipes and equipment	<ul style="list-style-type: none"> • Qualitative inspection • Immediate validation of results 	<ul style="list-style-type: none"> • Requires stripping of all insulation • Extensive staging or scaffolding may be required • Slow • Expensive where hazardous materials are present • Potential to miss critical locations
Radiography film Conventional X-ray technology where radiation passes through material and creates image on film	<ul style="list-style-type: none"> • Qualitative and quantitative results possible • Thickness measurements are possible • Can identify conditions of both outer diameter and inner diameter 	<ul style="list-style-type: none"> • Longer exposure times • Accuracies are $\pm 10\%$ • Film processing is required, so results are delayed • Environmental issues with chemicals • Image adjustment is not possible • Archival restrictions
Radiography CR (computed radiography) X-ray images are digitized and displayed on computer	<ul style="list-style-type: none"> • Qualitative and quantitative results possible • Accurate measurements possible • Can identify conditions of both outer diameter and inner diameter • No insulation removal required • Software image enhancement possible • Electronic media for easy archiving 	<ul style="list-style-type: none"> • Covers limited area • Requires direct access to inspection area • Cost control is based on access and production rate • Radiation hazards • Imaging plate care required
Realtime (RT) radiography Low-power X-ray- or isotope-based digital fluoroscopy equipment that provides view of outer diameter of pipe	<ul style="list-style-type: none"> • Identifies outer surface conditions • Allows fast (immediate) results • No insulation removal required • No radiation hazards 	<ul style="list-style-type: none"> • Close-proximity piping runs and pipe geometry can restrict inspection • Production slower in close-spaced piping • Inspection unit is cumbersome in tight spaces
Guided wave inspection Uses low-frequency ultrasonic waves to detect general corrosion and wall loss	<ul style="list-style-type: none"> • Rapid inspection of long lengths of pipe are possible (1,500 to 3,500 ft/d) • 100% volumetric coverage • Limited insulation removal for inspection • Accurate location of pipe features and corrosion • Semi-qualitative analysis of wall loss • Temperature range to 550°F • Most cost-effective method for very long lengths of pipe 	<ul style="list-style-type: none"> • Qualitative screening • Requires secondary method for verification of anomalies • Geometry can restrict inspection
Pulsed eddy current (PEC) Electric current is introduced, then switched off to generate eddy currents, which are detected by receiver coils	<ul style="list-style-type: none"> • Fast • No insulation removal required • Easily deployed • High-temperature capability • Non-contact method • Qualitative data 	<ul style="list-style-type: none"> • Close-proximity piping can limit access • Inspection of piping less than 3 in. in diameter is not possible
Hydrotector Determines moisture content in insulation by measuring neutron scatter by hydrogen atoms in the water	<ul style="list-style-type: none"> • Initial screening for wet insulation before employing other CUI methods • Fast • No insulation removal required 	<ul style="list-style-type: none"> • Only useful for wet insulation; does not detect dry insulation that has been wet • Screening tool only • No data on actual pipe condition

detection and mitigation. In general, a comprehensive CUI program should consist of at least the following aspects:

- Prevention of CUI
- Early detection
- Mitigation
- Mechanical-integrity preventative maintenance programs designed to continually address the hazards of CUI

The process for addressing CUI within the comprehensive facility-specific program should consist of at least these three phases:

- Determining what equipment is in the program
- Performing a field walkdown of

the vessels and piping identified in the first phase

- Performing effective and efficient inspection and testing of the equipment and piping

For each phase of the CUI program, this article includes a decision tree that is designed to assist engineers and managers to systematically approach CUI assessments, repairs and documentation. The decision trees can be found in Figures 1–4.

Phase I

The initial Phase 1 determination of what equipment is to be included in the CUI program generally consists of a team assessment of the

process vessels and piping to determine what is susceptible to CUI. The team should evaluate and consider the operating temperatures and material of construction of each of the pieces of equipment to make the determination. This information may come from plant engineering files and operational history, or it can be downloaded from the inspection data management system (IDMS).

After the team has determined what equipment will be included in the program, it is good practice to prioritize those equipment items by performing a risk assessment to determine where the higher-conse-

quence events would occur if there was a loss of containment. The team must always fully understand the operating process and include those vessels that are frequently idle, even if they operate in a temperature range not usually noted for susceptibility to CUI.

The team should be composed of at least one member who is familiar with the materials of construction of the vessels and piping being evaluated, as well as at least one member knowledgeable in the process temperatures at which the equipment operates, and a member knowledgeable about the CUI damage mechanism. In addition the team should include a member who is familiar with the inspection history of the vessels and piping within the program.

The analysis team should use a formalized approach to the determination. A logic decision tree can be very helpful (Figure 1).

The team's initial assessment should pay particular attention to the following equipment and piping susceptible to CUI:

- Areas exposed to mist over-spray from cooling water towers
- Areas subjected to process spills, ingress of moisture or acid vapors
- Dead-legs and attachments; that is, drains, vents and so on
- Pipe hangers and other supports
- Vibrating piping systems
- Steam-traced piping systems that may experience tracing leaks

Phase 2

Phase 2 consists of a field walkdown by qualified subject-matter experts (SMEs). These experts determine what non-destructive examination (NDE) methodology is best suited for discovering whether and how CUI may be affecting each vessel and piping system. The SMEs can also determine the most efficient and effective method for performing the inspection and tests. Table 1 shows a brief analysis of NDE methods that can be used to determine the presence of CUI.

During the Phase 2 field assessment, accessibility issues associated with each piece of equipment and

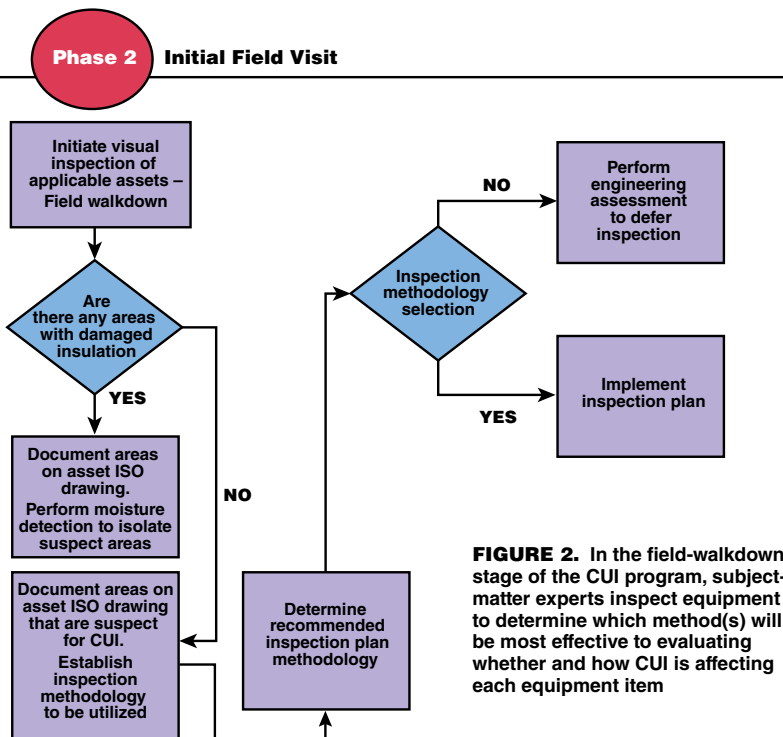

FIGURE 2. In the field-walkdown stage of the CUI program, subject-matter experts inspect equipment to determine which method(s) will be most effective to evaluating whether and how CUI is affecting each equipment item

Phase 3: Field Inspection

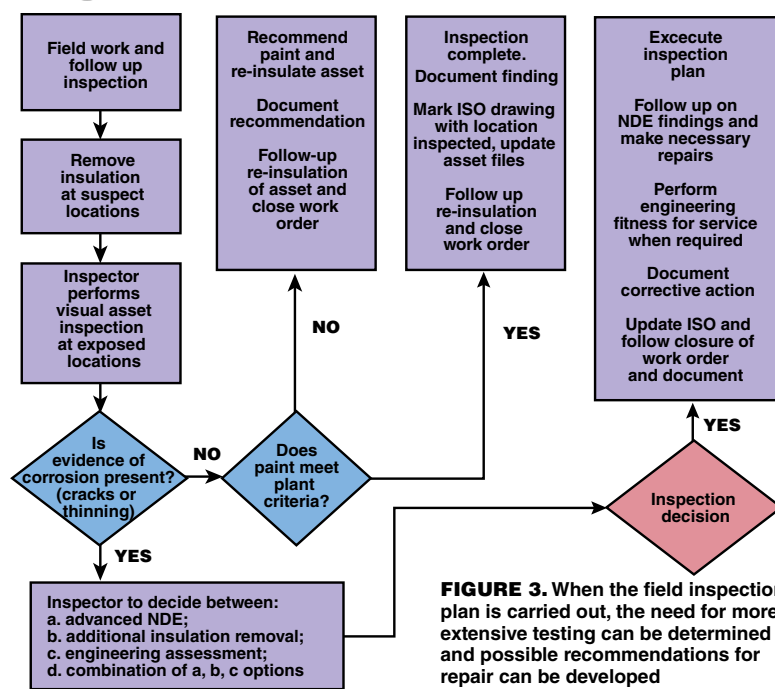
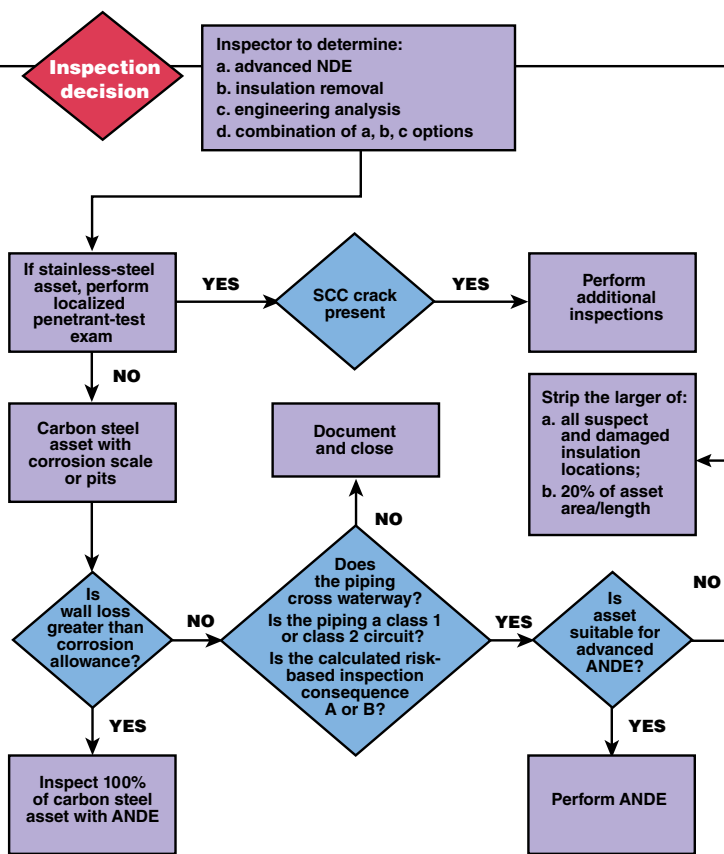

FIGURE 3. When the field inspection plan is carried out, the need for more extensive testing can be determined and possible recommendations for repair can be developed

piping can also be analyzed. Determining, for example, where scaffolding must be utilized or where rope access is needed can be of significant value. Rope access has made a tremendous contribution to the

inspection and testing field. Inspectors are able to perform any NDE method from ropes, thus reducing the need for scaffolding and greatly reducing the cost of inspections. There must be anchor points avail-



Note 1:

1. If there are additional findings, then follow-up inspection will be required in accordance with this process. If there are no additional findings, then spot repairs will be completed and inspection results documented in the asset inspection files.

FIGURE 4. If corrosion is observed at suspect CUI locations, more in-depth assessments, probably involving advanced non-destructive testing methods, are undertaken

able for the rope access team to use for anchoring their ropes. The field assessment can determine where rope access would be effective and which NDE method will yield the most significant data at the right cost level. Figure 2 is an example of the logic flow the field team can follow to determine the most effective inspection and test methodology. The field walkdown team should pay particular attention to:

- The bottom of horizontal lines in piping systems susceptible to CUI
- Any break in the vapor retarder on cold lines
- Damaged or missing insulation jacketing
- Location where inspection plugs have been removed
- Piping systems with deteriorated coatings or wrappings
- Termination of insulation at flanges and other piping components

Phase 3

Phase 3 of the program should consist of the most effective and efficient methods of testing and inspection for the detection of CUI. Inspection and testing findings can be evaluated, and additional inspection and testing needs can be quickly determined. Recommendations can then be developed to address those issues that were identified in the previous phase. Vessel and piping repair plans can be developed and next inspection dates set. Figure 3 is an example of a logic flow for Phase 3 that the testing and inspection team can use during the screening part of the implementation phase.

It is not economical or feasible to expect that the inspection and testing will cover 100% of the equipment and piping susceptible to CUI. Screening inspections and testing will be conducted to identify suspect areas. Once these areas are identified, the decision will be made on

the most effective and economical method for follow-up inspections. Figure 4 is a logic flow for determining whether or not follow-up inspections should be performed, as well as if advanced non-destructive evaluation (ANDE) methods should be used in lieu of insulation stripping. It is costly to remove and replace insulation, especially if it is not fully necessary. In many cases, the most economical method could be an ANDE method. The advantages and disadvantages of ANDE methods are also discussed in Table 1.

Summary remarks

CUI is a serious hazard affecting the safety and reliability of chemical plants, petroleum refineries, midstream terminals and just about all oil-and-gas operating facilities. To best address the problem, CUI must be addressed in a systematic or programmatic approach. The program must be fully defined and staffed with qualified personnel. Effective and economical inspection and testing methodologies should be utilized as part of the CUI detection program. By addressing CUI effectively, the risk of operations is reduced significantly and the equipment and plant reliability is increased. A safely and reliably operating facility is the product of a proactive CUI program. ■

Edited by Scott Jenkins

Author



Russ Davis is the National Asset Integrity Management Services (AIMS) manager in the services division of the Mistras Group Inc. (4000 Underwood Road, LaPorte, TX 77571; Phone: 281-478-1636; Email: Russ.Davis@mistrasgroup.com). Davis has spent over 26 years in mechanical-integrity program development and implementation. His experience includes pressure vessels, aboveground storage tanks, and piping inspection, testing and evaluation. Davis has an extensive background in process safety management, including hazard assessment and consequence evaluation. He has developed and directed mechanical integrity (MI) programs for a global chemical company. Davis has served as an MI consultant, as well as external consultant for the implementation of MI programs. He has a solid working knowledge of NDE, damage mechanisms, and materials of construction for equipment in the petroleum refining, chemical and energy industries. He is also experienced in equipment failure analysis, lifecycle analysis and failure frequencies. Davis is an API-certified inspector, an ISA 84 Fundamentals Specialist and a certified safety professional.

Mass Transfer in Fermentation Scaleup

As fermenters are scaled up to huge sizes, mass transfer is a key consideration

Jim Gregory and Bob Green
Fluor

Nicolle Courtemanche
and Richard Kehn
SPX Flow Technology, Lightnin

How big can a fermenter get? And what would the biggest fermenter look like? The answers to these questions depend upon how the requirements of heat transfer, mass transfer (gas-to-liquid), and momentum transfer (mixing) are met. In an earlier article (Heat Transfer for Huge-Scale Fermentation, *Chem. Eng.*, November 2013, pp. 44–46) the authors described how heat-transfer requirements can cause jackets to become ineffective at large scale, which drives the need for external heat exchangers. This article examines the issues that arise with mass and momentum transfer at huge scales. The concerns associated with mass transfer at huge scales also influence the type and size of pilot- and demonstration-plant facilities that are used in scaleup.

Many useful chemicals can be produced by microbes that require oxygen to grow. An aerobic fermenter is used to grow these microbes and create the right conditions for them to produce these chemicals. This type of fermenter is essentially a mass transfer device that promotes the transfer of oxygen from gas bub-

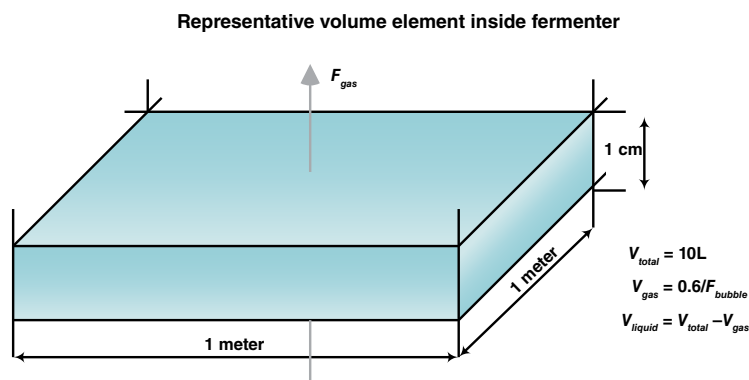

FIGURE 1. A representative volume element of the fermenter is depicted in this sketch, where V is volume and F is the gas flowrate

TABLE 1. NUMBER OF FERMENTERS REQUIRED FOR A GIVEN DIAMETER

Fermenter diameter, ft	10	15	20	25	30	35	40	45	50	55	60
Volume, 1,000 gal w/v	28	63	113	176	254	345	451	571	705	853	1,015
Number of fermenters required	284	126	71	45	32	23	18	14	11	9	8
Harvest interval, h	0.4	1.0	1.8	2.7	3.9	5.4	7.0	8.9	11.0	13.3	15.8
Required seed fermenters											
Number of seed trains	110	49	28	18	13	9	7	6	5	4	4
S-1 Seed, 1,000 gal w/v	2.8	6.3	11.3	17.6	25.4	34.5	45.1	57.1	70.5	85.3	101.5
S-2 Seed, 1,000 gal w/v	0.3	0.6	1.1	1.8	2.5	3.5	4.5	5.7	7.0	8.5	10.2
S-3 Seed, gal w/v	28	63	113	176	254	345	451	571	705	853	1,015
S-4 Seed, gal w/v			11.3	17.6	25.4	34.5	45.1	57.1	70.5	85.3	101.5
S-5 Seed, gal w/v										8.5	10.2

bles into the liquid medium where the microbes live. Often the rate of oxygen transfer is the limiting factor in the whole manufacturing process. That is why maximum oxygen-transfer rate is a key to a successful fermenter design.

A hypothetical process

Outlining a hypothetical fermentation process, such as the following one, gives a sense of the need for huge fermenters:

Objective: Make 100,000 ton/yr of product

Assumptions:

- The final fermenter broth is 5% w/w product after 100 hours of incubation time
- Use 10% inoculum
- Seed stages incubate for 36 h with a 12-h turnaround time
- The fermenter specific gravity is equal to 1.02
- The maximum fill of the fermenter is 80%
- The maximum fermenter straight-side height is 60 ft
- The oxygen uptake rate is 100 mmole/L/h



FIGURE 2. This configuration of a combined radial- and axial-impeller system is typical to provide mixing in an aerobic fermenter

- The fermenter turnaround time is 25 h (to harvest, clean, sanitize, fill and inoculate)
- Planned down time is 30 days for an annual overhaul, plus 15 days of contingency
- The downstream yield is 95%

Calculations:

1. Fermenter production requirement = $(100,000 \text{ ton/yr})/(95\% \text{ yield}) = 105,000 \text{ ton/yr}$
2. Fermenter broth required = $[(105,000 \text{ ton/yr})(2,000 \text{ lb/ton})]/(0.05 \text{ ton product/ton broth}) = 4,200,000,000 \text{ lb broth/yr}$
3. Fermenter volumetric production = $(4,200 \text{ million lb broth/yr})/[(8.34 \text{ lb/gal})(1.02)] = 494,000,000 \text{ gal/yr} = 1,540,000 \text{ gal/d} = 64,300 \text{ gal/h} = 1,070 \text{ gal/min}$
4. Total fermenter capacity requirement (working volume) = $(64,300 \text{ gal/h})(125 \text{ h/fermenter cycle}) = 8,000,000 \text{ gal}$

How many fermenters would be needed to offer 8,000,000 gallons of net tank capacity? Table 1 offers some options for the number of fermenters required versus fermenter size, using the assumption that the fermenter height is limited to 60 ft.

Ten-foot-diameter fermenters are known to be capable of production rates of 100 mmole/L/h and are economical, but that size would require 284 fermenters and 110 “seed trains” (see next section). It is hard to believe this would be an economical plant design. If the fermenters could be 60 ft in diameter, then there would be eight of them and four seed trains.

Seed trains: A fermentation process typically involves inoculating a batch of sterile growth media with a “seed,” which consists of viable microbes of the desired type. A 1-mL vial could inoculate a 100-mL flask, which would grow enough to inoculate a 10-L vessel, which would grow to inoculate a 1,000-L tank and so on. In this way, a production fermenter requires a series of smaller fermenters to produce a

sufficient volume of inoculum. Since the seed fermenters operate in series, they are often referred to as a “seed train.”

Oxygen transfer

A fermenter’s oxygen transfer rate (OTR) is a function of the oxygen transfer driving force, the surface area across which the oxygen flows, and the resistance to oxygen transfer:

$$\text{OTR} = k_L \times a(C_{\text{bubble}} - C_{\text{liquid}}) \quad (1)$$

where OTR is the oxygen transfer rate in mmol/h; k_L = conductance (reciprocal of resistance) to oxygen transfer; a is the surface area of oxygen transfer in square feet; and C is the oxygen concentration.

This means that the oxygen transfer rate can be increased by increasing k_L , a , or the change in C .

The effect of tank height

One of the primary constraints associated with mass transfer in fermenters is that bubbles rise only so fast. No matter how much air is introduced at the bottom, the bubbles will rise at a rate dependent on the bubble size and the liquid density and viscosity, not on the rate of air being blown into the tank. The effect is that increasing airflow increases the availability of air in the fermenter. The inventory of air at any time, the void fraction, displaces product.

For a very large fermenter with water-like fermentation broth, the

average-sized air bubbles could rise at a rate of about 0.6 meters per second (m/s). That means that a superficial air velocity of 0.3 m/s results in a fermenter that is 50% liquid and 50% air bubbles. That is not a very productive fermenter.

As the gas bubbles rise, oxygen is transferred from the air to the liquid. The average oxygen concentration in the gas phase goes down with increasing height.

Consider a representative volume element of the fermenter that is one meter per side and one centimeter tall as in Figure 1. Assume that the oxygen uptake rate is 100 mmol O₂/L/h throughout the fermenter; the superficial gas rate is 0.1 m/s (0.1 m³/s per square meter of horizontal surface); and the bubble rise velocity for this system is 0.6 m/s. The maximum fermenter height can be calculated as follows:

1. Oxygen supplied to the bottom square meter column element = $[(0.1 \text{ m}^3/\text{s})(1,000 \text{ L/m}^3)(0.209 \text{ mol O}_2/\text{mol air})]/(24.5 \text{ L/mol air at } 25^\circ\text{C}) = 0.83 \text{ mol O}_2/\text{s}$
2. The void fraction in a representative volume element = $(0.1 \text{ m/s})/(0.6 \text{ m/s}) = 0.17$
3. The liquid volume in a representative volume element = $(1\text{m})(1\text{m})(0.01\text{m})(1,000 \text{ L/m}^3)(1 - 0.17) = 8.3 \text{ L}$
4. Oxygen consumed by each volume element = $[(100 \text{ mmol O}_2/\text{L/h})(8.3 \text{ L})]/[(1,000 \text{ mmol/mol})(3,600 \text{ s/h})] = 0.00023 \text{ mol O}_2/\text{s}$ per volume element
5. The number of volume elements in column of liquid = $0.83 \text{ mol/s}/(0.00023 \text{ mol O}_2/\text{s}/\text{volume element}) = 3,600 \text{ elements} = 3,600 \text{ cm} = 36 \text{ m} = 118 \text{ ft}$

It makes no sense to scale this process up to a height of above 36 m because the oxygen is completely depleted from the sparge air at that height. Actually, the oxygen concentration would never drop to zero, because the oxygen transfer driving force falls along with the oxygen concentration, so the top of the fermenter suffers from diminishing returns.

In the above calculation it has been assumed that there is neg-

ligible axial mixing of the liquid. This type of mixing in an actual fermenter (Figure 2) would serve to move dissolved oxygen that is near the bottom to upper levels where it is needed, and to move oxygen-depleted liquid that is near the top to flow downward. This movement increases the oxygen-transfer driving force near the bottom of the fermenter. However, as shown in Figure 3B, the improvement in the oxygen transfer rate near the bottom of the fermenter causes the oxygen in the gas to run out sooner.

The fermenter should not be designed as tall as 36 m, because of the very poor oxygen transfer in the upper part of the fermenter at such heights. Thus, huge fermenters need to grow fat, not tall.

High gas flowrates to the fermenter increase the number of bubbles, which increases the bubble surface area and thereby increases $k_L \times a$. In addition, with more airflow the oxygen concentration depletes more slowly, thereby increasing the overall oxygen-transfer driving force. However, since the bubbles rise only so fast, the increasing airflow will decrease the liquid volume in the tank. An increase in gas flowrate will also increase the agitator size. The more air there is, the more the impellers will have to disperse, and the higher the mixer motor power will be. This presents an interesting optimization problem. What is the optimum air flowrate?

Demonstration scale

Scaleup is about business risk. In order to evaluate the risk involved, it is important to determine what elements of the design involve performance uncertainty. An intermediate-scale demonstration plant might be required to prove that scaleup considerations are well understood. Thanks to the use of external heat exchangers, the heat transfer coefficients (U), the effective heat-transfer area (A), and the temperature driving forces (ΔT) are all known, so that heat (Q) can be calculated:

$$Q = (U)(A)(\Delta T_{\log \text{ mean}}) \quad (2)$$

The above analysis shows that,

GUIDELINES FOR PILOT PLANT TESTING

1. The minimum volume should be 250 gal (950 L) for scalable mass-transfer testing. A 20-gal tank can be used to evaluate blending and impeller placement
2. Liquid-level-to-tank-height ratio, and tank geometry should be similar to full scale
3. Baffles and heating coils on pilot scale should be similar to full-scale tank
4. Test the fluid with the organism, if possible. If not, use water, knowing the oxygen transfer rate results will be different
5. The gas and sparging system should be similar (the same would be better) as the one to be used on full scale
6. Make sure the sparge location is under the main gas-dispersing impeller
7. Use a rotameter with capabilities to fluctuate the gas flowrate over a range (use at least four different flowrates)
8. One flowrate should be the same vessel volumes per minute as the full scale — achieving the same superficial gas velocity will be difficult
9. Different styles and diameter of impellers should be tested. Include the ability to adjust location of the impellers
10. Variable-speed drive should be used to alter speed to test four different power levels
11. Use a tachometer to measure the operating speed of the shaft and impeller
12. Use a torque sensor to record mixer horsepower while the test is running
13. Dissolved oxygen probe locations should be at the top and the bottom of the tank. Keep them away from baffles and any other dead spots
14. Take note of how important the location of the lower impeller is in relation to the sparger
15. Make sure the tank will be tall enough to account for the gas hold-up. The hold-up will increase the liquid level, sometimes significantly, if the mixer has produced a well-dispersed system
16. Acid/base indicator or conductivity probes can be used for qualitative blend-time evaluation □

for heat transfer, the design factors are already well understood and predictable, and thus present a low risk to the project. In the case of mass transfer, however, the mass transfer conductance used in Equation (1) is not well known for fermenters above about 100,000 gallons. Pilot testing is required.

Pilot-scale testing

Pilot work is critical for any new process. For fermentation applications, pilot work is required to understand how the organism will behave under specific process conditions. The information studied on the pilot scale for a fermenter must include the following: mass transfer, gas dispersion and blending. All three are of equal importance.

If the mass transfer requirements are not met, the organisms in the fermenter will die because there is not enough power available to force the liquid/gas boundary layer transfer to take place.

If the gas dispersion requirements are not met, the air is not properly distributed throughout the vessel and again, the organisms will die. If the tank is not well blended, the nutrients that are added to the vessel, the heat transfer and the pH will not be uniform. The organism will not survive in this environment.

All of these are undesirable results.

The information gleaned from the pilot work is used to successfully model the full-scale operation. Pilot plant work will determine what impeller style(s), diameter(s) and power levels are required for the agitator to successfully perform.

Proper experiment set-up and execution will make sure repeatable results are achieved on the full scale. The specific parameters that must be examined are: tank geometry, baffle and coil arrangement and gas-sparging system. The tank geometry ratios, and baffle and coil arrangements should be similar between full scale and pilot scale. Pilot testing should be done with the exact process fluid to be used on the full scale, or a fluid with very similar properties. The liquid-level-to-tank-diameter ratio should be constant in scaleup, as should the type of gas and sparge system. The lower impeller should be located at a specific distance above the sparger and that ratio should remain unchanged between scales.

Traditional laboratory-scale testing is performed at a minimum volume range between 20 to 250 gal. When considering pilot scale work, a tank with a minimum volume of 750 gal, or a 4-ft-dia. \times 8-ft tank should be considered.

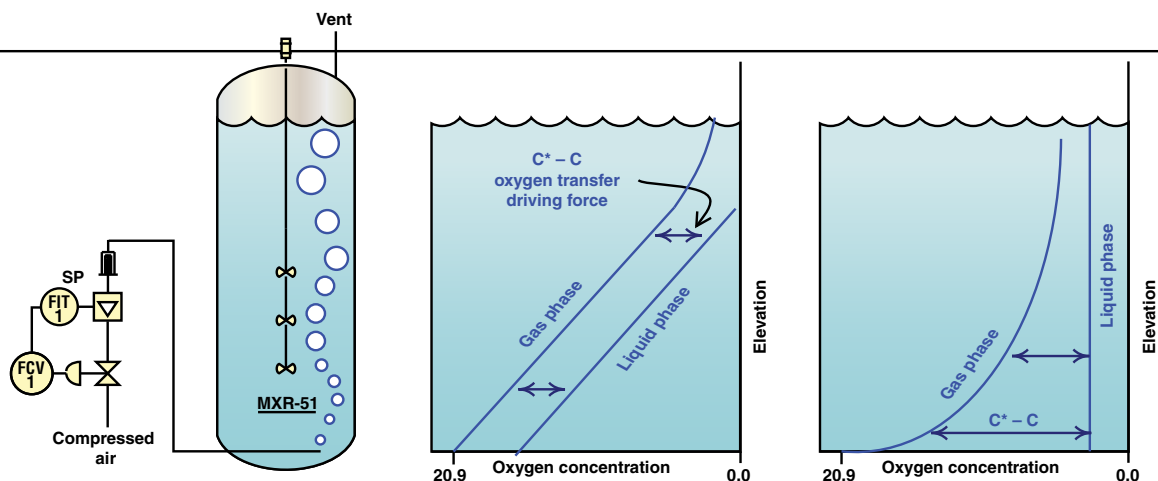

FIGURE 3. The oxygen transfer rates and the amount of dissolved oxygen in the liquid are strongly affected by mixing in a fermenter

A. When mass-transfer effects are greater than axial mixing effects, the oxygen transfer rate is uniform and the dissolved oxygen varies with fermenter height

B. When axial mixing is sufficient to make mass-transfer limiting, then the dissolved oxygen is uniform throughout the fermenter, and mass-transfer rates are higher at the bottom where oxygen is introduced

For the 1-million-gal scale, a larger test volume would be recommended. Here, the minimum would be 10- to 12-ft-dia. vessels. A torque sensor affixed to the shaft that records data while the test is running is a necessity. Reading power using an ampere or watt meter is not recommended, especially during pilot testing. A tachometer that can accurately measure the lower shaft speed is required.

A rotameter with capabilities of adjusting the gas flowrate over a specific range is also required. At a minimum, four different gas flowrates should be examined. One gas flowrate should be the same vessel volumes per minute (VVM) as the full-scale. (VVM is a unit of gas flowrate widely used in the fermentation industry.) It will be difficult to achieve the same superficial gas velocities at full and pilot scales.

While at the pilot scale, the style and diameter of impeller(s) should be reviewed for optimum performance. A few different styles and different diameters should be available to test. The impellers should be adjustable, so that their positions on the shaft can be changed while running different experiments.

Dissolved oxygen (DO) probes should be located at the top and bottom of the fermentation tank. The probes must be kept away from baffles or other potential low velocity or dead areas within the vessel. It is also necessary to study the gas hold-up volume on

the smaller scale to make sure the full-scale vessel will be tall enough to account for the increase in gas liquid volume.

Many of these points are summarized in the box on Guidelines For Pilot Plant Testing on p.46.

Final thoughts

When designing very large fermenters, care must be taken to avoid designs that are so tall that the upper portion of the fermenter is ineffective. Care must also be taken to provide adequate mixing and mass transfer

in very wide fermenter designs. Since unusual tank geometry is required for very large fermenters, scaleup ratios are smaller, so large demonstration-scale testing is beneficial.

Agitation is a big expense. Using a microbe that can tolerate low or zero dissolved oxygen is highly advantageous, because of the higher mass-transfer driving force that results. Also, a microbe that does not require oxygen to produce product has a clear economic advantage by reducing agitation costs. ■

Edited by Dorothy Lozowski

Authors



Jim Gregory is a process engineer at Fluor Corp. (100 Fluor Daniel Dr., Greenville, SC 29607-2762; Email: jim.gregory@fluor.com). He holds a B.A. in biophysics and a B.S.Ch.E. from the University of Connecticut, and an M.Sc. in biochemical engineering from Rutgers University. He has experience in the design and operation

of industrial microbiological processes ranging from human-cell-line monoclonal antibodies to diesel fuel.



C.R. Green (Bob) is director of design development at Fluor Corp. (same address as left; Email: bob.green@fluor.com). He holds a B.S. in mechanical engineering from North Carolina State and an M.E. in mechanical engineering from the University of South Carolina. He is a registered professional engineer in six states. Green has experience in the design and startup of microbiological processes, including human-cell-line monoclonal antibodies, amino acids, bacteria, biofuels and biochemicals.



Nicolle Courtemanche is a senior application engineer at SPX Flow Technology (Lightnin brand; 135 Mt. Read Blvd., Rochester, NY 14611; Email: nicolle.courtemanche@spx.com), a segment of SPX that designs, manufactures and installs engineered solutions used to process, blend, meter and transport fluids, in addition to air and gas filtration

and dehydration. Nicolle holds a B.S.Ch.E. from the University of New Hampshire. Her areas of mixing expertise include, pulp and paper, biotech, pharmaceuticals and other chemical process industries.



Richard Kehn is manager of Research and Development at SPX Flow Technology (Lightnin brand; same address as left; Email: richard.kehn@spx.com). Kehn holds a B.S.Ch.E. from Rensselaer Polytechnic Institute and is pursuing an M.E. degree in mechanical engineering with a concentration in computational fluid dynamics (CFD) from Rochester Institute of Technology. Kehn has been the author or co-author of ten technical papers regarding mixing, covering low-viscosity blending, solids suspension, copper solvent extraction, slurry-tank-agitator design and CFD. His areas of mixing expertise include mineral processing, water and wastewater treatment, pulp and paper, and experimental methods including scaleup and scale-down.

FDA Form 483: Minimizing FDA Inspection Citations

One of the paramount issues related to FDA regulated products is that of documentation and record keeping related to manufacturing

W. M. Huitt
W. M. Huitt Co.

As an owner or manager of a company whose product is regulated by the U.S. Food and Drug Administration (FDA), you will, at some point, be subjected to an FDA inspection. And once an inspection is underway in your facility, anything affecting the drug or food product directly or indirectly in an adverse manner is within the purview of the FDA inspectors.

If discrepancies are found during such an inspection, one or more Form 483 Inspectional Observation Forms will be submitted to company management addressing each discrepancy. These will come at the conclusion of the inspection process, and each discrepancy will be discussed and explained. Keeping in mind that the majority of discrepancies will typically be subjective in nature, they can be wide-ranging in their impact and implication — from a housekeeping issue to product adulteration.

Form 483 is used by the FDA as a first step in correcting a product-related deficiency within a facility. Deficiencies can be related to computer programming, product-contact material of construction, procedural issues, material handling, documentation, and on and on. Anything, as mentioned earlier,

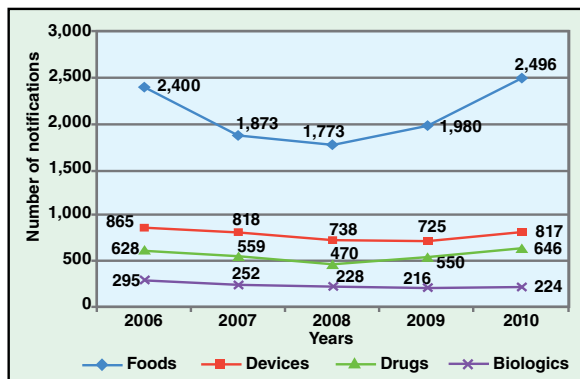

FIGURE 1. Of the four categories shown here, food processing has by far received the most Form 483 notifications throughout the five-year period plotted here (see also Tables 1 and 2)

that could affect the consistent and acceptable quality of the product is fair game.

Rather than cover the broad and varied manufacturing categories and subject matter encompassed by the use of Form 483, this discussion focuses more pointedly at those facilities that fall within the characterization of being included as a part of the chemical process industries (CPI).

The notification

As a first-step notification to facility management, Form 483 is the FDA's way of identifying and forewarning a company that certain aspects of its manufacturing process are not compliant with FDA regulations. Upon receipt of a Form 483 notification, the company will have fifteen working days in which to respond. This is not a requirement, but is simply an expectation.

Should a company not respond within that fifteen-day window, or should the response be considered insufficient or inadequate to correct the deficiency, the second shoe would fall in the form of a warning letter being issued.

The warning letter would first state the issue or issues reiterating the Form 483 infraction(s), fol-

lowed by a statement such as: "We have reviewed your firm's response of December 12, 2012, and note that it lacks sufficient corrective actions." The letter would then go on to elaborate, in significant detail, on why the response was inadequate and what was required to rectify the issue.

In many cases, the warning letter will include a cease-and-desist order, should its directive go unresolved or ignored, similar to what follows:

"Until all corrections have been completed and FDA has confirmed corrections of the violations and your firm's compliance with cGMP, FDA may withhold approval of any new applications or supplements listing your firm as a drug product manufacturer. In addition, failure to correct these violations may result in FDA refusing admission of articles manufactured at ABC Drug Co., located at 1234 Street, City, Country, into the United States."

Note: The above company name and address is fictitious and is not intended to apply to any company in particular.

The letter will finish by giving the respondent "fifteen working days" to respond with a clear and concise description as to what steps have been taken, or are to be under-

TABLE 1. OBSERVATIONS FROM FDA INSPECTS — NUMBER OF FORM 483s ISSUED BY YEAR					
483 Totals	Year				
	2010	2009	2008	2007	2006
Sum product area 483s from system ¹	5,306	4,612	4,307	4,630	5,383
Actual total of 483s in system ²	4,804	4,122	3,805	4,079	4,747
Total 483s for fiscal year ³	6,695	5,449	4,764	4,826	5,507
Total number of inspections/year	17,635	15,170	14,318	14,594	16,525

NOTES:

1. This table does not represent the complete set of Form 483s issued during the fiscal year as some 483s were manually prepared and not available in this format. The sum of Form 483s for all product areas will be greater than the actual total Form 483s issued during the fiscal year since a Form 483 may include citations related to multiple product areas, and counted more than once, under each relevant product center.
2. This is the actual total number of Form 483s issued from this system, and that are represented in this Table.
3. This is the count of the total number of Form 483s issued in and out of the system during a one-year period.

TABLE 2. FORM 483s ISSUED 10/1/2009 THROUGH 9/30/2010	
Category	Quantity issued
Foods	2,496
Devices	817
Drugs	646
Incidental text	303
Bioresearch monitoring	282
Veterinary medicine	232
Biologics	224
Parts 1240 & 1250	169
Human tissue for transplantation	111
Radiological health	16
Special requirements	10
Total	5,306
Total number of inspections same period	17,635
% Inspection having 483s	30%

taken to correct the listed deficiencies. Should those fifteen working days be exceeded with no effort at a response from the notified company, then any penalizing action described in the warning letter will go into effect.

Form 483 statistics

Referring to Table 1, in the five-year period from 2006 through 2010, there were a total of 78,242 FDA inspections encompassing eleven manufacturing categories. These inspections resulted in 27,241 Form 483s being recorded. Figure 1 represents a portion of those statistics, with four of the higher-ranking manufacturing categories providing a comparison between the four being represented. As readily seen, the food processing category far and away seems prone to attract the most FDA citations.

FDA inspection and enforcement falls under the responsibility of the FDA's Office of Regulatory Affairs (ORA). While the majority of Form 483s are generated through the electronic TurboEIR (Turbo Establishment Inspection Report) form reporting system, which is reflected in the data used for Table 1 and Figure 1, there are some instances in which these forms are filled out manually and are therefore not represented in these statistics. TurboEIR-generated 483s are categorized in the following manner:

- Biologics
- Drugs
- Devices
- Human tissue for transplantation
- Radiological health
- Parts 1240 & 1250
- Foods (includes dietary supplements)
- Veterinary medicine

- Bioresearch monitoring
- Incidental text
- Special requirements

Table 2 reflects, by category, the number of Form 483s issued from the TurboEIR system in descending quantity by category from October 1, 2009 through September 30, 2010.

Interpreting FDA regulations

The FDA inspectors, working through the ORA, are guided by three resources: The regulations set forth under Title 21 of the Code of Federal Regulations (CFR); its law enforcement counterpart Title 21 Chapter IX of the U.S. Code (USC); and their FDA training guidelines.

Training for FDA inspectors plays a big role in how they perceive, not only the rule of law under the USC, which by necessity is writ black and white, but to also understand the nuances and implications of the unwritten variants within the many complex guidelines and laws the manufacturer is obliged to follow under CFR Title 21.

One of the difficulties lies in the fact that many regulations governing the manufacture of food, drugs and cosmetics are, in many cases, intentionally vague. This is due in large measure to two basic facts:

1. Much of manufacturing is proprietary and specialized. It would be impossible to write detailed requirements that would apply to all manufacturing without constraining or interfering with development and inhibiting new concepts.
2. The criteria that the inspector must base their field analysis on is relative by nature and is subject to a subset of nuances that would be impossible to capture in

words, making broad statements in the CFR a necessity.

This is why, in Title 21 Chapter I Subchapter C Part 211 Subpart D, you will find such vague requirements as in Section 211.63, which states the following:

"211.63 Equipment design, size, and location. *Equipment used in the manufacture, processing, packing, or holding of a drug product shall be of appropriate design, adequate size, and suitably located to facilitate operations for its intended use and for its cleaning and maintenance.*"

The FDA cannot regulate the design of equipment, the size of equipment, or its location within a facility or its approximation to other equipment.

Another example of a vague requirement is in Section 211.67 where it states, in part:

"211.67 Equipment cleaning and maintenance. *Equipment and utensils shall be cleaned, maintained, and, as appropriate for the nature of the drug, sanitized and/or sterilized at appropriate intervals to prevent malfunctions or contamination that would alter the safety, identity, strength, quality, or purity of the drug product beyond the official or other established requirements.*"

In stating such a vague requirement, the FDA is leaving the design and procedural elements to industry. Without knowing a particular process, the FDA cannot possibly know the specific needs of its cleaning requirements. Instead, what is available for the engineer

or manufacturer are two sources to help meet FDA compliance. But before touching on these two very important sources, let us take a look at what is currently happening in this industry.

In referring back to Table 2 you can readily see that with 2,496 Form 483s issued in 2009, the “foods” category has, by far, the greatest number written against it; three times that of the second runner-up, devices with 817 infractions. Of that 2,496, an outstanding 61% were related to sanitary issues.

These sanitary issues include such incidents as rodent and insect infestations, improper or infrequent cleaning of equipment, and other sanitary issues having to do with waste, product storage, facility design and so on. This is an example of subjective calls made by the inspector regarding conditions that cannot be defined in simple black-and-white terms.

Such conditions are assessed based in large part upon what is contained in the broad set of parameters described in very general terms in Title 21 Chapter I Subchapter B Part 110 Subpart A Section 110.5 in which it states, in part:

“110.5 Current good manufacturing practice. *The criteria and definitions in this part shall apply in determining whether a food is adulterated (1) within the meaning of section 402(a)(3) of the act in that the food has been manufactured under such conditions that it is unfit for food; or (2) within the meaning of section 402(a)(4) of the act in that the food has been prepared, packed, or held under insanitary conditions whereby it may have become contaminated with filth, or whereby it may have been rendered injurious to health...*”

What occurs in many cases, whether it is food or drug products, is that the manufacturer or engineer interprets the finer points of an industry law or regulation in one way while the inspector interprets it in another. The following are cases-in-point:

- An issue cited 51 times during the fiscal year 10/1/2009 to 9/30/2010

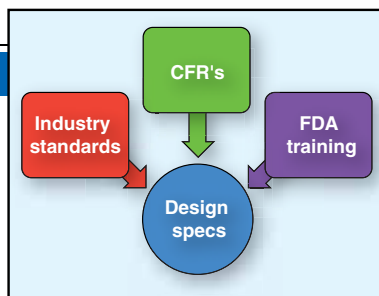

concerned equipment used in the manufacture, processing, packing or holding of drug products that was not of appropriate design, of adequate size, or suitably located to facilitate operations for its intended use, cleaning, or maintenance

- In that same time period, there were 61 cited incidents in which equipment and utensils were not cleaned, maintained and sanitized in an appropriate manner or at appropriate intervals to prevent malfunctions and contamination that could alter the safety, identity, strength, quality or purity of the drug product
- In addition to the two different types of incidents above, there were many other incidents that are too numerous to mention here, but one other does stand out — significantly. Over the same time period mentioned above there were in excess of 1,000 cited incidents concerning documentation including the following:
 - Written procedures were non-existent
 - Written procedures were not followed
 - No written record of investigations exists
 - No cleaning and maintenance records exist
 - No periodic review of procedures were conducted
 - No written sanitation procedures exist
 - And other incidents related to documentation

Documentation

One of the paramount issues related to FDA-regulated products, whether food or drug products, is that of documentation and record keeping related to manufacturing. These industries are repeatedly cited on this same issue. It includes documentation required to cover traceability of the product-contact material used in constructing process systems, and properly written

FIGURE 2. Proper design specifications will combine input from the three sources shown here

process descriptions, cleaning procedures, weld logs and material certification documents and more.

If metallic material, such as tubing or equipment will be in contact with the product, it will require traceability in the form of a heat number that can be traced back to the mill of origin. The heat number is the tracking number found on the Mill or Material Test Report (MTR). If it is non-metallic, it will require a Certificate of Compliance (C of C) for batch traceability back to its source of formulation.

This is all done with the intent to hold originating and modifying parties of a raw or finished product accountable in case the product is determined to be the source cause for adulterating a food, drug, or cosmetic product during production or post-production handling.

The material used to build the systems that manufacture food, drugs and cosmetics have been carefully selected and enhanced over the years to prevent contamination of a product through the inadvertent introduction of undesirable particulate matter into the product stream. This can occur through the leaching of non-metallic material or the use of poorly passivated stainless steel that could introduce iron oxides into the product stream.

Procedures should be written and followed, not only for the process itself, but for clean-in-place (CIP) and steam/sanitize-in-place (SIP) procedures as well. All maintenance and quality control procedures should be written and followed, with signed and dated log reports verifying the frequency and intervals in which these activities were performed.

Well written procedures, records, and documentation are not only proof to the FDA inspectors that well-thought-out operational programs were put in place, but it shows due diligence on behalf of the company, indicating that management takes seriously the safe and controlled manufacture of food, drugs and cosmetics.

The ease of access to appropriate documentation, its thoroughness, and organization will pay dividends, not

only for the FDA inspection process, but also for the company's bottom line, with regard to well controlled manufacturing and processing.

Regulatory blind spots

Getting back to the two sources for resolving the issue of filling in the blanks left by the vague regulatory requirements in Title 21 Chapter I Subchapter B Parts 110 & 111 (for food) and Subchapter C Parts 210 & 211 (for drugs). The following is an appropriate and rather easy way of helping to resolve this issue.

As mentioned earlier, with regard to FDA inspectors being trained to understand the nuances and implications of the unwritten variants in the FDA regulations, the best way to see what they see and to understand their expectations is by studying their training documents.

There are a set of "Inspection Guides" and "Inspection Technical

Guides" used in the FDA inspectors' training that are available at no cost and can be found at www.fda.gov/iceci/inspections. At this site you will also find access to other guides used by FDA inspectors, such as the following:

- Field Management Directives
- IOM: Investigations Operations Manual
- Guide to International Inspections and Travel
- Medical Device GMP Reference Information
- QS Regulation/Design Controls

There are also reams of guidance documents that can be found for drug-related regulations at (www.fda.gov/drugs/guidancecompliance-regulatoryinformation/guidances/default.htm) and for food-related regulations at (www.fda.gov/food/guidancecompliance-regulatoryinformation/default.htm). Much of the information found at these sites

is simply taken from what is written in the related CFR documents. It is provided in a somewhat easier-to-read format, however.

Reading the training and guidance literature and learning what the inspectors are trained to look for in specific cases will put your engineering, operations, and manufacturing personnel on the same page with what the inspector's expectations will be when they step foot inside your facility.

To go further in finding guidance for complying with regulatory requirements, as it relates to the CPI and the FDA, specific organizations such as 3-A Sanitary Standards, Inc. (3-A SSI; www.3-a.org), ISPE (International Society of Pharmaceutical Engineers; www.ispe.org), and ASME-BPE (American Society of Mechanical Engineers; www.asme.org — Bioprocessing Equipment) standards, provide a great



Ensure your piping integrity

In today's operating environment, it's more important than ever that the piping within your Mechanical Integrity Program complies with standards such as API-570 and API-574.

Quest Integrity offers a comprehensive solution for piping circuits using our proprietary, ultrasonic-based intelligent pigging technology combined with LifeQuest™ Fitness-for-Service software.

Ensure your piping integrity by identifying degradation before loss of containment occurs.

www.QuestIntegrity.com/CE
+1 253 893 7070

- 100% inspection of internal and external pipe surfaces
- Inspection results tailored to comply with API-570 and API-574
- LifeQuest Fitness-for-Service results tailored to comply with API-579



QUEST
INTEGRITY GROUP
Process • Pipeline • Power
A TEAM Industrial Services Company



Bursting Discs and Breather Valves

MADE IN GERMANY

www.rembe.com

Quickest Response and Lead Times

*** SAFETY is for life. ***

REMBE® GMBH • SAFETY + CONTROL
Gallbergweg 21 • 59929 Brilon / Germany
T + 49 (0) 29 61 - 74 05 0 • F + 49 (0) 29 61 - 5 07 14
sales@rembe.de

All rights reserved. © REMBE - BDBV2-4C-E

Circle 35 on p. 68 or go to adlinks.che.com/50974-35

Circle 36 on p. 68 or go to adlinks.che.com/50974-36

deal of specific insight, guidance, and answers that help fill the void not expressed or defined in the regulations themselves.

Looking to such resources, such as the FDA training literature and qualified industry standards mentioned above, will help any engineer or manufacturer through the maze of regulatory compliance and help them to build a better facility in the process.

Industry standards

In referring back to the previously mentioned requirements stated in Title 21 Chapter I Subchapter C Part 211 Subpart D Section 211.63, such vague regulatory requirements are looked at, assessed, studied, defined and vetted by the membership of accredited American National Standards Developers; the final results of which are published for industry use. These

assessments and studies are done by industry experts that invest themselves in the committees that make up the various industry-related standards organizations.

In this particular case, regarding Section 211.63, you can turn to the ASME-BPE Standard Part SD to find specific detailed information that will assist the engineer in meeting the essential requirements of Section 211.63 where it states, "... appropriate design, adequate size, and suitably located to facilitate operations for its intended use and for its cleaning and maintenance."

ASME-BPE Part SD explains, in graphic detail, what designs are acceptable with regard to vessels, pump seals, nozzle attachments and so on.

Or, in the case of the earlier mentioned Title 21 Chapter I Subchapter C Part 211 Subpart D Section 211.67 "Equipment Cleaning

and Maintenance," more specific details can be found in the ASME-BPE Standard on CIP and SIP system requirements.

ISPE offers regulatory-compliant guidelines on water- and steam-system design; system maintenance; final treatment technologies and basic system configurations related to the generation process of compendial purified water, highly purified water, non-compendial waters, and much more.

3-A SSI provides detailed guidance on the processing, handling and transport of food, dairy and beverage products, and has a relatively new standards committee for active pharmaceutical ingredients (API) equipment. This group is referred to as P3-A.

FDA inspection guidelines

With types of water being a common denominator between the vari-



Refresh Your Process

INTERNATIONAL
POWDER & BULK SOLIDS
CONFERENCE & EXHIBITION

May 6-8, 2014
Donald E. Stephens Convention Center
Rosemont, Illinois



2014 CHEMICAL ENGINEERING

CONNECT WITH OUR COMMUNITY:

UBM **POWDER & BULK SOLIDS** P E M A

Follow us on Twitter: @UBMPowderShows

Start the Process. Register today!
➔ PowderShow.com/Fresh

Circle 34 on p. 68 or go to adlinks.che.com/50974-34

ous FDA-regulated industries, we can use it as an example of how the FDA inspection guides can be utilized by the engineer. For this we will refer to the FDA's "Guide to Inspections of High-Purity Water Systems", which can be found at www.fda.gov/iceci/inspections/inspection-guides/ucm074905.htm

This guide includes the following chapters:

- I. System design
- II. System validation
- III. Microbial limits
- IV. Water for injection systems
- V. Stills
- VI. Heat exchangers
- VII. Holding tank
- VIII. Pumps
- IX. Piping
- X. Reverse osmosis
- XI. Purified water systems
- XII. Process water (numbered as XIII on website)
- XIII. Inspection strategy (numbered as XIV on website)

An example of what can be learned from an inspection guideline is represented in the following paragraph quoted from Paragraph II "System Validation." In it, the third paragraph states:

"In the review of a validation report, or in the validation of a high-purity water system, there are several aspects that should be considered. Documentation should include a description of the system along with a print. The drawing needs to show all equipment in the system from the water feed to points of use. It should also show all sampling points and their designations. If a system has no print, it is usually considered an objectionable condition. The thinking is if there is no print, then how can the system be validated? How can a quality control manager or microbiologist know where to sample? In those facilities observed without updated prints, serious problems were identified in these systems. The print should be compared to the actual system annually to insure its accuracy, to detect unreported changes and confirm reported changes to the system."

There are seven key take-aways from the "System Validation" para-

graph that includes the need for:

1. Preparation of a validation report
2. Written description of the piping system
3. A representative isometric drawing of the system
4. Drawings that show all equipment
5. Drawings that show identified sampling points
6. Point of use locations (with identifiers)
7. A quality management system that should include a process by which there is a requirement to walk down each system on a periodic basis at intervals that do not exceed a twelve month period in order to verify the system's as-installed condition

Final remarks

While there is so much more to be said with regard to the FDA's Form 483, and the Warning Letter for that matter, an essential point is that the FDA inspection process should not be treated like a thorn in the side. It should instead be treated as if you were working with a third-party inspector, an inspector with a little more force behind his or her decisions.

The key factor in all this is arguably the rules of engagement. As long as an owner or engineer understands the rules that the FDA inspector is playing by, an acceptable inspection result is certainly attainable. An acceptable inspection result is considered here to be one in which the inspection report would result in zero Form 483s or even one with a few minor Form 483s.

The basic disconnect lies in what the FDA inspector expects to see and how the owner or engineer plans to meet that expectation. In order to meet at that crossroads, the owner or engineer should preemptively develop a set of design and engineering specifications based on what can be gleaned from the three sources mentioned throughout this discussion. This would include, as represented in Figure 2: Proper CFRs, FDA inspector training guides, and industry standards.

Looking at the FDA inspector as

a third-party inspector, rather than as a law-enforcement official, will help a company understand him or her more as a beneficial asset and less as a hindrance. Unless a company is subversively attempting to circumvent regulations by skipping steps in the regulatory process, or is simply trying to keep cost down at the risk of food or drug adulteration, then an audit, however painful it might seem at the outset, should be looked upon as an incremental, beneficial, and integral part of the design, engineering, construction and commissioning process.

From a very fundamental perspective, we should all be designing and building facilities that manufacture product intended for human consumption and cosmetic application in a manner that will produce a product that is inherently safe in a consistent and verifiable manner with an overreaching consideration toward public health. The job of the FDA inspector is to verify that we are doing just that. ■

Edited by Gerald Ondrey

References

1. ASME-BPE Standard, www.asme.org/groups/1/technical-institutes-and-divisions/bioprocessing-equipment
2. International Society of Pharmaceutical Engineers (ISPE), www.ispe.org.
3. 3-A Sanitary Standards, Inc. (3-A SSD), www.3-a.org.

Author



W. M. (Bill) Huitt has been involved in industrial piping design, engineering and construction since 1965. His positions have included design engineer, piping design instructor, project engineer, project supervisor, piping department supervisor, engineering manager and president of W. M. Huitt Co. (P.O. Box 31154, St. Louis, MO 63131-0154; Phone: 314-966-8919; Email: wmbhuitt@aol.com), a piping consulting firm founded in 1987. His experience covers both the engineering and construction fields and crosses industry lines to include petroleum refining, chemical, petrochemical, pharmaceutical, pulp-and-paper, nuclear power, biofuel and coal gasification. He has written numerous specifications, guidelines, papers and magazine articles on the topic of pipe design and engineering. Huitt is a member of ISPE (International Society of Pharmaceutical Engineers), CSI (Construction Specifications Institute) and ASME (American Society of Mechanical Engineers). He is a member of the B31.3 committee, a member of three ASME-BPE subcommittees and several Task Groups, ASME Board on Conformity Assessment for BPE Certification where he serves as vice chair, a member of the API (American Petroleum Institute) Task Group for RP-2611, serves on two corporate specification review boards, and was on the Advisory Board for ChemInnovations 2010 and 2011, a multi-industry conference & exposition.

DILUTE-PHASE PNEUMATIC CONVEYING: Instrumentation and Conveying Velocity

Follow these guidelines
to design a well-instrumented
and controlled system, and to
optimize its conveying velocity

Amrit Agarwal
Consulting Engineer

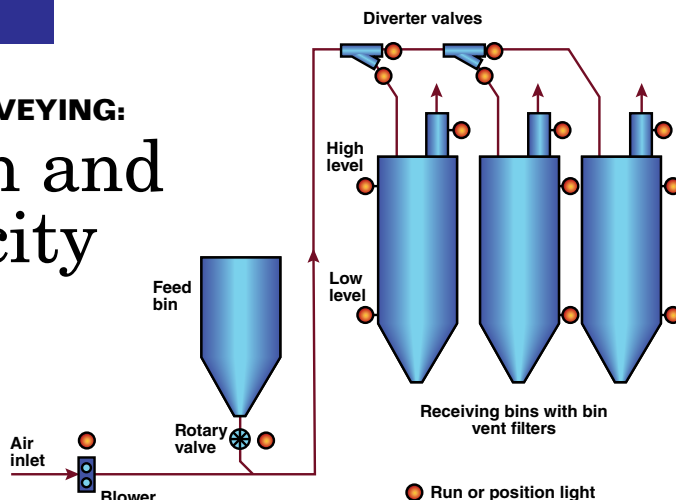

FIGURE 1. This figure is a schematic flow diagram of the conveying system with run and position lights to show the operating condition of each component of the system

Dilute-phase pneumatic conveying systems must be operated in a certain sequence and have sufficient instrumentation and operating controls to assure reliable operation and prevent problems. This article discusses two subjects that are important for successful dilute-phase conveying. Discussed below are design guidelines for instrumentation and controls that can prevent operating problems, such as pipeline plugging, downtime, equipment failure, high power consumption, product contamination and more. The article also provides a simple methodology for finding out if the presently used conveying velocity is too low or too high and for making the required changes in this velocity.

The required instrumentation depends on the degree of automation that is necessary, and whether the system is to be controlled locally or remotely. When manual control of the conveying system is used, problems can arise, especially if the operators do not have a thorough understanding of the design and of the required operating method of the conveying system, or if they do not pay close attention to day-to-day operation of the system. For conveying systems — where even a single error can result in a large financial loss — a well-instrumented and automated control system is highly recommended.

Process logic description

Feeding solids into a conveying line that does not have an airflow with sufficiently high conveying velocity will result in plugging of the line. To prevent this, solids must be fed into the conveying line only after the required airflow has been fully established. This requirement is met by allowing the solids feeder to start only after the blower has been running for at least five minutes. To do this, the rotary-valve motor should be interlocked with the blower motor so that the blower motor has run for five minutes before the rotary-valve motor can start.

When the conveying system is running, the rotary-valve motor must stop immediately in the event that the blower motor stops for any reason. If the rotary valve is not stopped, solids feed will continue and will plug the pipeline below the feeder. To remove this plug, the pipeline will need to be opened. This required control option is implemented by interlocking the rotary-valve motor with the blower motor so that the rotary-valve motor stops when the blower motor stops.

Should the conveying system need to be stopped, certain steps must be followed: The first step is to stop the solids feed, after which the blower is allowed to run until the conveying line is empty and the blower discharge pressure has come down to the empty-line pressure drop. Do

not stop the blower and the solids feed at the same time.

When a conveying cycle has been completed and the solids flow into the conveying line has been stopped, the blower motor must continue to run for at least a few more minutes to ensure that all of the solids that are still inside the conveying line have been conveyed to the destination bin. If these solids are allowed to remain in the conveying line, they may plug the line when the system is restarted. These solids may also cause contamination if a different solid is conveyed in the next cycle.

Solids feed must stop immediately if the normal operating pressure of the blower increases by 10% and continues to rise. This is because the pressure increase is most likely due to the conveying line starting to plug. If the ongoing feed stream is not stopped, the pressure will keep increasing, making the plugging situation worse.

After stopping the feed, the blower is allowed to run for about five minutes in an effort to flush the plug. If the plug does not flush out and the blower pressure remains high, the blower motor should be stopped. The plug is then removed by tapping the pipeline to find the plug location and opening up the plugged section of the pipeline.

Solids feed must also be stopped if the receiving bin or silo becomes full, as indicated by its high-level

light and alarm. If the feed is continued, the bin will overflow and the solids will back up into the conveying line, causing pluggage.

If a conveying line has diverter valves, the position of the diverter valves must be set up in a "through" mode or in a "divert" mode before starting the blower and the solids feed. If the destination bin or silo is changed for the next conveying cycle, the diverter valves position must be changed before the conveying blower and the rotary valve are started.

Graphic control panel. In the central control room, a graphic panel (Figure 1) should be provided to show a schematic diagram of the conveying system, starting from the air supply blower to the receiving bins or silos. This panel should have the following lights:

- Run lights to indicate the opera-

ing status of the blower motor and the rotary-valve motor

- Position lights to indicate the divert or through position of the diverter valves
- Position lights to indicate the low and high levels in the receiving bin or silos
- Run lights to show the operating status of the bin vent filters/dust collectors

Figure 1 shows in one glance how the conveying system has been set up, and the operating status of all components of the system.

Monitoring conveying air pressure. Conveying pressure is a key parameter in pneumatic conveying systems. It must be regularly monitored from the control room as well as locally at the blower. For measurement of the conveying pressure, a locally mounted pressure indicator should be provided at the blower discharge. If the blower

is located far away from the rotary valve, a second pressure indicator should be provided just upstream of the rotary valve.

These two measurements will show the overall pressure being provided by the blower, and the pressure drop in the conveying line. In addition to local pressure indicators, these pressure measurements should also be provided in the control room using pressure transmitters.

Digital pressure indicators are better than the analog type, because they can show the pressure much more accurately, up to two decimal points. These pressure measurements should be archived on the computer so that historical data are available if needed in the future. An alarm for high blower-discharge pressure should also be provided in the control room.

Monitoring blower discharge air

MONITOR VISCOSITY SIMPLY

SENSE MIXER MOTOR HORSEPOWER WITH UNIVERSAL POWER CELL

EASY INSTALLATION

- No holes in tanks or pipes
- Away from sensitive processes

VERSATILE

- One size adjusts to motors, from small up to 150hp
- Works on 3 phase, fixed or variable frequency, DC and single phase power

SENSITIVE

- 10 times more sensitive than just sensing amps

CONVENIENT OUTPUTS

- For meters, controllers, computers
4-20 milliamps 0-10 volts

 ALL PRODUCTS
MADE IN USA

PROFILING A PROCESS

- Power changes reflect viscosity changes
- Good batches will fit the normal "profile" for that product

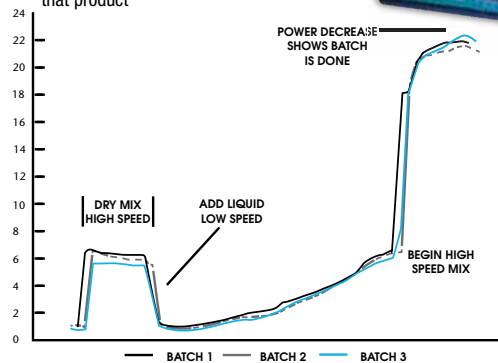

UL LISTED
IND. CONT. EQ.
6077
UL

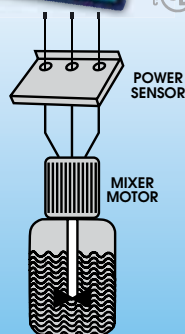

 **LOAD CONTROLS**
INCORPORATED
WWW.LOADCONTROLS.COM

CALL NOW FOR YOUR FREE 30-DAY TRIAL 888-600-3247

temperature. A locally mounted temperature indicator should be provided at the blower discharge, and also at the blower after-cooler discharge if an air cooler is used. This temperature is needed to carry out calculations for the “as-built” conveying system. If this air temperature can affect the con-

veying characteristics of solids being conveyed, it must be monitored closely.

Rotary-valve motor interlocks with the blower motor. A manually adjustable timer with a selector switch should be provided in the control room to provide three functions: 1) Automatically stop the

rotary valve if the conveying pressure starts to increase (indicating start of formation of a line plug); 2) Allow the blower motor to continue to run for the selected time, such as 10 to 15 minutes (in an effort to clear the line plug); and 3) Restart the rotary-valve motor if the conveying pressure falls to the normal pressure.

Diverter valves. Position lights are provided in the control room graphic panel to indicate if the valves are in the “through” or “divert” position.

Receiving bins. Low- and high-level lights are provided in the graphic panel for the receiving bins. An alarm should be provided in the control room to indicate high level in the bins. At the high level, the rotary valve motor should be stopped automatically.

Bin vent filters/dust collectors. The bin vent filters or the dust collectors on the bin vents must be running before the conveying system is started. A “run” light for the filter should be provided in the graphic panel.

Pressure drop indicators should be installed locally to show the pressure drop across the filter elements. Their locations should be easily accessible to the operating staff. For conveying materials that have high dust loading, alarms for low- and high-pressure drops should be provided in the control room. The low-pressure drop alarm would indicate a ruptured filter element, and the high pressure drop alarm would indicate a completely clogged filter element.

Instrumentation checklist

A summary of the instrumentation requirements, as described above, is provided below:

For the blower:

- Local and control room mounted running lights for the blower motor
- Local pressure indicator at the blower discharge
- Local temperature indicator at the blower discharge
- Local temperature indicator at the blower after-cooler discharge, for applications using a cooler



Understanding Protective Coatings in Hot Environments

The use of fireproofing, high-temperature, and other coatings to protect infrastructure in high-temperature facilities is becoming more widespread around the world. The 2014 Bring on the Heat Conference is focused on providing an informative look into how these coatings are used and how they benefit different industries. This event will provide presentations, case studies, and forum discussions on the following topics:

- Corrosion under insulation
- Thermal insulation coatings
- Thermal spray aluminum
- Passive fire protection
- Coatings needs for owners

Register Today
Register by May 16
to SAVE!

To register or for more information go to
www.nace.org/both2014

Circle 27 on p. 68 or go to adlinks.che.com/50974-27

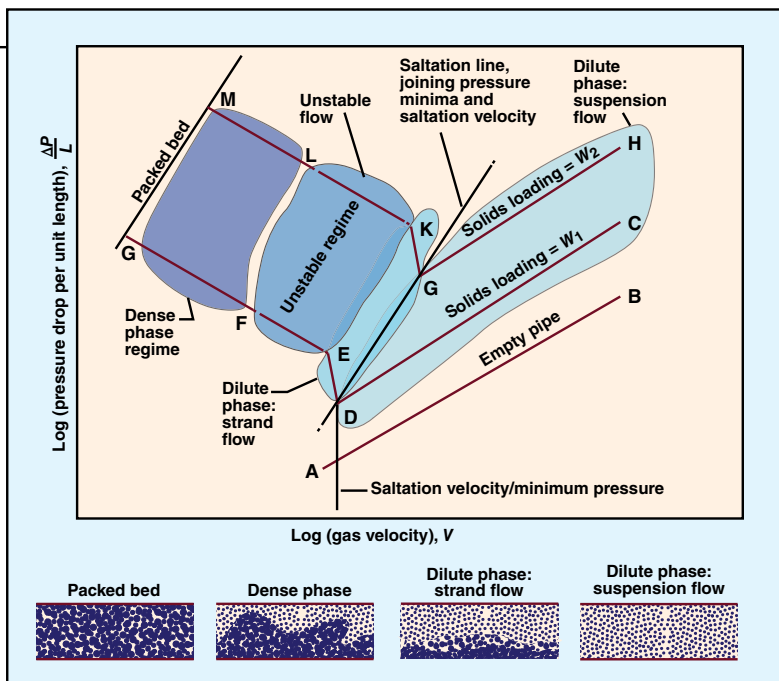

FIGURE 2. This figure shows the relationship of conveying velocity with conveying pressure at different solids-loading rates W_1 and W_2 . The solids-loading rate is the solids-conveying rate divided by the internal cross-sectional area of the conveying pipeline. For these two loading rates, the figure also shows the transition points (Points D and G) at which the conveying system migrates from dilute to dense phase. For solids-loading rate W_1 , as the conveying velocity is reduced, the conveying system's operating point moves from Point C to Point D in dilute phase; and then in the dense phase, from Point D to Points E, F and G. Similarly, for the solids-loading rate W_2 , the operating point moves from Point H to Point G in the dilute phase; and then in the dense phase from Point G to Points K, L and M

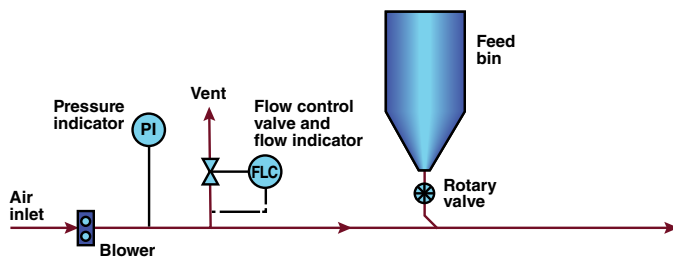

FIGURE 3. This figure shows the design of the vent air system for venting out a portion of the blower airflow to determine saltation velocity

- Pressure transmitter at the blower discharge with a pressure indicator in the control-room control panel. Computer storage of pressure data
- Control room alarm for high blower discharge pressure
- Blower motor interlocks with the rotary-valve motor

For the rotary valve:

- Local and control-room-mounted running lights for rotary valve motor
- Control-room-located, manually adjustable timer for starting and stopping the rotary valve motor

- Interlocks with the blower motor

For the diverter valves:

- Position lights to indicate "through" and "divert" positions
- Hand switches for control room operation of valve positions

Receiving bin:

- Low-level and high-level switches with indicating lights for the receiving bins
- Control room alarm to indicate high level in the bin

Bin vent filters/dust collectors:

- Running lights for the bin vent filters or dust collectors
- Local pressure-drop indicator

- Alarms for low- and high-pressure drop across filter elements (optional)

Graphic control panel:

- Graphic panel showing the conveying system route with run lights for the blower motor and rotary valve motor, position lights for the diverter valves, low- and high-level lights for the receiving bins, and run lights for the bin-vent filters

Finding the conveying velocity

Along with conveying pressure, conveying velocity is perhaps the most important variable in pneumatic conveying. After a conveying system has been installed and is going through startup, its conveying velocity should be checked to make sure it is not too low or too high, and is about equal to the conveying velocity that is required. If the conveying velocity is too low, it may cause line plugging problems; if it is too high, it will result in higher particle attrition, pipeline wear, and higher energy usage.

The conveying velocity used in the conveying system's design calculations may be too low or too high because it is difficult to find a reliable method to determine its correct value. This value depends upon many variables, such as solids particle size, bulk-solids density, solids-to-air ratio, air density, pipeline diameter and others. Presently, there are two methods to find the conveying velocity. The first method is to use equations to calculate saltation velocity (the gas velocity at which particles will fall out of the gas stream). These equations have been developed by researchers to find the impact of the above-mentioned variables on saltation velocity. As they are based on research work that is carried out in small-scale test equipment in a laboratory, they do not cover the entire range of solids and all of their properties. These equations can be found in published books and literature.

The second method is to use conveying velocity values that are available in published literature such as those given in Table 1. It should be

noted that these published values are applicable to only those pneumatic conveying systems from which they were derived, but may or may not be applicable for new conveying systems. This is because the conveying velocity for a particular conveying system depends on the values of various factors and variables such as solids particle size, particle size distribution, particle density, air density, solids conveying rate, pipeline diameter and more. As shown in Table 1, the published values may not be applicable because they do not give any information on the values of the variables on which they are based.

A proposed method

This third method is based on running a test on the as-designed and built conveying system to determine the true value of the solids saltation velocity. The value of the saltation velocity obtained by the test will be accurate because it is based on the properties of the solids being conveyed and on the as-designed and built conveying system. This value is then used to determine the value of the conveying velocity.

This test requires gradually reducing the airflow that goes into the conveying line so that the conveying velocity continues to decrease until it reaches saltation conditions. The Zenz diagram (Figure 2) shows both the dilute- and dense-phase conveying regimes, and the saltation velocity interface between them. As shown, the conveying pressure is at a minimum at the saltation velocity. In the test, the airflow and hence the conveying velocity is reduced until this minimum pressure point is reached, after which the pressure starts to increase.

The equipment required for this test is shown in Figure 3. A vent line is installed in the air-supply line at the discharge of the blower. Its purpose is to vent off to the atmosphere some of the conveying air that is being supplied by the blower. In this vent line, a flow-control valve with a flow indicator is used to control the airflow that is to be vented out. The airflow that is vented out

Material	Conveying velocity, ft/min	Material	Conveying velocity, ft/min
Alum	5,100	Malt, barley	3,300
Alumina	3,600	Oats, whole	4,200
Bentonite	3,600	Nylon, flake	4,200
Bran	4,200	Paper, chopped	4,500
Calcium carbonate	3,900	Polyethylene pellets	4,200
Clay	3,600	Polyvinylchloride, powder	3,600
Coffee beans	3,000	Rice	4,800
Coke, petroleum	4,500	Rubber pellets	5,900
Corn grits	4,200	Salt cake	5,000
Corn, shelled	3,300	Salt, table	5,400
Diatomaceous earth	3,600	Sand	6,000
Dolomite	5,100	Soda ash, light	3,900
Feldspar	5,100	Starch	3,300
Flour (wheat)	3,600	Sugar, granulated	3,600
Flourspar	5,100	Trisodium phosphate	4,500
Lime, hydrate	2,400	Wheat	3,300
Lime, pebble	4,200	Wood flour	4,000

is then subtracted from the air supplied by the blower to determine the airflow going to the conveying line. The conveying velocity is then calculated based on this airflow and pipeline diameter.

To run this test, the conveying system is started and run at full capacity for a few minutes to bring it to steady-state conditions. Keeping the solids flowrate constant, the vent valve is manually and gradually opened to start venting a few cubic feet per minute of the conveying air, reducing the conveying airflow and the conveying velocity.

A close watch is kept on the discharge-pressure indicator installed at the blower outlet. This pressure will keep falling with the decrease in airflow, but as shown in Figure 2, its value will eventually reach a point after which it will start to increase. The objective of the test is to find the airflow at that point. The vent airflow is gradually increased until this point is reached and the pressure, instead of falling, starts to increase. This is the minimum pressure point beyond which the conveying system migrates to dense-phase conveying. At this point, the solids reach their saltation velocity.

The saltation velocity value obtained by the test is increased by a safety factor of about 30% to select an appropriate value for the conveying velocity. Solids velocity always

decreases when solids flow through a bend. This decrease can be 5 to 20% depending on the properties of the solid being conveyed. Unless the conveying velocity is high enough, such a decrease can result in saltation of the solids and plugging of the bend or its downstream conveying line.

This test-derived optimum conveying velocity is compared with the velocity that is actually being used. If the actual velocity currently in use is lower, then the blower speed is increased to match the optimum conveying velocity; if it is higher, then the blower speed is decreased. The change in speed is determined from the blower performance curve. The speed change is implemented by changing the belts and sheaves of the blower. ■

Edited by Suzanne Shelley

Author



Amrit Agarwal is a consulting engineer with Pneumatic Conveying Consulting (7 Carriage Rd., Charleston, WV 25314; Email: polypcc@aol.com). He retired from The Dow Chemical Co. in 2002, where he worked as a resident pneumatic-conveying and solids-handling specialist. Agarwal has more than 40 years of design, construction, operating and troubleshooting experience in pneumatic conveying and bulk-solids-handling processes. He holds an M.S. in mechanical engineering from the University of Wisconsin, Madison, and an MBA from Marshall University (Huntington, W. Va.). He has written a large number of articles and given classes on pneumatic conveying and bulk solids handling.

Global Air-Pollution Regulations: Variation is the Norm

Operators with facilities in many countries need to focus on the requirements of each

Jim Drago
Garlock Sealing Technologies

The chemical process industries (CPI) are, by their very nature, global in scope. While chemical process operators share many common aspects (in terms of the use of chemical engineering unit operations), the location of their operation brings about different requirements when it comes to managing gaseous and particulate pollutants, because different countries have different regulations with regard to air pollution and how to control it [1].

The global regulatory climate is characterized by extremes, ranging from strict controls and enforcement at one end of the spectrum to what essentially comes down to trust that companies will do the right thing in other areas. At one end of the spectrum is the strict control model — best exemplified in the U.S., with its complex, bureaucratic and some would say impossible regulatory requirements — that typically involves regular inspection of literally tens of thousands of individual components in a typical chemical process plant.

At the other end of the spectrum is a model that is guided by trust — trust that industrial operators will be guided by a sense of corporate or social responsibility, and pressure from the media and public opinion (rather than on strict governmental guidelines and enforcement) to do the right thing.

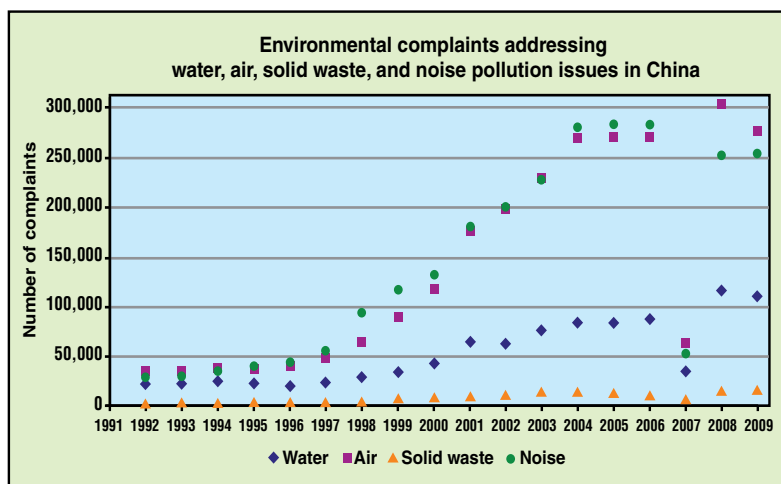

FIGURE 1. Shown here are data related to the number of environmental complaints addressing water, air, solid waste and noise pollution issues filed in China between 1992 and 2009 [2]

With that general characterization, it might be productive to compare and contrast the regulatory situations in select countries in Asia, the Middle East, Europe and the Americas. From the most-relaxed to the most-stringent regulatory environments, these include Thailand, Japan, India, China, Singapore, Saudi Arabia, Taiwan, the European Union (E.U.) and the U.S. (Table 1).

Variation by country

Thailand. In Thailand, pollution control and compliance are matters of voluntary corporate responsibility, and the country has not established limits on fugitive emission levels for individual components, such as pumps, valves and pipe flanges. However, the country has developed standards for volatile organic compounds (VOCs), which require ambient air monitoring of 44 different VOCs. Government-operated stations located throughout the country monitor ambient air quality using a variety of methods, including gas-sampling bags, canis-

ters, gas chromatography and mass spectroscopy (per EPA TO-14). Thailand is expected to enact regulations for self-monitoring, reporting and following industry-accepted technical guidelines.

Japan. In Japan, the Ministry of Environment sets acceptable ambient air quality limits, and leaves it to individual plant sites to attain them. Specifically, the Ministry sets and monitors ambient air standards, but does not require monitoring of equipment components. Companies do not apply for permits to emit certain quantities of pollutants, but are notified by the ministry as to how much they are allowed to emit. Emission limits are regulated regionally on a site-by-site basis. Individual plants are expected to attain these limits using accepted technical practices, including the best sealing and equipment technologies, along with diligent maintenance, monitoring and recordkeeping. While Japan's regulatory climate is somewhat more stringent than Thailand's, compliance is still largely voluntary, al-

beit motivated by corporate social responsibility, company honor and public backlash in the event of non-compliance.

India. India's Air Prevention and Control of Pollution Act of 1981 established a regulatory framework administered by the Ministry of Environment and Forest through a multi-layer bureaucracy that includes federal and state control boards. State boards can inspect, measure, determine compliance and check that equipment is working properly with regard to emissions. Indian citizens can also bring legal action against polluters.

Operating a plant in India requires a permit from a state board, but there is no requirement to measure emissions from specific equipment. However, each plant must report the amount of pollutants it releases. Incentives for compliance with environmental regulations include access to bank guarantees, eligibility for government subsidies for the purchase of control equipment and avoidance of costly litigation from concerned citizens.

China. In April 2000, China — recognizing the need to balance economic development and environmental protection — enacted its Atmospheric Pollution Prevention and Control Law, which states that the law is intended:

“...for the purpose of preventing and controlling atmospheric pollution, protecting and improving people's environment and the ecological environment, safeguarding humans, and promoting sustainable development of the economy and society.”

State and local governments set discharge limits, regulations and fees via a permit system. Requirements include atmospheric monitoring with public reporting. Local authorities can penalize sites, set emission limits, issue permits, perform site inspections and order plants to cease operation. Much of the authority resides with the regional environmental agencies.

China also has a complaint and petition system, known as “letters and visits,” whereby citizens can petition the government to address

Emission control technology	Country	Impetus for emission control
None specified; plant sites expected to use best practices	Thailand	Corporate social responsibility, media and public pressure Future regulations will impose more formal rules
	India	Access to bank guarantees Citizen complaints leading to litigation
	People's Republic of China	Financial penalties, risk of shut-down, media and public pressure Unique legal perspective: recognition of both environmental and economic needs
	Singapore	Corporate social responsibility, media and public pressure Risk of shut-down of operations
	Kingdom of Saudi Arabia	Violators face fines or imprisonment
	Taiwan	Prosecution by government agencies and suspension of operations
Use accepted technical practices	Japan	Corporate social responsibility, media and public pressure
Best Available Control Techniques (BACT) are published and expected to be used	E.U.	Action by local authorities, media and public pressure
LDAR programs are minutely defined and regulated. Low-emission valves and packing and their performance requirements are specified	U.S.	Fines and prosecution leading to consent decrees requiring special projects, equipment installation, additional rules and fines

pollution concerns or any other issue. Although there is minimal rule of law related to this, the government authorities are obliged to respond to all such petitions. Citizens can report polluters to government officials who can use their authority to bring them into compliance. All of this has promoted increased environmental awareness, as evidenced in the increase of environmental complaints addressing pollution issues, particularly air pollution, between 1992 and 2009 (Figure 1).

The success of policies and practices in China has traditionally relied on regional government priorities with regard to economic growth and environmental protection.

However, these priorities are beginning to change. Last November, Reuters [3] reported:

“China will steer local governments away from the pursuit of economic growth at all costs and beef up their powers to punish polluters as part of a campaign to reverse the damage done by three decades of unchecked expansion. In wide-ranging economic and social reforms unveiled last week, the ruling Communist Party said it would put more emphasis on environmental protection when assessing officials, and would also hold local authorities directly responsible for pollution.”

The stage seems to be set for future regulatory actions. The citizenry and media continue to push

for environmental action, and air monitoring and daily reporting have further raised awareness.

It should be noted that multinational companies operating in China typically comply with the requirements of their countries of origin, which typically require more extensive monitoring and control, driven by their own corporate mandates and shareholder expectations.

Singapore. The government in Singapore monitors ambient air quality, but does not require plant operators to monitor equipment emission performance. Ambient air quality is monitored with telemetric monitoring and management systems at 18 remote stations that are operated by the government.

Site inspections are conducted to ensure compliance. Non-compliant plants can be subject to special requirements, which could require monitoring of components or processes. The source emission test scheme of Singapore's National Environmental Agency requires that any air quality measurements be conducted by the site or by third-party certified consultants. Corporate social responsibility encourages the use of best practices.

Saudi Arabia. The Kingdom of Saudi Arabia's Ambient Air Standard of 2012 calls for nine pollutants to be measured and reported using methods published by the U.S. Environmental Protection Agency. The Presidency of Metrology and Environment manages air quality through a local Competent Agency (CA), which has the power to enforce or relax requirements. With access to any site for purposes of investigation, inspection, measurement and testing, the CA can prosecute offenders, resulting in fines, imprisonment or both.

Taiwan. Taiwan's Air Pollution Control Act of 2011 seeks to "control air pollution, maintain public health and the living environment and improve the quality of life." It is administered by the Taiwan Environmental Protection Authority, municipal governments and county or city authorities, all of which represent their CA administering

regulations at the federal, county and municipal levels. Regions are classified into three categories: nature preserves, those that meet air quality standards, and those that do not.

Stationary pollution sources in regions that do not meet air quality standards are required to reduce their emissions to levels determined by the central CA. Best Available Control Technology (BACT) is used to attain air quality standards. An example of BACT is the use of low-emission valves and valve seals. To verify the positive impact of BACT, the CA can require computer simulations of the BACT to demonstrate emission performance levels.

Among CA responsibilities and powers are designation and collection of permits and fees for the release of pollutants from stationary sources, investigation and prosecution, determination of emission standards, and designation of plant sites that are required to install automated air-monitoring instruments and transmit data to the CA via the Internet.

European Union. Motivated by sensitivity to cross-border pollution, the European Commission's Industrial Emissions Directive (IED) establishes directives and permits for permissible pollution levels and requires individual E.U. countries to transpose the directives into their countries' laws. The IED publishes Best Available Techniques to promote best practices for each industry, including qualification of equipment designs for low emissions. Monitoring of individual components (flanges, valves, compressors and pumps) is not the normal procedure.

A relatively new development within the E.U. is Germany's VDI-2290:2012-06 — Emission Control Sealing Constants for Flange Connections. This standard calls for analysis of flange-gasket-bolt assemblies to verify they meet the TA-Luft low-emission requirement. It also requires installation of gaskets by trained, qualified personnel and inspection of the post-installation, assembled joints.



Add value, add profit.

SOLUTIONS FOR
MULTI-NUTRIENT
FERTILISER PRODUCTION



From mixing of liquid melts and solid additives, through environmentally-friendly Rotoform pastillation, to downstream handling and bagging, our continuous process solutions open the door to new possibilities in profitable, innovative and effective multi-nutrient fertilisers.

- Inline mixing of liquid and solid suspensions
- Uniform, dust-free Rotoform pastilles
 - Ultra-versatile production for easy product switchover
- Low investment, low operating costs
- Single source, end-to-end capability

Contact us to find out how
we can enhance your products.

SANDVIK

Sandvik Process Systems

Division of Sandvik Materials Technology Deutschland GmbH

Salierstr. 35, 70736 Fellbach, Germany

Tel: +49 711 5105-0 · Fax: +49 711 5105-152

info.spds@sandvik.com

www.processsystems.sandvik.com

Circle 40 on p. 68 or go to adlinks.che.com/50974-40



The premier conference for Turbomachinery and Pump professionals
DEVELOPED FOR THE INDUSTRY, BY THE INDUSTRY.



**43rd Turbomachinery
30th Pump SYMPOSIA**

GEORGE R. BROWN CONVENTION CENTER
HOUSTON, TX | SEPT. 22 - 25, 2014

EXHIBIT

Generate leads and close deals.

Network with over 5500 international pump and turbomachinery professionals gathered in one location.

Meet with decision makers; 70% of attendees make or influence final purchasing decisions.

For more information on exhibiting email
exhibit@turbo-lab.tamu.edu
or visit **PUMPTURBO.TAMU.EDU**



TEXAS A&M
UNIVERSITY



**TURBOMACHINERY
LABORATORY**
TEXAS A&M ENGINEERING EXPERIMENT STATION

Circle 45 on p. 68 or go to adlinks.che.com/50974-45

United States. The U.S. provides the most stringent regulatory environment, in terms of the required standards and enforcement activities. For instance, the emission levels of certain individual components may not exceed 100, 250 or 500 ppm, depending upon location or special plant site regulations. Monitoring is conducted using organic vapor analyzers (Method 21) or forward-looking infrared (FLIR) cameras. U.S. regulations also dictate repair requirements and reporting requirements to local, state and federal agencies.

EPA may impose Enhanced Leak Detection and Repair (LDAR) requirements on plants that are not carrying out the normal LDAR requirements properly. These requirements can involve equipment upgrades or replacement. Among the requirements are use of low-leak valves and packing technology — the latter being a regulatory first. Also required are written guarantees that the valve will not leak above 100 ppm for five years, or test reports indicating that leak performance not exceeding 100 ppm is attainable for at least five years.

A 2013 article by Cynthia Giles [4], EPA Assistant Administrator for Enforcement and Compliance Assurance, promotes the use of current and new technologies to motivate compliance and optimize enforcement:

“We are moving toward a world

in which states, EPA, citizens and industry will have real-time electronic information regarding environmental conditions, emissions and compliance, and we are using what we have learned about compliance to make it easier to comply than to violate.”

Looking forward

What does the future hold? The U.S. is increasingly becoming a model for other countries' regulatory frameworks. Contributing to this trend is the fact that U.S. multi-national companies tend to abide by U.S. standards as part of corporate policy, regardless of the countries where they operate (demonstrating that it is possible to operate a plant competitively and act responsibly toward the environment). There is also growing realization among developing nations, such as China, that economic development and environmental protection can no longer be mutually exclusive, but must be balanced for the long-term sustainability of both. In the final analysis, more-stringent regulations and stricter enforcement alone cannot improve air quality. These actions must be accompanied by a heightened sense of corporate responsibility on the part of polluters and a commitment to do the right thing to benefit their own community, nation and ultimately the world. ■

Edited by Suzanne Shelley

References

1. Drago, J., Air Pollution Rules — World and USA Leak Detection and Repair, AchemAsia 2013, Beijing, China, May 14, 2013.
2. Yang, T., Comparative Overview of China's Environmental Complaint System and the U.S. Citizen Suit System and Lessons, “China Environmental Yearbook,” 1993–2010.
3. Stanway, D., To Tackle Pollution, China to Steer Local Governments Away from Growth at All Costs, Beijing-Reuters, Published November 18 2013 (Accessed at: <http://www.reuters.com/article/2013/11/18/us-china-reform-environment-idUSBRE9AH07M20131118>).
4. Giles, C., Next Generation Compliance, The Environmental Forum, September-October 2013.

Author



Jim Drago has worked in sealing technology for over 30 years, and is currently a principal applications engineer for Garlock Sealing Technologies (Phone: 800-448-6688; Email: jim.drago@garlock.com). He is a licensed professional engineer in the state of New York. Drago's work has focused on applications, product engineering, engineering management and global business development. He has authored numerous articles and presented papers at technical symposia on sealing to meet fugitive emissions regulations and sealing product selection. He also has contributed to the industry standards of the American Petroleum Institute (API), American Society of Mechanical Engineers (ASME), Electric Power Research Institute (EPRI), and Society of Tribologists and Lubrication Engineers (STLE). Drago is a former member of ASME BPE Standard committees on sealing and polymers.

RESULT DRIVEN

INNOVATION

solving complex
chemical processing
flow control demands.

Valving



Filtration



Special applications



Quality crafted
from stainless
steel aluminum,
brass and steel.

We'll design, test and
manufacture or build to
your specifications!



**Fluid Line
Products, Inc.**

Designer and Manufacturer of Fluid Transfer Components

(440) 946-9470 Fax: (440) 946-9472

flp@fluidline.com

www.fluidline.com

Circle 14 on p. 68 or go to adlinks.che.com/50974-14

CHEMICAL ENGINEERING

COMING IN APRIL...

HOT PRODUCTS

THE PREMIUM SHOWCASE FOR
THE LATEST PRODUCTS AND
TECHNOLOGIES IN THE CHEMICAL
PROCESSING INDUSTRIES.

TO SUBSCRIBE TO THE E-LETTER, PLEASE CONTACT

CRISTANE MARTIN

CMARTIN@ACCESSINTEL.COM

An unexpected safety lesson

About thirty years ago, my golf foursome learned an important safety lesson and we credited the Dalai Lama. We were all big fans of the movie "Caddyshack." In that movie, Bill Murray's character talks about caddying in the Himalayans for the Dalai Lama and states, "So I'm on the first tee with him. I give him the driver. He hauls off and whacks one — big hitter, the Lama — long — into a ten thousand foot crevasse, right at the base of this glacier."

In response to that movie, my friend Dave invented a golf shot that he called his Dalai Lama Shot. He positioned the golf ball at his rear foot. He choked way down on his sand wedge. He swung. The golf ball would go vertically about 75 yards up and horizontally about 50 yards out and then the ball would do a little dance on a hard green. One day, while executing the Dalai Lama Shot for an appreciative audience, Dave's golf ball hit Dave in his left ear, luckily not in his face. Dave and his friends had never thought about the safety aspects of the shot. If we had, we would have easily realized that the shot was dangerous.

Sometimes, the most important aspect of a safety program — thinking — is the aspect most lacking. Our staffs become consumed by paperwork, such as programs, policies, procedures and forms to be filled out. Back in the 1980s, I was a proponent of DuPont's "Take Two" safety program. That program insisted that all dangerous acts be preceded by at least two minutes of thought. What a concept!

I remember attempting to teach "Take Two" to my teenaged sons around the house. I remember standing in the backyard around a clogged lawnmower with them. What could happen if we did not shut the engine off? What if we shut the engine off and moved the blade around with a small shovel? What if we detached the spark plug wire and the wire broke free and re-touched the spark

plug? What if we tipped the mower a certain way and gasoline spilled out onto a hot engine. (We concluded, by the way, that the safest thing to do was to buy a new lawnmower, which was not in my budget that month.)

Whenever FRI staff members perform tasks that are unusual, they effect job safety analyses (JSAs) including the associated paperwork. We identify hazards. We discuss solutions to those hazards. We often purchase new tools. We are willing to walk away from projects where we are not completely comfortable, and such projects are handed off to expert contractors. The most important component of any JSA is thinking.

In fact, the most important component of every safety program is thought. Thinking does not hurt; not thinking can lead to hurt. The next time that you encounter an unsafe situation, at your job or elsewhere, just remember the Dalai Lama Shot and the clogged lawnmower. ■

Mike Resetarits



Mike Resetarits is the technical director at Fractionation Research, Inc. (FRI; Stillwater, Okla.; www.fri.org), a distillation research consortium. Each month, Mike shares his first-hand experience with CE readers

D-40211 Düsseldorf
 Louise-Dumont-Straße 25
 ☎ +49 (0)2 11 / 15 97 76-0
 Fax +49 (0)2 11 / 15 97 76-10
 E-Mail: info@industriewert.de
 Web: www.industriewert.de

INDUSTRIE WERT
 Sachverständige und Versteigerer
 für die Industrie

AUCTION

Production plant of the pharmaceutical manufacturer

Weimer Pharma GmbH

Im Steingerüst 30, D-76437 Rastatt/Germany

11 March and 12 March 2014, starting at 10 am each day

Approx. 1.200 items up to 2013 models; Manufacturing plant and machinery for the manufacture of solid and liquid medicaments and preparations: Tablets, coated tablets, pills, syrups, drops, solutions, injections in phial and carpule form and configuration, packaging, labelling; filling plant / lines for round objects (bottles); phial / carpule filling plant, blister packaging lines; phial packaging machines; make DIVIDALLA, 90 pcs./min.; fully automated phial and carpule inspection machines, make INNOSCAN, model 2009, max. 36,000 pcs./h with label printing machines/splicing equipment; tablet presses; mixing equipment; tablet sorting plant; tablet dedusting plant; granulating machine; coating, mixing and suspension tanks; pressure and mixing vessels; electr. mixers, mixing container up to 2,000 litres; hot water and steam sterilisation; laboratory equipment, e.g. approx. 20 HPLC systems; gas chromatography system; blister test equipment; crack test and inspection machines; test weight kits; analysis equipment; measuring and test instruments; fine, precision, inspection and floor scales; centrifuges; air samplers, particle measuring instruments; headspace gas analyser; steam boiler system; pendulum water softening system; pure water degassing system; ultrapure steam generator; serial dedusting plant; central exhaust system for production and many other items!

Viewing: Saturday, 8 March 2014, from 9 am to 3 pm and
 Monday, 10 March 2014, from 9 am to 5 pm and on the
 auction days from 8 – 9.45 am

Full auction catalogue upon request and at www.industriewert.de

Circle 47 on p. 68 or go to adlinks.che.com/50974-47

O TEK™ CORP.



Technology Bargraph Meter

Replace analogs with OTEK's Powerless™ meters.

Just connect in parallel and disconnect old.

- Signal Powered (4-20mA & A.C.)
- Signal Failure Detection
- Isolated Serial I/O

LPD-X
(4.3"x3.9")

Auto-Tricolor
Bargraph



Phone: (520)748-7900
Email: sales@otekcorp.com
www.otekcorp.com



Circle 203 on p. 68 or go to adlinks.che.com/50974-203

Process Technology Grinding



NEUHAUS NEOTEC

www.neuhaus-neotec.de

Circle 202 on p. 68 or go to adlinks.che.com/50974-202

When a plugged drain line would mean disaster...



Model A100
Plug Resistant
Orifice for critical
drain lines



CU Services LLC

725 Parkview Cir,
Elk Grove Vlg, IL 60007
Phone 847-439-2303
rcronfel@cuseservices.net
www.cuseservices.net

Circle 201 on p. 68 or go to adlinks.che.com/50974-201

SOFTWARE

12/7/11 12:30



- New module for plate-fin exchangers: *Xpfe*®
- New materials of construction database
- Significantly improved graphing capabilities
- Many new and improved features in *Xist*® including

- X Ten new methods backed by proprietary research
- X New data entry form based on TEMA input sheet
- X Enhanced tube layout capabilities backed by ASME mechanical design
- X 3D visualization of exchangers

HTRI

We're changing the future of heat transfer™

www.htri.net

Circle 244 on p. 68 or go to adlinks.che.com/50974-244

www.ae-sim.com
Process Simulators

Material Balance - Process Control
Power Plant Steam Cycles
Free Demo Downloads

Circle 241 on p. 68 or go to adlinks.che.com/50974-241

Engineering e-material, e-solutions, e-courses and e-seminars for energy conversion systems:

- Physical Properties
- Power Cycles
- Compressible Flow
- Steam Approximations
- Power Cycle Components/Processes

ENGINEERING SOFTWARE

Phone/FAX: (301) 540-3605
Web Site: <http://www.engineering-4e.com>
Visit the web site to check out free demos, etc.!

Circle 242 on p. 68 or go to adlinks.che.com/50974-242

GET CONNECTED TODAY

www.che.com

NEW & USED EQUIPMENT

WABASH SELLS & RENTS

Boilers

20,000 - 400,000 #/Hr.
Diesel & Turbine Generators
 50 - 25,000 KW
Gears & Turbines
 25 - 4000 HP

We stock large inventories of:

Air Pre-Heaters • Economizers • Deaerators
 Pumps • Motors • Fuel Oil Heating and Pump Sets
 Valves • Tubes • Controls • Compressors
 Pulverizers • Rental Boilers & Generators

24/7 Fast Emergency Service

800-704-2002

Phone: 847-541-5600 Fax: 847-541-1279

www.wabashpower.com

wabash POWER EQUIPMENT CO.
 444 Carpenter Ave., Wheeling, IL 60090

Circle 250 on p. 68 or go to
adlinks.che.com/50974-250

Stop dry start problems with
 Vesconite Hilube bushings



- Low friction
- No swell
- Increase MTBR
- Reduce electricity
- Quick supply

CALL FOR
 SAMPLE

Tel: +27 11 616 11 11
vesconite@vesconite.com
www.vesconite.com

Circle 249 on p. 68 or go to
adlinks.che.com/50974-249

ADVERTISE IN THE CLASSIFIED

Contact Diane Burleson

Tel: 512-337-7890

Fax: 512-213-4855

Email: dburleson@accessintel.com

SOFTWARE

**VisiMix Saves Millions
 of Dollars per Year**
 VisiMix Mixing Simulations
 deliver proven return on investment.

User friendly mixing simulations for
 chemical engineers, process engineers,
 and chemists deliver fast results.

Now available: VisiMix RSD
 Rotor Stator Dispenser for high-shear
 mixing.

See how customers are successfully using
 Visimix. Contact Marcie Forrest for a live demo
 at marcie@visimix.com
 or call +972 512 5813 4174

Visit our website
 and download our
 free demo at

visimix.com



Circle 252 on p. 68 or go to
adlinks.che.com/50974-252

CONTROL SYSTEMS

Recipe-controlled. IQ/OQ. CIP/SIP.
 Fast design/install. Reliable support.



Scan to learn more
 & get a free quote.

Free Tag Reader:
<http://gettag.mobi>

1-866-797-2660

www.RossSysCon.com



Circle 248 on p. 68 or go to
adlinks.che.com/50974-248

GET CONNECTED TODAY

www.che.com

CONSULTING

NOISE MEASUREMENT, ASSESSMENT, AND CONTROL • COMPUTER NOISE MODELING
HFP ACOUSTICAL CONSULTANTS

NOISE CONTROL ENGINEERING

HOUSTON, TEXAS | CALGARY, AB

(713) 789-9400 | (403) 259-6600

www.HFPacoustical.com/CE

Circle 245 on p. 68 or go to
adlinks.che.com/50974-245

CRYSTALLIZATION & PRECIPITATION



Dr. Wayne J. Genck

Genck International

3 Somonauk Court, Park Forest, IL. 60466

Tel (708) 748-7200 Fax (708) 748-7208

genckintl@aol.com - <http://www.genckintl.com>

- Design/Scale-up
- Purity
- Size Distribution
- Caking
- Laboratory Investigations
- Drying
- Filtration
- Particle Habit
- Troubleshooting
- Polymorphism
- Product Micro-Analysis
- Kinetics Studies

◆◆◆ Industrial Seminars ◆◆◆

Circle 243 on p. 68 or go to
adlinks.che.com/50974-243

BOILERS

Available Immediately



Lease • Rental • Sale

(2) New 250,000 PPH 800 PSI /
 750 Deg. S.H. with Low NOx Burners

250,000-850 PSI / 750 Deg. F.	Trailer Mounted
250,000-750 PSI / 750 Deg. F.	80K-395 PSI
180,000-750 PSI / 750 Deg. F.	72K-350 PSI
165,000-1025 PSI / 850 Deg. F.	70K-350 PSI
165,000-350 PSI	60K-750 PSI
150,000-750 PSI / 750 Deg. F.	45K-750 PSI
135,000-750 PSI / 750 Deg. F.	40K-350 PSI
120,000-350 PSI	36K-300 PSI
120,000-725 PSI / 750 Deg. F.	30K-300 PSI
110,000-350 PSI	24K-300 PSI
90,000-395 PSI	
75,000-395 PSI	
70,000-350 PSI	
60,000-750 PSI / 750 Deg. F.	
50,000-350 PSI	
40,000-750 PSI	
40,000-350 PSI	
30,000-350 PSI	
20,000-1600 PSI	
10-1,000 HP - 15-250 PSI	

INDECK

Indeck Power Equipment Company

tel 847.541.8300 / 800.446.3325

info@indeck-power.com

www.indeck.com

Circle 246 on p. 68 or go to
adlinks.che.com/50974-246

KnightHawk Engineering

Specialists in design, failure analysis
 and troubleshooting of static
 and rotating equipment
www.knighthawk.com
 Contact Jim Salter 281-282-9200

Circle 247 on p. 68 or go to
adlinks.che.com/50974-247

HEAT EXCHANGERS

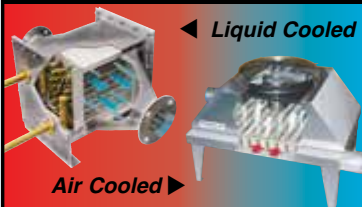

FOR GASES & LIQUIDS!

Talk Directly with Design Engineers!
 Blower Cooling Vent Condensing

INDUSTRIAL HEAT EXCHANGERS
XCHANGER

(952) 933-2559 info@xchanger.com

Circle 251 on p. 68 or go to
adlinks.che.com/50974-251

JustFAXit! or go to www.che.com/adlinks

Fill out the form and circle or write in the number(s) below, cut it out, and fax it to 800-571-7730.

Go on the Web and fill out the online reader service card.



Name _____ Title _____
 Company _____
 Address _____
 City _____ State/Province _____ Zip/Postal Code _____
 Country/ _____ Telephone _____ Fax _____
 Email _____

FREE PRODUCT INFO
 (please answer all the questions)

YOUR INDUSTRY

- 01 Food & Beverages
- 02 Wood, Pulp & Paper
- 03 Inorganic Chemicals
- 04 Plastics, Synthetic Resins
- 05 Drugs & Cosmetics
- 06 Soaps & Detergents
- 07 Paints & Allied Products
- 08 Organic Chemicals
- 09 Agricultural Chemicals
- 10 Petroleum Refining, Coal Products
- 11 Rubber & Misc. Plastics
- 12 Stone, Clay, Glass, Ceramics
- 13 Metallurgical & Metal Products

- 14 Engineering, Design & Construction Firms
- 15 Engineering/Environmental Services
- 16 Equipment Manufacturer
- 17 Energy incl. Co-generation
- 18 Other _____

JOB FUNCTION

- 20 Corporate Management
- 21 Plant Operations incl. Maintenance
- 22 Engineering
- 23 Research & Development
- 24 Safety & Environmental
- 26 Other _____

EMPLOYEE SIZE

- 28 Less than 10 Employees

- 29 10 to 49 Employees
- 30 50 to 99 Employees
- 31 100 to 249 Employees
- 32 250 to 499 Employees
- 33 500 to 999 Employees
- 34 1,000 or more Employees

YOU RECOMMEND, SPECIFY, PURCHASE
 (please circle all that apply)

- 40 Drying Equipment
- 41 Filtration/Separation Equipment
- 42 Heat Transfer/Energy Conservation Equipment
- 43 Instrumentation & Control Systems
- 44 Mixing, Blending Equipment
- 45 Motors, Motor Controls
- 46 Piping, Tubing, Fittings

- 47 Pollution Control Equipment & Systems
- 48 Pumps
- 49 Safety Equipment & Services
- 50 Size Reduction & Agglomeration Equipment
- 51 Solids Handling Equipment
- 52 Tanks, Vessels, Reactors
- 53 Valves
- 54 Engineering Computers/Software/Peripherals
- 55 Water Treatment Chemicals & Equipment
- 56 Hazardous Waste Management Systems
- 57 Chemicals & Raw Materials
- 58 Materials of Construction
- 59 Compressors

1	16	31	46	61	76	91	106	121	136	151	166	181	196	211	226	241	256	271	286	301	316	331	346	361	376	391	406	421	436	451	466	481	496	511	526	541	556	571	586
2	17	32	47	62	77	92	107	122	137	152	167	182	197	212	227	242	257	272	287	302	317	332	347	362	377	392	407	422	437	452	467	482	497	512	527	542	557	572	587
3	18	33	48	63	78	93	108	123	138	153	168	183	198	213	228	243	258	273	288	303	318	333	348	363	378	393	408	423	438	453	468	483	498	513	528	543	558	573	588
4	19	34	49	64	79	94	109	124	139	154	169	184	199	214	229	244	259	274	289	304	319	334	349	364	379	394	409	424	439	454	469	484	499	514	529	544	559	574	589
5	20	35	50	65	80	95	110	125	140	155	170	185	200	215	230	245	260	275	290	305	320	335	350	365	380	395	410	425	440	455	470	485	500	515	530	545	560	575	590
6	21	36	51	66	81	96	111	126	141	156	171	186	201	216	231	246	261	276	291	306	321	336	351	366	381	396	411	426	441	456	471	486	501	516	531	546	561	576	591
7	22	37	52	67	82	97	112	127	142	157	172	187	202	217	232	247	262	277	292	307	322	337	352	367	382	397	412	427	442	457	472	487	502	517	532	547	562	577	592
8	23	38	53	68	83	98	113	128	143	158	173	188	203	218	233	248	263	278	293	308	323	338	353	368	383	398	413	428	443	458	473	488	503	518	533	548	563	578	593
9	24	39	54	69	84	99	114	129	144	159	174	189	204	219	234	249	264	279	294	309	324	339	354	369	384	399	414	429	444	459	474	489	504	519	534	549	564	579	594
10	25	40	55	70	85	100	115	130	145	160	175	190	205	220	235	250	265	280	295	310	325	340	355	370	385	400	415	430	445	460	475	490	505	520	535	550	565	580	595
11	26	41	56	71	86	101	116	131	146	161	176	191	206	221	236	251	266	281	296	311	326	341	356	371	386	401	416	431	446	461	476	491	506	521	536	551	566	581	596
12	27	42	57	72	87	102	117	132	147	162	177	192	207	222	237	252	267	282	297	312	327	342	357	372	387	402	417	432	447	462	477	492	507	522	537	552	567	582	597
13	28	43	58	73	88	103	118	133	148	163	178	193	208	223	238	253	268	283	298	313	328	343	358	373	388	403	418	433	448	463	478	493	508	523	538	553	568	583	598
14	29	44	59	74	89	104	119	134	149	164	179	194	209	224	239	254	269	284	299	314	329	344	359	374	389	404	419	434	449	464	479	494	509	524	539	554	569	584	599
15	30	45	60	75	90	105	120	135	150	165	180	195	210	225	240	255	270	285	300	315	330	345	360	375	390	405	420	435	450	465	480	495	510	525	540	555	570	585	600

If number(s) do not appear above, please write them here and circle: _____

Fax this page back to 800-571-7730

ADVERTISING SALES REPRESENTATIVES

North America

Terry Davis
 Sales Director
 Chemical Engineering
 2276 Eastway Rd., Decatur, GA 30033
 Tel: 404-634-5123; Fax: 832-201-8823 E-mail: tdavis@che.com
 Alabama, Canada, Connecticut, Delaware, Georgia, Idaho, Kentucky, Latin America, Maine, Maryland, Massachusetts, Mississippi, Montana, Nebraska, New Hampshire, New Jersey, New York, North and South Carolina, North and South Dakota, Ohio, Oregon, Pennsylvania, Rhode Island, Tennessee, Utah, Vermont, Virginia, Washington D.C., West Virginia, Wyoming

Jason Bullock,
 District Sales Manager
 Chemical Engineering
 8325 Broadway, Ste. 202/PMB 261
 Pearland, TX 77581
 Tel: 281-485-4077; Fax: 281-485-1285
 E-mail: jbullock@che.com
 Arizona, Arkansas, California, Colorado, Florida, Kansas, Louisiana, Missouri, Nevada, New Mexico, Oklahoma, Texas, Washington

Dan Gentile
 District Sales Manager
 Tel: 512-918-8075
 E-mail: dgentile@che.com
 Alaska, Hawaii, Illinois, Indiana, Iowa, Michigan, Minnesota, Wisconsin,

Diane Burleson
 Inside Sales Manager
 Chemical Engineering;
 11000 Richmond Ave, Suite 690,
 Houston, TX 77042
 Tel: 512-337-7890
 E-mail: dburleson@che.com
 Product Showcase,
 Literature Reviews,
 Classified Display Advertising

International

Petra Trautes
 Chemical Engineering
 Zeilweg 44
 D-60439 Frankfurt am Main
 Germany
 Phone: +49-69-58604760
 Fax: +49-69-5700-2484
 Email: ptrautes@che.com
 Austria, Czech Republic, Benelux,
 Eastern Europe, Germany, Scandinavia,
 Switzerland, United Kingdom

Dipali Dhar
 Chemical Engineering
 88 Pine Street, 5th floor, New York, NY 10005
 Tel: 718-263-1162
 E-mail: ddhar@accessintel.com
 India
Katshuhiro Ishii
 Chemical Engineering
 Ace Media Service Inc., 12-6, 4-chome
 Nishiiko, Adachi-ku, Tokyo 121, Japan
 Tel: 81-3-5691-3335; Fax: 81-3-5691-3336
 E-mail: amskatsu@dream.com
 Japan

Ferruccio Silvera
 Chemical Engineering
 Silvera Pubblicita
 Viale Monza, 24 Milano 20127, Italy
 Tel: 39-02-284-6716;
 Fax: 39-02-289-3849
 E-mail: ferruccio@silvera.it/www.silvera.it
 Andorra, France, Gibraltar, Greece,
 Israel, Italy, Portugal, Spain

Rudy Teng
 Sales Representative
 Chemical Engineering;
 8F-1 #181 Wulin Road
 Hsinchu 30055 Taiwan
 Tel: +86 13818181202, (China),
 +886 921322428 (Taiwan)
 Fax: +86 21 54183567
 E-mail: rudy.teng@gmail.com
 Asia-Pacific, Hong Kong, People's
 Republic of China, Taiwan

Advertisers' Index

Advertiser Phone number	Page number Reader Service #
Abbe, Paul O. 1-800-524-2188 <i>adlinks.che.com/50974-02</i>	6
* Alexanderwerk GmbH 49 (0) 2191 795-0 <i>adlinks.che.com/50974-03</i>	32I-2
American Filtration and Separations Society <i>adlinks.che.com/50974-04</i>	30
AUMA Riester GmbH & Co. KG <i>adlinks.che.com/50974-05</i>	23
BASF <i>adlinks.che.com/50974-06</i>	4
* Berndorf Band GmbH 39 0331/864841 <i>adlinks.che.com/50974-07</i>	32I-11
Beumer Group GmbH & Co. KG <i>adlinks.che.com/50974-08</i>	15
* Bronkhorst High-Tech BV <i>adlinks.che.com/50974-09</i>	32I-2
Carver Pump Company 1-563-263-3410 <i>adlinks.che.com/50974-10</i>	18
Corzan HP Piping Systems 1-855-735-1431 <i>adlinks.che.com/50974-23</i>	21
* Donadon SDD 39 02 90111001 <i>adlinks.che.com/50974-11</i>	32I-9
Emerson Process Management	FOURTH COVER
Fluid Line Products 1-440-946-9470 <i>adlinks.che.com/50974-14</i>	63
Fluid Metering, Inc. 1-800-223-3388 <i>adlinks.che.com/50974-15</i>	9
FREWITT Fabrique de Machines SA <i>adlinks.che.com/50974-16</i>	9
* GEA Process Engineering A/S 45 39 54 54 54 <i>adlinks.che.com/50974-17</i>	32I-3
* GEA Wiegand GmbH 49 7243 705-0 <i>adlinks.che.com/50974-18</i>	32I-13
GIG Karasek GmbH 43 2662 42780 <i>adlinks.che.com/50974-19</i>	25
IndustrieWert GmbH 49 (0)2 11 / 15 97 76-0 <i>adlinks.che.com/50974-47</i>	65
* Italvacuum 39 011 470 4651 <i>adlinks.che.com/50974-20</i>	32I-1
Kral AG 43/5577/86644-0 <i>adlinks.che.com/50974-21</i>	28
Load Controls 1-888-600-3247 <i>adlinks.che.com/50974-22</i>	55
* International Edition	

Advertiser Phone number	Page number Reader Service #
* Microdyn-Nadir GmbH 49 611 962 6001 <i>adlinks.che.com/50974-24</i>	32I-15
Miller-Stephenson 1-800-992-2424 <i>adlinks.che.com/50974-25</i>	6
Müller GmbH 49 (0) 7623/969-0 <i>adlinks.che.com/50974-26</i>	8
NACE International <i>adlinks.che.com/50974-27</i>	56
NOV Fiber Glass Systems <i>adlinks.che.com/50974-28</i>	27
Paharpur Cooling Towers Ltd. 91-33-4013 3000 <i>adlinks.che.com/50974-29</i>	29
Pentair Separation Systems 1-888-896-6300 <i>adlinks.che.com/50974-30</i>	24
* Pepperl & Fuchs <i>adlinks.che.com/50974-31</i>	32I-6
* Phoenix Contact 49 52 35 3-00 <i>adlinks.che.com/50974-32</i>	32I-5
* Pompetravaini Spa 39.0331.8889000 <i>adlinks.che.com/50974-33</i>	32I-7
PTXi 2014 <i>adlinks.che.com/50974-34</i>	52
Quest Integrity Group 1-253-893-7070 <i>adlinks.che.com/50974-35</i>	51
RedGuard 1-855-REDGUARD <i>adlinks.che.com/50974-01</i>	SECOND COVER

Advertiser Phone number	Page number Reader Service #
Rembe GmbH 49 (0) 29 61-74050 <i>adlinks.che.com/50974-36</i>	51
Saint-Gobain Ceramics 1-716-278-6233 <i>adlinks.che.com/50974-37</i>	32
Samson AG 49 69 4009-0 <i>adlinks.che.com/50974-38</i>	13
Sandvik Materials Technology <i>adlinks.che.com/50974-39</i>	16
Sandvik Process Systems 49 711 5105-0 <i>adlinks.che.com/50974-40</i>	61
SoundPLAN International LLC 1-360-432-9840 <i>adlinks.che.com/50974-41</i>	8
Sturtevant Inc. 1-800-992-0209 <i>adlinks.che.com/50974-42</i>	7
Team Industrial Services 1-713-378-8600 <i>adlinks.che.com/50974-43</i>	38
ThyssenKrupp Industrial Solutions AG (form. Uhde) <i>adlinks.che.com/50974-44</i>	19
Tiger Tower, an EMCOR Industrial Services company 1-281-951-2500 <i>adlinks.che.com/50974-12</i>	3
Turbomachinery Laboratory <i>adlinks.che.com/50974-45</i>	62
United Rentals <i>adlinks.che.com/50974-46</i>	10

Classified Index March 2014

Advertiser Phone number	Page number Reader Service #
Applied e-Simulators Software <i>adlinks.che.com/50974-241</i>	66
CU Services LLC 1-847-439-2303 <i>adlinks.che.com/50974-201</i>	66
Engineering Software 1-301-540-3605 <i>adlinks.che.com/50974-242</i>	66
Genck International 1-708-748-7200 <i>adlinks.che.com/50974-243</i>	67
Heat Transfer Research, Inc. <i>adlinks.che.com/50974-244</i>	66
HFP Acoustical Consultants 1-713-789-9400 <i>adlinks.che.com/50974-245</i>	67
Indeck Power Equipment Co. 1-847-541-8300 <i>adlinks.che.com/50974-246</i>	67
KnightHawk Engineering 1-281-282-9200 <i>adlinks.che.com/50974-247</i>	67
Neuhaus Neotec <i>adlinks.che.com/50974-202</i>	66

Advertiser's Product Showcase . . .	66
Computer Software	66, 67
Consulting	67
Equipment, New & Used	67

Advertiser Phone number	Page number Reader Service #
Otek Corporation 1-520-748-7900 <i>adlinks.che.com/50974-203</i>	66
Ross, Charles & Son Company 1-800-243-ROSS <i>adlinks.che.com/50974-248</i>	67
Vesconite Bearings 27 11 616 11 11 <i>adlinks.che.com/50974-249</i>	67
VisiMix 972 52 383 4174 <i>adlinks.che.com/50974-252</i>	67
Wabash Power Equipment Co. 1-800-704-2002 <i>adlinks.che.com/50974-250</i>	67
Xchanger, Inc. 1-952-933-2559 <i>adlinks.che.com/50974-251</i>	67

See bottom of opposite page
for advertising
sales representatives'
contact information



Send Advertisements and Box replies to: **Diane Burleson**
Chemical Engineering, 11000 Richmond Ave, Houston, TX 77042
E-mail: dburleson@che.com Tel: 512-337-7890

People

MARCH WHO'S WHO



Festge

Novasep (Pompey, France), a supplier to the life sciences industry, welcomes *Thierry Van Nieuwenhove* as president of the company's synthesis business unit.

Robert Kumpf becomes CTO of specialty chemicals producer **Elevance Renewable Sciences** (Woodridge, Ill.).

Chicago Pneumatic (Rock Hill, S.C.) names *Jean-Christophe (JC) Lecocq* senior vice president for Mexico, Canada and U.S. sales and operations.



Kerin

At **Haver & Boecker** (Oelde, Germany), *Florian Festge* and *Fabian Festge* have taken over management of the company's machinery division, while their father *Reinhold Festge* (photo) has started a three-year term as president at the Verband Deutscher Maschinen- und Anlagenbau (VDMA; Assn. of German Machinery and Plant Manufacturers).

Trish Kerin becomes director of the **Institution of Chemical Engineers'** (ICHEME; Rugby, U.K.) new safety center in Melbourne, Australia.



Schuster



DiBiano

Integrated Project Services Inc. (IPS; Blue Bell, Pa.), an engineering, construction and commissioning firm specializing in pharmaceutical and biotechnology projects, names *Tim Schuster* director of process engineering, *Frank DeBiano* project executive in its construction division, and *Peter Hanson* director of process architecture in Asia, Europe, the Middle East and Africa.

Philadelphia Mixing Solutions Ltd. (King of Prussia, Pa.) names *Mark Self* CEO. ■

Suzanne Shelley



Self

SUBSCRIBE SUBSCRIBE SUBSCRIBE SUBSCRIBE SUBSCRIBE SUBSCRIBE SUBSCRIBE SUBSCRIBE SUBSCRIBE SUBSCRIBE
SUBSCRIBE SUBSCRIBE SUBSCRIBE SUBSCRIBE SUBSCRIBE SUBSCRIBE SUBSCRIBE SUBSCRIBE SUBSCRIBE SUBSCRIBE
SUBSCRIBE SUBSCRIBE SUBSCRIBE SUBSCRIBE SUBSCRIBE SUBSCRIBE SUBSCRIBE SUBSCRIBE SUBSCRIBE SUBSCRIBE
SUBSCRIBE SUBSCRIBE SUBSCRIBE SUBSCRIBE SUBSCRIBE SUBSCRIBE SUBSCRIBE SUBSCRIBE SUBSCRIBE SUBSCRIBE
SUBSCRIBE SUBSCRIBE SUBSCRIBE SUBSCRIBE SUBSCRIBE SUBSCRIBE SUBSCRIBE SUBSCRIBE SUBSCRIBE SUBSCRIBE
SUBSCRIBE SUBSCRIBE SUBSCRIBE SUBSCRIBE SUBSCRIBE SUBSCRIBE SUBSCRIBE SUBSCRIBE SUBSCRIBE SUBSCRIBE

SUBSCRIBE TO CHEMICAL ENGINEERING



Written for engineers, by engineers

More and more, business in the Chemical Process Industries (CPI) is not local, it's global. To keep up with this rapidly evolving marketplace, you need a magazine that covers it all, not just one country or region, not just one vertical market, but the whole CPI.

With editorial offices in Europe, Asia, and North America, CHEMICAL ENGINEERING is well-positioned to keep abreast of all the latest innovations in the equipment, technology, materials, and services used by process plants worldwide. **No other publication even comes close.**

**To subscribe, please call 1-847-564-9290
or visit clientservices@che.com**

www.che.com

The #1 choice of worldwide CPI organizations

BUSINESS NEWS

PLANT WATCH

SNC-Lavalin wins contract for sulfuric acid project in Saudi Arabia

February 7, 2014 — SNC-Lavalin Inc. (Montreal, Quebec, Canada; www.snc-lavalin.com), in consortium with Sinopec Engineering Group, has signed a contract with Ma'aden in Saudi Arabia to provide engineering, procurement, construction, commissioning and startup services for a three-line sulfuric acid plant. The total value of the contract is approximately \$764 million. The project is scheduled to be operational in late 2016.

Linde will supply hydrogen at Nynas refinery in Hamburg

February 7, 2014 — The Linde Group (Munich, Germany; www.linde.com) has signed a longterm contract with Nynas AB, for the onsite supply of hydrogen at Nynas' petroleum refinery in Hamburg, Germany. The Linde Engineering Division will build a steam-methane reformer plant with a total investment of approximately €30 million. The new hydrogen facility is scheduled to go onstream in the fourth quarter of 2015 with a capacity of 400,000 m³/d of hydrogen.

Mitsui Chemicals will build plant for xylene diisocyanate in Japan

February 6, 2014 — Mitsui Chemicals (Tokyo; www.mitsuichem.com) is constructing the world's first large-scale plant for xylene diisocyanate (XDI) within its Omuta Works facility in Kyushu, Japan. The plant's capacity will be 5,000 metric tons per year (m.t./yr) and is scheduled for startup in October 2015.

Evonik increases structural foam production with opening of new facility

February 6, 2014 — Evonik Industries AG (Essen, Germany; www.evonik.com) has begun operation at its new production facility for Rohacell polymethacrylimide structural foam in Darmstadt, Germany, following an investment of approximately €6 million. The new facility will increase the polymerization capacity at the site by 50%.

Solvay to increase its natural soda ash production capacity in the U.S.

February 4, 2014 — Solvay S.A. (Brussels, Belgium; www.solvay.com) plans to increase its annual production capacity of natural soda ash at its Green River plant in Wyoming by 150,000 m.t. Construction has already begun to expand production capacity from its current level of around 2 million m.t./yr.

BASF to manufacture chelating agent at new plant in Alabama

January 28, 2014 — BASF SE (Ludwigshafen, Germany; www.basf.com) will build a new plant for its chelating agent Trilon M (methylglycinediacetic acid) at Evonik's Theodore, Ala. site. With an investment of about \$90 million, the new production facility is planned to start up in the second half of 2015.

Asahi Glass to build new refrigerants plant in Japan

January 23, 2014 — Asahi Glass Co., Ltd. (Tokyo; www.agc.com) plans to build a new manufacturing facility using proprietary fluorochemical technology at its Chiba Plant in Japan, and start supplying the new refrigerant HFO-1234yf beginning in mid-2015. The refrigerant will be supplied to Honeywell (Morristown, N.J.; www.honeywell.com) for a previously announced refrigerants facility in Louisiana.

Huntsman expands global capacity for polyetheramines at three sites

January 23, 2014 — The Performance Products Division of Huntsman Corp. (The Woodlands, Tex.; www.huntsman.com) will expand its global capacity for polyetheramines (PEA) by a minimum of 15% after debottlenecking three of its PEA manufacturing plants. With construction currently underway, the company expects the expansion projects at its Conroe, Tex., Llanelli, Wales and Singapore sites to be fully operational by May 2014.

Praxair will construct oxygen-supply facility at steel mill in South Korea

Praxair, Inc. (Danbury, Conn.; www.praxair.com) has signed a longterm contract with Taewoong Steel Co. to supply high-purity oxygen to the company's steel mill facility in the Mieum Foreign Industrial Zone in Busan, South Korea. Praxair will construct a new air-separation plant and pipeline, which are expected to start operations in 2016.

Ineos to license polypropylene technology to new plant in Vietnam

January 22, 2014 — Ineos Technologies (Rolle, Switzerland; www.ineos.com) has licensed its Innovene polypropylene process technology to Vung Ro Petroleum Ltd. at its refinery complex located in Phu Yen Province, Vietnam. The plant will produce various polypropylene grades with a total capacity of 900,000 m.t./yr.

MERGERS AND ACQUISITIONS

Sika acquires Brazilian waterproofing company Lwart Química

February 4, 2014 — Sika AG (Baar, Switzerland; www.sika.com) has agreed to acquire Lwart Química Ltda., a supplier of waterproofing products in Brazil. Last year Lwart Química generated net sales of around \$36.5 million.

Eastman to acquire BP's aviation turbine oil business

January 29, 2014 — Eastman Chemical Co. (Kingsport, Tenn.; www.eastman.com) will acquire the assets of BP's aviation turbine engine oil business. The acquisition includes a production facility in Linden, N.J., laboratory equipment located in Naperville, Ill., and a longterm supply agreement. The acquisition is expected to be completed in the second quarter of 2014.

Balchem and Taminco announce production JV for choline chloride

January 27, 2014 — Taminco Corp. (Allentown, Pa.; www.taminco.com) and Balchem Corp. (New Hampton, N.Y.; www.balchem.com) will form a joint venture (JV) to build and operate a choline-chloride production facility in St. Gabriel, La. The plant is expected to come onstream in 2015.

Arkema acquires acrylic acid plant, forms JV in China

January 23, 2014 — Arkema (Colombes, France; www.arkema.com) and Jurong Chemical have created a JV called Sunke, in which Arkema will have a majority interest, comprising the assets of Jurong's acrylic acid production site in Taixing, China. Production capacity initially will be 160,000 m.t./yr for an investment of \$240 million, with the option to expand to 320,000 m.t./yr for a further investment of \$235 million.

Alpek and United Petrochemical form JV for new plant in Russia

January 17, 2014 — Alpek S.A.B. de C.V. (San Pedro Garza Garcia, Mexico; www.alpek.com) has announced that its subsidiary, Grupo Petrotemex, S.A. de C.V., signed a JV agreement with United Petrochemical Co. for the construction of an integrated purified terephthalic acid (PTA) and polyethylene terephthalate (PET) plant in Ufa, Bashkortostan, Russia. The facility is planned to have a maximum installed capacity of 600,000 m.t./yr each for PTA and PET. ■

Mary Page Bailey

FOR ADDITIONAL NEWS AS IT DEVELOPS, PLEASE VISIT WWW.CHE.COM

March 2014; VOL. 121; NO. 3

Chemical Engineering copyright © 2014 (ISSN 0009-2460) is published monthly by Access Intelligence, LLC, 4 Choke Cherry Road, 2nd Floor, Rockville, MD, 20850. Chemical Engineering Executive, Editorial, Advertising and Publication Offices: 88 Pine Street, 5th Floor, New York, NY 10005; Phone: 212-621-4674, Fax: 212-621-4694. Subscription rates: \$149.97 U.S. and U.S. possessions, \$166.97 Canada, and \$269 International. \$20.00 Back issue & Single copy sales. Periodicals postage paid at Rockville, MD and additional mailing offices. Postmaster: Send address changes to Chemical Engineering, Fulfillment Manager, P.O. Box 3588, Northbrook, IL 60065-3588. Phone: 847-564-9290, Fax: 847-564-9453, email: clientservices@che.com. Change of address, two to eight week notice requested. For information regarding article reprints, please contact Wright's Media, 1-877-652-5295, sales@wrightsmedia.com. Contents may not be reproduced in any form without written permission. Canada Post 40612608. Return undeliverable Canadian Addresses to: IMEX Global Solutions, P.O. BOX 25542, LONDON, ON N6C 6B2

DOWNLOAD THE **CEPCI** TWO WEEKS SOONER AT WWW.CHE.COM/PCI

CHEMICAL ENGINEERING PLANT COST INDEX (CEPCI)

(1957-59 = 100)

CE Index	Dec.'13 Prelim.	Nov.'13 Final	Dec.'12 Final
Equipment	687.9	686.6	693.6
Heat exchangers & tanks	621.6	620.6	634.7
Process machinery	656.0	653.2	657.6
Pipes, valves & fittings	875.7	873.9	895.8
Process instruments	412.6	411.4	415.7
Pumps & compressors	925.8	924.3	899.6
Electrical equipment	513.8	514.1	511.4
Structural supports & misc	746.9	746.3	734.5
Construction labor	318.8	317.8	321.3
Buildings	532.9	532.8	526.8
Engineering & supervision	322.5	323.4	326.9

Annual Index:
2005 = 468.2
2006 = 499.6
2007 = 525.4
2008 = 575.4
2009 = 521.9
2010 = 550.8
2011 = 585.7
2012 = 584.6

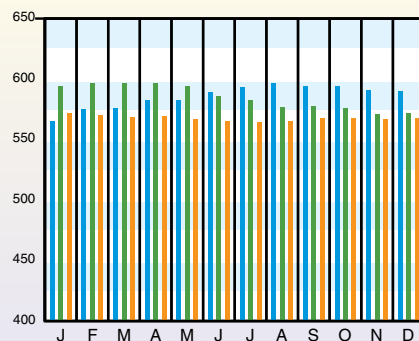

CURRENT BUSINESS INDICATORS*

LATEST

PREVIOUS

YEAR AGO

CPI output index (2007 = 100)	Jan.'14 = 88.8	Dec.'13 = 89.1	Nov.'13 = 88.6	Jan.'13 = 88.3
CPI value of output, \$ billions	Dec.'13 = 2,177.5	Nov.'13 = 2,149.0	Oct.'13 = 2,140.7	Dec.'12 = 2,153.4
CPI operating rate, %	Jan.'14 = 74.8	Dec.'13 = 75.1	Nov.'13 = 74.7	Jan.'13 = 75.0
Producer prices, industrial chemicals (1982 = 100)	Jan.'14 = 294.0	Dec.'13 = 294.2	Nov.'13 = 291.5	Jan.'13 = 305.4
Industrial Production in Manufacturing (2007 = 100)	Jan.'14 = 96.4	Dec.'13 = 97.2	Nov.'13 = 97.0	Jan.'13 = 95.2
Hourly earnings index, chemical & allied products (1992 = 100)	Jan.'14 = 157.7	Dec.'13 = 158.7	Nov.'13 = 157.4	Jan.'13 = 155.0
Productivity index, chemicals & allied products (1992 = 100)	Jan.'14 = 106.7	Dec.'13 = 107.7	Nov.'13 = 106.7	Jan.'13 = 105.6

CPI OUTPUT INDEX (2007 = 100)

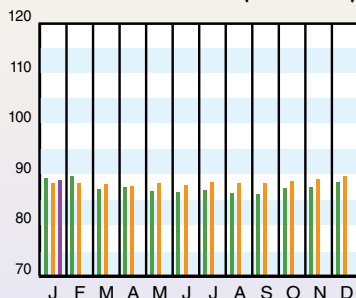

CPI OUTPUT VALUE (\$ BILLIONS)

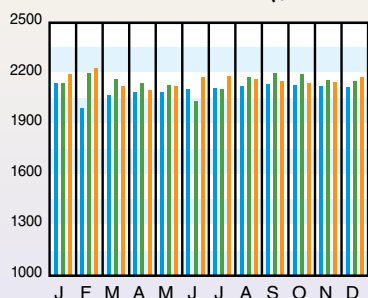

CPI OPERATING RATE (%)

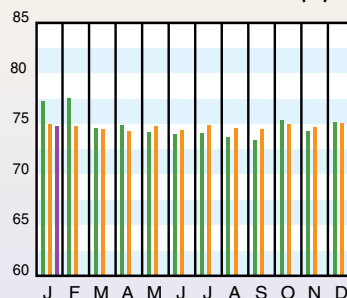

* Current Business Indicators provided by IHS Global Insight, Inc., Lexington, Mass.

HIGHLIGHTS FROM RECENT ACC WEEKLY REPORTS

The first Chemical Activity Barometer (CAB) reading of 2014 showed strengthening, which points to continued growth and an improving U.S. economy throughout 2014, according to the American Chemistry Council (ACC; Washington, D.C.; www.americanchemistry.com). In January, the CAB ticked up to 94.0, increasing 0.2 points over December on a three-month moving average (3MMA) basis. This marks the ninth consecutive monthly gain for the CAB, which is now up 2.6% over a year ago. This growth is at a more moderate pace since the 0.4% gain last seen in September 2013. The CAB is an established leading economic indicator, shown to lead U.S. business cycles by an average of eight months at cycle peaks, and four months at cycle troughs.

Other data recently reported by ACC in their Weekly Chemistry and Economic Reports include U.S. exports of chemicals, which grew 0.4% in 2013, while chemical imports declined by 1.0%. This gain expanded the trade surplus for the U.S. chemical industry to \$3.4 billion. The value of the exports was \$189.1 billion in 2013, while the value of the imports was \$185.7 billion. However, a large deficit exists for the trade of pharmaceuticals. If pharmaceuticals are excluded, the surplus grows to \$41.3 billion. This value is slightly larger than the \$41.2 billion surplus that was observed in 2012, ACC said.

In addition, U.S. specialty chemical market volumes rose 1.0% in December. This follows a 1.1% gain in November and a 0.6% gain in October. Of the 28 specialty chemical segments monitored by ACC, 25 expanded in December. Those segments with large gains (defined at 1.0% or greater) include the following: adhesives and sealants; construction chemicals; electronic chemicals; food additives; foundry chemicals; lubricant additives; mining chemicals; paint additives; and pigments and printing ink. Finally, the U.S. Chemical Production Regional Index rose by 0.8% in December, following a 0.3% gain in November, according to ACC. □

CURRENT TRENDS

Preliminary data for the December 2013 CE Plant Cost Index (CEPCI; top; the most recent available) show a small increase (0.17%) in the overall index compared to the November final index value. The subindices for equipment all rose in December compared to the previous month, except for the electrical equipment index. The current CEPCI value stands at 0.75% lower than the value from a year ago. Meanwhile, updated values for the Current Business Indicators (CBI) from IHS Global Insight (middle) saw the CPI value of output rise in December of last year, while all other CBI values declined slightly in the first month of 2014. Compared to a year ago, five of the indicators are higher, while two are lower. □

Now Available in the *Chemical Engineering* Store:
**Process Water and Wastewater Treatment
and Reuse Guidebook- Volume 2**

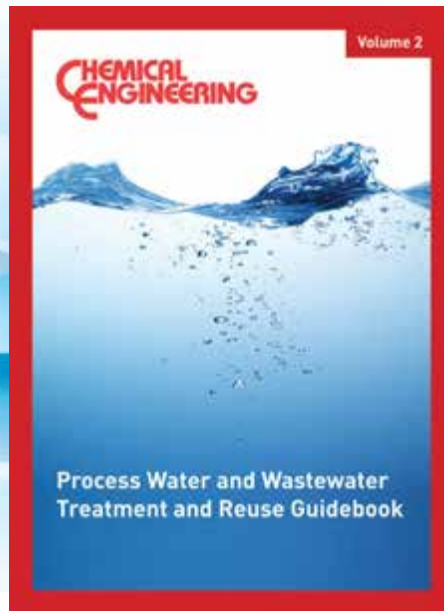

This guidebook contains how-to engineering articles formerly published in *Chemical Engineering*. The articles in Volume 2 provide practical engineering recommendations for process operators faced with the challenge of treating inlet water for process use, and treating industrial wastewater to make it suitable for discharge or reuse.

There is a focus on the importance of closed-loop or zero-discharge plant design, as well as the selection, operation and maintenance of membrane-based treatment systems; treating water for use in recirculated-water cooling systems; managing water treatment to ensure trouble-free steam service; designing stripping columns for water treatment; and more.

Table of Contents

- Process Water Treatment – Challenges and Solutions
- Water Reuse and Conservation in the CPI
- Strategies to Minimize Wastewater Discharge
- Strategies for Water Reuse
- Wastewater: A Reliable Water Resource
- Membranes for Process Water Reuse
- Strategies for Controlling Membrane Fouling
- Fact at Your Fingertips: Membranes
- Facts at Your Fingertips: Membrane Configurations
- Facts at Your Fingertips: Controlling Membrane Fouling
- Biodegradation and Testing of Scale Inhibitors
- Keeping Cooling Water Clean
- Caring for Cooling Water Systems
- Purifying Coke-Cooling Wastewater
- Non-Chemical Water Treatment
- CPI Water and Steam Chemistry
- Designing Steam Stripping Columns for Wastewater

Order your copy today by visiting store.che.com



Another I/O change? Great.
So another wiring schedule.
Another marshalling design.
And another cabinet...
Just make it all go away!

YOU CAN DO THAT



DELTAV™

Electronic marshalling eliminates the rework, the redesign and the headaches.

With DeltaV Electronic Marshalling, Emerson lets you make I/O changes where and when you need them without costly engineering and schedule delays. Our new DeltaV CHARacterization Module (CHARM) completely eliminates the cross-wiring from the marshalling panel to the I/O card—regardless of signal type—so you're no longer held to predefined specifications. All those wires, gone. All that time and engineering, gone. See how easy it can be by scanning the code below or by visiting IOonDemandCalculator.com



The Emerson logo is a trademark and a service mark of Emerson Electric Co. © 2012 Emerson Electric Co.



EMERSON™
Process Management

EMERSON. CONSIDER IT SOLVED.™