

*Test Your  
Vocabulary 4*

*Test Your Vocabulary* is the best-selling series of vocabulary practice books by Peter Watcyn-Jones. They are ideal for use in the classroom or for self-study. Special features include:

- approximately 6,400 new words and phrases to learn and use in the series, from Beginner to Advanced
- vocabulary practised and revised from level to level
- a wide variety of test-types including gap-filling, multiple-choice, crosswords, puzzles, correcting misprints and picture tests
- an Introduction with notes on how to use the tests
- a complete Answer Key.

This new edition of *Test Your Vocabulary 4* is for everyone studying for the Cambridge Certificate of Advanced English and Proficiency examinations. There are tests on such specialized areas as sounds, moods and feelings, and the skeleton, plus phrasal verbs, idioms, slang and colloquial expressions. *Test Your Vocabulary 4* contains 58 tests.

Cover photograph © Photonica S.O.A.

START TESTING YOUR VOCABULARY	BEGINNER / ELEMENTARY	850 WORDS
TEST YOUR VOCABULARY 1	ELEMENTARY / LOWER INTERMEDIATE	900 WORDS
TEST YOUR VOCABULARY 2	INTERMEDIATE	1000 WORDS
TEST YOUR VOCABULARY 3	INTERMEDIATE / FCE	950 WORDS
TEST YOUR VOCABULARY 4	UPPER INTERMEDIATE / CAE	1000 WORDS
TEST YOUR VOCABULARY 5	ADVANCED / CPE	1700 WORDS



PENGUIN

Published and distributed by  
Pearson Education Limited

*Test Your*



*Vocabulary*



4

PETER WATCYN-JONES

**Test  
Your  
Vocabulary –  
Book 4**

**Peter Watcyn-Jones**

**Illustrated by Sven Nordqvist**

Pearson Education Limited  
 Edinburgh Gate, Harlow,  
 Essex CM20 2JE, England  
 and Associated Companies throughout the world.

First published by Penguin Books 1988  
 This edition published 2000  
 Second impression 2000

Text copyright © Peter Watcyn-Jones 1983  
 Illustrations copyright © Sven Nordqvist 1983  
 All rights reserved

Printed in England by Clays Ltd, St Ives plc  
 Set in Times

Except in the United States of America, this book is sold subject to the condition that it shall not, by way of trade or otherwise, be lent, re-sold, hired out, or otherwise circulated without the publisher's prior consent in any form of binding or cover other than that in which it is published and without a similar condition including this condition being imposed on the subsequent purchaser

Published by Pearson Education Limited in association with Penguin Books Ltd., both companies being subsidiaries of Pearson Plc

## CONTENTS

Introduction	v	Test 30 Objects and things in the home 2	40
To the student	v	31 Prepositional phrases 2	41
Test 1 The animal kingdom	1	32 Colloquial expressions 2	42
2 Missing words – travel, etc.	2	33 Sounds	44
3 Choose the word 1	3	34 Which word is the same?	45
4 Phrasal verbs 1	6	35 Fastenings/fasteners	46
5 Definitions – types of people	8	36 What is it part of?	47
6 The skeleton	9	37 Health words	48
7 Word association	10	38 What are the questions?	50
8 Missing words – nature, etc.	11	39 Idioms of comparison	52
9 Word building 1	12	40 Make or do	54
10 Synonyms and opposites		41 Jobs	55
crossword – adjectives	14	42 Cartoons	56
11 Missing words – ways of looking	15	43 Bits and pieces	58
12 Collective nouns	16	44 Synonyms and opposites	
13 Objects and things in the home	17	crossword – various words	60
14 Colloquial expressions 1	18	45 Missing words – ‘a breath of’, etc.	62
15 Prepositional phrases 1	20	46 Newspaper misprints	64
16 Who’s the boss?	21	47 Colloquial expressions 3	66
17 Words associated with numbers	22	48 Words to describe (temporary)	
18 Confusing words	23	moods, states and feelings	68
19 Choose the word 2	25	49 Words beginning with ‘de’	70
20 Missing words – ‘he said’, etc.	27	50 Right or wrong?	71
21 Phrasal verbs 2	28	51 Who wrote what?	72
22 Puzzle it out – who won the		52 Group the words	73
2.15 race?	30	53 Find the rhyming word	74
23 Add two letters	31	54 One word, two meanings	75
24 Crime and punishment	32	55 Choose the word 3	76
25 Crossword – things in the home	34	56 Verb + noun combinations	77
26 Classifications	36	57 Fill in the missing letters	78
27 From shore to crash	37	58 ‘Daft’ definitions	79
28 British and American English	38	Answers	80
29 Missing words – ‘he walked’, etc.	39		

## TITLES IN THE SERIES

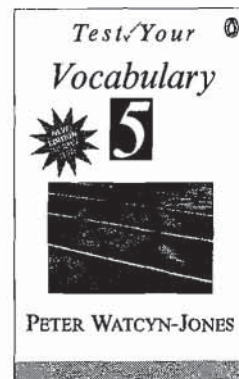
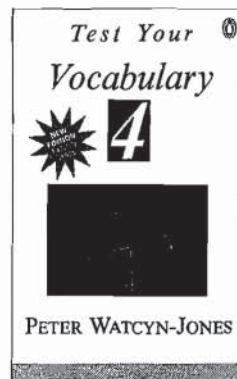
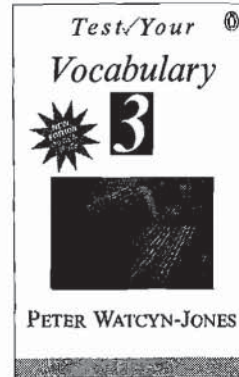
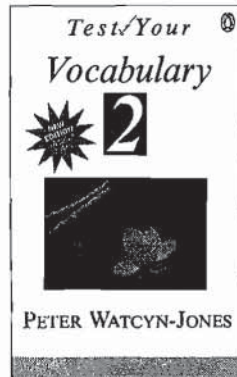
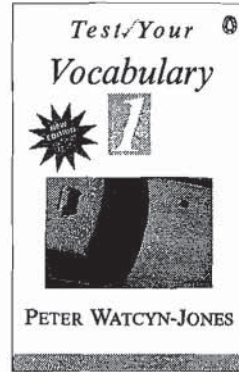
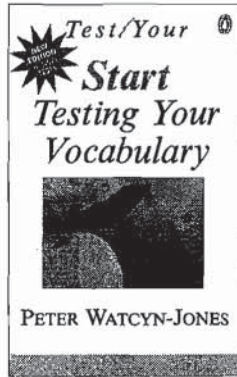

## INTRODUCTION

Nowadays few people will dispute the importance of vocabulary, especially the need for active vocabulary practice. The *Test Your Vocabulary* books filled this need when they first came out, and they continue to do so. There are six books in the series, from elementary to advanced level. In this new edition of the series each book has ten new tests. To facilitate self-study there is a full Answer Key. Students using *Test Your Vocabulary* will find learning vocabulary both stimulating and enjoyable.

*Test Your Vocabulary 4* is the fifth book in the series and is intended for upper intermediate students, especially those studying for the Cambridge Certificate of Advanced English and Cambridge Proficiency examinations. There are fifty-eight tests, and approximately 1,000 words in the book. There are tests on word-building, phrasal verbs and idioms. In addition, there are tests based on different ways of saying the same thing, slang, synonyms, antonyms, prepositional phrases, health words, rhyming words, verb-noun collocations, and words with more than one meaning.

## TO THE STUDENT

This book will help you to learn a lot of new English words. But in order for the new words to become 'fixed' in your mind, you need to test yourself again and again. Here is one method you can use to help you learn the words.

- 1 Read through the instructions carefully for the test you are going to try. Then try the test, writing your answers in pencil.
- 2 When you have finished, check your answers and correct any mistakes you have made. Read through the test again, paying special attention to the words you didn't know or got wrong.
- 3 Try the test again five minutes later. You can do this either by covering up the words (for example, in the picture tests) or by asking a friend to test you. Repeat this until you can remember all the words.
- 4 Rub out your answers.
- 5 Try the test again the following day. (You should remember most of the words.)
- 6 Finally, plan to try the test at least twice again within the following month. After this most of the words will be 'fixed' in your mind.



# 1 The animal kingdom

Write the number of each drawing next to the correct word.

bat	.....
donkey	.....
octopus	.....
wolf	.....
elk	.....
fox	.....
rhinoceros	.....
hedgehog	.....
reindeer	.....
hippopotamus	.....
squirrel	.....
tortoise	.....

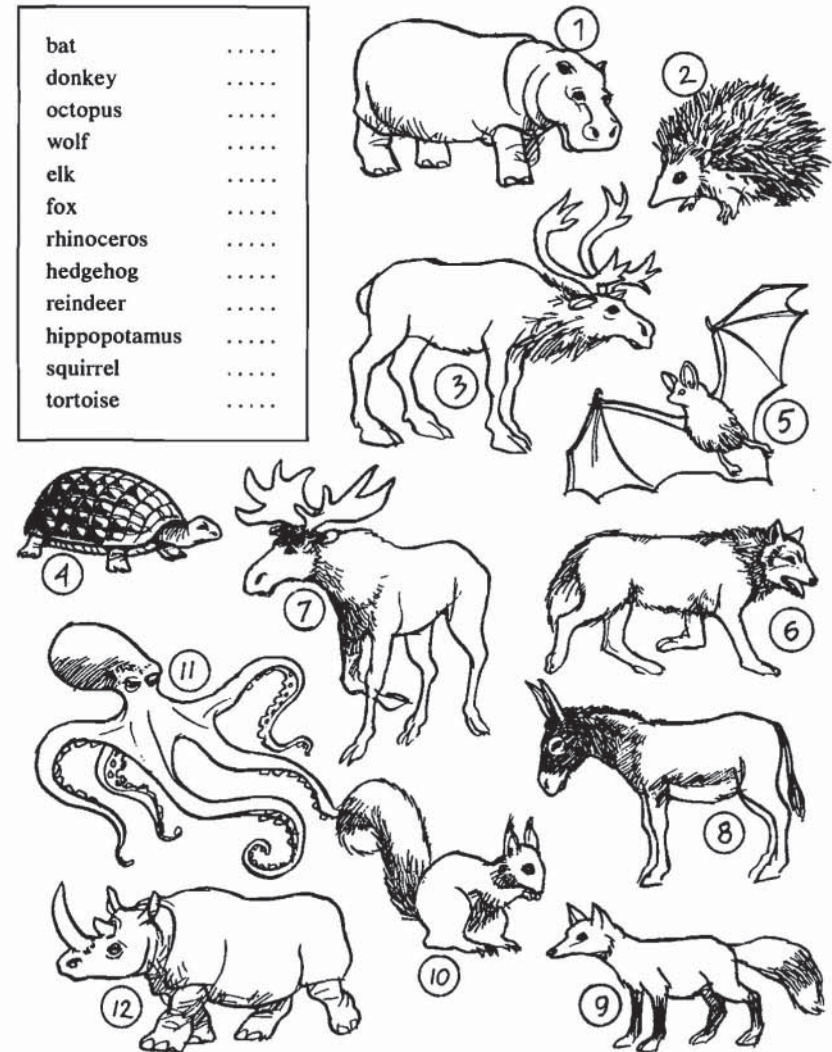

## 2 Missing words – travel, etc.

Put the following words into the correct sentences. Use each word once only.

flight	travel	run
journey	voyage	cruise
trip	outing	package tour
excursion	tour	expedition

- We visited lots of famous towns on our American ..... last year.
- Before the invention of the aeroplane, the ..... from Britain to America could take weeks, even months sometimes.
- Do you want to come for a ..... in my new car on Sunday?
- The plane now arriving is ..... SAS 343 from Copenhagen.
- The first thing I did when I got to London was to go on a sightseeing .....
- In my opinion, the best way to ..... is by air.
- Last summer I stayed in Brighton and one day our group went on a very interesting ..... to Blenheim Palace, the home of the late Winston Churchill.
- My uncle is going on an ..... next year to try to discover the lost city of Atlantis.
- How long does the train ..... from London to Edinburgh take?
- Last year my mother went on a Mediterranean ..... and was seasick practically the whole time.
- One of the main advantages of going on a ....., apart from the price, is the fact that you don't have to spend weeks beforehand planning routes, finding hotels, buying air tickets, etc. It's all done for you.
- We went on a day's ..... to the zoo in Copenhagen and the whole family loved it.

## 3 Choose the word 1

Choose the word which best completes each sentence.

- He used to observe the stars from his attic through the .....  
 a roof window    b cupola    c skylight    d French windows  
 e attic window
- Excuse me, John, do you think I could ..... your phone?  
 a use    b lend    c borrow    d take  
 e loan
- I'm sorry, David. It wasn't my ..... to cause a quarrel between you and Joanna.  
 a meaning    b point    c intention    d view  
 e reason
- Although someone had seen him take the watch, he still ..... it.  
 a refused    b rejected    c disowned    d denied  
 e hid
- The inside of an apple is called the .....  
 a pip    b core    c stone    d peel  
 e kernel
- A woman who has never married is called a .....  
 a virgin    b widower    c bachelor    d spinster  
 e widow
- In England, it is easy to drive at night because of the ..... along the middle of the road.  
 a cat's eyes    b lines    c signposts    d indicators  
 e warning lights
- The ..... between the rich and poor countries of the world is increasing daily.  
 a space    b gap    c distance    d interval  
 e opening

- 9 Before every Board Meeting, it is customary for the ..... of the previous meeting to be read out.  
a protocol      b notes      c précis      d minutes  
e points
- 10 On first coming to England, I fell ..... in love with a girl who lived in the flat below mine.  
a feet over hands      b hole over hole      c foot in mouth      d elbow to toe  
e head over heels
- 11 A cat licks its ..... before it washes its face.  
a paw      b hoof      c tail      d claws  
e fur
- 12 I'm afraid I haven't the ..... idea why he never turned up.  
a least      b faintest      c weakest      d fainted  
e simplest
- 13 I badly ..... my ankle when I fell on my way home last night.  
a stretched      b sprained      c strained      d pulled  
e caught
- 14 People are ..... to wear reflectors on their clothing when walking along a road in the dark.  
a told      b warned      c advised      d suggested  
e informed
- 15 I'm not surprised he became an author. Even as a child he had a ..... imagination.  
a large      b great      c vivid      d bright  
e clean
- 16 The TV announcer apologized for the breakdown and said that normal service would be ..... as soon as possible.  
a resumed      b returned      c continuous      d repeated  
e recovered
- 17 I hate ..... oranges. I usually get my wife to do it for me since she has long nails.  
a skinning      b slicing      c peeling      d shaving  
e cutting

- 18 My mother was ..... ill last summer but, fortunately, is now making a slow but steady recovery  
a critically      b deeply      c fatally      d definitely  
e serious
- 19 You haven't seen my knitting ..... anywhere, have you? I can't seem to find them.  
a pins      b nails      c rods      d sticks  
e needles
- 20 Mr and Mrs Grove were very ..... when their dog died.  
a anxious      b upset      c confused      d disappointed  
e discouraged

# 4 Phrasal verbs 1

Replace the words in brackets in the following sentences with a suitable phrasal verb. (Make any other necessary changes).

call on	get down	cut up
get on for	go off	take off
do in	look in	go down with
turn down	take to	go out
go down	get at	give away
look up	go back to	take away

- If he says that again I'll ..... him ..... — I swear it!  
(kill him)
- You'd better not drink that milk, Joe. It's .....  
(turned sour)
- We knew he wasn't English as his accent ..... him .....  
(betrayed him)
- The house I live in ..... the 15th century.  
(dates from)
- Let's ..... Paul and Jan tonight. It's been ages since  
we last saw them.  
(go and visit)
- Clive was really ..... when he failed his proficiency  
exam.  
(upset)
- I think I'll go somewhere for the weekend. Things have been .....  
me ..... lately, so a change of air will do me good.  
(making me depressed)
- John can't come with us tonight after all. It seems he's .....  
a cold.  
(caught)
- "What does 'misogynist' mean, Allan?"  
"I've no idea, Jill. You'd better ..... it ..... in the diction-  
ary.  
(find out its meaning)
- The power point was behind the piano, which made it very difficult to  
.....  
(reach)
- You're not going to wear a mini-skirt are you, Jane? They  
..... years ago.  
(stopped being fashionable)
- "How old is Eva?"  
"I'm not sure, but she must be ..... forty."  
(nearly)
- If you ..... 25 from 100, you're left with 75.  
(subtract)
- No one really believed it when the news came through that the "Titanic" had  
..... on her maiden voyage.  
(sunk)
- I tried smoking a pipe once, but I never really ..... it.  
(liked)
- I was offered a job in Leeds but I ..... it ..... because I  
didn't want to move away from Hastings.  
(refused it)
- I can't stop now but I'll ..... later on my way home  
from work.  
(pay a short visit)
- You should see Brian ..... the new boss. The way he  
does it is really fantastic. He's just like him!  
(imitate)



# 5 Definitions – types of people

Fill in the missing words in the definitions below. Choose from the following:

chauvinistic	versatile	gullible
illiterate	magnanimous	vivacious
bilingual	indefatigable	convivial
erudite	scintillating	greedy

- 1 A/an ..... person is someone who has a variety of skills and abilities and who is able to change easily from one sort of activity to another.
- 2 A/an ..... person is someone who is very friendly and fond of eating, drinking and good company.
- 3 A/an ..... person is someone who is very generous towards other people.
- 4 A/an ..... person is someone who always wants more than his or her fair share of something—especially food, money or power.
- 5 A/an ..... person is someone who is easily taken in or tricked by others.
- 6 A/an ..... person is someone who believes that the sex he or she belongs to (male or female) is better than the opposite sex in all ways.
- 7 A/an ..... person is someone who is unable to read or write.
- 8 A/an ..... person is someone who is fluent in two languages.
- 9 A/an ..... person is someone who seems to have so much energy that he or she never tires.
- 10 A/an ..... person is someone who has studied a lot and is very knowledgeable.
- 11 A/an ..... person is someone who is able to make clever, witty and entertaining remarks or conversation.
- 12 A/an ..... person is someone (usually a woman) who is full of life.

# 6 The skeleton

Write the numbers 1–12 next to the correct word or words.

thigh bone	.....
collarbone	.....
kneecap	.....
skull	.....
shin bone (tibia)	.....
wrist bones	.....
breastbone	.....
spine/backbone	.....
shoulder blade	.....
hipbone	.....
fibula	.....
rib	.....

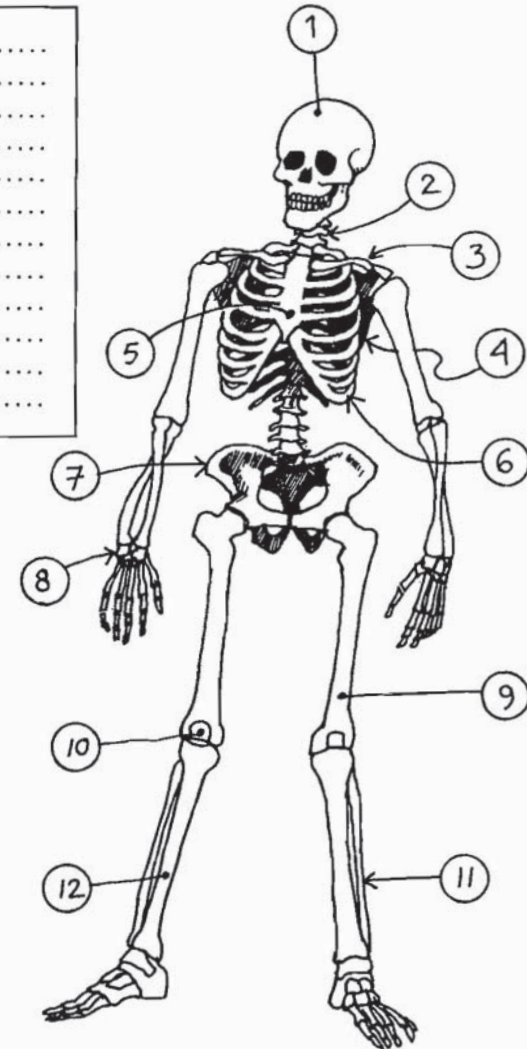

# 7 Word association

The following groups of four words are all connected with the same thing. Write down the missing word in each group. Before starting, look at the example.

Example: bark, trunk, leaf, branch TREE

- 1 cell, warder, sentence, bars
- 2 key, hammer, grand, pedal
- 3 column, circulation, tabloid, article
- 4 springs, head, foot, sheet
- 5 green, hole, swing, club
- 6 hood, hub cap, bonnet, wing
- 7 zodiac, moon, Mars, Sagittarius
- 8 corner, ring, second, bout
- 9 hand, strap, wind, time
- 10 tile, gutter, chimney, skylight
- 11 paw, fur, whiskers, claws
- 12 lens, shutter, speed, flash
- 13 circle, stalls, auditorium, box office
- 14 wing, tail, undercarriage, fly
- 15 frame, pane, catch, glass
- 16 coffin, wreath, cemetery, corpse
- 17 pawn, castle, bishop, queen
- 18 moat, battlements, keep, dungeon
- 19 scrum, try, All Blacks, line-out
- 20 cowshed, pen, barn, harvest



# 8 Missing words – nature, etc.

Put the following words into the correct sentences. Use each word once only.

countryside	country	setting
nature	bush	scene
landscape	scenery	rural
view	highlands	environment

- 1 Many people choose Switzerland for their holidays because of its beautiful .....
- 2 Turner was one of England's most famous ..... painters.
- 3 They stood gazing at the happy ..... of children playing in the park.
- 4 If I had to choose, I would much prefer to live in the ..... than in a town.
- 5 One of the most beautiful and unspoilt areas of Britain are the ..... of Scotland.
- 6 The main difference between the English and French ..... is that in England most fields and meadows are bordered by hedges, giving the impression from a distance of a large patchwork quilt.
- 7 Children living in ..... areas often have to travel miles to school every day.
- 8 One of the most frightening examples of the force of ..... is seen during a tornado.
- 9 In Australia, the name given to the wild, uncleared area of the country is the .....
- 10 The house, standing alone in the middle of the marsh, was the perfect ..... for a horror film.
- 11 Many people are very concerned with the way Man has destroyed and continues to destroy the .....
- 12 Although I liked the appearance of the house, what really made me decide to buy it was the fantastic ..... through the window.

# 9 Word building 1

The word in capitals at the end of each of the following sentences can be used to form a word that fits suitably in the blank space. Fill each blank in this way.

Example: You can always rely on Barbara. She is very  
DEPENDABLE

- |  |          |
|--|----------|
| 1 He was born blind; but despite this .....<br>he still managed to become one of the top Pop singers of<br>his generation. | DEPEND   |
| 2 ..... I'm in favour of the plan, but<br>there are still one or two points that I'm not entirely happy<br>with.           | ABLE     |
| 3 What a lovely painting! Your daughter must be very<br>....., Mrs Green.  | BASE     |
| 4 I think it's very ..... of him to<br>expect us to work overtime every night this week.                                   | ART      |
| 5 There is a saying in English: ".....<br>speak louder than words."  | REASON   |
| 6 That rule is not ..... in this case.   | ACT      |
| 7 I don't think Tom's been getting too much sleep lately. His<br>eyes are terribly .....                                   | APPLY    |
| 8 English is a ..... easy language for<br>Swedes to learn.   | BLOOD    |
| 9 Now, don't tell anyone else what I've just told you. Re-<br>member, it's .....   | COMPARE  |
| 10 I don't think their marriage will last long. They're<br>..... quarrelling.  | CONFIDE  |
| 11 The teacher punished the child for .....  | CONTINUE |
| 12 Librarians spend a lot of their time .....<br>books.  | OBEY     |
| 13 I don't care if you'd had too much to drink. Your be-<br>haviour last night was quite .....                             | CLASS    |
|  | DEFEND   |

- |  |         |
|--|---------|
| 14 If you think I'm going to marry you, then I'm afraid you're<br>very much .....  | TAKE    |
| 15 The man was found guilty of fraud and sentenced to three<br>years .....   | PRISON  |
| 16 Despite the star-studded cast, the film was only .....<br>..... successful.   | PART    |
| 17 He won the discus event at the Olympic Games but was<br>later ..... when a medical check<br>proved that he had been taking drugs. | QUALIFY |
| 18 The recent hurricane caused .....<br>damage.  | WIDE    |
| 19 Industrial robots work with far greater .....<br>than most men.   | PRECISE |
| 20 I've tried to advise my daughter against hitch-hiking<br>around Europe alone, but she won't listen to me. She's so<br>.....       | HEAD    |



# 10 Synonyms and opposites crossword – adjectives

Read through the sentences below and fill in the crossword.

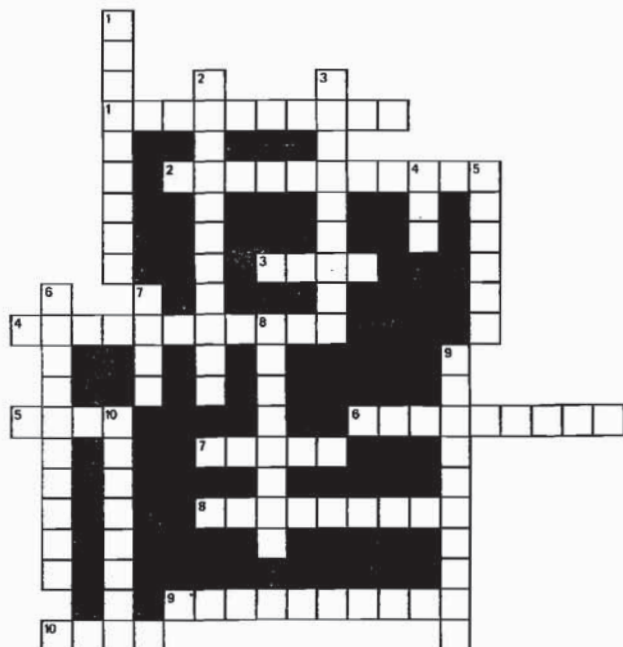

### ACROSS

- 1 Synonym for unbelievable
- 2 Synonym for hard-working
- 3 Opposite of generous
- 4 Synonym for thoughtful
- 5 Synonym for impolite
- 6 Opposite of permanent
- 7 Opposite of sharp
- 8 Opposite of modest
- 9 Opposite of deliberate
- 10 Synonym for enormous

### DOWN

- 1 Synonym for annoyed
- 2 Opposite of opaque
- 3 Synonym for stubborn
- 4 Synonym for peculiar
- 5 Opposite of plentiful
- 6 Opposite of voluntary
- 7 Opposite of gigantic
- 8 Synonym for wealthy
- 9 Synonym for reliable
- 10 Synonym for thrilling

# 11 Missing words – ways of looking

Put the following words into the correct sentences. Use each word once only and make any necessary changes.

distinguish	recognise	gaze	eye
scrutinise	watch	notice	catch a glimpse of
glance	stare	catch someone's eye	glare
peer	peep	observe	look at

- 1 He had changed so much since I last saw him that I hardly ..... him.
- 2 The young girl ..... lovingly at the photograph of her boyfriend.
- 3 I only ..... him, so I can't really remember whether he was wearing a hat or not.
- 4 As my brother is colour-blind, he finds it difficult to ..... between green and blue.
- 5 "..... the board, please!" said the teacher.
- 6 She ..... out of the window for a moment, then carried on working.
- 7 The old man ..... through the closed curtains at his new neighbours.
- 8 The teacher ..... angrily at the class. "For the last time, who broke the window?" she roared.
- 9 He ..... the figures very carefully before making any comment.
- 10 In Britain it is considered rude to ..... at people.
- 11 The policeman ..... the young man suspiciously.
- 12 He ..... through the thick fog, trying to make out the number of the approaching bus.
- 13 I waved to attract her attention, but she walked away without ..... me.
- 14 Are you going to ..... the film on TV tonight?
- 15 I wanted to order coffee, but the waiter was so busy that it was very difficult to .....
- 16 When I was a student, I used to spend a lot of time sitting in cafés, ..... the way people used their hands when they spoke to one another.



# 12 Collective nouns

Fill in the missing words.

- 1 A ..... of actors
- 2 A ..... of Indians
- 3 A ..... of directors
- 4 A ..... of furniture
- 5 A ..... of birds
- 6 A ..... of grapes
- 7 A ..... of puppies
- 8 A ..... of football players
- 9 A ..... of teachers
- 10 A ..... of people
- 11 A ..... of cattle
- 12 A ..... of bees
- 13 A ..... of golf clubs
- 14 A ..... of sailors
- 15 A ..... of wolves
- 16 A ..... of fish
- 17 A ..... of ships
- 18 A ..... of armour
- 19 A ..... of rags
- 20 A ..... of steps

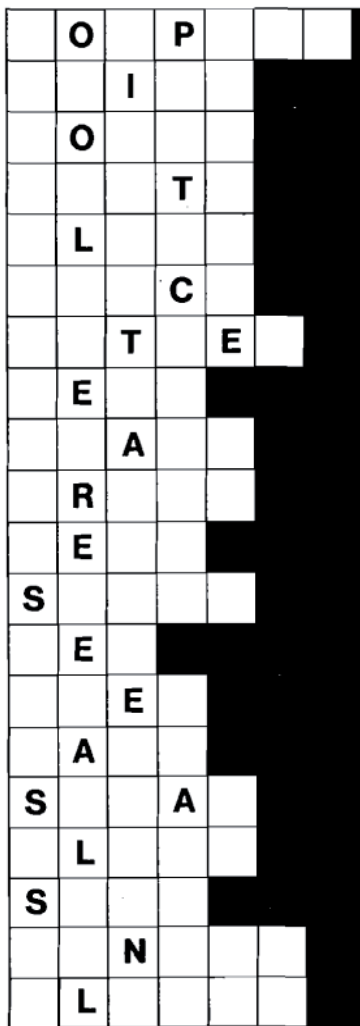

# 13 Objects and things in the home

Write the number of each of the following drawings next to the correct word.

- |                |       |
|----------------|-------|
| nut            | ..... |
| butter-dish    | ..... |
| coal scuttle   | ..... |
| sieve          | ..... |
| box of tissues | ..... |
| bolt           | ..... |
| rubbish-bin    | ..... |
| washer         | ..... |
| table-mat      | ..... |
| chopper        | ..... |
| draining-board | ..... |
| mantelpiece    | ..... |

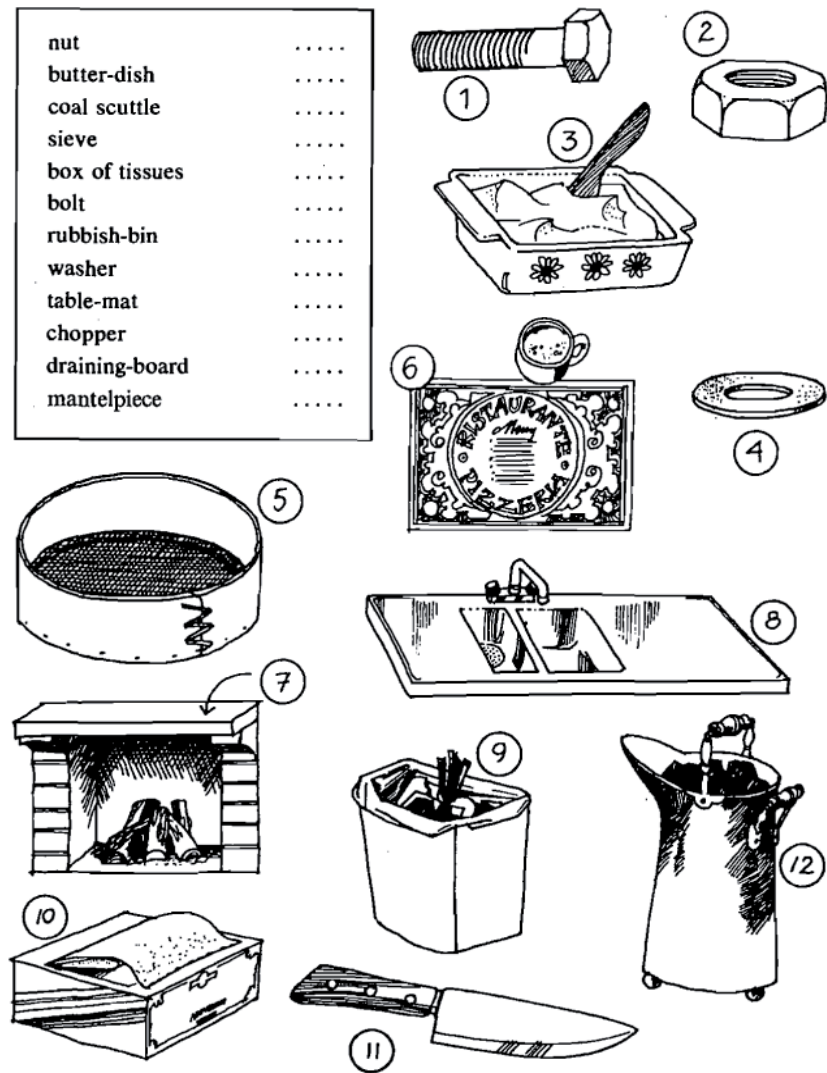

# 14 Colloquial expressions 1

Replace the words in brackets in the following sentences with a suitable colloquial expression from the list below.

dead beat	flogging a dead horse	make ends meet
was a bit out of sorts	at loggerheads	got into hot water
gave me the cold shoulder	get a move on	it sticks out a mile
cats and dogs	black and blue all over	hit the roof
hard up	few and far between	stuck up

- 1 I'm not going to play football again. I was .....  
(covered with bruises)  
..... after the match last Saturday.
- 2 I wish I hadn't taken that day off without asking for permission. I really .....  
..... when Mr Bradshaw found out.  
(got into trouble)
- 3 I always seem to be ..... these days. I can't  
(short of money)  
even afford to go to the pub at weekends.
- 4 Charles and his wife are always ..... I really  
(quarrelling)  
don't know why they got married in the first place.
- 5 I do wish our teacher wouldn't keep telling Jane how good she is. She's getting far  
too ..... for words!  
(conceited)
- 6 After running 20 kilometres yesterday afternoon I was absolutely .....  
(exhausted)  
.....
- 7 What's wrong with Sue? I said hello to her but she .....  
(completely ignored me)  
.....

- 8 What with rising prices and everything, I'm surprised that anyone can .....  
..... nowadays.  
(manage financially)
- 9 My son ..... today,  
(wasn't feeling very well)  
so I decided to keep him home from school.
- 10 You're ..... trying to  
(wasting your time)  
persuade Charles to come with us. You know he won't go anywhere without his  
wife.
- 11 Jill's father ..... when she told him that she  
(became very angry)  
had lost his car keys.
- 12 My visits to my parents nowadays are, unfortunately, very .....  
(infrequent)  
.....
- 13 Look, if we don't ....., we're going to miss the  
(hurry)  
last bus!
- 14 Could you lend me an umbrella, Sally? It's raining .....  
(heavily)  
at the moment.
- 15 Of course Peter's in love with Joanna. ....  
(It's so obvious)

# 15 Prepositional phrases 1

Fill in the missing prepositions in the following sentences.

- 1 Giant pandas rarely breed ..... *captivity*.
- 2 My car's not worth much—..... *most* £50.
- 3 English people ..... *general* are very friendly. .... *least* that's what I've heard.
- 4 Don't ask Rose to join the choir. She sings ..... *tune* all the time.
- 5 I don't know why they got married. They have absolutely nothing ..... *common*.
- 6 Most Englishmen earn ..... *average* about £110 a week.
- 7 Oh, what's the word? I know it! *It's* ..... *the tip* ..... *my tongue!*
- 8 Don't forget that you can always come to me if you're ever ..... *trouble*.
- 9 He died ..... *the age* ..... *eighty-five*.
- 10 Thank you for coming, Mr Baker. We'll be contacting you ..... *due course* about our decision.
- 11 It's my own fault, I suppose. I took him ..... *his word* when he said he wouldn't try to run away.
- 12 The young, inexperienced teacher tried ..... *vain* to control her noisy class.
- 13 I'll overlook it this time, but please try to be more polite ..... *future*.
- 14 To pay 60 % income-tax is ..... *no means* unusual in Sweden.
- 15 My sister plays the piano ..... *ear*.
- 16 The rent is to be paid ..... *advance*.
- 17 He sent the documents to the bank ..... *safe keeping*.
- 18 His name is Nicholas—Nick ..... *short*.
- 19 This book is ..... *far* the best one he's ever written.
- 20 Work on the new motorway is already ..... *progress*.

# 16 Who's the boss?

Choose from the words on the right the name of the person who is in charge of or the leading person in the group, place, etc. on the left. Look at the example first.

- |  |                      |                             |
|--|----------------------|-----------------------------|
| 1 The British Army                     | <u>FIELD MARSHAL</u> |                             |
| 2 The United Nations                   | .....                | captain                     |
| 3 A TV programme                       | .....                | chairperson                 |
| 4 A group of workers                   | .....                | leader                      |
| 5 A shop                               | .....                | matron                      |
| 6 A primary school                     | .....                | chief/chieftain             |
| 7 A monastery                          | .....                | governor                    |
| 8 A football team                      | .....                | Managing Director           |
| 9 A museum                             | .....                | choirleader                 |
| 10 A prison                            | .....                | Principal                   |
| 11 Servants (in a household)           | .....                | foreman                     |
| 12 A college                           | .....                | umpire                      |
| 13 A committee                         | .....                | President                   |
| 14 A university                        | .....                | headmaster/<br>headmistress |
| 15 A tennis match                      | .....                | manager                     |
| 16 The governing party<br>(in Britain) | .....                | butler                      |
| 17 A tribe                             | .....                | Mother Superior             |
| 18 A company                           | .....                | Field Marshal               |
| 19 A convent                           | .....                | curator                     |
| 20 An orchestra                        | .....                | warden                      |
| 21 An Old People's Home                | .....                | editor                      |
| 22 A choir                             | .....                | producer                    |
| 23 A Republic                          | .....                | Vice-Chancellor             |
| 24 A newspaper or magazine             | .....                | abbot                       |
| 25 A hospital                          | .....                | Secretary-General           |
|  |                      | Prime Minister              |

# 17 Words associated with numbers

Read through the following sentences and fill in the missing words.

- 1 In this mathematical system,  $101 = 5$ .
- 2 A 3-wheeled cycle.
- 3 A period of a hundred years.
- 4 One person who sings.
- 5 A person who has two wives.
- 6 Two people singing together.
- 7 A five-sided figure.
- 8 A period of ten years.
- 9 An aeroplane with two sets of wings.
- 10 A period of two weeks.
- 11 A combat between two people.
- 12 A dramatic performance or speech for a single actor.
- 13 A person who can use both hands equally well.
- 14 Two babies born at the same time.
- 15 An insect which is said to have a hundred feet.
- 16 An instrument with two lenses which helps bring distant objects closer.
- 17 A mythological animal with a horn in the middle of its head.
- 18 Four musicians playing together.
- 19 Government by two or more parties.
- 20 Three babies born at the same time.

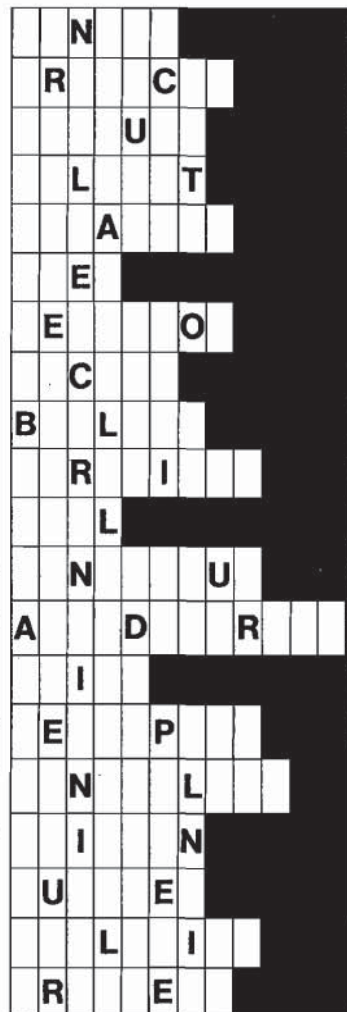

# 18 Confusing words

Choose the correct word in each of the following sentences.

- 1 Although she was (crippled/lame) and thus confined to a wheelchair, she still managed to cope with a family and most of the housework.
- 2 The dress doesn't fit. I'll have to have it (changed/alterd).
- 3 If people must smoke in bed, then they should at least take the precaution of buying (non-flammable/inflammable) sheets and blankets.
- 4 Although my father has (deficient/defective) hearing, he still refuses to wear a hearing-aid.
- 5 The baby (blinked/winked) when its mother clapped her hands in front of its face.
- 6 Of all the writers of (comic/comical) opera, Gilbert and Sullivan are my favourites.
- 7 Where were you (educated/trained) to be a teacher?
- 8 My brother is studying to be an (electrical/electric) engineer.
- 9 I do wish you'd grow up, John! You're so (childish/childlike) at times.
- 10 There's a (rumour/reputation) going round the office that Mr Burgess and Miss Gibson are getting engaged.
- 11 I wonder if you would like to (co-operate/collaborate) with me on a book I'm thinking of writing about famous women in politics?
- 12 There is a very good (Technological/Technical) College not far from where I live.
- 13 Did you know that Peter had arranged the party (specially/especially) for you?
- 14 I couldn't care less one way or the other. I'm completely (uninterested/disinterested).
- 15 I hear that Manchester United beat Liverpool two—(nil/nought) in last night's Cup match.
- 16 There is a very strong (possibility/opportunity) that man will land on the planet Mars before the year 2000.
- 17 South Wales was once a flourishing coal-mining area, but today there are hundreds of (misused/disused) coalmines scattered throughout the valleys.
- 18 My uncle has just got a divorce, which is very strange since he is a marriage guidance (councillor/counsellor).
- 19 I'm afraid the boot is full. There is no (room/space) for any more suitcases.
- 20 It's much too hot. Let's go and sit in the (shadow/shade) for a while.
- 21 I'll see you next week—(eventually/possibly) on Friday.



- 22 The tennis match was held up for ten minutes when the (umpire/referee) fainted.
- 23 Any idea what the present Government's (politics/policy) is on defence?
- 24 They climbed up the steep stone (stairs/steps) leading to the old church.
- 25 I hope he has got a good (solicitor/barrister) to represent him in court. Robbing a bank is a pretty serious offence.
- 26 What did you think of the (critic/write-up) we got in the paper this morning?
- 27 His (financial/economic) worries were solved when he suddenly won £250,000 on the Football Pools.
- 28 During the last war, Vera Lynn's songs contributed greatly to the (morals/morale) of the troops.
- 29 My new flat is just around the corner from my office, which is very (convenient/comfortable) for me.
- 30 The house I have just bought is in a very good residential area, close to shops, schools and other local (amenities/facilities).

## 19 Choose the word 2

Choose the word which best completes each sentence.

- 1 I'm afraid I really couldn't eat any more. I'm .....  
a full up    b fed up    c filled up    d famished    e satisfactory
- 2 It's a ..... of time talking to James. He never listens.  
a lot    b loss    c slash    d waste    e model
- 3 Which ..... of cigarettes do you usually smoke, Ulla?  
a make    b sort    c mark    d brand    e shortage
- 4 He was found guilty of having lied when giving evidence in court and, as a result, was sentenced to two years imprisonment for .....  
a fraud    b a liar    c perjury    d deception    e lying
- 5 Don't tell Allan about John and Mary. You know he can't ..... a secret.  
a hold    b keep    c save    d stop    e prevent
- 6 May I borrow your pen, Jane? I seem to have ..... mine at home.  
a left    b forgotten    c lost    d kept    e missed
- 7 Last year ABBA made a ..... of several million crowns.  
a win    b gain    c profit    d salary    e rise
- 8 Even though I didn't want my son to leave home, since he was twenty-one there was nothing I could do to ..... it.  
a hinder    b prevent    c resist    d end    e cease
- 9 A/an ..... five thousand people are believed to have died in the recent earthquake in South America.  
a guessed    b average    c supposed to    d estimated    e approximately
- 10 You'll have to use the stairs, I'm afraid. The lift is out of .....  
a function    b work    c order    d form    e functioning
- 11 Have you seen a mug anywhere, Roy? We seem to be one .....  
a missed    b less    c under    d deficient    e short
- 12 We got a very good ..... in the newspaper this morning. They must have liked the play.  
a critic    b article    c advertisement    d write-up    e praise

- 13 There was a flash of lightning quickly followed by a loud ..... of thunder.  
a bang    b clap    c smash    d noise    e stroke
- 14 I can't eat this meat; it's too .....  
a strong    b soggy    c tough    d bad    e tender
- 15 Is there anything ..... you'd like me to do?  
a else    b more    c still    d yet    e again
- 16 Don't tell Anne about Paul and Jane breaking up—you know what a/an ..... she is; it will be all over the town in no time.  
a talker    b liar    c gossip    d scavenger    e informer
- 17 One day I'm going to find a/an ..... of land somewhere in the country and build a house on it.  
a area    b plot    c ground    d patch    e tomb
- 18 I was caught parking on a double yellow line and had to pay a £5 parking .....  
a fine    b bait    c summons    d fee    e cost
- 19 David's married Elizabeth Green? No, I don't believe it! You're pulling my .....!  
a toe    b leg    c mind    d hair    e arm
- 20 The position of monarch is not something that is chosen by the people. It is .....  
a inherit    b generated    c hereditary    d descended    e passed over

## 20 Missing words – 'he said', etc.

Put the following words into the correct sentences. Use each word once only.

boasted	pleaded	demanded
complained	snapped	shouted
suggested	stammered	inquired
whispered	insisted	explained

- 1 "What about going to the cinema tonight?" he .....
- 2 "Oh, but you can't go yet. You must stay for another drink at least," she .....
- 3 "Can you tell me where she lives?" ..... the policeman.
- 4 "I want my money back!" ..... the irate housewife.
- 5 "Oh, will you shut up!" ..... the mother to her two children.
- 6 "I love you, Jane," he ..... tenderly.
- 7 "I can play ten musical instruments," she .....
- 8 "Help! I can't swim! Help!" ..... the girl as she went under the water for the second time.
- 9 "You see, darling, it's like this," ..... the girl's fiancé. "I just can't afford to get married at the moment."
- 10 "Please don't kill me!" ..... the girl as the hi-jacker pointed his gun at her.
- 11 "It's not fair," ..... the girl to her mother. "I never get invited to parties."
- 12 "W . . . w . . . will you m . . . m . . . marry me?" he .....

# 21 Phrasal verbs 2

Replace the words in brackets in the following sentences with a suitable phrasal verb. (Make any other necessary changes.)

let off	go off	fall out
go through with	turn away	go with
do up	put up with	get out of
turn out	go over	put up
come round	get round to	put off
take for	come apart	get through to

- Do you think you could ..... this work with me some time, Pete?  
(examine)
- The teacher suspected that one of the class had stolen the money, so he made them all ..... their pockets.  
(empty)
- You look upset, Sven. Have you and Inger ..... again?  
(quarrelled)
- I tried to have lunch at the Savoy yesterday, but was ..... because I wasn't wearing a tie.  
(refused admittance)
- Guess what, Sue? I was ..... John Travolta last week. It was a great feeling!  
(mistaken for)
- Paul, do you think you could ..... me ..... for the night? It's a bit too late to go home now.  
(give me a place to sleep)
- Many things are so badly made nowadays that they often ..... after only a few weeks.  
(break into pieces)

- He was caught shop-lifting but since this was his first offence he was ..... with a warning.  
(allowed to go free)
- I didn't really want to play football on Saturday, but since there was no one else to take my place I couldn't really ..... it.  
(escape from doing)
- Could you help me ..... this parcel, please, Tom?  
(wrap)
- I don't know how she ..... him. She must have the patience of a saint.  
(tolerates)
- You never listen to me, Eva, do you? It's impossible to ..... you these days!  
(reach)
- I think David's ..... me. He hasn't told me he loves me for over a week.  
(stopped liking)
- The girl was relieved when her boyfriend ..... after having fainted half-way through the Pop Concert.  
(regained consciousness)
- I like your blouse, Sally. It ..... your skirt.  
(matches)
- I know you find the course boring, Pauline, but since you've started it you might as well ..... it.  
(complete)
- The only thing that ..... me ..... getting married is the thought of having to sleep in the same room as someone else.  
(discourages me from)
- I keep meaning to write to my parents but I'm so busy nowadays that I can't seem to ..... it.  
(find the time to do)



## 22 Puzzle it out – who won the 2.15 race?

Here are the horses and betting odds for the 2.15 race at Kempton Park:

No.	Horse	Betting odds
1	ROYAL THRUST	25-1
2	DAVY LAD	2-1 (Fav.)
3	SPITTING IMAGE	10-1
4	RED RUM	5-1
5	WAR BONNET	10-1
6	FORT VULCAN	10-1
7	THE SONGWRITER	50-1
8	WILLY WHAT	50-1

Now read through the following sentences and see if you can work out who came 1st, 2nd and 3rd in the above race.

Fort Vulcan was in the lead with 2 furlongs to go.

There were only six finishers.

The horse that came second was an outsider (more than 20-1)

The Songwriter came last.

The favourite was in the lead with only 1 furlong to go.

The winning horse had odds of 10-1.

Royal Thrust fell at the third jump.

Red Rum passed the favourite half a furlong from the finish.

War Bonnet did not finish the race.

Horse number 6 came 5th.



3rd. .... 2nd. .... 1st. ....

(Note: 1 furlong = 1/8 English mile)

## 23 Add two letters

Add **two letters** to each of the following words (in any place) to form a new word. A clue is given to help you.

1 SIT	<u>SIXTH</u>	ordinal number
2 SEE	.....	shop assistants do it
3 WAY	.....	very tired
4 LAY	.....	tall and very thin
5 CART	.....	a vegetable
6 RAGE	.....	a fruit
7 WAR	.....	it's good for the garden
8 DAY	.....	a short holdup
9 EAT	.....	it comes to everyone
10 OR	.....	part of an apple
11 RIPE	.....	helps you cook
12 DEAR	.....	dull or boring
13 COME	.....	opposite of expenditure
14 HAY	.....	most people would like to be this
15 ROW	.....	a lot of people
16 TEN	.....	frequently
17 SAW	.....	you wear it
18 SAD	.....	can be tiring to do this for a long time
19 BAND	.....	it tastes nice, especially with coffee
20 RUG	.....	popular game in Wales
21 SEEN	.....	a country
22 CARE	.....	you walk on it
23 SET	.....	a piece of linen
24 STALE	.....	used in an office
25 POLE	.....	opposite of discourteous



# 24 Crime and punishment

Fill in the missing words in the sentences below. Choose from the following:

arrested	remanded in custody	defence
solicitor	evidence	barrister
verdict	proof	witness
fine	charged	testimony
juvenile delinquent	sentenced	arson
bail	Magistrate's Court	burglary
prosecution	probation	imprisonment
commit	embezzlement	
shoplifting	Crown Court	

- The number of young people who ..... crimes has risen sharply in recent years.
- Another house was broken into last week. This is the third ..... in the area in the past month.
- The judge ..... him to seven years' ..... for armed robbery.
- After twelve hours, the Jury finally reached its .....; the prisoner was guilty.
- Although the police suspected that he had been involved in the robbery, since they had no definite ..... there was nothing they could do about it.
- He parked his car in the wrong place and had to pay a £20 parking .....
- This is the fourth fire in the area recently. The police suspect .....
- The shop decided to install closed-circuit television in an effort to combat the problem of .....
- He was ..... by the police outside a pub in Soho and ..... with murder.
- There are two criminal courts in Britain—the ..... for minor offences and the ..... for more serious ones.
- A ..... is a young person who breaks the law.

- A ..... is someone who sees a crime being committed.
- The lawyer who prepares the case for his or her client prior to appearing in court is called a ..... The lawyer who actually presents the case in court is called a .....
- The sum of money left with a court of law so that a prisoner may be set free until his or her trial comes up is called .....
- The bank manager admitted taking £250,000 of the bank's money during the previous five years. He was found guilty of .....
- The witness held the Bible in her right hand and said: "I swear by Almighty God that the ..... I shall give shall be the truth, the whole truth, and nothing but the truth."
- The formal statement made by a witness in court is called a .....
- If a person is ....., this means that he or she is put in prison before his or her trial comes up.
- Since it was his first offence, he was not sent to prison but put on ..... for 6 months.
- At a trial, the barrister who speaks for the accused is called the Counsel for the ....., while the barrister who speaks against him is called the Counsel for the .....

# 25 Crossword – things in the home

Look at the drawings and fill in the crossword below.

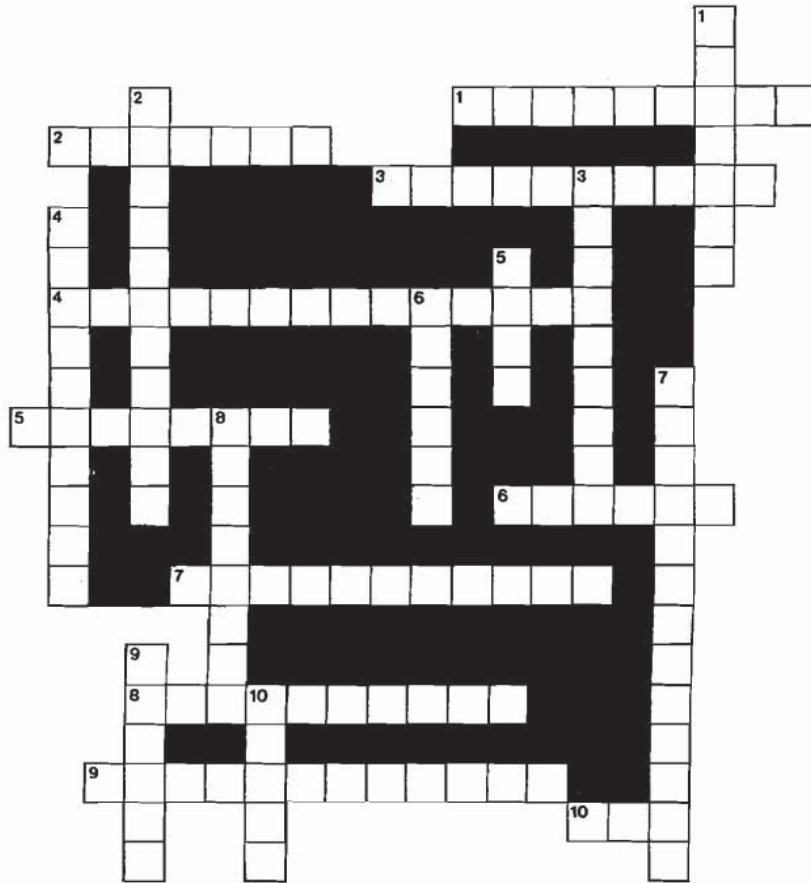

## ACROSS

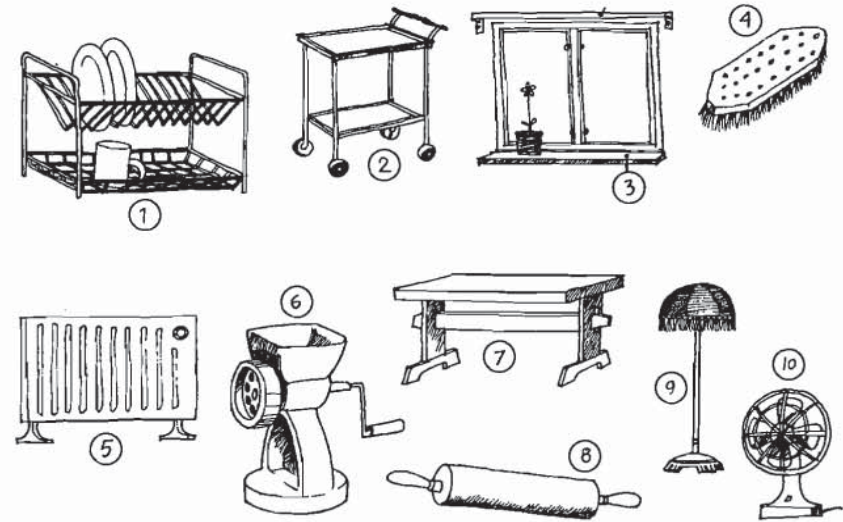

## DOWN

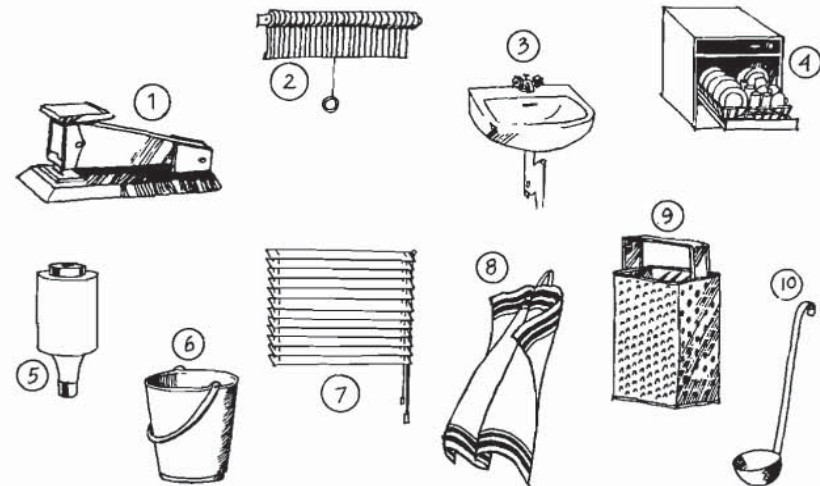

# 26 Classifications

Write one name for each of the following groups. Before starting, look at the example.

- 1 spring, summer, autumn, winter
- 2 carton, barrel, crate, bag
- 3 triangle, circle, square, rectangle
- 4 button, clasp, hook and eye, press studs
- 5 mahogany, pine, teak, birch
- 6 pheasant, partridge, grouse, rabbit
- 7 coffee, tea, chocolate, cocoa
- 8 sewing, knitting, crochet, embroidery
- 9 and, but, because, even though
- 10 bungalow, penthouse, hut, villa
- 11 1/2, 1/4, 3/4, 5/4
- 12 clubs, hearts, diamonds, spades
- 13 brass, bronze, pewter, chrome-nickel
- 14 astronomy, biology, botany, sociology
- 15 C.I.A., O.B.E., Ph. D., N.B.
- 16 amethyst, emerald, onyx, opal
- 17 ammonia, carbon dioxide, ether, methane
- 18 clay, salt, gypsum, lime
- 19 chronometer, grandfather clock, metronome, stopwatch
- 20 fish and chips, roast beef and Yorkshire pudding, bacon and eggs, shepherd's pie

S	E	A	S	O	N	S			
C			A						
H									
	S		N						
I		R							
	E								
E		R							
		D	C			T			
O		U		T					
D		L							
R			I						
S									
L		S							
C			E						
B		V		T					
E									
	S								
I		R							
T		P							
		H							

# 27 From shore to crash

Change the word SHORE into CRASH in sixteen stages, changing one or two letters at a time. (The number in brackets after each clue tells you how many letters of the preceding word need to be changed to form the new word.)

	S	H	O	R	E	
1						e.g. 2-0 (1)
2						to frighten (1)
3						to do with music (1)
4						a mammal (2)
5						a conjunction (1)
6						a sign of pleasure, happiness (2)
7						an odour (2)
8						foreigners often find it difficult to do this in English (1)
9						parents should try not to do this to their children (2)
10						a country (2)
11						a means of transport (2)
12						a ..... of sand (1)
13						a fruit (2)
14						cows do this (1)
15						to rub out (2)
	C	R	A	S	H	



# 28 British and American English

Write down the missing British or American words.

AMERICAN ENGLISH      BRITISH ENGLISH

- 1 bill (money) .....
- 2 ..... chimney
- 3 monkey wrench .....
- 4 ..... handbag
- 5 flashlight .....
- 6 ..... sellotape
- 7 yard .....
- 8 ..... vest
- 9 tag .....
- 10 ..... telegram
- 11 street musician .....
- 12 ..... lamppost
- 13 blow-out .....
- 14 ..... caravan
- 15 mortician .....
- 16 ..... fire brigade
- 17 sideburns .....
- 18 ..... pram
- 19 sucker .....
- 20 ..... holiday



# 29 Missing words – ‘he walked’, etc.

Put the following words into the correct sentences. Use each word once only.

stumbled	staggered	plodded.
limped	strode	loitered
skipped	strolled	crept
marched	scampered	tramped

- 1 The angry man ..... into the office and demanded to see the manager.
- 2 The soldiers proudly ..... past the cheering crowds lining the streets.
- 3 The tired farmer ..... home after a hard day's work in the fields.
- 4 The girl ..... and fell as she was coming out of the office.
- 5 The mouse ..... into its hole the moment it caught sight of the cat.
- 6 We'd have caught that train if you hadn't ..... on the way!
- 7 The wounded man ..... into the pub, crying, "Call an ambulance. I've been stabbed!"
- 8 The happy children ..... along the road on their way to school.
- 9 We ..... across the fields for miles and miles in search of mushrooms.
- 10 The lovers ..... hand-in-hand through the park.
- 11 The lame man ..... across the room.
- 12 The soldier ..... silently towards the unsuspecting enemy guard.



# 30 Objects and things in the home 2

Write the number of each drawing next to the correct word.

- duster .....
- flex .....
- toast rack .....
- slide rule .....
- headboard .....
- pressure cooker .....
- continental quilt .....
- wrench .....
- brace .....
- bit .....
- flannel .....
- skirting board .....

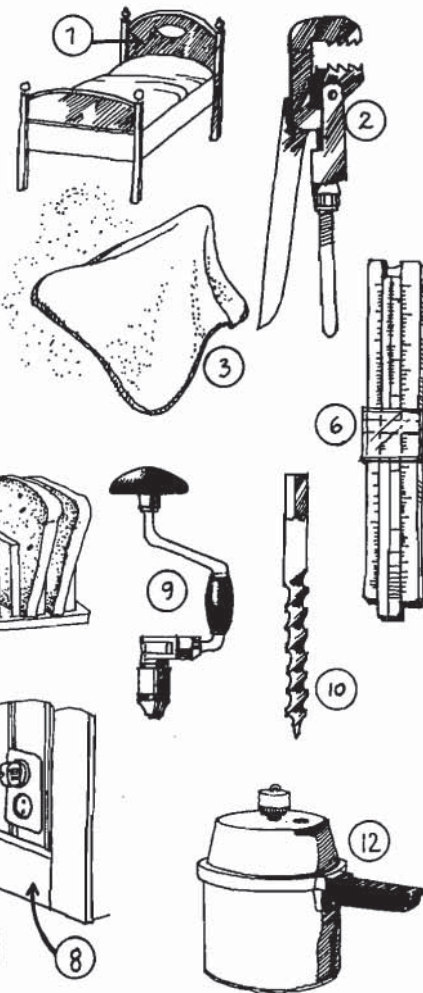

# 31 Prepositional phrases 2

Fill in the missing prepositions in the following sentences.

- 1 He went abroad ..... *business*.
- 2 I was ..... *a hurry*, so I chose a book ..... *random*.
- 3 The tomb was discovered ..... *accident*.
- 4 I can't get ..... *touch* ..... him. His telephone is .....
- ..... *order*.
- 5 Have you anyone ..... *mind* ..... the job?
- 6 He has collected over a thousand signatures ..... *support* .....
- his protest.
- 7 This is Mrs Brown. She's ..... *charge* ..... production.
- 8 Help! Help! My house is ..... *fire*!
- 9 I'll have a beer. No, ..... *second thoughts*, I'll have a whisky.
- 10 Hands up those ..... *favour* ..... going to Brighton.
- 11 Prepositions have to be learnt ..... *heart*.
- 12 Mrs Brown has cleaned the house ..... *top* ..... *bottom*.
- 13 Thousands of people turned up for the concert ..... *spite* .....
- the bad weather.
- 14 Your work is quite good ..... *the whole*.
- 15 He stepped on my toe ..... *purpose*.
- 16 He is very extravagant and is always ..... *debt*.
- 17 It is a good idea to *keep* ..... *good terms* ..... your teacher.
- 18 Although you have to give up a lot when you have children, it's probably worth it ..... *the long run*.
- 19 Let's go to the cinema this weekend ..... *a change*.
- 20 I've just bought a new house ..... *the outskirts* ..... Brighton.

# 32 Colloquial expressions 2

Replace the words in brackets in the following sentences with a suitable colloquial expression from the list below.

on the house	like a bear with a sore head	call it a day
given a good hiding	head	put your foot in it
I haven't a clue	given the sack	talking shop
for donkey's years	keep it quiet	out of the blue
pull your socks up	gets my goat	I can't make head or tail of it
	rings a bell	

- 1 I don't mind helping Charles with his English, but what .....  
(annoys me)  
..... is the way he seems to take my help for granted.
- 2 The news that the Prime Minister was going to resign came quite .....  
(unexpectedly)  
.....
- 3 Well, I think we'd better ..... now. We've done  
(stop working)  
as much as we can for one day.
- 4 What's wrong with Mr Barker this morning? He's .....  
(so irritable)  
.....
- 5 I don't think I've met her, but her name .....  
(sounds familiar)
- 6 Have you seen Mary? I've been looking for her all morning.  
Sorry, John. ...., I'm afraid.  
(I don't know)
- 7 Right everybody, place your orders. The drinks are .....  
(free)
- 8 I hate going to parties with groups of teachers. They seem to spend most of the evening .....  
(talking about their work)

- 9 By the way, you've heard about Tom, haven't you? He's been .....  
(dismissed)  
.....  
from his job)
- 10 I wonder what Julia's doing these days? I haven't seen her .....  
.....  
(for a long time)
- 11 The child was ..... by his father for telling lies.  
(beaten)
- 12 What's this supposed to mean? .....  
(I can't understand a word of it)
- 13 Incidentally, Rita and Jim have decided to get married. But .....  
(don't tell anyone)  
..... — it's supposed to be a secret.
- 14 You really ..... when you asked Pam how her cat was. Didn't you  
(blundered)  
know it got run over last week?
- 15 You're going to have to ..... if you want to pass  
(work much harder)  
the exam.

# 33 Sounds

Fill in the correct words under each drawing.

the ring of  
the howling of  
the beat of  
the report of  
the crack of  
the screeching of  
the chime of  
the murmur of  
the blast of  
the pealing of  
the wail of  
the clanking of



..... a drum



..... an explosion



..... a telephone



..... a clock



..... chains



..... a whip

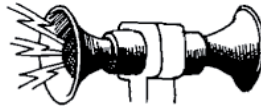

..... a siren



..... a stream



..... bells



..... the wind



..... a rifle



..... brakes

# 34 Which word is the same?

Underline the word which is closest in meaning to the first three words in each line. Number 1 has been done for you.

- 1 LOVE, LIKE, ENJOY
- 2 DECEIVE, FOOL, CHEAT
- 3 OBDURATE, STUBBORN, OBSTINATE
- 4 EAGER, KEEN, ENTHUSIASTIC
- 5 TRY, ENDEAVOUR, ATTEMPT
- 6 CUNNING, CRAFTY, SLY
- 7 ORDER, COMMAND, DICTATE
- 8 REQUEST, BEG, ASK
- 9 WEALTHY, RICH, PROSPEROUS
- 10 DISLIKE, HATE, LOATHE
- 11 BRAVE, PLUCKY, BOLD
- 12 PROUD, VAIN, ARROGANT
- 13 ASTONISH, AMAZE, ASTOUND
- 14 WHOLE, TOTAL, SUM
- 15 EVENT, RESULT, CONSEQUENCE
- 16 WEAK, FEEBLE, POWERLESS
- 17 REGION, AREA, ZONE
- 18 STOUT, FAT, OBESE
- 19 DEPARTURE, WITHDRAWAL, RETREAT
- 20 KILL, SLAY, ASSASSINATE

- hope, hate, adore, raise  
swindle, lose, lyre, drop  
stable, adamant, envious, stale  
careful, interesting, strong, zealous  
undertake, make, construct, prove  
careful, artful, queer, inept  
claim, steer, decree, desire  
assure, entreat, require, wish  
affluent, noble, destitute, mean  
vomit, scour, abhor, stand  
moody, feeble, strict, valiant  
conceited, stolen, heady, regal  
favour, bewilder, increase, revise  
amount, number, entirety, figure  
reason, outcome, substitute, change  
stark, slow, impotent, able  
district, neighbour, suburb, border  
shock, corpulent, stark, puny  
arrival, entry, exodus, loss  
load, slaughter, die, lead off



# 35 Fastenings/fasteners

Write the number of each drawing next to the correct word.

- anchor .....
- sling .....
- clip .....
- chain .....
- stitch .....
- joint .....
- bolt .....
- harness .....
- handcuffs .....
- cable .....
- tacks .....
- zip .....
- rivet .....

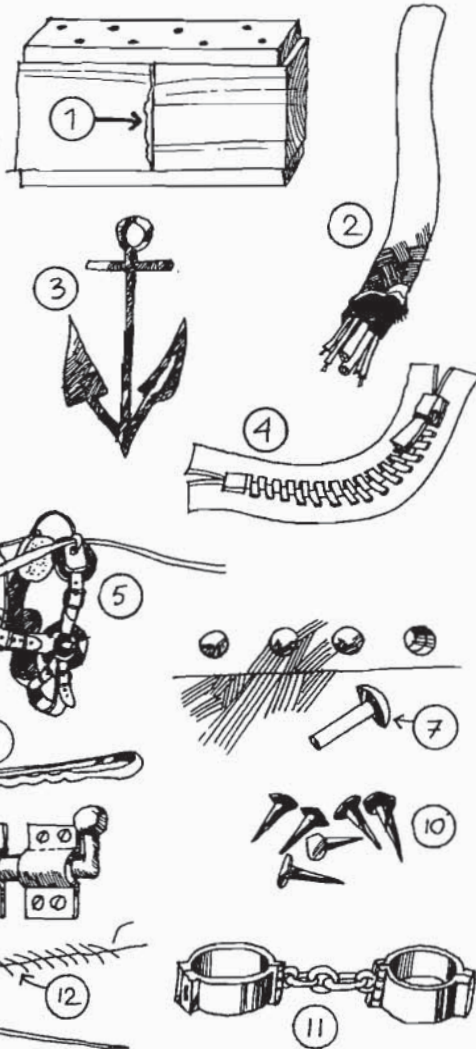

# 36 What is it part of?

Complete the following sentences by choosing an appropriate word from the ones on the right. Look at the example first.

- 1 A viewfinder is part of A CAMERA
- 2 A frame is part of .....
- 3 A rafter is part of .....
- 4 A pip is part of .....
- 5 A neck is part of .....
- 6 An eye is part of .....
- 7 A petal is part of .....
- 8 A prong is part of .....
- 9 A key is part of .....
- 10 A pawn is part of .....
- 11 A twig is part of .....
- 12 A beak is part of .....
- 13 A lapel is part of .....
- 14 An arm is part of .....
- 15 A blade is part of .....
- 16 A spine is part of .....
- 17 A flue is part of .....
- 18 A barrel is part of .....
- 19 A hem is part of .....
- 20 A sole is part of .....

- a needle
- a jacket
- a book
- a typewriter
- a shoe
- a chair
- a window
- a bottle
- a knife
- a roof
- a camera
- a dress
- a fork
- a chess set
- a flower
- a rifle
- a bird
- an orange
- a branch
- a chimney



# 37 Health words

Fill in the missing words in the sentences below. Choose from the following:

matron	antiseptic	Maternity Ward
surgeon	indigestion	general anaesthetic
family doctor	hay fever	measles
contagious	sedative	insomnia
midwife	X-ray	prescription
constipated	infectious	crutches
mumps	surgery	scald

- In England, if you are ill you can either send for the ..... or else go and visit him at his .....
- The piece of paper you get from the doctor to take to the chemist's to obtain medicine, pills, etc. is called a .....
- My wife is expecting a baby. She's in the ..... of Buchanan Hospital at the moment.
- Be careful with that boiling water; you might ..... yourself!
- If a disease is !....., it means it can be spread from person to person, especially in the air. On the other hand a ..... disease is one which can only be spread from person to person by direct contact (or touch).
- ..... is an illness, something like a bad cold, which makes the person sneeze a lot. It is caused by breathing in pollen dust from plants.
- A ..... is a nurse who has received special training to help other women when they are giving birth to children.
- His neck and mouth are swollen. I think he's got .....
- Don't eat your food so quickly! You'll get .....
- You'd better put some ..... on that cut, just to be safe.
- It must be ..... She's got a fever, and look at all those small red spots on her face and body.
- If you suffer from ....., your doctor may recommend taking sleeping tablets.
- I think I'm ..... I haven't been able to go to the toilet properly for days.
- When she broke her leg, she had to go around on ..... for several weeks afterwards.
- You may have broken one of your ribs. I think we'd better take an ....., just to make sure.
- A ..... is a doctor whose job is to perform operations.
- She was in such a state when her son died that the doctor gave her a ..... to help calm her down.
- Before you have an operation, you are usually given a ..... to make you unconscious so that you will not feel any pain during it.
- The woman in charge of a hospital is called the ..... She has control over all the nurses. (But not the doctors!)

# 38 What are the questions?

Look at the following drawings then write down what the missing questions and answers are. The questions you will have to make up yourself but you can choose the answers from the ones below.

- a No, I'd better not, thanks. I'm driving.
- b No, of course not. I've only just arrived myself.
- c I can't, I'm afraid. I'm already married.
- d I'm sorry, but there's no one called John living here. You must have got the wrong number.
- e No, it's all right, thank you. I can manage.
- f Er... almost three.
- g Not too bad, thanks. But I don't really like flying.
- h I'm sorry, I'm a stranger here too.
- i Yes, two lumps, please.
- j Well, we were thinking of going to Poland for a change. It was so crowded last year in Spain.
- k Er... it's the 5th I think.
- l No, thanks. I've given it up.

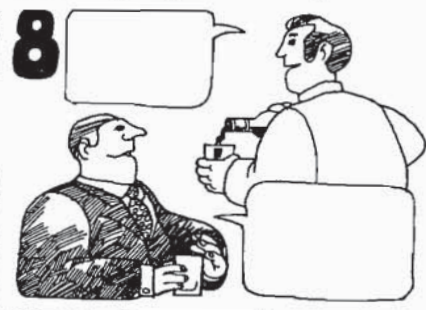

# 39 Idioms of comparison

There are many short comparisons used in English to make the language more vivid and clear. Below are thirty of the most common ones. Complete each of them with a suitable word or words. Choose from the following:

a bat	chalk from cheese	mustard	the nose on your face
brass	a lord	life	the grave
a berry	a fiddle	a feather	a fox
a bee	a pancake	a hatter	a rock
a bell	a daisy	the hills	toast
a cucumber	gold	a church mouse	two peas in a pod
a doornail	nails	a picture	
a post	lead	clockwork	

- 1 As mad as .....
- 2 As flat as .....
- 3 As dead as .....
- 4 As heavy as .....
- 5 As light as .....
- 6 As regular as .....
- 7 As blind as .....
- 8 As different as .....
- 9 As clear as .....
- 10 As plain as .....
- 11 As like as .....
- 12 As cunning as .....
- 13 As hard as .....
- 14 As busy a .....
- 15 As keen as .....
- 16 As poor as .....
- 17 As steady as .....
- 18 As deaf as .....
- 19 As fit as .....

- 20 As pretty as .....
- 21 As bold as .....
- 22 As drunk as .....
- 23 As cool as .....
- 24 As warm as .....
- 25 As old as .....
- 26 As fresh as .....
- 27 As large as .....
- 28 As silent as .....
- 29 As good as .....
- 30 As brown as .....





# 42 Cartoons

In the following cartoons, the captions (i.e. the words that go with a cartoon) have got mixed up so that each cartoon has been printed with the wrong caption under it. Work out the correct caption for each cartoon.

Cartoon	Correct caption	Cartoon	Correct caption
1	.....	6	.....
2	.....	7	.....
3	.....	8	.....
4	.....	9	.....
5	.....	10	.....

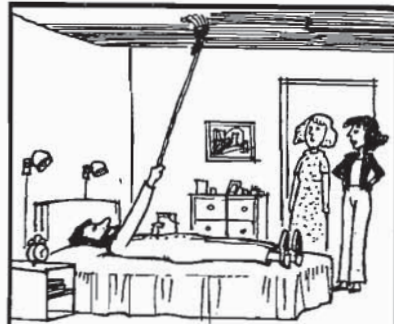

**1** ARE YOU SURE IT'S A GOLDFISH, FRANK?



**2** BUT WHAT MAKES YOU THINK PEOPLE WALK ALL OVER YOU, MRS GROVE?



**3** BUT ISN'T THERE ANYTHING ELSE YOU'RE GOOD AT?



**4** A TABLE NEAR THE ORCHESTRA, PLEASE.



**5** LISTEN, THEY ARE PLAYING OUR TUNE.



**6** CAN I RUN YOU HOME?



**7** BUT WHAT MAKES YOU THINK THE BANANA DIET'S NOT WORKING, MRS BRIGHT?



**8** HE'S ALWAYS BEEN A BIG FAN OF MICHELANGELO.

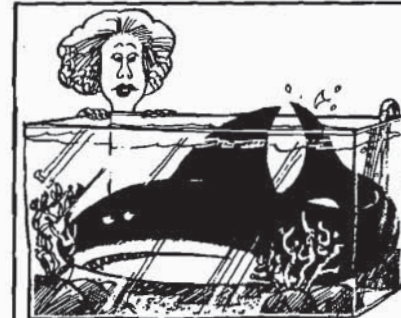

**9** THERE MUST BE AN EASIER WAY TO KILL THEM, FRED!



**10** IT'S THE COMMUTING THAT REALLY GETS ME DOWN.



# 43 Bits and pieces

Write the number of each drawing next to the correct word.

- |                 |       |
|-----------------|-------|
| roundabout      | ..... |
| knitting needle | ..... |
| nappy           | ..... |
| roof tiles      | ..... |
| scaffolding     | ..... |
| kerb            | ..... |
| firework        | ..... |
| music stand     | ..... |
| skipping rope   | ..... |
| telegraph pole  | ..... |
| parting         | ..... |
| drain           | ..... |
| pawn            | ..... |
| skylight        | ..... |
| udder           | ..... |
| gutter          | ..... |
| crutches        | ..... |
| cuff            | ..... |
| straw           | ..... |
| plimsoll        | ..... |

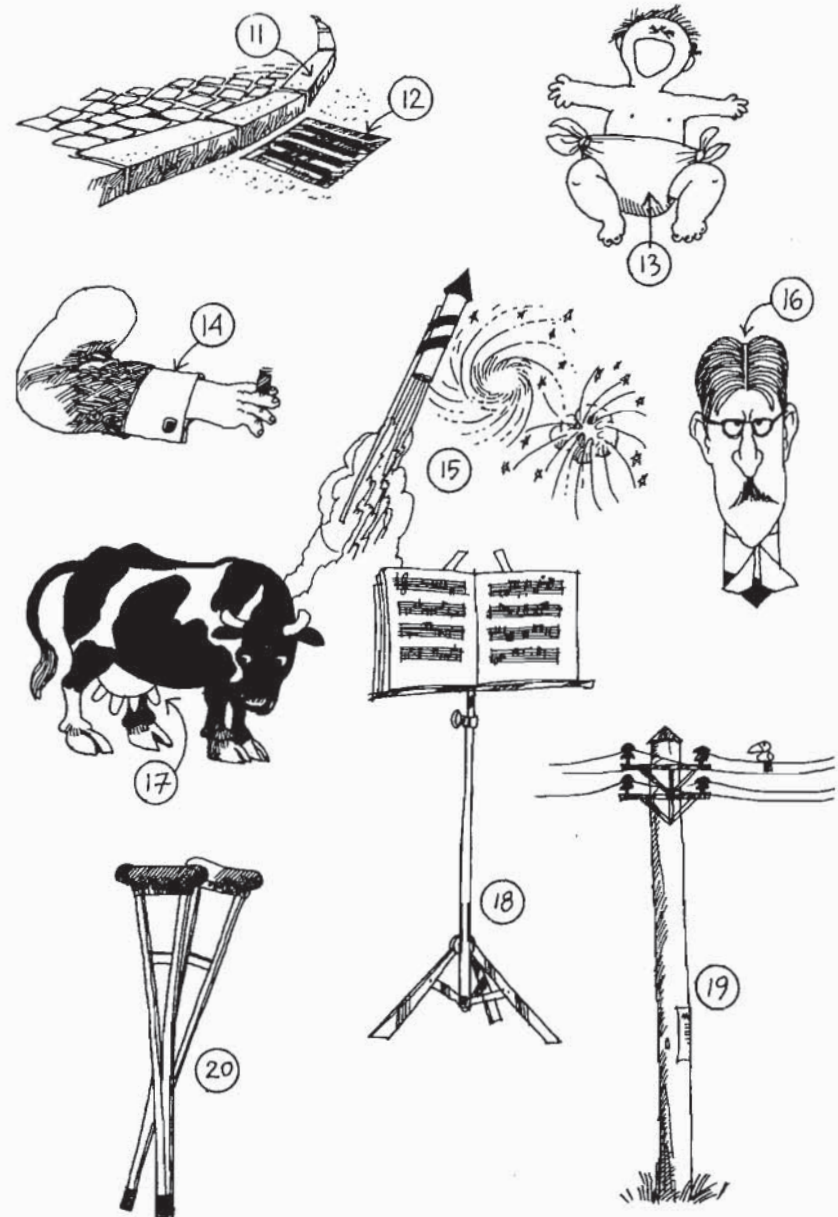
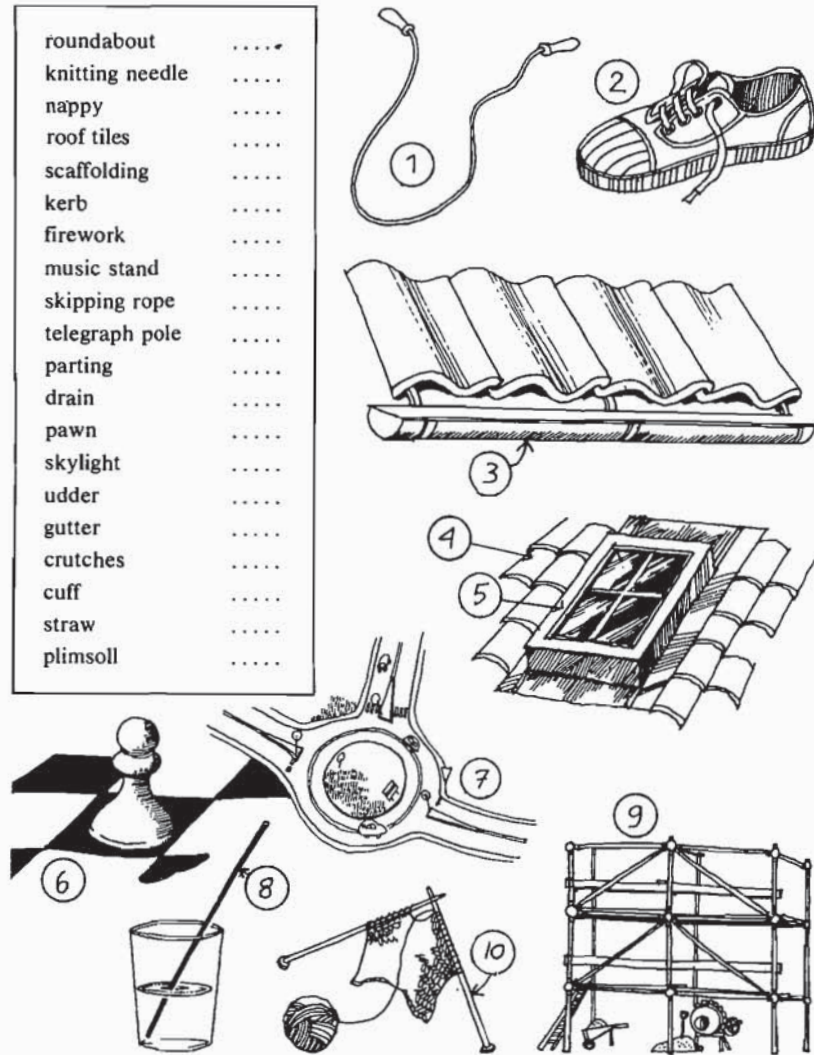



# 44 Synonyms and opposites crossword – various words

Read through the sentences below and fill in the crossword.

## ACROSS

- 1 The opposite of the noun **profit**.
- 2 The opposite of the adjective **sweet**.
- 3 The opposite of the noun **exit**.
- 4 The opposite of the adjective **brave**.
- 5 A synonym for the verb **to boast**.
- 6 The opposite of the noun **punishment**.
- 7 The opposite of the verb **to improve**.
- 8 The opposite of the noun **landlord**.
- 9 A synonym for the adverb **especially**.
- 10 A synonym for the verb **to allow**.
- 11 The opposite of the adjective **useful**.

## DOWN

- 1 A synonym for the verb **to receive**.
- 2 A synonym for the verb **to hide**.
- 3 The opposite of the verb **to admit**.
- 4 A synonym for the noun **argument**.
- 5 A synonym for the noun **mistake**.
- 6 A synonym for the verb **to hate**.
- 7 The opposite of the adjective **fertile**.
- 8 A synonym for the adjective **eager**.
- 9 A synonym for the adjective **naughty**.
- 10 A synonym for the verb **to disappear**.
- 11 The opposite of the verb **to praise**.
- 12 A synonym for the noun **cure**.
- 13 The opposite of the verb **to accept**.

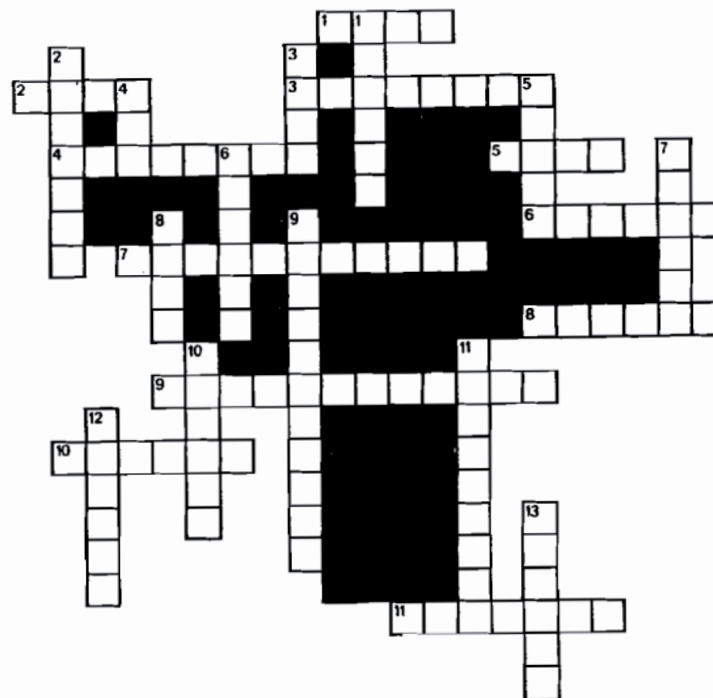

# 45 Missing words – ‘a breath of’, etc.

Put the following words into the correct sentences. Use each word once only.

stroke	breath	pinch
clap	attack	whiff
stretch	spell	plot
hint	shock	flash
wink	speck	gust

- 1 Just before the curtain went up, the actor suddenly developed a frightening ..... of nerves.
- 2 I'm so tired. I didn't get a ..... of sleep last night.
- 3 I know he sounds very convincing, but if I were you I'd take everything he says with a ..... of salt.
- 4 I had a fantastic ..... of luck last weekend. I picked up a genuine Stradivarius violin for only £25.
- 5 As he was walking past the building site he got a tiny ..... of dust in his eye.
- 6 We've been having a marvellous ..... of warm weather lately.
- 7 The neighbours must be eating garlic again. I just got a ..... of it as I passed their door.
- 8 They have just opened a new ..... of motorway between Brighton and London.
- 9 The sky was very black and a sudden ..... of lightning made them all jump. They jumped even more when it was followed by a loud ..... of thunder.
- 10 It's so stuffy in here. I really must go outside for a quick ..... of fresh air.

- 11 There is a 3-acre ..... of land for sale next to my house.
- 12 He was a tall, well-built man with a ..... of red hair.
- 13 I was working at my desk when a sudden ..... of wind blew all my papers onto the floor.
- 14 Now remember, Dave, send for the police at the slightest ..... of trouble.

# 46 Newspaper misprints

In each of the following extracts from a newspaper there is a misprint. Underline the word which is wrong and also write down which word should have been used instead (see example).

- 1 Pamela Smith has been awarded the R.S.P.C.A. bronze medal for rescuing a car trapped up a tree. (.....CAT.....)
- 2 Some members of the Bulgarian secret police accepted brides in connection with the shipments. (.....)
- 3 Part-time assistant required for sweat shop in Bexhill. (.....)
- 4 Mature and considerable lady required to provide companionship to elderly lady. (.....)
- 5 Mr Chris A. Gibson of New Zealand spoke next. His was also a humorous address, full of amusing antidotes. (.....)
- 6 For Sale: Satan wedding dress, £30. (.....)
- 7 He became champion by eating most of his main rivals. (.....)
- 8 The Planning Board wants to make the village of Little Hampton a conversation area. (.....)
- 9 This is a very serious offence which we shall have to deal with severely, as a detergent to anyone in the same mind. (.....)
- 10 Window, mid-50s, youthful outlook, seeks company of tall, educated gentleman. (.....)
- 11 With escalating fuel bills it is essential that your home is properly insulted. (.....)
- 12 Father O'Connor, who is appearing in a show on behalf of the hospital, only sins for charity. (.....)
- 13 She lectures on nutrition and health. But they say she is inconsistent and will eat five deserts in a sitting. (.....)
- 14 Unlike most cats, Mrs P. explained, hers—owing to an eye injury—could hardly pee at all in the dark. (.....)
- 15 Both were smartly dressed in three-piece suites. (.....)
- 16 A bicycle worth £130 has been stolen from a mouse in Bolton. (.....)
- 17 Fully killed mechanic required for busy garage. (.....)
- 18 The problem of preventing violence in classrooms is a far wider one. Capital punishment is allowed in most schools but teachers are reluctant to use it. (.....)

- 19 The farmer, who asked not to be named, said: "I was moving the lawn when I heard the plane go over." (.....)
- 20 Jane met her husband while on holiday in Cyprus. "Chris was a member of the United Nations peach keeping force out there." (.....)
- 21 Gale warnings have been issued for all land and sea areas, and guests of 78 m.p.h. were recorded off Dungeness. (.....)
- 22 Cooked school meals are to be scraped next September by Bromley Council. (.....)
- 23 Have your Christmas dinner with us in our intimate restaurant with log fires burning and good wood being served. (.....)
- 24 A crucifix, given by Mr York to the church, was a wedding present to his parents. (.....)
- 25 TO LET: Furnished flat, £60 per month (rats inclusive). (.....)



# 47 Colloquial expressions 3

Replace the words in brackets in the following sentences with a suitable colloquial expression from the list below.

get butterflies in my stomach	blowing his own trumpet	let the cat out of the bag
pulling my leg	hold my tongue	pig-headed
for a song	an out-and-out	he wouldn't say 'Boo' to a goose
smell a rat	as right as rain	cheesed off
to keep a straight face	down the drain	
	get on like a house on fire	

- 1 I see John's ..... again. I've just  
(boasting)  
heard him telling everyone he's the best tennis player in the County.
- 2 We were hoping to keep our engagement a secret, but my mother .....  
(told  
.....  
everyone about it)
- 3 I always ..... before an interview.  
(feel nervous)
- 4 We all found it difficult ..... when  
(not to laugh)  
we noticed that our teacher had forgotten to do up the zip on his trousers.
- 5 Well, that's £5 ..... I told you that  
(wasted)  
play wasn't worth seeing!
- 6 I must say that I found it hard to .....  
(remain silent)  
when he started saying all those horrible things about foreigners.
- 7 You're not frightened of Mr Biggs, are you? .....  
(He's very timid really)  
.....

- 8 I believed Ian when he told me he'd lost his job, but I later found out from Inger  
that he was only .....  
(joking)
- 9 You look a bit ....., John. What's  
(fed up)  
the matter?
- 10 The holiday was ..... disaster. So  
(a complete)  
many things went wrong that it would take me all day to tell you about it.
- 11 I got a 1981 Jaguar the other day .....  
(very cheaply)  
The owner was going abroad, so he just wanted to sell it quickly.
- 12 My wife will never admit that she's wrong, even when she knows she is. She's  
so .....  
(stubborn)
- 13 Just keep him at home today, Mrs Brown, and he'll be .....  
(perfectly all right)  
..... by tomorrow.
- 14 I really like my mother-in-law. We .....  
(have a really good relationship)
- 15 I thought she was the new secretary, but I began to .....  
(become suspicious)  
..... when I found her going through coat pockets in the  
cloakroom.

# 48 Words to describe (temporary) moods, states and feelings

Put the following words into the correct sentences. Use each word once only.

sympathetic	winded	terrified	embarrassed
depressed	peckish	pregnant	stiff
drowsy	offended	giddy	despondent
homesick	relieved	sober	preoccupied
tense	weary	nostalgic	disappointed
hoarse	faint	disgusted	dejected
furious	upset	thrilled	
amazed	listless	unconscious	

- 1 My father was ..... when I told him that I had crashed his car. I don't think I have ever seen him so angry.
- 2 After walking for 6 hours, we were so ..... that we couldn't go on.
- 3 I always feel ..... when I look down from the top of a high building.
- 4 My legs are really ..... after all that running we did yesterday.
- 5 The boxer hit his opponent so hard that he was knocked .....
- 6 I feel a bit ..... Do you mind if I help myself to a sandwich?
- 7 Alison was very ..... when she heard that her mother had been taken to hospital.
- 8 When I first moved to Sweden I felt very ..... — I missed England so much.
- 9 She was really ..... when she heard that she had got the job.
- 10 I spoke to her, but she was too ..... to notice me.
- 11 After singing all evening I found that I could scarcely talk afterwards—my voice was really .....

- 12 My sister was ..... when her friend's Alsatian started barking at her.
- 13 She was very ..... when I told her that I had lost my job.
- 14 I felt really ..... when my mother started telling my girlfriend about the strange habits I used to have when I was a child.
- 15 The centre-forward was temporarily ..... when he was kicked in the stomach going for the ball.
- 16 My husband was really thrilled when I told him that I was .....
- 17 When Mary refused to go out with him, John felt really .....
- 18 You look ....., Alan. Cheer up! Things can't be that bad.
- 19 The sight of blood always makes me feel .....
- 20 Listening to 'She Loves You' by the Beatles made me feel very .....
- 21 She felt very ..... when the doctor told her that it wasn't cancer.
- 22 Lying in the sun made me feel very .....
- 23 Amanda was so ..... when she failed her driving-test. She had really set her heart on passing it first time.
- 24 The hotel room was so dirty that I felt thoroughly ..... and complained to the manager.
- 25 My cousin was deeply ..... when I didn't invite him to my wedding.
- 26 When we heard that he had passed the exam we were all ..... No one had thought he would do it.
- 27 I hate the heat—it makes me feel so ..... I just don't want to move or do anything.
- 28 He told me that when his wife left him he felt really ..... Life didn't seem worth living, and he even contemplated committing suicide.
- 29 I felt very ..... before the interview. But once I actually started talking I began to relax.
- 30 Although he was perfectly ..... when he arrived at the party, by 11.30 he was as drunk as everyone else.

# 49 Words beginning with 'de'

Read through the sentences and fill in the missing words, all of which begin with 'de'.  
(*n* = noun, *vb* = verb, *adj* = adjective).

- 1 A fault or imperfection. (*n*)
- 2 Very sad. (*adj*)
- 3 A formal discussion in which people express different opinions about a subject. (*n*)
- 4 To become less; to become smaller or weaker. (*vb*)
- 5 Something you do when you play cards. (*vb*)
- 6 Lacking in something. (*adj*)
- 7 To pull down a building. (*vb*)
- 8 A synonym for reliable. (*adj*)
- 9 To ask (strongly) for something. (*vb*)
- 10 (of food) Very tasty. (*adj*)
- 11 A type of police officer. (*n*)
- 12 A date or time before which something must be done. (*n*)
- 13 'Government of the people, by the people, for the people.' (*n*)
- 14 Used to clean things. (*n*)
- 15 A type of seat (very popular on British beaches). (*n*)
- 16 You put it on your body to reduce bodily odours. (*n*)
- 17 To win a victory over someone; to beat someone. (*vb*)
- 18 Not accidental. (*adj*)
- 19 To dislike very much. (*vb*)
- 20 A large area of sand. (*n*)

1	D	E			C				
2	D	E				S			D
3	D	E		A					
4	D	E		R			S		
5	D	E							
6	D	E			C				T
7	D	E			L		S		
8	D	E		E		D			E
9	D	E				D			
10	D	E			C			U	
11	D	E			C				E
12	D	E		D				E	
13	D	E				R			Y
14	D	E				R	G		
15	D	E		K		H			
16	D	E		D					T
17	D	E					T		
18	D	E				B		R	
19	D	E				S			
20	D	E				R			

# 50 Right or wrong?

Is the word in **bold** type in each of the following sentences used correctly or not? If you think it is, put a tick (✓) in the RIGHT column. If you think it isn't, put a tick in the WRONG column. (You can also try to explain why it is used wrongly.)

	RIGHT	WRONG
1 He stuffs dead animals. He's a <b>taxidermist</b> .	.....	.....
2 I <b>implied</b> from her letter that she's not too happy living in Spain.	.....	.....
3 He had the job before me. He was my <b>predecessor</b> .	.....	.....
4 He works for an advertising agency. He's a <b>copywriter</b> .	.....	.....
5 I had to sack him for stealing – a very <b>tasteless</b> task.	.....	.....
6 The road that you enter and leave a motorway by is called a <b>slip road</b> .	.....	.....
7 Equine is the adjective relating to horses and <b>vulpine</b> to wolves.	.....	.....
8 An <b>understudy</b> works in a theatre.	.....	.....
9 If something is <b>fragile</b> it means it has a sweet or pleasant smell.	.....	.....
10 A <b>malevolent</b> person has a heart of gold.	.....	.....
11 To <b>admonish</b> someone means to punish him or her severely.	.....	.....
12 If you're suffering from <b>amnesia</b> you've lost your memory.	.....	.....
13 <b>Boisterous</b> games are rough and noisy.	.....	.....
14 He was really angry. He was <b>fumigating</b> .	.....	.....
15 An <b>epigram</b> is a short poem or remark that expresses an idea in a clever and amusing way.	.....	.....
16 If a person is <b>coy</b> , he or she is shy and bashful.	.....	.....
17 Her parents are very wealthy. Her father's a <b>marquee</b> .	.....	.....
18 She's written over fifty novels. She's really <b>prolific</b> .	.....	.....
19 <b>Fatuous</b> people suffer more from heart disease than people who are slim.	.....	.....
20 You can't burn it – it's <b>inflammable</b> .	.....	.....



# 51 Who wrote what?

Try to work out who wrote the books below. Choose from the following authors.

Sandy Shaw	Robin Banks	Annie Versary	Percy Vere
Justin Case	Vic Tree	Ivor Headache	Egon Chips
Dinah Mite	G. Howard Hertz	R. Snick	Eileen Dover
Anne O'Rack	Watt C. Dunne	I. Malone	Lotta Kidz
Miss D. Buss	Sue Nora Later	Roland Coffey	I. C. Waters

- 1 **A Long Walk Home** by .....
- 2 **Arrested and Charged!** by .....
- 3 **Bad Breath** by .....
- 4 **Basic Cookery** by .....
- 5 **Canoeing in Antarctica** by .....
- 6 **Celebrating Weddings** by .....
- 7 **Coping with Toothache** by .....
- 8 **Demolition Simplified** by .....
- 9 **Free Falling from Skyscrapers** by .....
- 10 **Get Rich Quick** by .....
- 11 **Holidays by the Sea** by .....
- 12 **How to Cope with a Large Family** by .....
- 13 **It's Bound to Happen** by .....
- 14 **Never Give Up** by .....
- 15 **Outdoor Clothing** by .....
- 16 **Percussion for Beginners** by .....
- 17 **Preparing for the Unexpected** by .....
- 18 **Quick Breakfasts** by .....
- 19 **The Complete Book of Poisons** by .....
- 20 **Winning Ways** by .....

# 52 Group the words

Write the following adjectives under the correct heading (five words under each).

affectionate	elated	hospitable	neighbourly	terrified
apprehensive	exhausted	irate	petrified	thrilled
cheerful	frightened	joyful	scared	tired
cross	furious	livid	shattered	unhappy
depressed	glad	mad	sociable	weary
downhearted	gloomy	miserable	sympathetic	worn-out

<b>ANGER</b>	<b>FATIGUE</b>
<b>FEAR</b>	<b>SADNESS</b>
<b>JOY/HAPPINESS</b>	<b>WARMTH/FRIENDLINESS</b>

# 53 Find the rhyming word

Write down the answers to the following questions.

- 1 Which word is similar in meaning to **intelligent** and sounds like **sight**?
- 2 Which word is similar in meaning to **finish** and sounds like **defeat**?
- 3 Which word is similar in meaning to **spacious** and sounds like **gloomy**?
- 4 Which word is similar in meaning to **attic** and sounds like **soft**?
- 5 Which word is similar in meaning to **enemy** and sounds like **snail**?
- 6 Which word is similar in meaning to **avarice** and sounds like **need**?
- 7 Which word is similar in meaning to **kill** and sounds like **weigh**?
- 8 Which word is similar in meaning to **shorten** and sounds like **late**?
- 9 Which word is similar in meaning to **understand** and sounds like **spend**?
- 10 Which word is similar in meaning to **begin** and sounds like **fence**?
- 11 Which word is similar in meaning to **die** and sounds like **tyre**?
- 12 Which word is similar in meaning to **happen** and sounds like **fir**?
- 13 Which word is similar in meaning to **wander** and sounds like **home**?
- 14 Which word is similar in meaning to **very old** and sounds like **spent**?
- 15 Which word is similar in meaning to **huge** and sounds like **pence**?
- 16 Which word is similar in meaning to **bashful** and sounds like **die**?
- 17 Which word is similar in meaning to **quote** and sounds like **right**?
- 18 Which word is similar in meaning to **despondency** and sounds like **care**?
- 19 Which word is similar in meaning to **accomplish** and sounds like **sleeve**?
- 20 Which word is similar in meaning to **depend** and sounds like **sigh**?

Write your answers here:

- |         |          |          |
|---------|----------|----------|
| 1 ..... | 8 .....  | 15 ..... |
| 2 ..... | 9 .....  | 16 ..... |
| 3 ..... | 10 ..... | 17 ..... |
| 4 ..... | 11 ..... | 18 ..... |
| 5 ..... | 12 ..... | 19 ..... |
| 6 ..... | 13 ..... | 20 ..... |
| 7 ..... | 14 ..... |          |

# 54 One word, two meanings

Find the missing words in the table below.

- 1 to progress ... a fee
- 2 to lose consciousness ... not clear
- 3 a soldier ... confidential
- 4 where a dead person is buried ... serious
- 5 a hilltop ... a forehead
- 6 to let someone in ... to say you are wrong
- 7 a type of boat ... a short, sharp pull
- 8 locks a door ... what a frightened horse might do
- 9 this person lives in northern Europe ... a vegetable
- 10 where pigs are kept ... a sore on the eye
- 11 a military vehicle ... a large container
- 12 an insect ... a popular British sport
- 13 a type of fish ... a deep voice or sound
- 14 a loose outdoor garment ... a large piece of land that sticks out into the sea from a coast
- 15 a tool ... used for holding papers
- 16 to keep out of sight ... an animal's skin
- 17 a building ... to get rid of leaves, skin, etc.
- 18 part of the face ... a religious building
- 19 another name for a ship ... a tube that carries blood
- 20 a beak ... an invoice

1			V				
2					T		
3	P				A		
4		R					
5			O				
6						T	
7							
8					T		
9						E	
10			Y				
11		A					
12		R					T
13				S			
14			P				
15		I					
16					E		
17					D		
18					P		
19			S				
20			L				

## 55 Choose the word 3

Underline the word which best completes the following sentences.

- 1 He fell down while playing tennis and (a sliced b grazed c slashed d skimmed) his knee.
- 2 The bank manager had been (a embezzling b robbing c forging d cheating) large amounts of the bank's money to finance his jet-set way of life.
- 3 It is usually quite difficult to (a overhear b take up c identify d make out) the words when listening to a pop song.
- 4 The best man (a rapped b tapped c hit d beat) the side of his glass lightly with a knife to get the guests' attention.
- 5 I asked the waiter for another cup as the one I was given was (a faulty b broken c defective d chipped).
- 6 You'll have to speak up. My aunt is very (a hard b difficult c unsure d bad) of hearing.
- 7 I couldn't eat the egg as the yolk was too (a fluid b runny c thin d watery).
- 8 She was so (a impressed b mesmerized c fascinated d engrossed) in the book she was reading that she didn't notice us come into the room.
- 9 I can't stop now, Mary, I'm a bit (a lack b short c pushed d rushed) for time. I'll phone you later.
- 10 (a Refreshments b Groceries c Nourishment d Foodstuffs) will be served during the interval.
- 11 You're off to Bangkok you say? What a (a chance b fate c luck d coincidence)! So am I!
- 12 My parents were always making (a fuss b quarrels c arguments d scenes) in public. As a child I felt it very embarrassing.
- 13 The actors suddenly had the (a laughter b chuckles c giggles d sniggers) in the middle of the performance.
- 14 In (a average b the whole c general d reality) women live longer than men in most countries.
- 15 There was a large notice in the hotel corridor saying '(a in case of b if c on account of d supposing) fire, press the alarm bell'.
- 16 People in Wales are (a most b predominantly c all in all d entire) Labour party supporters.
- 17 At the age of fifty, he finally admitted to himself that it was (a greatly b largely c highly d almost) unlikely that he was going to be a pop idol.
- 18 People try to make use of (a loopholes b shortages c gaps d clauses) in the law to pay less income tax.

## 56 Verb + noun combinations

Complete the phrases on the left with the most suitable verb. Choose from the words on the right. Use each verb once only.

- 1 To ..... an old building.
- 2 To ..... a fire, a light.
- 3 To ..... a crime, a mystery.
- 4 To ..... a story.
- 5 To ..... a birthday, a victory.
- 6 To ..... a crime, suicide.
- 7 To ..... a living.
- 8 To ..... a trap for someone, the table.
- 9 To ..... success.
- 10 To ..... a job, a work permit.
- 11 To ..... a promise, your leg, the ice.
- 12 To ..... a wish, an opinion.
- 13 To ..... attention, someone a compliment.
- 14 To ..... a meeting.
- 15 To ..... sight of someone, a bus.
- 16 To ..... your guilt.
- 17 To ..... a fortune, a title.
- 18 To ..... a prize, a medal.
- 19 To ..... a baby, a ship.
- 20 To ..... music.
- 21 To ..... a cheque, a document.
- 22 To ..... gear, your mind.
- 23 To ..... a criminal.
- 24 To ..... an accusation.
- 25 To ..... an accused person.

achieve
acquit
adjourn
apply for
arrest
award
break
catch
celebrate
change
christen
commit
compose
confess
demolish
deny
earn
express
extinguish
forge
inherit
investigate
lay
narrate
pay



# 57 Fill in the missing letters

In each of the following sentences, one word has several letters missing. Try to work out what the missing word is.

- 1 I've just read an a---d--- version of the novel *War and Peace*. It was only one hundred pages long.
- 2 The beach was d-s----. There wasn't a soul to be seen anywhere.
- 3 I can think of c-----s- reasons for not getting married. Take my husband, for one.
- 4 I could hardly hear him. His voice was so f--t.
- 5 This jacket has a d-t----- lining.
- 6 He gave us a very v---d account of his journey through Burma.
- 7 When the fire broke out, everyone left by the e-----y exits.
- 8 Everyone agreed. The vote was u----m---
- 9 Be careful. That vase is f-g---!
- 10 This sentence is a---g---. You'd better rewrite it so as to make it clearer.
- 11 It is c---m--- in Britain to tip waiters and taxi drivers.
- 12 Your parents are going to be f-r---- when they find out what has happened to the car.
- 13 Farmer Giles was a short, stocky man with a r---y complexion.
- 14 We could tell she wasn't pleased. She had a g-i- expression on her face.
- 15 Hundreds of people were made r----d--- when the factory closed down.
- 16 We couldn't open the door - it was j-m---
- 17 The p-----t chairman comes from New Zealand.
- 18 The victim was given a l----l dose of poison.
- 19 Al Capone was a n-----s gangster.
- 20 There should be a cure for AIDS in the not too d-----t future.

Write your answers here:

- |         |          |          |
|---------|----------|----------|
| 1 ..... | 8 .....  | 15 ..... |
| 2 ..... | 9 .....  | 16 ..... |
| 3 ..... | 10 ..... | 17 ..... |
| 4 ..... | 11 ..... | 18 ..... |
| 5 ..... | 12 ..... | 19 ..... |
| 6 ..... | 13 ..... | 20 ..... |
| 7 ..... | 14 ..... |          |

# 58 'Daft' definitions

Match the definitions (1-20) below with a suitable word (a-t) on the right. Write your answer in the boxes at the bottom of the page.

- 1 The heaviest thing you can carry.
- 2 A gown worn while sitting on the grass.
- 3 A period when we have to go without things our grandparents never heard of.
- 4 A broom with a stomach.
- 5 A sick bird of prey.
- 6 Something you can approve of and look down on at the same time.
- 7 Two untruths.
- 8 What a matador tries to do.
- 9 What the last runner in a race wants to do.
- 10 The ability to describe others as they see themselves.
- 11 Something that runs down more people than cars.
- 12 What you say when you are lost.
- 13 Where campers sleep.
- 14 A substance for making mountains out of molehills.
- 15 Quite good-looking.
- 16 What a hen does to an egg.
- 17 Two ivory cubes with dots all over them.
- 18 A plum that sunbathed too much.
- 19 What you do when it starts raining.
- 20 A confused chicken.

- |   |                |
|---|----------------|
| a | anthem         |
| b | avoidable      |
| c | bricklayer     |
| d | cleavage       |
| e | coincide       |
| f | gossip         |
| g | grudge         |
| h | hatchet        |
| i | illegal        |
| j | intense        |
| k | ketchup-       |
| l | laundress      |
| m | paradise       |
| n | paralyse       |
| o | prune          |
| p | recession      |
| q | silicone       |
| r | tact           |
| s | vacuum cleaner |
| t | warehouse      |

1	2	3	4	5	6	7	8	9	10	11	12	13	14	15	16	17	18	19	20	

# Answers

## TEST 1

bat	5
donkey	8
octopus	11
wolf	6
elk	7
fox	9
rhinoceros	12
hedgehog	2
reindeer	3
hippopotamus	1
squirrel	10
tortoise	4

## TEST 2

1 trip
2 voyage
3 run
4 flight
5 tour
6 travel
7 excursion
8 expedition
9 journey
10 cruise
11 package tour
12 outing

## TEST 3

1 (c) skylight
2 (a) use
3 (c) intention
4 (d) denied
5 (b) core
6 (d) spinster
7 (a) cat's eyes
8 (b) gap
9 (d) minutes
10 (e) head over heels
11 (a) paw
12 (b) faintest
13 (b) sprained

14 (c) advised
15 (c) vivid
16 (a) resumed
17 (c) peeling
18 (a) critically
19 (e) needles
20 (b) upset

## TEST 4

1 do him in
2 gone off
3 gave him away
4 goes back to
5 call on
6 cut up
7 getting me down
8 gone down with
9 look it up
10 get at
11 went out
12 getting on for
13 take away
14 gone down
15 took to
16 turned it down
17 look in
18 take off

## TEST 5

1 a versatile
2 a convivial
3 a magnanimous
4 a greedy
5 a gullible
6 a chauvinistic
7 an illiterate
8 a bilingual
9 an indefatigable
10 an erudite
11 a scintillating
12 a vivacious

## TEST 6

thigh bone	9
collarbone	3
kneecap	10
skull	1
shin bone (tibia)	12
wrist bones	8
breastbone	5
spine/backbone	2
shoulder blade	4
hipbone	7
fibula	11
rib	6

## TEST 7

1 prison
2 piano
3 newspaper
4 bed
5 golf
6 car
7 astrology
8 boxing
9 watch
10 roof
11 cat
12 camera
13 theatre
14 aeroplane
15 window
16 funeral
17 chess
18 castle
19 rugby
20 farm

## TEST 8

1 scenery
2 landscape
3 scene
4 country
5 highlands

6 countryside
7 rural
8 nature
9 bush
10 setting
11 environment
12 view

## TEST 9

1 disability
2 basically
3 artistic
4 unreasonable
5 actions
6 applicable
7 bloodshot
8 comparatively
9 confidential
10 continually
11 disobedience
12 classifying
13 indefensible
14 mistaken
15 imprisonment
16 partially
17 disqualified
18 widespread
19 precision
20 headstrong

## TEST 10

### Across

1 incredible
2 industrious
3 mean
4 considerate
5 rude
6 temporary
7 blunt
8 conceited
9 accidental
10 huge

### Down

1 irritated
2 transparent
3 obstinate
4 odd
5 scarce

6 compulsory
7 tiny
8 affluent
9 dependable
10 exciting

## TEST 11

1 recognised
2 gazed
3 caught a glimpse of
4 distinguish
5 Look at
6 glanced
7 peeped
8 glared
9 scrutinised
10 staring
11 eyed
12 peered
13 noticing
14 watch
15 catch his eye
16 observing

## TEST 12

1 company
2 tribe
3 board
4 suite
5 flock
6 bunch
7 litter
8 team
9 staff
10 crowd
11 herd
12 swarm
13 set
14 crew
15 pack
16 shoal
17 fleet
18 suit
19 bundle
20 flight

## TEST 13

nut	2
butter-dish	3
coal scuttle	12
sieve	5
box of tissues	10
bolt	1
rubbish-bin	9
washer	4
table-mat	6
chopper	11
draining-board	8
mantelpiece	7

## TEST 14

1 black and blue all over
2 got into hot water
3 hard up
4 at loggerheads
5 stuck up
6 dead beat
7 gave me the cold shoulder
8 make ends meet
9 was a bit out of sorts
10 flogging a dead horse
11 hit the roof
12 few and far between
13 get a move on
14 cats and dogs
15 It sticks out a mile

## TEST 15

1 in
2 at
3 in ... At
4 out of
5 in
6 on
7 on ... of
8 in
9 at ... of
10 in
11 at
12 in
13 in
14 by
15 by

- 16 in
- 17 for
- 18 for
- 19 by
- 20 in

**TEST 16**

- 1 Field Marshal
- 2 Secretary-General
- 3 producer
- 4 foreman
- 5 manager
- 6 headmaster/headmistress
- 7 abbot
- 8 captain
- 9 curator
- 10 governor
- 11 butler
- 12 Principal
- 13 chairperson
- 14 Vice-Chancellor
- 15 umpire
- 16 Prime Minister
- 17 chief/chieftain
- 18 Managing Director
- 19 Mother Superior
- 20 leader
- 21 warden
- 22 choirleader
- 23 President
- 24 editor
- 25 matron

**TEST 17**

- 1 binary
- 2 tricycle
- 3 century
- 4 soloist
- 5 bigamist
- 6 duet
- 7 pentagon
- 8 decade
- 9 biplane
- 10 fortnight
- 11 duel
- 12 monologue
- 13 ambidextrous
- 14 twins

- 15 centipede
- 16 binoculars
- 17 unicorn
- 18 quartet
- 19 coalition
- 20 triplets

**TEST 18**

- 1 crippled
- 2 altered
- 3 non-flammable
- 4 defective
- 5 blinked
- 6 comic
- 7 trained
- 8 electrical
- 9 childish
- 10 rumour
- 11 collaborate
- 12 Technical
- 13 specially
- 14 disinterested
- 15 nil
- 16 possibility
- 17 disused
- 18 counsellor
- 19 room
- 20 shade
- 21 possibly
- 22 umpire
- 23 policy
- 24 steps
- 25 barrister
- 26 write-up
- 27 financial
- 28 morale
- 29 convenient
- 30 amenities

**TEST 19**

- 1 (a) full up
- 2 (d) waste
- 3 (d) brand
- 4 (c) perjury
- 5 (b) keep
- 6 (a) left
- 7 (c) profit
- 8 (b) prevent
- 9 (d) estimated

- 10 (c) order
- 11 (e) short
- 12 (d) write-up
- 13 (b) clap
- 14 (c) tough
- 15 (a) else
- 16 (c) gossip
- 17 (b) plot
- 18 (a) fine
- 19 (b) leg
- 20 (c) hereditary

**TEST 20**

- 1 suggested
- 2 insisted
- 3 inquired
- 4 demanded
- 5 snapped
- 6 whispered
- 7 boasted
- 8 shouted
- 9 explained
- 10 pleaded
- 11 complained
- 12 stammered

**TEST 21**

- 1 go over
- 2 turn out
- 3 fallen out
- 4 turned away
- 5 taken for
- 6 put me up
- 7 come apart
- 8 let off
- 9 get out of
- 10 do up
- 11 puts up with
- 12 get through to
- 13 gone off
- 14 came round
- 15 goes with
- 16 go through with
- 17 puts me off
- 18 get round to

**TEST 22**

- 1st Spitting Image
- 2nd Willy What
- 3rd Red Rum

**TEST 23**

- 1 sixth
- 2 serve
- 3 weary
- 4 lanky
- 5 carrot
- 6 orange
- 7 water
- 8 delay
- 9 death
- 10 core
- 11 recipe
- 12 dreary
- 13 income
- 14 happy
- 15 crowd
- 16 often
- 17 shawl
- 18 stand
- 19 brandy
- 20 rugby
- 21 Sweden
- 22 carpet
- 23 sheet
- 24 stapler
- 25 polite

**TEST 24**

- 1 commit
- 2 burglary
- 3 sentenced ... imprisonment
- 4 verdict
- 5 proof
- 6 fine
- 7 arson
- 8 shoplifting
- 9 arrested ... charged
- 10 Magistrate's Court ... Crown Court
- 11 juvenile delinquent
- 12 witness
- 13 solicitor ... barrister

- 14 bail
- 15 embezzlement
- 16 evidence
- 17 testimony
- 18 remanded in custody
- 19 probation
- 20 defence ... prosecution

**TEST 25**

**Across**

- 1 plate rack
- 2 trolley
- 3 window sill
- 4 scrubbing brush
- 5 radiator
- 6 mincer
- 7 coffee table
- 8 rolling pin
- 9 standard lamp
- 10 fan

**Down**

- 1 stapler
- 2 roller blind
- 3 washbasin
- 4 dishwasher
- 5 fuse
- 6 bucket
- 7 venetian blind
- 8 tea towel
- 9 grater
- 10 ladle

**TEST 26**

- 1 seasons
- 2 containers
- 3 shapes
- 4 fasteners
- 5 timbers
- 6 game
- 7 beverages
- 8 handicrafts
- 9 conjunctions
- 10 dwellings
- 11 fractions
- 12 suits
- 13 alloys
- 14 sciences
- 15 abbreviations

- 16 gems
- 17 gases
- 18 minerals
- 19 timepieces
- 20 dishes

**TEST 27**

- 1 score
- 2 scare
- 3 scale
- 4 whale
- 5 while
- 6 smile
- 7 smell
- 8 spell
- 9 spoil
- 10 Spain
- 11 train
- 12 grain
- 13 grape
- 14 graze
- 15 erase

**TEST 28**

**American English**

- 1 bill
- 2 smokestack
- 3 monkey wrench
- 4 purse
- 5 flashlight
- 6 Scotch tape
- 7 yard
- 8 undershirt
- 9 tag
- 10 wire
- 11 street musician
- 12 streetlight
- 13 blow-out
- 14 trailer
- 15 mortician
- 16 fire department
- 17 sideburns
- 18 baby carriage
- 19 sucker
- 20 vacation

**British English**

- 1 bank note
- 2 chimney



- 3 spanner
- 4 handbag
- 5 torch
- 6 sellotape
- 7 garden
- 8 vest
- 9 label
- 10 telegram
- 11 busker
- 12 lamppost
- 13 puncture
- 14 caravan
- 15 undertaker
- 16 fire brigade
- 17 sideboards
- 18 pram
- 19 lollipop
- 20 holiday

**TEST 29**

- 1 strode
- 2 marched
- 3 plodded
- 4 stumbled
- 5 scampered
- 6 loitered
- 7 staggered
- 8 skipped
- 9 tramped
- 10 strolled
- 11 limped
- 12 crept

**TEST 30**

- duster 3
- flex 11
- toast rack 5
- slide rule 6
- headboard 1
- pressure cooker 12
- continental quilt 7
- wrench 2
- brace 9
- bit 10
- flannel 4
- skirting board 8

**TEST 31**

- 1 on
- 2 in ... at
- 3 by
- 4 in ... with/out of
- 5 in ... for
- 6 in ... of
- 7 in ... of
- 8 on
- 9 on
- 10 in ... of
- 11 by
- 12 from ... to
- 13 in ... of
- 14 on
- 15 on
- 16 in
- 17 on ... with
- 18 in
- 19 for
- 20 on ... of

**TEST 32**

- 1 gets my goat
- 2 out of the blue
- 3 call it a day
- 4 like a bear with a sore head
- 5 rings a bell
- 6 I haven't a clue
- 7 on the house
- 8 talking shop
- 9 given the sack
- 10 for donkey's years
- 11 given a good hiding
- 12 I can't make head or tail of it
- 13 keep it quiet
- 14 put your foot in it
- 15 pull your socks up

**TEST 33**

- the beat of the drum
- the blast of an explosion
- the ring of a telephone
- the chime of a clock
- the clanking of chains
- the crack of a whip

- the wail of a siren
- the howling of the wind
- the murmur of a stream
- the pealing of bells
- the report of a rifle
- the screeching of brakes

**TEST 34**

- 1 adore
- 2 swindle
- 3 adamant
- 4 zealous
- 5 undertake
- 6 artful
- 7 decree
- 8 entreat
- 9 affluent
- 10 abhor
- 11 valiant
- 12 conceited
- 13 bewildered
- 14 entirety
- 15 outcome
- 16 impotent
- 17 district
- 18 corpulent
- 19 exodus
- 20 slaughter

**TEST 35**

- anchor 3
- sling 8
- clip 6
- chain 13
- stitch 12
- joint 1
- bolt 9
- harness 5
- handcuffs 11
- cable 2
- tacks 10
- zip 4
- rivet 7

**TEST 36**

- 1 a camera
- 2 a window
- 3 a roof

- 4 an orange
- 5 a bottle
- 6 a needle
- 7 a flower
- 8 a fork
- 9 a typewriter
- 10 a chess set
- 11 a branch
- 12 a bird
- 13 a jacket
- 14 a chair
- 15 a knife
- 16 a book
- 17 a chimney
- 18 a rifle
- 19 a dress
- 20 a shoe

**TEST 37**

- 1 family doctor ... surgery
- 2 prescription
- 3 Maternity Ward
- 4 scald
- 5 infectious ... contagious
- 6 Hay fever
- 7 midwife
- 8 mumps
- 9 indigestion
- 10 antiseptic
- 11 measles
- 12 insomnia
- 13 constipated
- 14 crutches
- 15 X-ray
- 16 surgeon
- 17 sedative
- 18 general anaesthetic
- 19 matron

**TEST 38**

- Suggested answers (others may be possible):
- 1 Could (can) I speak to John, please?
  - d I'm sorry, but there's no one called John living here. You must

- have got the wrong number.
- 2 Would you like a cigarette? (Do you smoke?)

- 1 No, thanks. I've given it up.
- 3 What's the time, please?
- f Er ... almost three.
- 4 Excuse me, can you tell me the way to (how to get to) Station Road, please?
- h I'm sorry, I'm a stranger here, too.
- 5 Would you like me to carry your suitcase? (Shall I carry your suitcase?)
- e No, it's all right, thank you. I can manage.
- 6 Where are you going for your holidays (this year/summer)?
- j Well, we were thinking of going to Poland for a change. It was so crowded last year in Spain.
- 7 I'm not late am I? (I do hope I'm not late.)
- b No, of course not. I've only just arrived myself.
- 8 Would you like a (another) drink?
- a No, I'd better not, thanks, I'm driving.
- 9 Did you have a good flight/journey
- g Not too bad, thanks. But I don't really like flying.
- 10 What's the date?/Do you know what the date is?/ What's today's date?/ What's the date today?
- k Er ... It's the 5th I think.

- 11 Do you take sugar?
- i Yes, two lumps, please.
- 12 Will you marry me?
- c I can't I'm afraid. I'm already married.

**TEST 39**

- 1 a hatter
- 2 a pancake
- 3 a doornail
- 4 lead
- 5 a feather
- 6 clockwork
- 7 a bat
- 8 chalk from cheese
- 9 a bell
- 10 the nose on your face
- 11 two peas in a pod
- 12 a fox
- 13 nails
- 14 a bee
- 15 mustard
- 16 a church mouse
- 17 a rock
- 18 a post
- 19 a fiddle
- 20 a picture
- 21 brass
- 22 a lord
- 23 a cucumber
- 24 toast
- 25 the hills
- 26 a daisy
- 27 life
- 28 the grave
- 29 gold
- 30 a berry

**TEST 40**

- Make**
- a journey
  - progress
  - a speech
  - a will
  - a mistake
  - fun of someone
  - a complaint
  - arrangements
  - a bargain

the beds  
 a fuss  
 a nuisance of oneself  
 an effort  
 an impression  
 a profit

**Do**  
 business  
 harm  
 one's best  
 the garden  
 a good job  
 the shopping  
 a favour  
 the washing-up  
 repairs  
 one's duty  
 someone a good turn  
 an exercise  
 one's hair  
 homework  
 an examination

**TEST 41**

- 1 actor
- 2 secretary
- 3 dentist
- 4 artist
- 5 doctor
- 6 plumber
- 7 bricklayer
- 8 teacher
- 9 farmer
- 10 priest
- 11 electrician
- 12 carpenter
- 13 dressmaker
- 14 photographer
- 15 writer
- 16 postman
- 17 chemist
- 18 policeman
- 19 fireman
- 20 nurse

**TEST 42**

Cartoon	Correct caption
1	8
2	7
3	6
4	5
5	10
6	4
7	9
8	3
9	1
10	2

**TEST 43**

roundabout	7
knitting needle	10
nappy	13
roof tiles	4
scaffolding	9
kerb	11
firework	15
music stand	18
skipping rope	1
telegraph pole	19
parting	16
drain	12
pawn	6
skylight	5
udder	17
gutter	3
crutches	20
cuff	14
straw	8
plimsoll	2

**TEST 44**

Across	
1	loss
2	sour
3	entrance
4	cowardly
5	brag
6	reward
7	deteriorate
8	tenant
9	particularly
10	permit
11	useless

**Down**

- 1 obtain
- 2 conceal
- 3 deny
- 4 row
- 5 error
- 6 detest
- 7 barren
- 8 keen
- 9 mischievous
- 10 vanish
- 11 criticise
- 12 remedy
- 13 reject

**TEST 45**

- 1 attack
- 2 wink
- 3 pinch
- 4 stroke
- 5 speck
- 6 spell
- 7 whiff
- 8 stretch
- 9 flash ... clap
- 10 breath
- 11 plot
- 12 shock
- 13 gust
- 14 hint

**TEST 46**

Misprint	Correct word
1 car	cat
2 brides	bribes
3 sweat	sweet
4 considerable	considerate
5 antidotes	anecdotes
6 Satan	Satin
7 cating	beating
8 conversation	conservation
9 detergent	deterrent
10 Window	Widow
11 insulted	insulated
12 sins	sings
13 deserts	desserts
14 pec	see
15 suites	suits
16 mouse	house

- |            |          |
|------------|----------|
| 17 killed  | skilled  |
| 18 Capital | Corporal |
| 19 moving  | mowing   |
| 20 peach   | peace    |
| 21 guests  | gusts    |
| 22 scraped | scrapped |
| 23 wood    | food     |
| 24 welding | wedding  |
| 25 rats    | rates    |

**TEST 47**

- 1 blowing his own trumpet
- 2 let the cat out of the bag
- 3 get butterflies in my stomach
- 4 to keep a straight face
- 5 down the drain
- 6 hold my tongue
- 7 He wouldn't say 'Boo' to a goose
- 8 pulling my leg
- 9 chesed off
- 10 an out-and-out
- 11 for a song
- 12 pig-headed
- 13 as right as rain
- 14 get on like a house on fire
- 15 smell a rat

**TEST 48**

- 1 furious
- 2 weary
- 3 giddy
- 4 stiff
- 5 unconscious
- 6 peckish
- 7 upset
- 8 homesick
- 9 thrilled
- 10 preoccupied
- 11 hoarse
- 12 terrified
- 13 sympathetic
- 14 embarrassed
- 15 winded
- 16 pregnant

- 17 dejected
- 18 depressed
- 19 faint
- 20 nostalgic
- 21 relieved
- 22 drowsy
- 23 disappointed
- 24 disgusted
- 25 offended
- 26 amazed
- 27 listless
- 28 despondent
- 29 tense
- 30 sober

**TEST 49**

- 1 defect
- 2 depressed
- 3 debate
- 4 decrease
- 5 deal
- 6 deficient
- 7 demolish
- 8 dependable
- 9 demand
- 10 delicious
- 11 detective
- 12 deadline
- 13 democracy
- 14 detergent
- 15 deckchair
- 16 deodorant
- 17 defeat
- 18 deliberate
- 19 detest
- 20 desert

**TEST 50**

- 1 Right (often people's dead pets).
- 2 Wrong (it should be inferred; to imply means to suggest indirectly, e.g. his failure to return my phone call seems to imply a lack of interest).
- 3 Right (the person who has the job after you is

- your successor).
- 4 Right (a copywriter writes the words used in advertisements).
  - 5 Wrong (it should be distasteful; tasteless is to do with food).
  - 6 Right.
  - 7 Wrong (vulpine relates to foxes; lupine relates to wolves).
  - 8 Right (he or she learns another actor's part and takes over if they are ill or cannot perform for any other reason).
  - 9 Wrong (something that is fragile is easy to break or damage, e.g. a glass vase; something with a sweet and pleasant smell is fragrant).
  - 10 Wrong (he or she is an evil person who wishes to hurt others).
  - 11 Wrong (it means to warn them severely that they have done something wrong).
  - 12 Right.
  - 13 Right.
  - 14 Wrong (it should be furious; to fumigate means to disinfect or purify by means of smoke).
  - 15 Right.
  - 16 Right.
  - 17 Wrong (he's probably a marquis, a type of nobleman; a marquee is a very large tent for outdoor events).
  - 18 Right (a prolific writer, artist or composer produces a very large number of works).
  - 19 Wrong (fatuous has nothing to do with being fat; fatuous

people are very silly and stupid).

- 20 Wrong (something that is inflammable burns easily; something that doesn't burn is non-flammable).

#### TEST 51

- 1 Miss D. Buss (missed the bus)
- 2 Watt C. Dunne (What's he done?)
- 3 I. Malone (I'm alone)
- 4 Egon Chips (egg on chips)
- 5 I. C. Waters (icy waters)
- 6 Annie Versary (anniversary)
- 7 G. Howard Hertz (Gee! How it hurts)
- 8 Dinah Mite (dynamite)
- 9 Eileen Dover (I leaned over)
- 10 Robin Banks (robbing banks)
- 11 Sandy Shaw (sandy shore)
- 12 Lotta Kidz (lot of kids)
- 13 Sue Nora Later (sooner or later)
- 14 Percy Vere (persevere)
- 15 Anne O'Rack (anorak)
- 16 Ivor Headache (I've a headache)
- 17 Justin Case (just in case)
- 18 Roland Coffey (roll and coffee)
- 19 R. Snick (arsenic)
- 20 Vic Tree (victory)

#### TEST 52

#### ANGER

cross, furious, irate, livid, mad

#### FATIGUE

exhausted, shattered, tired, weary, worn-out

#### FEAR

apprehensive, frightened, petrified, scared, terrified

#### SADNESS

depressed, downhearted, gloomy, miserable, unhappy

#### JOY/HAPPINESS

cheerful, elated, glad, joyful, thrilled

#### WARMTH/

#### FRIENDLINESS

affectionate, hospitable, neighbourly, sociable, sympathetic

#### TEST 53

- 1 bright
- 2 complete
- 3 roomy
- 4 loft
- 5 foe
- 6 greed
- 7 slay
- 8 abbreviate
- 9 comprehend
- 10 commence
- 11 expire
- 12 occur
- 13 roam
- 14 ancient
- 15 immense
- 16 shy
- 17 cite
- 18 despair
- 19 achieve
- 20 rely

#### TEST 54

- 1 advance
- 2 faint
- 3 private
- 4 grave
- 5 brow
- 6 admit
- 7 tug

8 bolt

9 swede

10 sty

11 tank

12 cricket

13 bass

14 cape

15 file

16 hide

17 shed

18 temple

19 vessel

20 bill

#### TEST 55

- 1 b grazed
- 2 a embezzling
- 3 d make out
- 4 b tapped
- 5 d chipped
- 6 a hard
- 7 b runny
- 8 d engrossed
- 9 c pushed
- 10 a Refreshments
- 11 d coincidence
- 12 d scenes
- 13 c giggles
- 14 c general
- 15 a in case of
- 16 b predominantly
- 17 c highly
- 18 a loopholes

#### TEST 56

- 1 demolish
- 2 extinguish
- 3 investigate
- 4 narrate
- 5 celebrate
- 6 commit
- 7 earn
- 8 lay
- 9 achieve
- 10 apply for
- 11 break
- 12 express
- 13 pay
- 14 adjourn

15 catch

16 confess

17 inherit

18 award

19 christen

20 compose

21 forge

22 change

23 acquit

24 deny

25 arrest

#### TEST 57

- 1 abridged
- 2 deserted
- 3 countless
- 4 faint
- 5 detachable
- 6 vivid
- 7 emergency
- 8 unanimous
- 9 fragile
- 10 ambiguous
- 11 customary
- 12 furious
- 13 ruddy
- 14 grim
- 15 redundant
- 16 jammed
- 17 present
- 18 lethal
- 19 notorious
- 20 distant

#### TEST 58

- 1 g
- 2 l (lawn dress)
- 3 p
- 4 s
- 5 i (ill eagle)
- 6 d
- 7 n (pair of lies)
- 8 b (avoid a bull)
- 9 k (catch up)
- 10 r
- 11 f
- 12 t (where house?)
- 13 j (in tents)
- 14 q

15 a (handsome said with a lisp)

16 h (hatch it)

17 m (pair of dice)

18 o

19 c (go inside)

20 c