

SLAMf Series

Thermal Mass Flow



Model SLAMf

Elastomer Sealed, Digital, Thermal Mass Flow Meters and Controllers

Overview

The SLA Series mass flow meters and mass flow controllers have gained broad acceptance as the standard for accuracy, stability and reliability. These products have a wide flow measurement range and are suitable for a broad range of temperature and pressure conditions making them well suited for applications in chemical and petrochemical research, laboratory, analytical, fuel cell, life science among others.

Highlights of the SLAMf Series mass flow product include: industry leading long term stability, accuracy backed by superior metrology systems and methods using primary calibration systems directly traceable to international standards and a broad range of analog and digital I/O options to suit virtually any application. An independent diagnostic/service port permits users to troubleshoot or change flow conditions without removing the mass flow controller from service. The SLAMf Series products have NEMA 4X and IP66 weatherproof protection enclosures for 'Hosedown' applications such as; Food, Beverage, Pilot Plants, Pharmaceutical and Biotech.

Product Description

The SLAMf Series provides a highly configurable platform based on a simple modular architecture. The SLAMf Series feature set was carefully selected to enable drop-in replacement and upgrade of many brands of mass flow controllers. With the wide range of options and features available, the SLAMf Series provides users with a single platform to support a broad range of applications.

Features and Benefits

Features	Benefits
Industry leading sensor stability	Increased system throughput and reduced cost of ownership by reducing maintenance and eliminating periodic recipe adjustments and/or recalibrations
User accessible service port	Simplified installation, start-up, troubleshooting and access to diagnostics provides maximum uptime
Advanced diagnostics	Ensures device is operating within user specified limits for high process yield and maximum uptime
Superior valve technology	Minimum leak-by, maximum turndown, and fast response reduces overall gas panel cost and increases throughput
Adaptable mechanical configurations	Easily retrofit to existing systems
Primary standard calibration systems	Ensures measurement accuracy is traceable to international standards
Simple modular design	Easy-to-service elastomer sealed design provides for factory or field service maximizing uptime and reducing total cost of ownership

Product Description

Advanced Thermal Flow Measurement Sensor

Brooks' sensor technology combines:

- Excellent signal to noise performance for improved accuracy at low setpoints
- Superior long-term stability through enhanced sensor manufacturing and burn in process
- Isothermal packaging to reduce sensitivity to external temperature changes
- Corrosion resistant sensor flow path

Advanced Diagnostics

The mass flow controller remains the most complex and critical component in gas delivery systems. When dealing with highly toxic or corrosive gases, removing the mass flow controller to determine if it is faulty should be the last resort. In response to this, Brooks pioneered smarter mass flow controllers with embedded self test routines and introduced an independent diagnostic/service port to provide the user with a simple interface, for troubleshooting without disturbing flow controller operation.

Wash-down Enclosure

The SLAMf Series comes equipped with an IP66 / NEMA4X rated enclosure. This makes these instruments perfect for wash-down or outdoor environments. So no matter how harsh the surroundings, the SLAMf Series keeps the process under control.

Wide Flow Range

The SLAMf Series covers an extremely broad range of flow rates. Model SLAMf50 can have a full scale flow as low as 3 ccm. With a high turndown ratio of 100:1 for any full scale range from 1-50 lpm N₂ equivalent and 50:1 turndown for all other flow rates, accurate gas flow can be measured or controlled down to 0.06 ccm! Model SLAMf53 can monitor or control gas flows up to 2500 lpm

Fast Response Performance

The all-digital electronics and superior mechanical configuration in the SLAMf Series provide for ultra fast response characteristics.

Broad Array of Communication Options

Brooks offers traditional 0-5 volt and 4-20mA analog options as well as RS485 digital communications ("S-protocol", based on HART) Brooks also offers control interfaces via digital network protocols like DeviceNet, a high speed (up to 500k baud) digital communication network, and Profibus. Brooks' communication capabilities and device-profiles have been certified by the ODVA (Open DeviceNet Vendor's Association) and the ITK (Interoperability Test Kit). Other network protocols are in development. Talk to your Brooks representative about your specific needs.

Industrial Multi-gas/Multi-range Capabilities

The SLAMf allows multi-gas and multi-range capabilities to reduce customer inventory. Storage and pre-programming of up to 6 gas calibrations easily permits users to switch between different gasses and ranges on a single device.

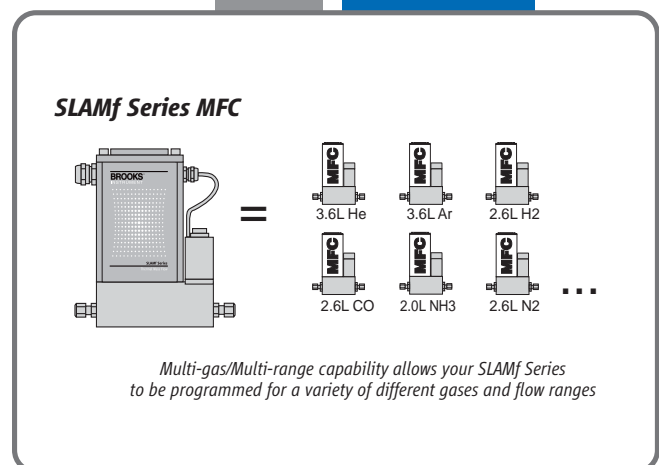
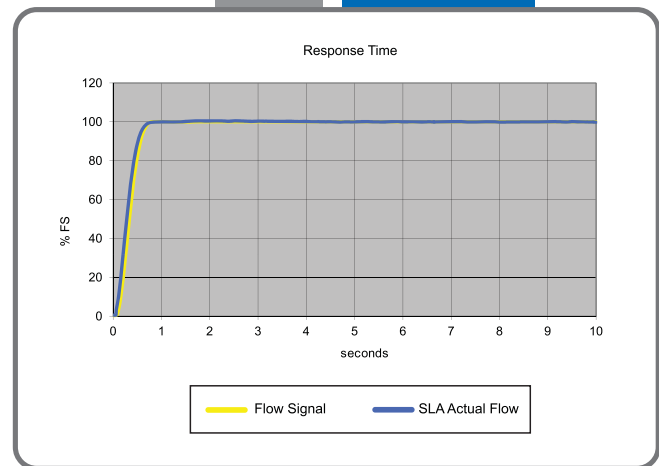
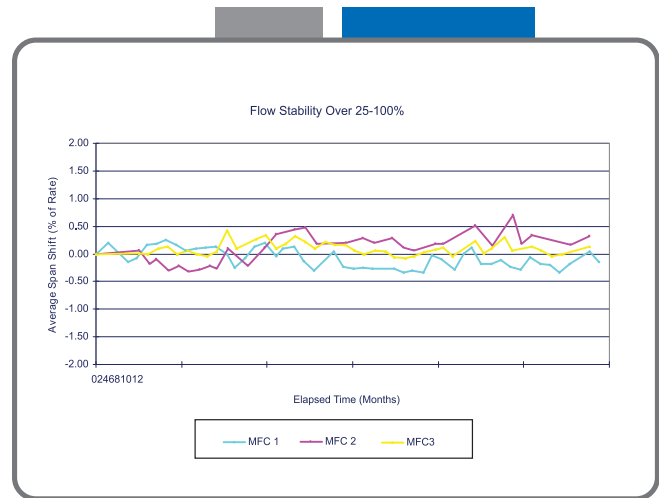

Product Applications

Bioreactors

Brooks has earned a leading reputation in controlling of gas flows for bioreactor applications.

For applications where dissolved oxygen and pH control are more critical, mass flow controllers provide the next level of precision and automation. Brooks offers a wide range of solutions including multiple gas calibrations on the SLAMf. With optional digital communication protocols, NEMA 4X/IP66 enclosures to prevent dust/moisture from getting in, and other features offered by the SLAMf, it is ideally suited for bioreactors.

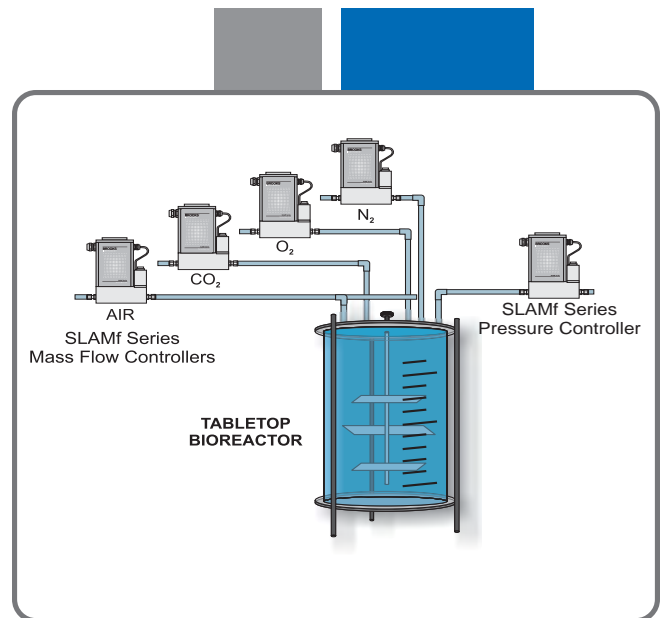

Petrochemical Pilot Plants

When designing new petrochemical pilot plants, customers not only need a product that is repeatable, accurate, and resistant to long term sensor drift, they also need products that can withstand hazardous areas and conditions.

Brooks' SLAMf is Class 1, Div 2 area classified, making them suitable for environments that contain a large number of flammable gases. It is also safe to use for outdoor environments due to the NEMA 4X/IP66 enclosure, which prevents weather and harsh elements from damaging the mass flow controller.

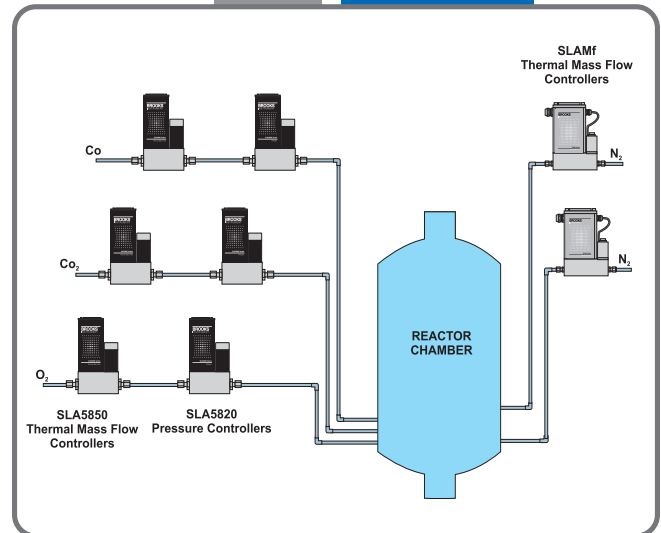

Blanketing in Food Processing

Brooks has continuously challenged itself to provide our customers with solutions that provide superior results. This approach has even applied to the food processing industry.

For making fruit filled yogurt, fruit filling is held in holding tanks until it is needed. During production the tank is emptied into blend tanks and then sent to a fill line until the tank is empty. The production area is cleaned using a warm wash down, while the tank is cleaned using steam sterilization. The tank is then backfilled with high purity air to prevent contamination.

The SLAMf is the perfect product for this application. The NEMA 4X enclosure prevents unwanted moisture, caused by the wet environment, from contaminating the high purity air flowing through the MFC. In addition, a SolidSense II pressure transducer is also used to control the head pressure in the tank. The SLAMf can adjust the air flow to the tank based off the signals sent by the SolidSense II pressure transducer.

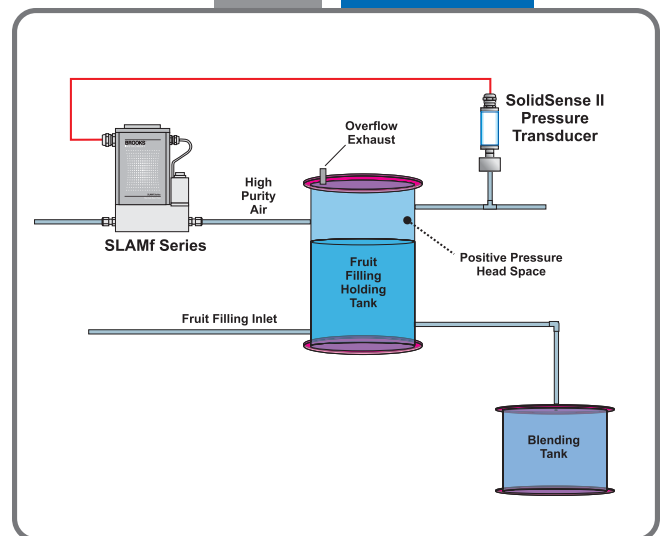

Product Specifications

Flow Ranges and Pressure Ratings:

Mass Flow Controller Model	Mass Flow Meter Model	Flow Ranges N2 Eq. Ratings		Pressure Unit psi/bar		PED Module H Category
		Min. F.S.	Max. F.S.	Standard	Optional	
SLAMf50	SLAMf60	0.003	50 lpm	1500 psi/100 bar	4500 psi/310 bar	SEP
SLAMf51	SLAMf61	15	100 lpm*	1500 psi/100 bar	NA**	SEP
SLAMf53	SLAMf63	100	2500 lpm	1000 psi/70 bar	NA	1 for all 150 lb flanges 2 for all other connections

* 200 lpm of H2 possible, 600 lpm of H2 possible with decreased accuracy

** 4500 psi/310 bar available as a special on the SLAMf61 only

Performance

	SLAMf50/60	SLAMf51/61	SLAMf53/63
Flow Accuracy	±0.9% of S.P. (20-100% F.S.), ±0.18% of F.S. (2-20% F.S., 1-20% F.S. from 1-50 lpm)		±0.9% of S.P. (20-100% F.S.), ±0.18% of F.S. (2-20% F.S.) up to 1100 lpm ±1.0% of F.S. from 1100 lpm up to 2500 lpm
Control Range	Turndown 100:1 for F.S. from 1-50 lpm (50:1 for all other F.S. flows)		
Repeatability & Reproducibility	0.20% S.P.		
Linearity	Included in accuracy		
Response Time (Settling Time within ±2% F.S. for 0-100% command step)*	< 1 second		< 3 seconds
Zero Stability	< ± 0.2% F.S. per year		
Temperature Coefficient	Zero: <0.05% of F.S. per °C. Span: < 0.1% of S.P. per °C		
Pressure Coefficient	±0.03% per psi (0-200 psi N2)		
Attitude Sensitivity	<0.2% F.S. maximum deviation from specified accuracy after re-zeroing		

Ratings

Operating Temperature Range	0-65°C (32-149°F)		
Minimum Pressure Differential (Controllers)	5 psi/0.35 bar	10 psi/0.69 bar	Min.: 7.5 psi/0.52 bar at 500 lpm Min.: 14.5 psi/1.00 bar at 1000 lpm Min.: 35.0 psi/2.41 bar at 2500 lpm
Maximum Pressure Differential (Controllers)	Application specific up to 1500 psi/103.4 bar	50 psi/3.45 bar	300 psi/20.0 bar
Leak Integrity (external)	1x10 ⁻⁹ atm. cc/sec He		

Mechanical

Valve Type	Normally Closed, Normally Open, Meter
Primary Wetted Materials	316L Stainless Steel, High Alloy Stainless Steel, Viton® fluoroelastomers, Buna-N, Kalrez®, Teflon®/Kalrez®, and EPDM





* Response time can be improved upon request

Diagnostics

Status Lights	MFC Health, Network Status
Alarms*	Sensor Output, Control Valve Output, Over Temperature, Power Surge/Sag, Network Interruption
Diagnostic/Service Port	RS485 via 2.5mm jack (Located under the top cover)

* Alarm modes are dependent on the communications interface. These are described in the corresponding digital communication interface manual.

Certifications

Mark	Agency	Certification	Applicable Standard	Status
	CE	EMC Directive 2004/108/EC	EN:61326-1:2006	Pass
	UL (Listed)	Class I, Div 2, Group A, B, C, D Class II, Div 2, Group F, G & Class III	CSA C22.2 NO. 213-M1987 ISA 12.12.01	Pending
	UL (Recognized)	Class I, Div 2, Group A, B, C, D	CSA C22.2 NO. 213-M1987 ISA 12.12.01	Pending
	ATEX	II 3 G Ex nA IIC T4 Gc II 3 D Ex ic IIIC T85°C Db	EN 60079-0:2012, EN 60079-15:2010, EN 60079-31:2009	Pending
	IECEX	II 3 G Ex nA IIC T4 Gc II 3 D Ex ic IIIC T85 °C Db	IEC 60079-0:2011, IEC 60079-15:2010, EN 60079-31:2008	Pending

Electrical Specifications

Communication Protocol	RS485	Profibus®	DeviceNet™
Electrical Connection	All: PG11 Cable Gland, 1/2" NPT (F) Conduit, M20 x 1.5 Conduit DeviceNet Only: 5-Pin Micro Connector		
Analog I/O	0-5 V, 1-5 V, 0-10 V, 0-20 mA, 4-20 mA		N/A
Power Max./Purge	From +13.5 Vdc to +27 Vdc		From +11 Vdc to +25 Vdc
Power Requirements Watts, Max.	Valve Orifice > 0.032": 8 W Valve Orifice ≤ 0.032": 5 W Without Valve: 2 W		Valve Orifice > 0.032": 10 W Valve Orifice ≤ 0.032": 7 W Without Valve: 4 W

Voltage Set Point Input Specifications

Nominal Range	0-5 Vdc, 1-5 Vdc or 0-10 Vdc	N/A
Full Range	(-0.5)-11 Vdc	N/A
Absolute Max.	18 V (without damage)	N/A
Input Impedence	>990 kOhms	N/A
Required Max. Sink Current	0.002 mA	N/A

Current Set Point Input Specifications

Nominal Range	4-20 mA or 0-20 mA	N/A
Full Range	0-22 mA	N/A
Absolute Max.	24 mA (without damage)	N/A
Input Impedence	100 Ohms	N/A

Flow Output (Voltage) Specifications

Nominal Range	0-5 Vdc, 1-5 Vdc or 0-10 Vdc	N/A
Full Range	(-1)-11 Vdc	N/A
Min Load Resistance	2 kOhms	N/A

Flow Output (Current) Specifications

Nominal Range	0-20 mA or 4-20 mA	N/A
Full Range	0-22 mA (@ 0-20 mA); 3.8-22 mA (@ 4-20 mA)	N/A
Max. Load	380 Ohms (for supply voltage: < 16 Vdc) 580 Ohms (for supply voltage: ≥ 16 Vdc)	N/A

Analog I/O Alarm Output*

Type	Open Collector	N/A
Max. Closed (On) Current	25 mA	N/A
Max. Open (Off) Leakage	1µA	N/A
Max. Open (Off) Voltage	30 Vdc	N/A

Analog I/O Valve Override Signal Specifications**

Floating/Unconnected	Instrument controls valve to command set point	N/A
VOR < 0.3 Vdc	Valve Closed	N/A
1 Vdc < VOR < 4 Vdc	Valve Normal	N/A
VOR > 4.8 Vdc	Valve Open	N/A
Input Impedence	800 kOhms	N/A
Absolute Max. Input	(-25 Vdc) < VOR < 25 Vdc (without damage)	N/A

*The Alarm Output is an open collector or "contact type" that is CLOSED (on) whenever an alarm is active.

The Alarm Output may be set to indicate any one of various alarm conditions.

** The Valve Override Signal (VOR) is implemented as an analog input which measures the voltage at the input and controls the valve based upon the measured reading as shown in this section.

Product Dimensions

SLAMf50, Analog/RS485

MM/1 INCH

CABLE CONNECTOR	"W" DIMENSION
CABLE GLAND 0.20 (5.1) TO 0.39 (9.9) DIA. CABLE	28.6 [1,12]
1/2" NPT-F CONDUIT	16.5 [0,65]
M20x1.5 (F) CONDUIT	12.5 [0,49]

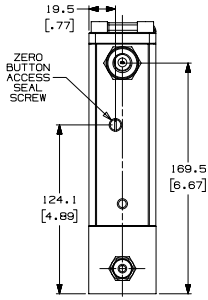

FITTING	"X" DIMENSION
1/8" TUBE COMP.	**180.7 [7,12]
1/4" TUBE COMP.	**185.3 [7,30]
3/8" TUBE COMP.	**188.4 [7,42]
1/2" TUBE COMP.	**192.4 [7,58]
1/4" VCR	181.8 [7,16]
1/4" VCO	173.6 [6,84]
1/4" NPT-F	176.2 [6,94]
6mm TUBE COMP.	**185.4 [7,30]
10mm TUBE COMP.	**188.8 [7,43]
3/8"-1/2" VCR	189.4 [7,46]
3/8"-1/2" VCO	184.8 [7,28]
1/4" RC-F (BSP)	174.2 [6,86]

* OVERALL LENGTH FINGER TIGHT

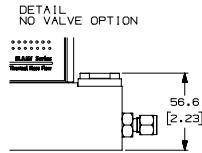
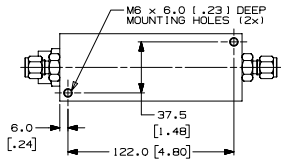
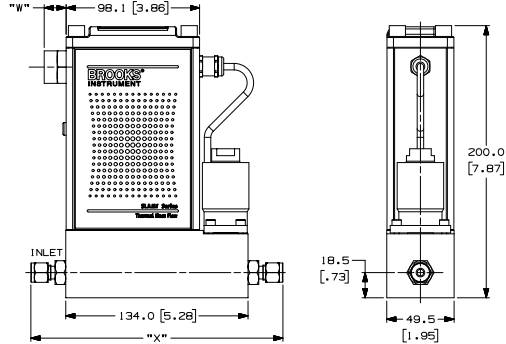
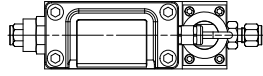

TOP VIEW SHOWN WITH COVER REMOVED

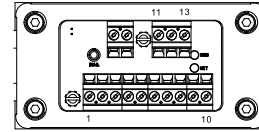

TERMINAL	FUNCTION
1	SETPOINT COMMON
2	FLOW OUTPUT (0-5V, 1-5V)
3	ALARM OUT
4	FLOW OUTPUT (0-20mA, 4-20mA)
5	POWER SUPPLY (13.3-27V)
6	SETPOINT INPUT (0-20mA, 4-20mA)
7	SETPOINT INPUT (0-5V, 1-5V)
8	POWER COMMON
9	FLOW OUT COMMON
10	VALVE OVERRIDE INPUT
11	AUX INPUT (0-5V, 0-10V)
12	RS-485, B (-), INPUT/OUTPUT
13	RS-485, A (+), INPUT/OUTPUT

SLAMf60, Analog/RS485

MM/1 INCH

CABLE CONNECTOR	"W" DIMENSION
CABLE GLAND 0.20 (5.1) TO 0.39 (9.9) DIA. CABLE	28.6 [1,12]
1/2" NPT-F CONDUIT	16.5 [0,65]
M20x1.5 (F) CONDUIT	12.5 [0,49]

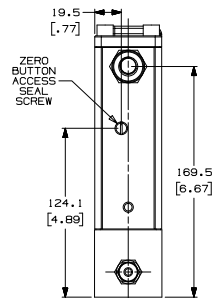

FITTING	"X" DIMENSION
1/8" TUBE COMP.	**145.3 [5,72]
1/4" TUBE COMP.	**149.9 [5,90]
3/8" TUBE COMP.	**152.9 [6,02]
1/2" TUBE COMP.	**157.0 [6,18]
1/4" VCR	146.3 [5,76]
1/4" VCO	138.2 [5,44]
1/4" NPT-F	140.7 [5,54]
6mm TUBE COMP.	**149.9 [5,90]
10mm TUBE COMP.	**153.2 [6,03]
3/8"-1/2" VCR	153.9 [6,06]
3/8"-1/2" VCO	149.4 [5,88]
1/4" RC-F (BSP)	138.8 [5,46]

* OVERALL LENGTH FINGER TIGHT

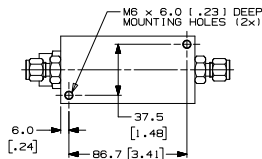
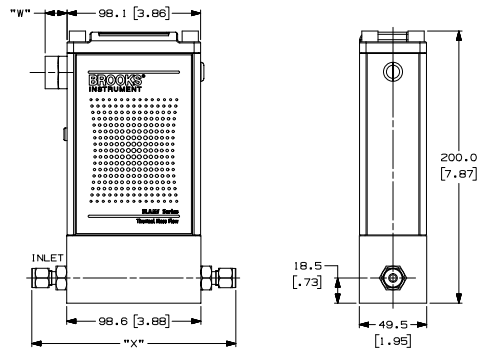
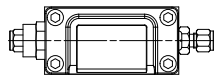

TOP VIEW SHOWN WITH COVER REMOVED

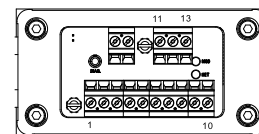

TERMINAL	FUNCTION
1	SETPOINT COMMON
2	FLOW OUTPUT (0-5V, 1-5V)
3	ALARM OUT
4	FLOW OUTPUT (0-20mA, 4-20mA)
5	POWER SUPPLY (13.3-27V)
6	SETPOINT INPUT (0-20mA, 4-20mA)
7	SETPOINT INPUT (0-5V, 1-5V)
8	POWER COMMON
9	FLOW OUT COMMON
10	VALVE OVERRIDE INPUT
11	AUX INPUT (0-5V, 0-10V)
12	RS-485, B (-), INPUT/OUTPUT
13	RS-485, A (+), INPUT/OUTPUT

Product Dimensions (continued)

SLAMf51, DeviceNet

MM/1 INCH

CABLE CONNECTOR	"W" DIMENSION
CABLE GLAND 0.20 (5.1) TO 0.39 (9.9) DIA. CABLE	28.6 (1.12)
1/2" NPT-F CONDUIT	16.5 (0.65)
M20x1.5 (F) CONDUIT	12.5 (0.49)

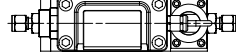
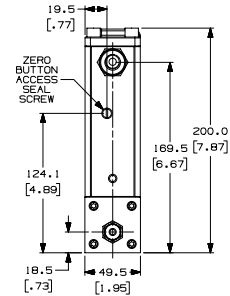

FRONT VIEW WITHOUT FILTER

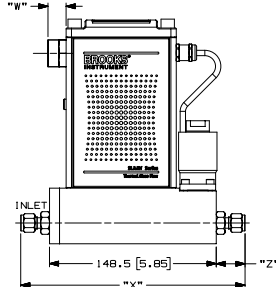

FRONT VIEW WITH STANDARD FILTER

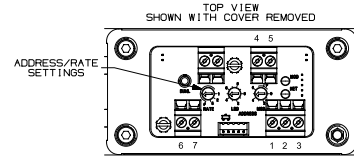
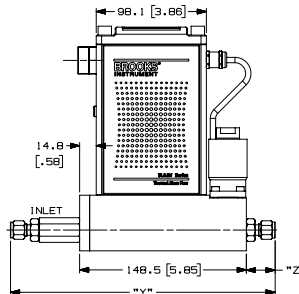

TERMINAL FUNCTION
1 DRAIN
2 POWER SUPPLY (11-25V)
3 POWER COMMON
4 CAN H
5 CAN L
6 AUX COMMON
7 AUX INPUT (0-5V, 0-10V)

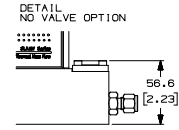

FITTING	"X" DIMENSION (Without Standard Filter)	"Y" DIMENSION (With Standard Filter)	"Z" DIMENSION
9/16"-18 UNF	148.5 (5.85)	184.5 (7.26)	N/A
1/4" TUBE COMP.	199.8 (7.87)	235.8 (9.28)	25.7 (1.01)
3/8" TUBE COMP.	202.9 (7.99)	238.8 (9.40)	27.2 (1.07)
1/2" TUBE COMP.	206.9 (8.15)	242.9 (9.56)	29.2 (1.15)
1/4" VCR	196.3 (7.73)	232.2 (9.14)	23.9 (0.94)
1/4" VCO	188.1 (7.41)	224.1 (8.82)	19.8 (0.78)
1/4" NPT	190.7 (7.51)	226.7 (8.92)	21.1 (0.83)
6mm TUBE COMP.	199.9 (7.87)	235.9 (9.28)	25.7 (1.01)
10mm TUBE COMP.	203.3 (8.00)	239.4 (9.42)	27.4 (1.08)
3/8"-1/2" VCR	203.9 (8.03)	239.9 (9.44)	27.7 (1.09)
3/8"-1/2" VCO	199.3 (7.85)	235.3 (9.26)	25.4 (1.00)
1/4" RC (BSP)	188.7 (7.43)	224.6 (8.84)	20.1 (0.79)

• OVERALL LENGTH FINGER TIGHT

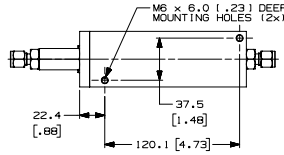

SLAMf61, Analog/RS485

MM/1 INCH

CABLE CONNECTOR	"W" DIMENSION
CABLE GLAND 0.20 (5.1) TO 0.39 (9.9) DIA. CABLE	28.6 (1.12)
1/2" NPT-F CONDUIT	16.5 (0.65)
M20x1.5 (F) CONDUIT	12.5 (0.49)

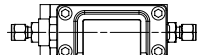
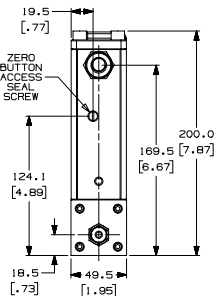

FRONT VIEW WITHOUT FILTER

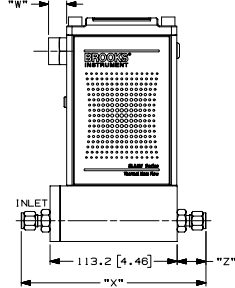

FRONT VIEW WITH STANDARD FILTER

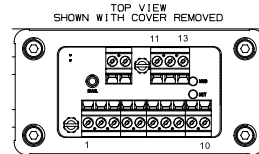
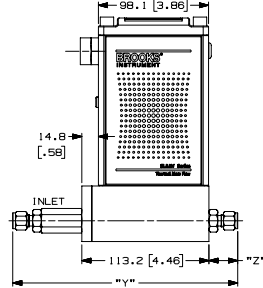

TERMINAL	FUNCTION
1 SETPOINT COMMON	
2 FLOW OUTPUT (0-5V, 1-5V)	
3 ALARM OUT	
4 FLOW OUTPUT (0-20mA, 4-20mA)	
5 POWER SUPPLY (13.5-27V)	
6 SETPOINT INPUT (0-20mA, 4-20mA)	
7 SETPOINT INPUT (0-5V, 1-5V)	
8 POWER COMMON	
9 FLOW OUT COMMON	
10 VALVE OVERRIDE INPUT	
11 AUX INPUT (0-5V, 0-10V)	
12 RS-485, B (-), INPUT/OUTPUT	
13 RS-485, A (+), INPUT/OUTPUT	

FITTING	"X" DIMENSION (Without Standard Filter)	"Y" DIMENSION (With Standard Filter)	"Z" DIMENSION
9/16"-18 UNF	113.2 (4.46)	149.2 (5.87)	N/A
1/4" TUBE COMP.	164.5 (6.48)	209.4 (8.24)	25.7 (1.01)
3/8" TUBE COMP.	167.6 (6.60)	212.5 (8.36)	27.2 (1.07)
1/2" TUBE COMP.	171.6 (6.76)	216.5 (8.52)	29.2 (1.15)
1/4" VCR	161.0 (6.34)	205.9 (8.10)	23.9 (0.94)
1/4" VCO	152.9 (6.02)	197.7 (7.78)	19.8 (0.78)
1/4" NPT	155.4 (6.12)	200.3 (7.89)	21.1 (0.83)
6mm TUBE COMP.	164.5 (6.48)	209.5 (8.25)	25.7 (1.01)
10mm TUBE COMP.	167.9 (6.61)	212.9 (8.39)	27.4 (1.08)
3/8"-1/2" VCR	168.7 (6.64)	213.5 (8.40)	27.7 (1.09)
3/8"-1/2" VCO	164.1 (6.46)	208.9 (8.22)	25.4 (1.00)
1/4" RC (BSP)	153.4 (6.04)	198.3 (7.81)	20.1 (0.79)

• OVERALL LENGTH FINGER TIGHT

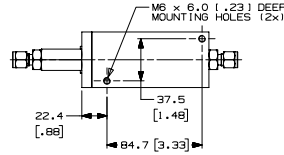

Product Dimensions (continued)

SLAMf60, Profibus

MM/1 INCH

CABLE CONNECTOR CABLE GLAND 0.20 [5.1] TO 0.39 [9.9] DIA. CABLE	"W" DIMENSION
	28.6 [1.12]
1/2" NPT-F CONDUIT	16.5 [0.65]
M20x1.5 (F) CONDUIT	12.5 [0.49]

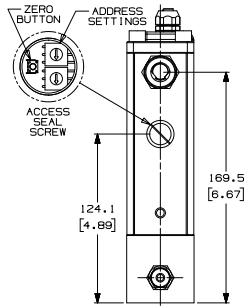

FITTING	"X" DIMENSION
1/8" TUBE COMP.	*145.3 [5.72]
1/4" TUBE COMP.	*149.9 [5.90]
3/8" TUBE COMP.	*152.9 [6.02]
1/2" TUBE COMP.	*157.0 [6.18]
1/4" VCR	146.3 [5.76]
1/4" VCO	138.2 [5.44]
1/4" NPT-F	140.7 [5.54]
6mm TUBE COMP.	*149.9 [5.90]
10mm TUBE COMP.	*153.2 [6.03]
3/8"-1/2" VCR	153.9 [6.06]
3/8"-1/2" VCO	149.4 [5.88]
1/4" RC-F (BSP)	138.8 [5.46]

* OVERALL LENGTH FINGER TIGHT

PROFIBUS M12 CONNECTOR
5-PIN FEMALE
M12x1 INTERNAL THREAD
ORIENTATION OF KEY NOT FIXED

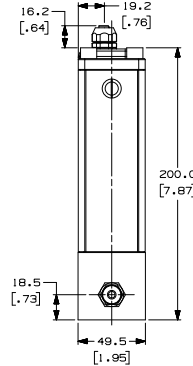
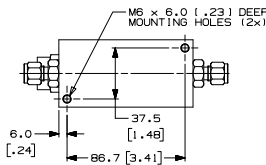
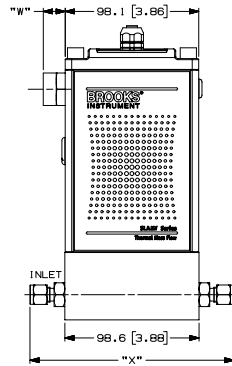
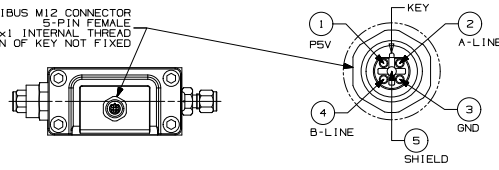

TOP VIEW
SHOWN WITH COVER REMOVED

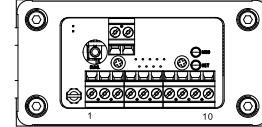

TERMINAL	FUNCTION
1	POWER SUPPLY (13.5-27V)
2	VALVE OVERRIDE INPUT
3	POWER COMMON
4	AUX COMMON
5	AUX INPUT (0-5V, 0-10V)
6	P5V (BROWN)
7	RXD/TXD - A-LINE (GREEN)
8	GROUND (BLUE)
9	RXD/TXD - B-LINE (RED)
10	SHIELD (GRAY)

Product Dimensions (continued)

SLAMf53, Profibus

MM/1 INCH

CABLE CONNECTOR	"W" DIMENSION
CABLE GLAND 0.20 (5.1) TO 0.39 (9.9) DIA.	28.6 (1.12)
CABLE 1/2" NPT-F CONDUIT	16.5 (0.65)
M20x1.5 (F) CONDUIT	12.5 (0.49)

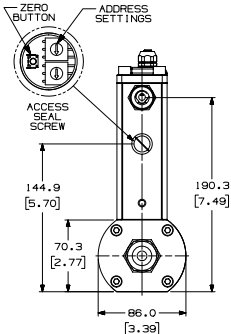

FITTINGS	"X" DIMENSION
9/16" - 18 UNF	235.4 (9.27)
1-1/16" - 12 UN	235.4 (9.27)
1-5/16" - 12 UN	235.4 (9.27)
1/2" NPT	235.4 (9.27)
1" NPT	235.4 (9.27)
1-1/2" NPT	235.4 (9.27)
1/2" RC (BSP)	235.4 (9.27)
1" RC (BSP)	235.4 (9.27)
3/8" TUBE COMP.	*290 (11.42)
1/2" TUBE COMP.	*304 (11.97)
3/4" TUBE COMP.	*304 (11.97)
1" TUBE COMP.	*311.7 (12.27)
1/2" VCO	286.3 (11.27)
3/4" VCO	293.9 (11.57)
1" VCO	296.4 (11.67)
1/2" VCR	293.9 (11.57)
3/4" VCR	316.7 (12.47)

* OVERALL LENGTH FINGER TIGHT

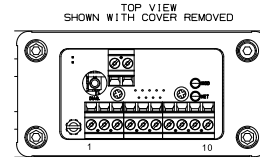
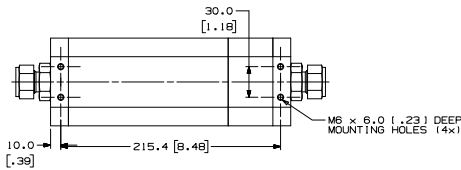
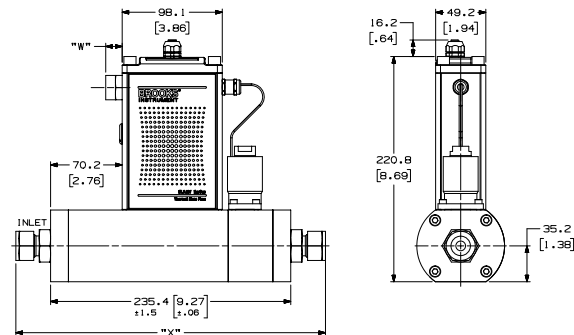
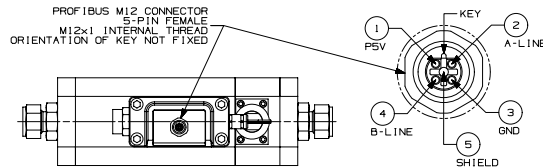

TERMINAL	FUNCTION
1	POWER SUPPLY (13.5-27V)
2	VALVE OVERRIDE INPUT
3	POWER COMMON
4	AUX COMMON
5	AUX INPUT (0-5V, 0-10V)
6	PROFIBUS M12 CONNECTOR WIRES TO TERMINALS 6-10
6	PSV (BROWN)
7	RXD/TXD - A-LINE (GREEN)
8	GROUND (BLUE)
9	RXD/TXD - B-LINE (RED)
10	SHIELD (GRAY)

SLAMf63, DeviceNet

MM/1 INCH

CABLE CONNECTOR	"W" DIMENSION
CABLE GLAND 0.20 (5.1) TO 0.39 (9.9) DIA.	28.6 (1.12)
CABLE 1/2" NPT-F CONDUIT	16.5 (0.65)
M20x1.5 (F) CONDUIT	12.5 (0.49)

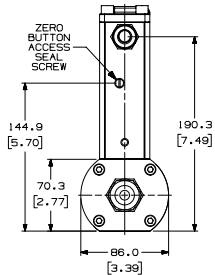

FITTINGS	"X" DIMENSION
9/16" - 18 UNF	191.6 (7.54)
1-1/16" - 12 UN	191.6 (7.54)
1-5/16" - 12 UN	191.6 (7.54)
1/2" NPT	191.6 (7.54)
1" NPT	191.6 (7.54)
1-1/2" NPT	191.6 (7.54)
1/2" RC (BSP)	191.6 (7.54)
1" RC (BSP)	191.6 (7.54)
3/8" TUBE COMP.	*246.0 (9.69)
1/2" TUBE COMP.	*260.4 (10.25)
3/4" TUBE COMP.	*260.4 (10.25)
1" TUBE COMP.	*268.0 (10.55)
1/2" VCO	242.6 (9.55)
3/4" VCO	250.2 (9.85)
1" VCO	252.7 (9.95)
1/2" VCR	250.2 (9.85)
3/4" VCR	273.1 (10.75)

* OVERALL LENGTH FINGER TIGHT

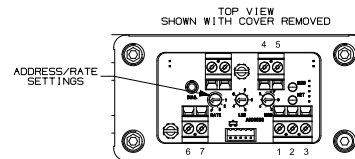
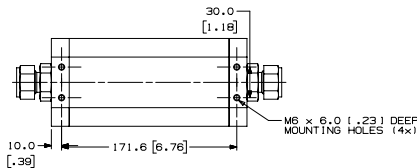
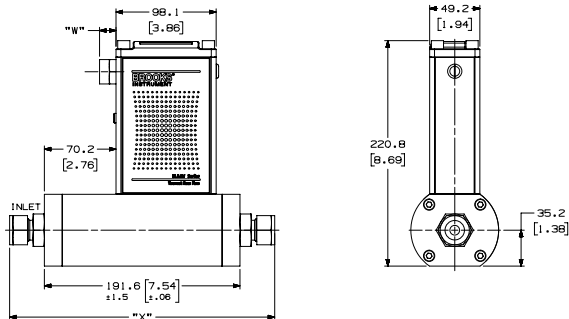
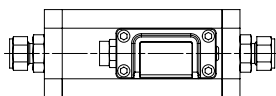

TERMINAL	FUNCTION
1	DRAIN
2	POWER SUPPLY (11-25V)
3	POWER COMMON
4	CAN_H
5	CAN_L
6	AUX COMMON
7	AUX INPUT (0-5V, 0-10V)

Model Code

Code Description	Code Option	Option Description
I. Base Model Numbers	SLA	Smart Link Advantage
II. Package / Finish Specifications	MF	Standard Elastomer Series
III. Function	5	Mass Flow Controller
	6	Mass Flow Meter
IV. Gas or Range	0	3 ccm - 50 lpm
	1	20 - 100 lpm
	3	100 - 2500 lpm
V. Digital I/O Communication	A	None (select applicable analog I/O)
	D	DeviceNet I/O (with 5-pin micro connector)
	J	DeviceNet I/O (with PG11 cable gland)
	K	DeviceNet I/O (with M20x1.5 conduit)
	L	DeviceNet I/O (with 1/2" NPT (F) conduit)
	P	Profibus (5-pin female M12, M20x1.5 conduit)
	R	Profibus (5-pin female M12, PG11 cable gland)
	T	Profibus (5-pin female M12, 1/2" NPT (F) conduit)
VI. Mechanical Connection (Body size 0 & 1 only)	1A	Without adapters, 9/16" - 18 UNF
	1B	1/4" tube compression
	1C	1/8" tube compression
	1D	3/8" tube compression
	1E	1/4" VCR
	1F	1/4" VCO
	1G	1/4" NPT
	1H	6mm tube compression
	1J	10mm tube compression
	1L	3/8"-1/2" VCR
	1M	3/8"-1/2" VCO
	1P	1/2" tube compression
	1T	1/4" RC (BSP)
	1Y	3mm tube compression
	B1	1/4" tube compression w/Filter
	C1	1/8" tube compression w/Filter
	D1	3/8" tube compression w/Filter
	E1	1/4" VCR w/Filter
	F1	1/4" VCO w/Filter
	G1	1/4" NPT w/Filter
	H1	6mm tube compression w/Filter
	J1	10mm tube compression w/Filter
	L1	3/8"-1/2" VCR w/Filter
	M1	3/8"-1/2" VCO w/Filter
	P1	1/2" tube compression w/Filter
	T1	1/4" RC (BSP) w/Filter
	Y1	3mm tube compression w/Filter
VI. Mechanical Connection (Body size 3 only)	2A	Without adapters, 9/16" - 18 UNF
	2B	1-1/16"-12 SAE/MS
	2C	3/8" tube compression
	2D	1/2" tube compression
	2E	3/4" tube compression
	2F	1" tube compression
	2G	1/2" NPT (F)
	2H	1" NPT (F)
	2J	1-1/2" NPT (F)
	2K	1/2" VCO
	2L	3/4" VCO
	2M	1/2" VCR
	2N	1/2" RC (BSP)
	2P	1" RC (BSP)
	2R	1-5/16"-12 SAE/MS
	2S	1" VCO
	2T	3/4" VCR
	2U	1" VCR
	3A	DIN DN15 PN40 Flange
	3B	DIN DN25 PN40 Flange
	3C	DIN DN40 PN40 Flange
	3D	DIN DN15 PN40 Flange

Model Code (continued)

Code Description	Code Option	Option Description		
VI. Mechanical Connection (cont.) (Body size 3 only)	3E	ANSI 1/2" 150# RF Flange		
	3F	ANSI 1/2" 300# RF Flange		
	3G	ANSI 1" 150# RF Flange		
	3H	ANSI 1" 300# RF Flange		
	3J	ANSI 1-1/2" 150# RF Flange		
	3K	ANSI 1-1/2" 300# RF Flange		
VII. O-ring Material	A	Viton		
	B	Buna		
	C	PTFE		
	D	Kalrez		
	E	EPDM		
	J	FDA/USP Class VI - Viton		
L	FDA/USP Class VI - EPDM			
VIII. Valve Seat	A	None (Sensor only)		
	B	Viton (for body size 3, diaphragm material = PTFE)		
	C	Buna (for body size 3, diaphragm material = PTFE)		
	D	Kalrez (for body size 3, diaphragm material = PTFE)		
	E	EPDM (for body size 3, diaphragm material = PTFE)		
	F	PTFE		
IX. Valve Type	0	None (Sensor only)		
	1	Normally closed		
	2	Normally closed (Pressure diff. >30 psig (2 bar))		
	3	Normally closed (Pressure diff. <30 psig (2 bar))		
	4	Normally closed - high pressure		
	5	Normally open		
X. Analog I/O Communications	A	None - Digital Communications only		
	E	4-20 mA	0-5 Volt	PG11 Cable Gland
	F	0-5 Volt	0-5 Volt	PG11 Cable Gland
	G	4-20 mA	4-20 mA	PG11 Cable Gland
	H	0-5 Volt	4-20 mA	PG11 Cable Gland
	I	0-5 Volt	0-20 mA	PG11 Cable Gland
	J	0-5 Volt	0-5 Volt	1/2" NPT (F) Conduit
	K	4-20 mA	0-20 mA	1/2" NPT (F) Conduit
	N	0-5 Volt	0-5 Volt	M20x1.5 Conduit
	O	0-5 Volt	0-20 mA	M20x1.5 Conduit
	P	4-20 mA	0-5 Volt	M20x1.5 Conduit
	Q	0-20 mA	0-5 Volt	M20x1.5 Conduit
	R	1-5 Volt	1-5 Volt	PG11 Cable Gland
	S	0-20 mA	0-20 mA	PG11 Cable Gland
	T	1-5 Volt	1-5 Volt	1/2" NPT (F) Conduit
	U	0-20 mA	0-20 mA	1/2" NPT (F) Conduit
	V	0-5 Volt	0-5 Volt	M20x1.5 Conduit
	W	1-5 Volt	1-5 Volt	M20x1.5 Conduit
	X	0-20 mA	0-20 mA	M20x1.5 Conduit
	Y	4-20 mA	0-5 Volt	M20x1.5 Conduit
Z	0-20 mA	0-5 Volt	PG11 Cable Gland	
5	0-5 Volt	0-5 Volt	1/2" NPT (F) Conduit	
6	0-5 Volt	0-20 mA	1/2" NPT (F) Conduit	
7	4-20 mA	0-5 Volt	1/2" NPT (F) Conduit	
8	0-20 mA	0-5 Volt	1/2" NPT (F) Conduit	
XI. Power Supply Inputs	1	±15 Vdc		
	2	24 Vdc		
XII. Output Enhancements	A	Standard response		
	B	Fast response		
XIII. Certification	1	Safe Area		

Sample Standard Model Code

I	II	III	IV	V	VI	VII	VIII	IX	X	XI	XII	XIII
SLA	MF	5	0	S	1A	A	B	1	E	1	A	1

Brooks Service and Support

Brooks is committed to assuring all of our customers receive the ideal flow solution for their application, along with outstanding service and support to back it up. We operate first class repair facilities located around the world to provide rapid response and support. Each location utilizes primary standard calibration equipment to ensure accuracy and reliability for repairs and recalibration and is certified by our local Weights and Measures Authorities and traceable to the relevant International Standards.

Visit www.BrooksInstrument.com to locate the service location nearest to you.

START-UP SERVICE AND IN-SITU CALIBRATION

Brooks Instrument can provide start-up service prior to operation when required. For some process applications, where ISO-9001 Quality Certification is important, it is mandatory to verify and/or (re)calibrate the products periodically. In many cases this service can be provided under in-situ conditions, and the results will be traceable to the relevant international quality standards.

CUSTOMER SEMINARS AND TRAINING

Brooks Instrument can provide customer seminars and dedicated training to engineers, end users, and maintenance persons.

Please contact your nearest sales representative for more details.

HELP DESK

In case you need technical assistance:

Americas ☎ 1 888 554 FLOW
Europe ☎ +31 (0) 318 549 290
Asia ☎ +81 3 (0) 5633 7100

Due to Brooks Instrument's commitment to continuous improvement of our products, all specifications are subject to change without notice.

TRADEMARKS

Brooks Brooks Instrument, LLC
DeviceNet Open DeviceNet Vendors Association
Kalrez DuPont Performance Fluoroelastomers
Profibus Profibus International
SolidSensell Brooks Instrument, LLC
Teflon E.I. DuPont de Nemours & Co.
VCO Swagelok Co.
VCR Swagelok Co.
Viton DuPont Performance Fluoroelastomers



Brooks Instrument
407 West Vine Street
P.O. Box 903
Hatfield, PA 19440-0903 USA
T (215) 362 3700
F (215) 362 3745
E-Mail BrooksAm@BrooksInstrument.com
www.BrooksInstrument.com

Brooks Instrument
Neonstraat 3
6718 WX Ede, Netherlands
T +31 (0) 318 549 300
F +31 (0) 318 549 309
E-Mail BrooksEu@BrooksInstrument.com

Brooks Instrument
1-4-4 Kitasuna Koto-Ku
Tokyo, 136-0073 Japan
T +81 (0) 3 5633 7100
F +81 (0) 3 5633 7101
E-Mail BrooksAs@BrooksInstrument.com

BROOKS[®]
INSTRUMENT