

# GF Series

## GF100/GF120/GF125

Thermal Mass Flow

### High Purity/Ultra-High Purity Digital Thermal Mass Flow Devices



GF100 Series

#### Overview

Designed for semiconductor, MOCVD, and other gas flow control applications that require a high purity all-metal flow path, the Brooks® GF100 Series mass flow controllers and meters deliver outstanding performance, reliability, and flexibility. Highlights of the GF Series industry-leading features include: ultra fast 300 millisecond settling time, MultiFlo™ gas and range programmability, optional pressure transient insensitivity (PTI), local display, extremely low wetted surface area, and corrosion resistant Hastelloy® sensor tube and valve seat. The GF100 Series has been marathon tested to over three times the semiconductor industry standard for reliability, ensuring repeatable low-drift performance over time. An independent diagnostic/service port permits users to troubleshoot or change flow conditions without removing the mass flow controller from service.

The flagship GF125 is a second generation multi-variable, pressure transient insensitive mass flow controller. This product builds upon Brooks' leadership position in pressure transient insensitive (PTI) mass flow controller technology, minimizing process gas flow variation due to pressure and temperature fluctuations. The GF125 enables customers to simplify and reduce the size and cost of gas panels by eliminating the need for point of use pressure regulators, pressure transducers, and associated hardware.

MultiFlo™ gas and range programmability, a patented technology developed and refined by Brooks over the last 10 years, has changed the mass flow controller industry by offering customers the ability to select new gas calibrations and full scale ranges without the trouble and cost of removing the mass flow controller from the gas line. The GF Series fourth generation MultiFlo technology continues to lead the market with the most accurate and broadest range performance through extensive refinement and physical validation on critical process gases.

#### Product Description

The GF100 Series is a highly configurable platform based on a novel modular architecture. Already widely adopted by semiconductor, vacuum thin film, solar, and related customers, the GF100 Series feature set was carefully selected to enable drop-in replacement and upgrade of most brands of metal-seal mass flow controllers, including the former Celerity, UNIT, Tylan, and Mykrolis brands. With the wide range of options and features available, the GF100 Series provides users with a path to simplification and standardization, greatly reducing spares inventory and support costs.

## Features and Benefits

**Convenient Service Port**

- Easy diagnostics and troubleshooting
- Independent of tool communication

**User Interface**

- Easy installation, start-up, and operation

**Mechanically Coupled Valve**

- Corrosion resistant all metal valve
- Diaphragm free design, unaffected by differential pressure
- High purge rate capability
- Tested for over four million cycles with no failures

**Second Generation T-Rise Sensor**

- Excellent long-term stability ( $<\pm 0.5\%$  F.S./yr.)
- Improved signal to noise ratio
- High purge rate capability
- Lower temperature operation for gases prone to thermal decomposition

**Temperature Sensor**

- Accurate flow and temperature measurement over full temperature range
- Real-time compensation for ambient temperature fluctuations enable precise gas chemistry control

**Pressure Sensor**

- Stable flow control regardless of upsets or fluctuations in delivery pressure

Features	Benefits
MultiFlo Gas and Range Configurability	Ability to reconfigure the mass flow controller for new gas calibrations and full scale ranges without the time and costs of removing the device from the gas line.
User Accessible Service Port with Advanced Diagnostics with User-Friendly Interface	Convenient interface to diagnostics for maximum uptime. Ensures device is operating within user specified limits for high yield and maximum uptime.
Corrosion Resistant Hastelloy T-Rise Sensor	Provides unmatched long-term sensor stability ensuring maximum yield and throughput.
Pressure Transient Insensitivity (PTI), High Accuracy (HA), Safe Delivery System (SDS) Options	Improves yield. Reduces overall gas panel costs.

## Product Description

### Ultra Fast Response

By combining Brooks' patented flow sensor technology with a high speed ARM processor and fast acting diaphragm free valve assembly, the GF100 Series delivers up to 3 times faster response and settling time compared to other mass flow controllers, enabling:

- Improved wafer throughput by reducing nonproductive flow settling steps
- Critical Etch processes requiring ultrafast 1-2 second etch steps
- Reduced diverted gas consumption and associated abatement costs
- Time-sensitive gas delivery steps in Atomic Layer Deposition
- For processes requiring a slow ramped gas turn-on or time critical transitions between flow rates. A user programmable ramp function is provided

### MultiFlo™ Gas and Range Configurability

A major advancement over traditional single point gas conversion factors, Brooks MultiFlo technology delivers up to a three-times improvement in process gas accuracy. This is achieved through advanced gas modeling optimized through actual gas testing providing compensation for non-linear gases. MultiFlo also allows the device to be quickly and easily configured for another gas and/or flow range without sacrificing accuracy or rangability. Selecting a new gas automatically creates a new calibration curve, establishes optimized PID settings for dynamic control, automatically compensates for gas density effects, and ensures smooth, overshoot-free transitions between flow rates with excellent steady-state stability.

Brooks MultiFlo technology offers unparalleled flexibility; a single device can be programmed for thousands of different gas and flow range configurations.

Re-programming is simple and fast; a new gas and range can be programmed in under 30 seconds. Brooks provides a full gas database to ensure the true value of MultiFlo is realized:

- Dramatically reduces inventory costs
- Mass flow controller full scale flow range can re-scaled down typically by a factor of 3:1 with no impact on accuracy, turndown or leak by specifications, for optimum process and inventory flexibility
- Up to 40% fewer configurations required to support typical etch and CVD processes verses our closest competitor
- Widest process gas coverage through extensive gas library
- Mass flow controllers can be replaced in only a few minutes
- Off-the shelf spares programmability enables rapid process recovery
- Maximum flexibility for research applications

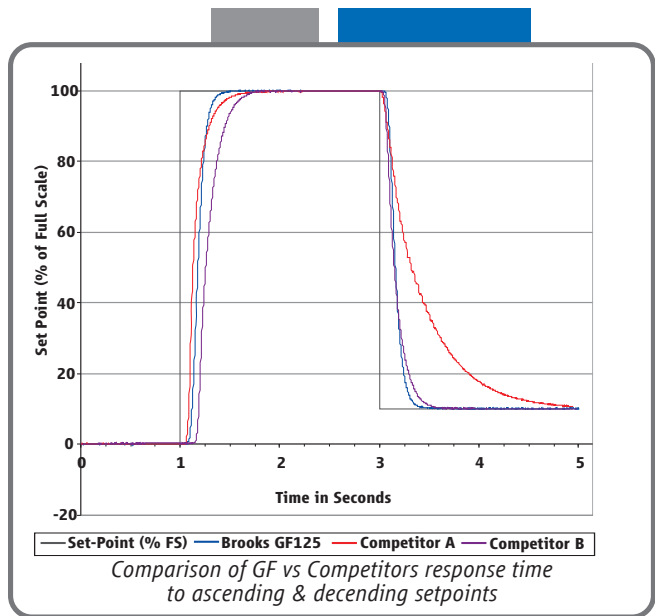

**GF Series MFC**

3.6L He	3.6L Ar	1.6L Xe	2.6L H2
2.6L CO	2.1L HBr	2.6L N2	1.6L C12
1.8L H2Se	2.0L NH3	1.9L PH3	1.7L COS
1.5L SiH4	1.3L NF3	1.5L COF2	...

MultiFlo™ technology allows one GF Series to be programmed for thousands of different gases and flow ranges

# of Platforms	GF1xx Series Range	Competitor A 2 Models Range	Competitor B 4 Models Range
1	3 - 10	10	1 - 5
2	11 - 30	17.5	6 - 14
3	31 - 92	30	15 - 27
4	93 - 280	55	28 - 38
5	281 - 860	100	39 - 71
6	861 - 2,600	175	72 - 103
7	2,601 - 7,200	300	104 - 192
8	7,201 - 15,000	550	193 - 279
9	15,001 - 30,000	1,000	280 - 754
10	30,001 - 40,000	1,750	755 - 2,037
11	40,001 - 55,000	3,000	2,038 - 5,500
12		5,500	5,501 - 11,000
13		10,000	11,001 - 30,000
14		22,000	30,001 - 50,000
15		30,000	
16		50,000	

The Brooks Advantage! Less platforms means more process flexibility and lower cost of spares.

## Product Description

### MultiFlo™ Configurator Accessory Kits:

#### 778Z010ZZZ

#### **Basic MultiFlo Configurator Kit**

A331710003  
214F027AAA

\*Software, MultiFlo Configurator  
Cable Assembly 2.5mm  
USB-RS232 Converter with DB-9 female

#### 778Z011ZZZ

#### **Basic MultiFlo Configurator Kit w/Power Supply and Adapter Cables**

A331710003  
214F027AAA  
A332295001  
A332297002  
A332297001

\*Software, MultiFlo Configurator  
Cable Assembly 2.5mm  
USB-RS232 Converter with DB-9 female  
Power Supply MFC  
Cable, Power, 9-Pin  
Cable, Power, DeviceNet

\* MultiFlo Configurator Software is available on the Brooks Instrument website at: [www.BrooksInstrument.com/MultiFlo](http://www.BrooksInstrument.com/MultiFlo)

### Pressure Transient Insensitivity (PTI) (GF125 only)

Cost and space constraints are driving gas panel designers to remove point of use pressure regulators and pressure monitoring components, placing more burden on the mass flow controller to control accurately under dynamic pressure conditions. Conventional mass flow controllers react strongly to small inlet pressure fluctuations resulting in unstable performance and unpredictable accuracy (see Non-Pressure Insensitive MFC). This drove Brooks to develop Pressure Transient Insensitive mass flow controller technology (PTI-MFC).

The GF125 PTI-MFC is a second generation PTI-MFC utilizing a patented control algorithm that inverts the pressure signal, compares it to the pre-fluctuation signal and drives real-time valve position compensation to maintain stable flow. Enhanced pressure transient insensitivity is achieved through faster sensing, faster processing, and a reduction in internal dead-volume between the sensors and valve orifice.

### Advanced Thermal Flow Measurement Sensor

Brooks' proprietary sensor technology combines:

- Improved signal to noise performance for improved accuracy at low setpoints
- Improved reproducibility at elevated temperatures through new isothermal packaging, onboard conditioning electronics with ambient temperature sensing and compensation
- Improved long-term stability through enhanced sensor manufacturing and burn in process
- Highly corrosion resistant Hastelloy C-22 sensor tube
- Optimized temperature profile for gases prone to thermal decomposition
- Unique orthogonal sensor mounting orientation
  - Eliminates sensor drift caused by valve heating effects
  - Eliminates thermal siphoning effects for the most common mounting orientations

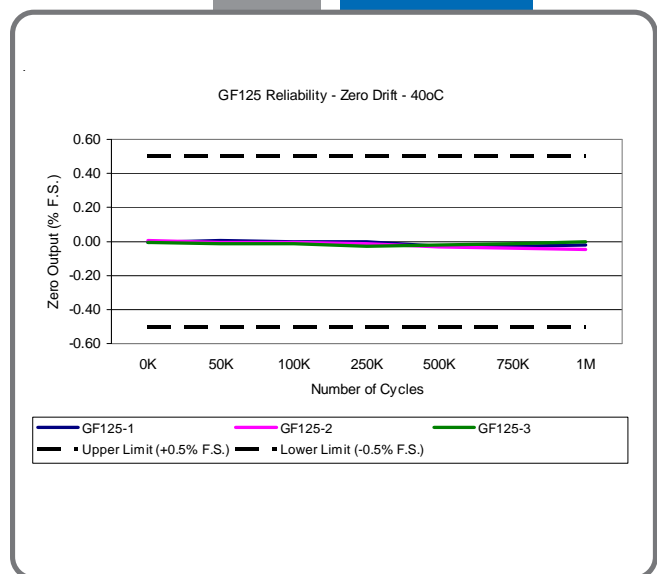
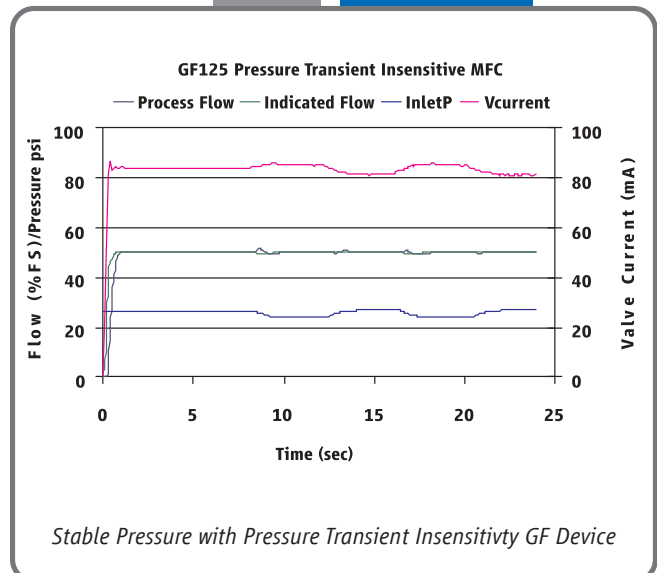
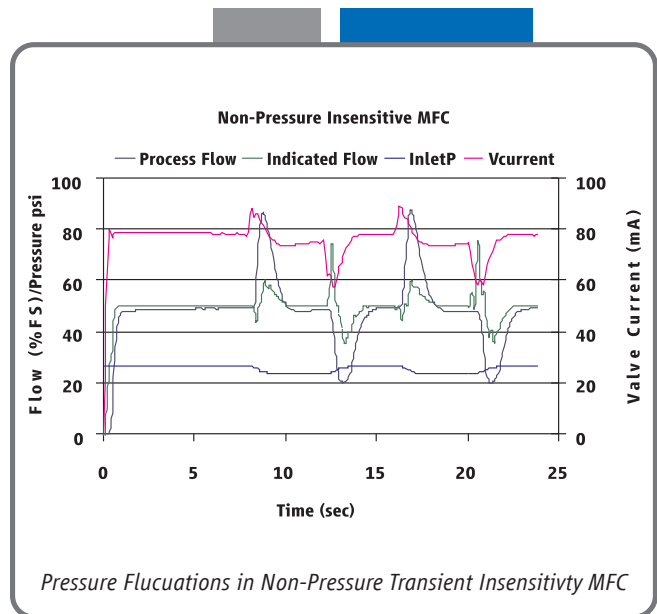

## Product Description

### High Purity Flow Path

All metal, corrosion resistant flow path with reduced surface area and un-swept volumes for faster dry-down during purge steps:

- SEMI F-20 compliant wetted flow path
- 4  $\mu$  inch Ra max surface finish standard (10  $\mu$  inch Ra on GF100)
- Highly corrosion resistant Hastelloy C-22 valve seat and jet orifice

### Extensive Mechanical Configuration Support

GF100 Series supports all metal seal / UHP industry gas connection interface standards for full OEM and process coverage

- Downport 80mm and 92mm C-seal and W-Seal, on 1.125" and 1.5" bodies
- Downport 80mm CS seal on 1.5" body
- 124 mm 1/4" VCR Male on 1.5" body

### Enhanced Diagnostics

The mass flow controller remains the most complex and critical component in gas delivery systems. When dealing with UHP gas distribution or highly toxic or corrosive gases, removing the mass flow controller to determine if it is faulty should be the last resort. In response to this, Brooks pioneered smarter mass flow controllers with embedded self test routines and introduced an independent diagnostic/service port to provide the user with a simple interface, for troubleshooting without disturbing flow controller operation.

### User Interface

The user interface has a high visibility LCD display that provides a local indication of Flow (%), Temperature ( $^{\circ}$ C), Pressure (PSIA/KPa) and Network Address, selectable through the Display button.

A Zero button provides a simple means to re-zero the mass flow controller as part of scheduled maintenance.

### Communication Interface

The GF100 Series supports analog 0-5 Vdc, RS485, and DeviceNet™ communication protocols. A range of low profile adapter cables facilitate replacing older mass flow controllers with the GF100 Series eliminating the need to carry mass flow controllers of same gas/range but different electrical connectors.

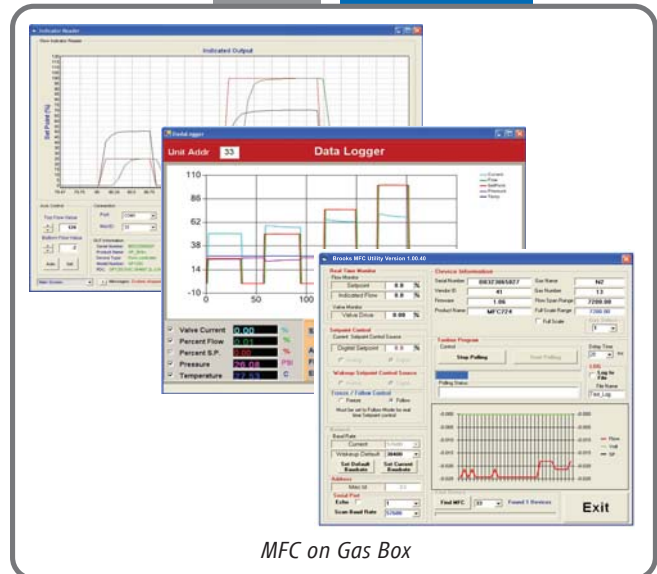
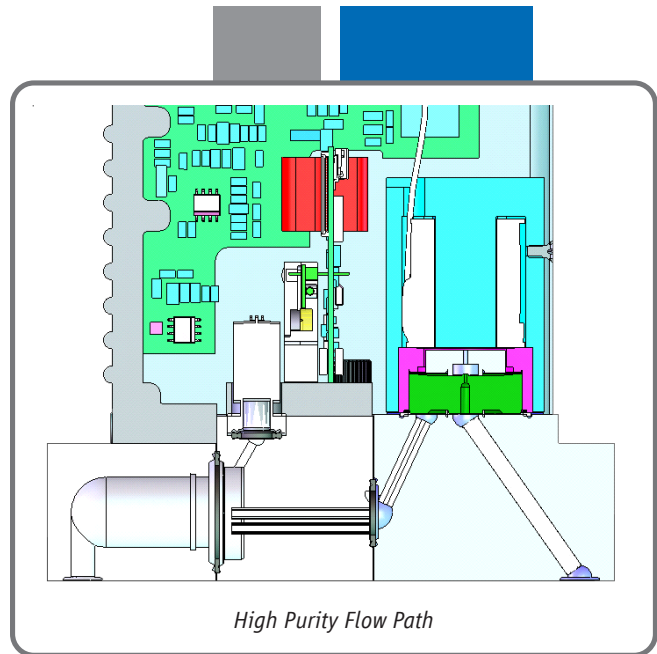

## Product Applications

### Thin Film - Semiconductor / Solar

Developed to meet the diverse process requirements in semiconductor, LED, vacuum thin film, solar, and related industries, the GF Series is a single platform solution for advanced etch, chemical vapor deposition (CVD, PECVD, ALD, MOCVD), physical vapor deposition (PVD), rapid thermal processing (RTP), diffusion, and other similar processes.

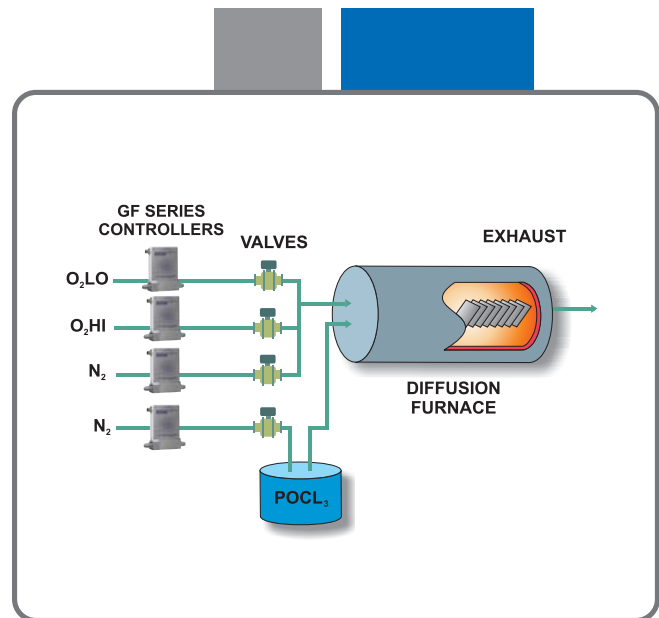

### Etch Process

The transition to 22nm node and complex 3D device geometries place greater profile and variability control challenges on the etch tool and its gas delivery sub system.

Creating and maintaining highly reproducible gas chemistry requires leading edge mass flow control.

The GF125 has become the preferred mass flow controller of many of the leading etch OEMs through the combination of its ultra fast 300msec flow settling time, pressure transient insensitivity, rangeability and process gas accuracy.

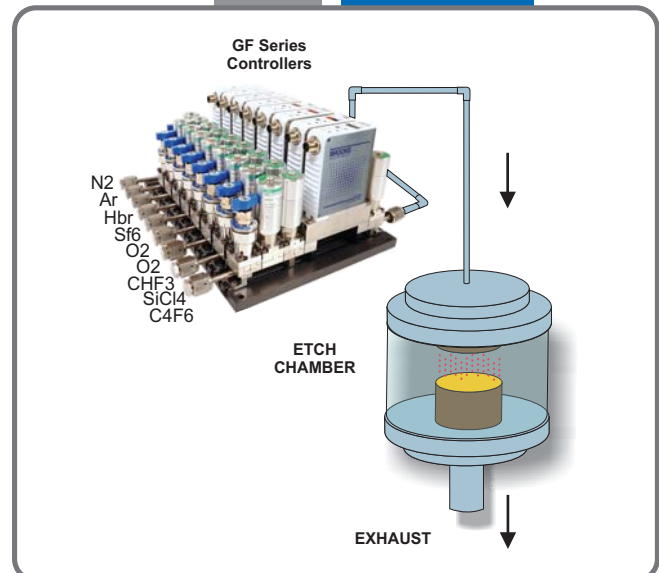

### Deposition Process

Chemical Vapor Deposition (CVD), the broadest family of processes, requires a diverse range of gases, precursors and flow rates.

The GF platform has been selected by leading CVD Equipment OEMs requiring an mass flow controller capable of meeting their broad process requirements.

The GF Series combines operating range (typical 3:1 programmability), process gas accuracy and low pressure drop/ low temperature flow sensing to present the optimal feature - set for advanced CVD processing.

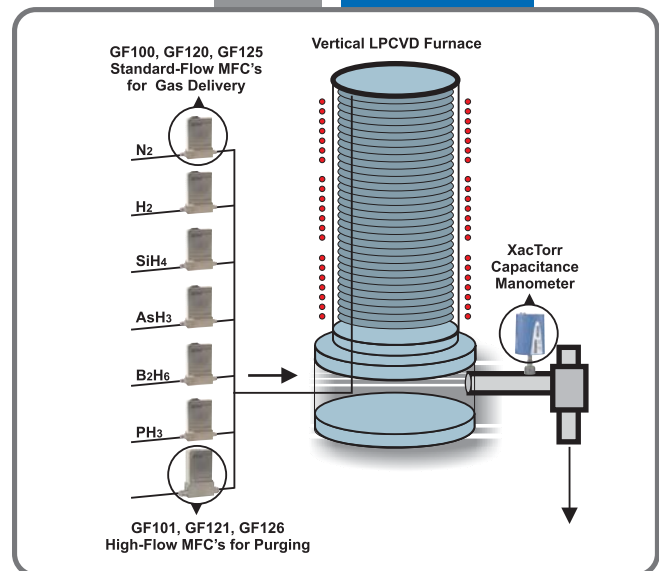

## Product Specifications (Standard GF Series)

Performance	GF100	GF120	GF125
Full Scale Flow Range (N <sub>2</sub> Eq.)	3 sccm to 55 slm		
Flow Accuracy	±1% S.P. > 35-100%, ±0.35% F.S. 2-35%		
Repeatability & Reproducibility	< ± 0.15% S.P.		
Linearity	± 0.5% F.S. (included in accuracy)		
Response Time (Settling Time) Normally Closed Valve	< 1 sec	700ms	300ms (3-860 sccm N <sub>2</sub> Eq.) 400ms (861-7200 sccm N <sub>2</sub> Eq.) 500ms (7201-30000 sccm N <sub>2</sub> Eq.) <700ms (30001-55000 sccm N <sub>2</sub> Eq.)
Normally Open Valve	<1.5 sec		
Pressure Insensitivity	Not Applicable		< 5% SP up to 5 psi/sec upstream press. spike
Control Range	2-100% (Normally Closed Valve)	3-100% (Normally Open Valve)	
MultiFlo	optional	standard	
#of Bins	11 bins		
Valve Shut Down (N.C. Valve)	< 1% of F.S.		
Valve Shut Down (N.O. Valve)	2% of F.S.		
Zero Stability	< ± 0.5% F.S. per year		
Temperature Coefficient	Span: 0.05% S.P. per °C, Zero: 0.005% F.S. per °C		

### Ratings

Operating Temperature Range	10-50°C		
Differential Pressure Range*	3-860 sccm = 7-45 psid, 861- 7200 sccm = 10-45 psid, 7201-55000 sccm = 15-45 psid *Argon gas applications require an additional 10 psid differential pressure. Low vapor pressure gases require an inlet pressure of > 100 Torr, with vacuum on outlet (example SiCl <sub>4</sub> ). Contact Brooks Technical Support for more information.		
Maximum Operating Pressure	500 psia max	100 psia max	
Leak Integrity (external)	1x10 <sup>-11</sup> atm. cc/sec He		

### Mechanical

Valve Type	Normally Closed Normally Open Meter (no valve)		
Wetted Materials	GF100: SEMI F20 HP Compliant, 316L VIMVAR, Hastelloy C-22, 316L Stainless Steel, 304 Stainless Steel, KM-45 GF120/GF125: SEMI F20 UHP Compliant, 316L VIMVAR, Hastelloy C-22, 316L Stainless Steel, 304 Stainless Steel, KM-45		
Surface Finish	10µ inch Ra	4µ inch Ra (0.1 µm Ra)	

### Diagnostics & Display

Status Lights	MFC Health, Network Status		
Alarms	Sensor Output, Control Valve Output, Over Temperature, Power Surge/Sag, Network Interruption		
Display Type Viewing Angle / Viewing Distance Units Displayed / Resolution	Top Mount Integrated LCD Fixed / 10 feet Flow (%), Temp. (°C), Pressure (psia, kPa) / 0.1 (unit)		

### Electrical

Electrical Connection	RS485/Analog via 9-Pin "D" connector, DeviceNet™ via 5-Pin "M12" connector		
Digital Communication	RS485+ (model specific), DeviceNet (model specific), RS485 Diagnostic Port (all models)		
Diagnostic /Service Port	RS485 via 2.5mm jack		
Power Supply/Consumption	DeviceNet: 545mA max. @ +11-25 Vdc., 250mA max. @ 24Vdc RS485/Analog: 6 Watts max @ ±15Vdc. (±10%) or +24 Vdc (±10%)		

### Compliance

EMC	EC Directive 2004/108/EC CE: EN61326: 2006 (FCC Part 15 & Canada IC-subset of CE testing)		
Environmental Compliance	RoHS Directive (2011/65/EU) REACH Directive EC 1907/2006		

NOTE: See the following Safe Delivery System (SDS) and High Accuracy (HA) sections for optional detailed specifications

## Product Description GF125 High Accuracy (HA) Option

The **GF125 High Accuracy (HA)** is a gas and range specific model for critical gas process applications requiring the widest working range with tightest flow control accuracy. A typical application is for multi-step processes requiring a high flow rate (up to 10 slpm) and a very accurate low flow rate. Traditionally this has been addressed by using two mass flow controllers. With the **GF125(HA)** superior low setpoint accuracy, it is often possible to replace two (a high and low flow) mass flow controllers with one, providing immediate cost savings while freeing up a gas line for greater gas panel flexibility.

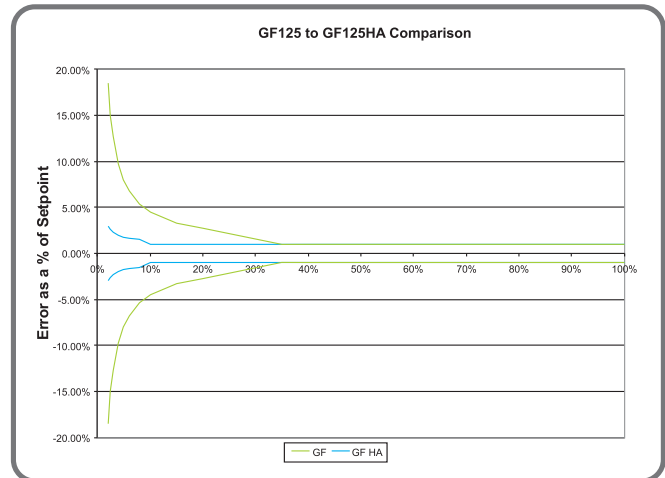

## Product Specifications GF125 High Accuracy (HA) Option

Performance	GF125(HA)
Full Scale Flow Range*	5 sccm - 10 slpm N <sub>2</sub> equivalent
Gases Supported	N <sub>2</sub> , O <sub>2</sub> , Ar, H <sub>2</sub> , SF <sub>6</sub> , NH <sub>3</sub> , CO <sub>2</sub> , Cl <sub>2</sub> , HBr, NF <sub>3</sub> , CF <sub>4</sub> , CH <sub>4</sub> , CH <sub>3</sub> F, CH <sub>2</sub> F <sub>2</sub> , SiCl <sub>4</sub> (@ 100 Torr), SiH <sub>4</sub> , C <sub>4</sub> F <sub>6</sub> -q (@ 800 Torr), C <sub>4</sub> F <sub>8</sub> (@ 1200 Torr), N <sub>2</sub> O, CHF <sub>3</sub> , SiH <sub>2</sub> Cl <sub>2</sub> , C <sub>5</sub> F <sub>8</sub> , He
MultiFlo Programmable*	Not Configurable
Flow Accuracy*	10-100%F.S.=±1.0%S.P. 1-10%F.S.=±1% S.P. plus ±0.04% F.S.
Repeatability & Reproducibility	< ±0.15% S.P.
Turn Down Ratio	100:1
Zero Stability	≤ 0.5% F.S. per year
Settling Time (to within ±2% F.S.)*	300ms (<860 sccm N <sub>2</sub> Equivalent) 400ms (861-7200 sccm N <sub>2</sub> Equivalent) 500ms (7201-10000 sccm N <sub>2</sub> Equivalent)
Warm Up Time	Minimum of 30 minutes
Leak Integrity	1X10 <sup>-11</sup> atm. cc/sec He
Valve Shut Down (Leak by)	<0.5% F.S.

Operating Conditions	GF125(HA)
Max. Operating Pressure	100 psia max
Pressure Insensitivity	±5% S.P. for up to 5 psi/sec. upstream press. spike
Differential Pressure** High Pressure Gases Low Pressure Gases	7-45 psid (N <sub>2</sub> , O <sub>2</sub> , Cl <sub>2</sub> , HBr, H <sub>2</sub> ) >100 Torr (SiCl <sub>4</sub> )
Valve Configuration*	Normally Closed
Ambient Temperature Range	10°C-50°C
Zero Temperature Coefficient	Span: 0.05% S.P. per °C, Zero: 0.005% F.S. per °C

\*Consult Technical Support for details.

\*\*Typical pressure drop. Actual pressure drop will be gas and flow dependent.



## Product Description GF120 Safe Delivery System (SDS®) Option

The **GF120 Safe Delivery System (SDS®)** is Brooks' state-of-the-art low pressure drop mass flow controller for the delivery of sub atmospheric safe delivery system (SDS) gases used in Implant and Etch processes. The Brooks GF120 (SDS) models are available in full scale flow ranges 4-25 sccm (option GF120XSL) or >25 sccm to 1 slpm (option GF120XSD).

These expensive, hazardous gases are adsorbed onto a solid medium within the gas cylinder, remaining below atmospheric pressure despite containing up to 15 times more dopant than conventional pressurized sources.

The amount of gas that can be extracted from the SDS controlled cylinder is highly dependent upon the final cylinder pressure. This is illustrated in SDS desorption species information in the SDS Gas Use Rate Efficiency Curve. Most of the gas is released at pressures below 100 Torr. The minimum cylinder pressure that can be reached is limited by the conductance of the mass flow controller regulating the flow. Most mass flow controllers require a 50 Torr differential pressure at flow rates of 5 sccm. At this 50 Torr limit, only ~65% of the dopant can be extracted from the adsorbent medium at normal operating temperatures. The **GF120 (SDS)** low pressure operation enables a further 30% of the dopant to be extracted, driving significant cost savings in SDS gases and equipment OEE.

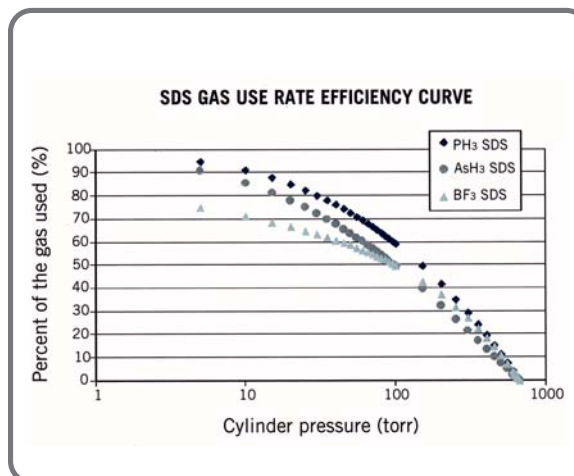

## Product Specifications (GF120XSD and GF120XSL) Options

Performance	GF120XSL	GF120XSD
Full Scale Flow Range (N <sub>2</sub> Eq.)	4 - 25 sccm	>25 to 1 slpm
Gases Supported	AsH <sub>3</sub> , PH <sub>3</sub> , BF <sub>3</sub> , SiF <sub>4</sub> , Ar, Xe, N <sub>2</sub> O, N <sub>2</sub> , GeF <sub>4</sub> , AsF <sub>5</sub> , PF <sub>3</sub> , H <sub>2</sub> Se, HMDSO, HMDSN, H <sub>2</sub> O***	
MultiFlo Programmable	Not Configurable	
Flow Accuracy	+/-0.35% F.S. <35% F.S.	
Repeatability & Reproducibility	+/-1% S.P. ≥35% F.S. <+/- 0.15% S.P.	
Zero Stability	<=0.6% F.S. per year	
Settling Time (to within +2% F.S.)	< 3 sec	
Warm Up Time	minimum of 30 minutes	
Leak Integrity	1X10 <sup>-11</sup> atm. cc/sec He	
Valve Shut Down (Leaky by)	<1% F.S.	

Operating Conditions	GF120XSD	GF120XSL
Minimum Operating Inlet Pressure*	4 to 20 sccm ≤ 10 Torr >20 to 50 sccm ≤ 20 Torr >50 sccm to 1 slpm ≤ 50 Torr	
Maximum Pressure	500 psia max	
Pressure Insensitivity	Not Available	
Differential Pressure**	10 Torr-30 psid typical (1.33-207 kPa typical)	
Valve Configuration	Normally Closed	
Ambient Temperature Range	10°C-50°C	
Zero Temperature Coefficient	Span: 0.05% SP per °C, Zero: 0.005% F.S. per °C	

\*Performance at minimum inlet pressure will be gas and flow range dependent. Consult Technical Support for details.

\*\*Typical pressure drop. Actual pressure drop will be gas and flow dependent. Consult Technical Support for details.

\*\*\*Consult factory for other gases.

# Electrical Interface Options

## Base I/O Options

### PDC Ordering Code G1

Description: Industry standard Analog / RS485 interface

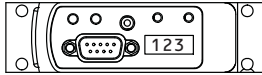

Pin No.	Signals
1	Valve Control
2	Output (0-5 Vdc)
3	+15 Vdc +24 Vdc
4	Pwr Com NC
5	-15 Vdc Pwr Com
6	Setpoint (0-5 Vdc)
7	Signal Common
8	RS-485 (DX+)
9	RS-485 (DX-)

### PDC Ordering Code TX

Description: Industry standard Analog only interface

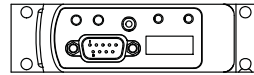

Pin No.	Signals
1	Valve Control
2	Output (0-5 Vdc)
3	+15 Vdc +24 Vdc
4	Pwr Com NC
5	-15 Vdc Pwr Com
6	Setpoint (0-5 Vdc)
7	Signal Common
8	No Connection
9	No Connection

### PDC Ordering Code GX

Description: OEM specific Analog / RS485 interface. Display and top plate re-oriented 180°

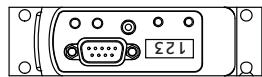

Pin No.	Signals
1	Valve Control
2	Output (0-5 Vdc)
3	+15 Vdc +24 Vdc
4	Pwr Com NC
5	-15 Vdc Pwr Com
6	Setpoint (0-5 Vdc)
7	Signal Common
8	RS-485 (DX+)
9	RS-485 (DX-)

### PDC Ordering Code SX

Description: Industry standard Analog 9-Pin Sub D connector and dual RJ11 RS485 ports

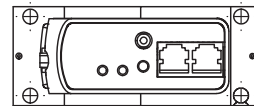

D-Sub Pin No.	Signals
1	Valve Control
2	Output (0-5 Vdc)
3	+15 Vdc +24 Vdc
4	Pwr Com NC
5	-15 Vdc Pwr Com
6	Setpoint (0-5 Vdc)
7	Signal Common
8	Signal Common
9	Valve Test Point

RJ11 J2 Pin No.	Signals
3	RS-485 (DX+)
2	RS-485 (DX-)

### PDC Ordering Code DX

Description: Industry standard ODVA compliant DeviceNet interface

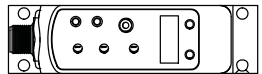

M12 Pin No.	Signals
1	Drain
2	V+ (11-25 Vdc)
3	V-
4	CAN-H
5	CAN-L

### PDC Ordering Code BB

Description: Industry standard ODVA compliant DeviceNet interface, Plus a separate Analog 0-5 Vdc Connector

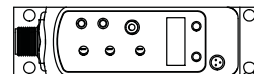

M12 Pin No.	Signals
1	Drain
2	V+ (11-25 Vdc)
3	V-
4	CAN-H
5	CAN-L

  

HIROSE Pin No.	Signals
1	Flow Out
2	AGND
3	GPIO CAP0
4	GHD Earth

All Base I/O options include: Diagnostic port communication RS485 via 2.5mm jack

## Electrical Interface Options (continued)

### I/O Options Using Base Model and Adapter Cable

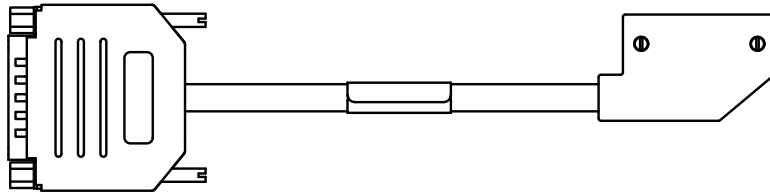

A range of low profile adapter cables have been developed to support replacing older generation MFC's with different pinout configurations. The base MFC will be either a, G1, TX or SX configuration, depending on the product being replaced.

#### PDC Ordering Code UX

Description: SX base I/O with 7003550 adapter for compatibility with Unit UDU15

Pin No	Signals	
9	VALVE OFF	
6	OUTPUT (0-5 VDC)	
4	+15 VDC	+24 VDC
7	PWR COM	NC
11	-15 VDC	PWR COM
15	SETPOINT (0-5 VDC)	
1,13,14	SIGNAL COMMON	
2	ZERO ALARM	
12	VALVE TEST POINT	
8	CASE GROUND	
3,5,10	NO CONNECTION	

#### PDC Ordering Code: T1

Description: TX base I/O with 7003551 adapter for compatibility with IFlow DB15 & TN 15 pin

Pin No	Signals	
15	VALVE OFF	
2	OUTPUT (0-5 Vdc)	
5	+15 VDC	+24 VDC
1	PWR COM	NC
6	-15 VDC	PWR COM
8	SETPOINT (0-5 VDC)	
9	COMMON	
10	COMMON	
14	CASE GROUND	
3,4,7	NO CONNECTION	
11,12,13	NO CONNECTION	

#### PDC Ordering Code: FX / JX

Description: SX base I/O with 7003069 (FX)/7001814 (JX) adapter for compatibility with Unit UDF9/UDJ9

Pin No	Signals	
1	VALVE CONTROL*	
2	OUTPUT (0-5 VDC)	
3	+15 VDC	+24 VDC
4	PWR COM	NC
5	-15 VDC	PWR COM
6	SETPOINT (0-5 VDC)	
7	SIGNAL COMMON	
8	SIGNAL COMMON	
9	VALVE TEST POINT	

#### PDC Ordering Code: EX

Description: GX base I/O with 7003083 adapter for compatibility with Unit "E", IN "L", "R"

Pin No	Signals	
J	VALVE OFF	
3	OUTPUT (0-5 VDC)	
4	+15 VDC	+24 VDC
2	PWR COM	NC
F	-15 VDC	PWR COM
A	SETPOINT (0-5 VDC)	
B,C,10	SIGNAL COMMON	
1	CASE GROUND	
5, 6, 8, 9	NOT CONNECTED	
I, D, E, H	NOT CONNECTED	
7,G	KEY WAY	
RJ11 J2 Pin No	RJ11 J3 Pin No	
3	3	RS-485 (DX-)
4	4	RS-485 (DX+)

#### PDC Ordering Code: KX

Description: G1 base I/O with 7003298 adapter for compatibility with Unit UDK15

Pin No	Signals	
3	VALVE CONTROL	
2	OUTPUT (0-5 VDC)	
7	+15 VDC	+24 VDC
5	PWR COM	NC
6	-15 VDC	PWR COM
8	SETPOINT (0-5 VDC)	
11,12	SIGNAL COMMON	
15	CASE GROUND	
1, 4, 9, 10, 13, 14	NO CONNECTION	

#### PDC Ordering Code: BX

Description: G1 base I/O with 7003590 adapter for compatibility with Brooks 15-Pin D

Pin No	Signals	
12	VALVE OVERRIDE	
2	OUTPUT (0-5 VDC)	
5	+15 VDC	+24 VDC
9	PWR COM	NC
6	-15 VDC	PWR COM
8	SETPOINT (0-5 VDC)	
1,10	SIGNAL COMMON	
3,4,7,11	NO CONNECTION	
13,14,15	NO CONNECTION	

Other adapter options are available for the GF Series. Please contact Brooks Customer Service for more information.

# Product Dimensions

## Downport Configurations

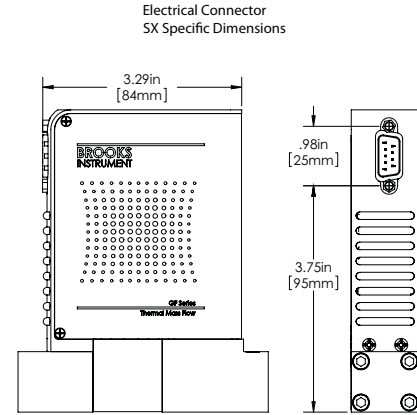
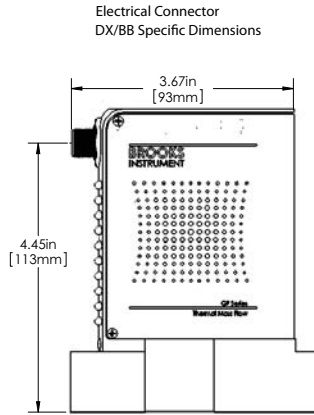
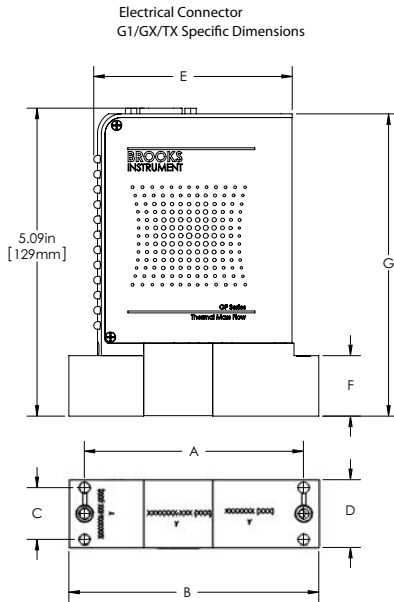

Fitting Option Code	Seal Type	Dim A	Dim B	Dim C	Dim D	Dim E	Dim F	Dim G
CX	C-SEAL	92mm [3.62in]	105mm [4.13in]	22mm [0.86in]	28mm [1.12in]	83mm [3.28in]	25mm [1.00in]	127mm [5.00in]
EX	W-SEAL	79.8mm [3.14in]	93mm [3.66in]	30mm [1.18in]	39mm [1.53in]	72mm [2.82in]	25mm [1.00in]	127mm [5.00in]
WX	W-SEAL	92mm [3.62in]	105mm [4.13in]	22mm [0.86in]	28mm [1.12in]	83mm [3.28in]	25mm [1.00in]	127mm [5.00in]
DX	C-SEAL	79.8mm [3.14in]	93mm [3.66in]	22mm [0.86in]	28mm [1.12in]	72mm [2.82in]	25mm [1.00in]	127mm [5.00in]
YX	W-SEAL	79.8mm [3.14in]	93mm [3.66in]	22mm [0.86in]	28mm [1.12in]	72mm [2.82in]	25mm [1.00in]	127mm [5.00in]
AX	C-SEAL	92mm [3.62in]	105mm [4.13in]	30mm [1.18in]	39mm [1.53in]	83mm [3.28in]	25mm [1.00in]	127mm [5.00in]
BX	W-SEAL	92mm [3.62in]	105mm [4.13in]	30mm [1.18in]	39mm [1.53in]	83mm [3.28in]	25mm [1.00in]	127mm [5.00in]
LX	C-SEAL	92mm [3.62in]	105mm [4.13in]	22mm [0.86in]	28mm [1.12in]	83mm [3.28in]	25mm [1.00in]	127mm [5.00in]

# Product Dimensions (continued)

## VCR Configurations

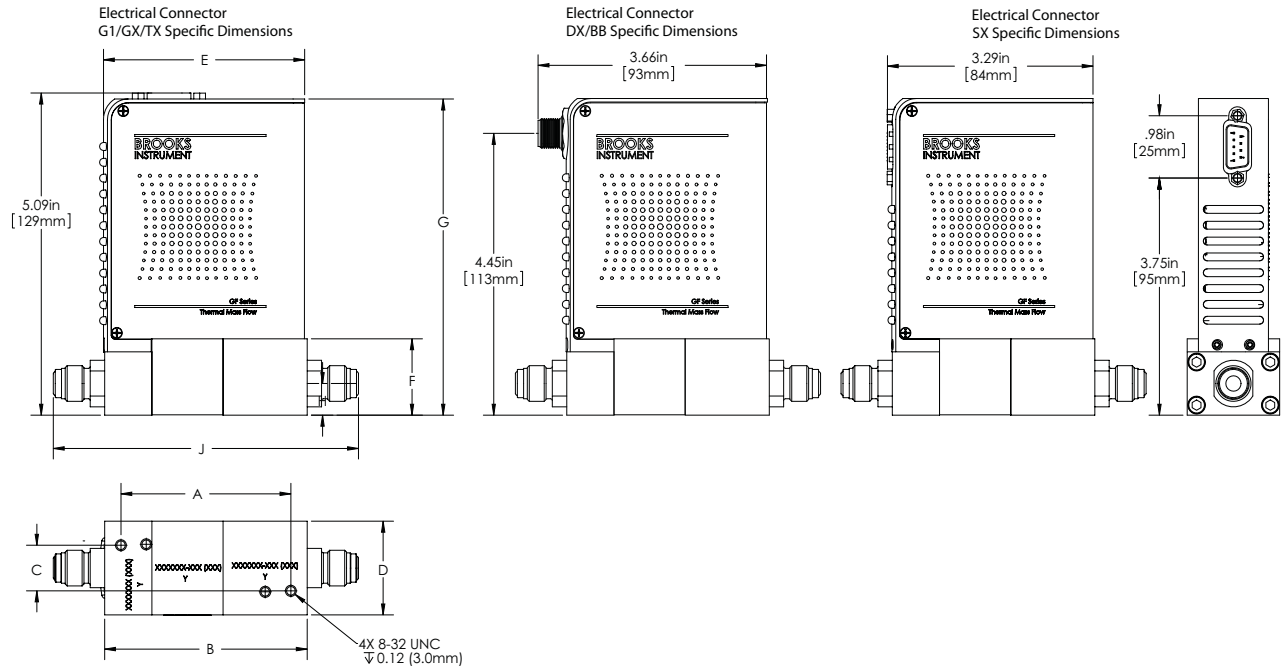

Fitting Option Code	VCR	Dim A	Dim B	Dim C	Dim D	Dim E	Dim F	Dim G	Dim H	Dim J
VX	1/4"	69mm [2.72in]	82mm [3.24in]	18mm [0.72in]	38mm [1.48in]	83mm [3.28in]	31mm [1.21in]	127mm [5.0in]	13mm [0.50in]	124mm [4.88in]

## Model Code

Code Description	Code Option	Option Description
<b>I.</b> Base Model Code	<b>GF</b>	High Purity/Ultra High Purity Digital Mass Flow Controllers
<b>II.</b> Package / Finish Specifications	<b>100</b>	Flow range 3 sccm -55 slpm N <sub>2</sub> Eq.; ± 1.0% SP Accuracy; 1 sec Response; 10 Ra
	<b>120</b>	Flow range 3 sccm -55 slpm N <sub>2</sub> Eq.; + 1.0% SP Accuracy; 700 msec Response; 4 Ra
	<b>125</b>	Pressure Transient Insensitive (PTI) Flow range 3 sccm -55 slpm N <sub>2</sub> Eq.; + 1.0% SP Accuracy; 300-700 msec Response; 4 Ra
<b>III.</b> Configurability	<b>C</b>	MultiFlo capable. Standard bins or specific gas/range may be selected.
	<b>X</b>	Not MultiFlo capable. Specific gas/range required. (must select w/ SD, SL or HA special application)
<b>IV.</b> Special Application	<b>XX</b>	Standard
	<b>HA</b>	High Accuracy Calibration; (GF125 only)
	<b>SL</b>	Safe Delivery System (GF120 Only) Full scale flow range; 4 to 25 sccm, Nitrogen Equivalent
	<b>SD</b>	Safe Delivery System (GF120 Only) Full scale flow range; >25 sccm to 1 slpm, Nitrogen Equivalent
<b>V.</b> Valve Configuration	<b>O</b>	Normally Open valve (not available with SD, SL or HA options)
	<b>C</b>	Normally Closed valve (must select with SD, SL or HA special application)
	<b>M</b>	Meter (No Valve)
<b>VI.</b> Gas or SH MultiFlo Bin	<b>XXXX XXXX</b>	Specific Gas Code & Range, i.e. "0004" = Argon and "010L" = 10 slpm (must select w/ SD, SL or HA special application).
	<b>SH40 010C</b>	Standard Configuration #40, 3-10 sccm Nitrogen Equivalent (0° C Reference)
	<b>SH41 030C</b>	Standard Configuration #41, 11-30 sccm Nitrogen Equivalent (0° C Reference)
	<b>SH42 092C</b>	Standard Configuration #42, 31-92 sccm Nitrogen Equivalent (0° C Reference)
	<b>SH43 280C</b>	Standard Configuration #43, 93-280 sccm Nitrogen Equivalent (0° C Reference)
	<b>SH44 860C</b>	Standard Configuration #44, 281-860 sccm Nitrogen Equivalent (0° C Reference)
	<b>SH45 2.6L</b>	Standard Configuration #45, 861-2600 sccm Nitrogen Equivalent (0° C Reference)
	<b>SH46 7.2L</b>	Standard Configuration #46, 2601-7200 sccm Nitrogen Equivalent (0° C Reference)
	<b>SH47 015L</b>	Standard Configuration #47, 7201-15000 sccm Nitrogen Equivalent (0° C Reference)
	<b>SH48 030L</b>	Standard Configuration #48, 15001-30000 sccm Nitrogen Equivalent (0° C Reference)
	<b>SH49 040L</b>	Standard Configuration #49, 30001-40000 sccm Nitrogen Equivalent (0° C Reference)
<b>SH50 055L</b>	Standard Configuration #50, 40001-55000 sccm Nitrogen Equivalent (0° C Reference)	
<b>VII.</b> Fitting	<b>VX</b>	1-1/2" body width, 124mm 1/4" VCR male
	<b>CX</b>	1-1/8" body width, 92mm C Seal
	<b>DX</b>	1-1/8" body width, 79.8mm C Seal
	<b>EX</b>	1-1/2" body width, 79.8mm W Seal
	<b>WX</b>	1-1/8" body width, 92mm W Seal
	<b>YX</b>	1-1/8" body width, 79.8mm W Seal
	<b>AX</b>	1-1/2" body width, 92mm C Seal
	<b>BX</b>	1-1/2" body width, 92mm W Seal
	<b>LX</b>	1-1/8" body width, 92mm C Seal w/Poke Yoke
	<b>AS</b>	1-1/2" body width, 92mm 0.440" large bore C Seal (only for bins SH45-SH50)
<b>VIII.</b> Downstream Condition	<b>A</b>	Atmosphere
	<b>V</b>	Vacuum; Default for SD, SL and HA special application
<b>IX.</b> Sensor	<b>O</b>	Default Sensor Orientation

## Model Code (continued)

Code Description	Code Option	Option Description									
X. Connector	<b>BX</b>	Cable adapter to 15 pin D Brooks (Unit "B", "N") adapts G1 base									
	<b>EX</b>	Cable adapter to Card Edge (w/out VTP), RS485 through RJ11 jacks (Unit "E"; IN "L", "R") adapts GX base									
	<b>FX</b>	Cable adapter with 9 pin STEC pin-out & jack screws (w/VTP) (Unit "F", "O") adapts SX base									
	<b>GX</b>	9-Pin D with RS485 (Unit "G"); display and overlay 180° orientation									
	<b>G1</b>	9-Pin D with RS485 (Unit "G")									
	<b>JX</b>	Cable adapter with 9 pin STEC pin-out & jack screws (w/VTP) (Unit "J", "W") adapts SX base									
	<b>KX</b>	Cable adapter to MKS 15-Pin D (Unit "K") adapts G1 base									
	<b>SX</b>	9 pin D with STEC pin-out (w/VTP) (Unit "S", "Q")									
	<b>TX</b>	9 pin D with UDT9 pin-out (UDT9)									
	<b>T1</b>	Cable adapter to 15 pin D (IFlow DB15 & TN 15 pin) adapts TX base									
	<b>UX</b>	Cable adapter to 15 pin D (w/VTP) (Unit & TN "U") adapts SX base									
	<b>BB</b>	DeviceNet™ Analog (Not Available on 79.8mm fitting DX, YX, EX)									
	DeviceNet Standard Configuration Parameters										
		I/O	Connector	Power On State	Full Scale Setting	Full Scale Setting	Full Scale Setting	Poll IO Instance Producer	Poll IO Instance Consumer	Poll IO State Transition	External Baud Rate
	<b>D0</b>	DeviceNet	5 Pin Micro	Idle	Count	Integer	6000h	2	7	Executing	500KB
	<b>D1</b>	DeviceNet	5 Pin Micro	Idle	Count	Integer	6000h	21	7	Executing	500KB
	<b>D2</b>	DeviceNet	5 Pin Micro	Idle	SCCM	Float	7FFFh	13	19	Executing	500KB
	<b>D3</b>	DeviceNet	5 Pin Micro	Idle	Count	Integer	6000h	22	7	Executing	500KB
	<b>D4</b>	DeviceNet	5 Pin Micro	Executing	Count	Integer	6000h	22	8	Executing	500KB
	<b>D5</b>	DeviceNet	5 Pin Micro	Idle	Count	Integer	6000h	6	8	Executing	500KB
<b>D6</b>	DeviceNet	5 Pin Micro	Idle	Count	Integer	7FFFh	3	7	Executing	500KB	
<b>D7</b>	DeviceNet	5 Pin Micro	Idle	Count	Integer	7FFFh	6	8	Executing	500KB	
<b>D8</b>	DeviceNet	5 Pin Micro	Idle	Count	Integer	6000h	3	7	Executing	500KB	
<b>D9</b>	DeviceNet	5 Pin Micro	Executing	Count	Integer	6000h	2	7	Executing	500KB	
<b>DA</b>	DeviceNet	5 Pin Micro	Idle	Count	Integer	7FFFh	22	7	Executing	500KB	
<b>DB</b>	DeviceNet	5 Pin Micro	Idle	Count	Integer	6000h	22	8	Executing	500KB	
<b>DC</b>	DeviceNet	5 Pin Micro	Idle	Count	Integer	7FFFh	3	7	Idle	500KB	
<b>DD</b>	DeviceNet	5 Pin Micro	Executing	Count	Integer	7FFFh	22	8	Executing	500KB	
<b>DE</b>	DeviceNet	5 Pin Micro	Executing	Sccm	Float	6000h	15	19	Executing	500KB	
<b>DX</b>	DeviceNet	5 Pin Micro	To be defined by CSR								

Code Description	Code Option	Option Description
XI. Customer Special Request	<b>XXXX</b>	Customer Special Request Number; required with "DX, BB" Conn. Option to define DNet settings
XII. Auto Shut-Off	<b>A</b>	Auto Shut-Off (Included) Default for SD and SL special application
	<b>X</b>	Auto Shut-Off (Not Included) (Must be selected for meter)
XIII. Auto Zero	<b>A</b>	Auto Zero (Included)
	<b>X</b>	Auto Zero (Not Included)
XIV. Reference Temperature	<b>000</b>	0°C Reference Calibration (Standard) - Default Setting

### Sample Standard Model Code

I	II	III	IV	V	VI	VII	VIII	IX	X	XI	XII	XIII	XIV
GF	100	C	XX	M	- SH40010C	- VX	A	0	GX	- XXXX	A	X	- 000

### Sample High Accuracy (HA) Model Code

I	II	III	IV	V	VI	VII	VIII	IX	X	XI	XII	XIII	XIV
GF	125	X	HA	C	- XXXXXXXX	- CX	V	0	FX	- XXXX	A	X	- 000

### Sample Safe Delivery System (SDS) Model Code

I	II	III	IV	V	VI	VII	VIII	IX	X	XI	XII	XIII	XIV
GF	120	X	SD	C	- XXXXXXXX	- EX	V	0	SX	- XXXX	A	X	- 000

## Brooks Service and Support

Brooks is committed to assuring all of our customers receive the ideal flow solution for their application, along with outstanding service and support to back it up. We operate first class repair facilities located around the world to provide rapid response and support. Each location utilizes primary standard calibration equipment to ensure accuracy and reliability for repairs and recalibration and is certified by our local Weights and Measures Authorities and traceable to the relevant International Standards.

Visit [www.BrooksInstrument.com](http://www.BrooksInstrument.com) to locate the service location nearest to you.

### START-UP SERVICE AND IN-SITU CALIBRATION

Brooks Instrument can provide start-up service prior to operation when required. For some process applications, where ISO-9001 Quality Certification is important, it is mandatory to verify and/or (re)calibrate the products periodically. In many cases this service can be provided under in-situ conditions, and the results will be traceable to the relevant international quality standards.

### CUSTOMER SEMINARS AND TRAINING

Brooks Instrument can provide customer seminars and dedicated training to engineers, end users, and maintenance persons.

Please contact your nearest sales representative for more details.

### HELP DESK

In case you need technical assistance:

USA	☎ 888 275 8946	Taiwan	☎ +886 3 5590 988
Europe	☎ +49 351 215 2040	China	☎ +86 21 5079 8828
Japan	☎ +81 3 5633 7100	Singapore	☎ +6297 9741
Korea	☎ +82 31 708 2521		

Due to Brooks Instrument's commitment to continuous improvement of our products, all specifications are subject to change without notice.

### TRADEMARKS

Brooks .....	Brooks Instrument, LLC
DeviceNet .....	Open DeviceNet Vendors Association, Inc.
Hastelloy .....	Haynes International
MultiFlo .....	Brooks Instrument, LLC
SDS .....	Matheson Tri-Gas and ATMI, Inc.
VCR .....	Cajon Co.



**Brooks Instrument**  
407 West Vine Street  
P.O. Box 903  
Hatfield, PA 19440-0903 USA  
T (215) 362 3700  
F (215) 362 3745  
E-Mail [BrooksAm@BrooksInstrument.com](mailto:BrooksAm@BrooksInstrument.com)  
[www.BrooksInstrument.com](http://www.BrooksInstrument.com)

**Brooks Instrument**  
Neonstraat 3  
6718 WX Ede, Netherlands  
T +31 (0) 318 549 300  
F +31 (0) 318 549 309  
E-Mail [BrooksEu@BrooksInstrument.com](mailto:BrooksEu@BrooksInstrument.com)

**Brooks Instrument**  
1-4-4 Kitasuna Koto-Ku  
Tokyo, 136-0073 Japan  
T +81 (0) 3 5633 7100  
F +81 (0) 3 5633 7101  
E-Mail [BrooksAs@BrooksInstrument.com](mailto:BrooksAs@BrooksInstrument.com)