

NASA TM-2002-0819

AIAA-2002-0819

Atmospheric Flight on Venus

Geoffrey A. Landis
NASA John Glenn Research Center
Cleveland, OH

Christopher LaMarre
University of Illinois
Champaign, IL

Anthony Colozza
Northland Scientific
Cleveland, OH

40th Aerospace Sciences Meeting & Exhibit
14-17 January 2002
Reno Nevada

ATMOSPHERIC FLIGHT ON VENUS

Geoffrey A. Landis¹

NASA John Glenn Research Center
Mailstop 302-1
21000 Brookpark Road
Cleveland, OH 44135

Anthony Colozza

Northland Scientific
NASA John Glenn Research Center
Mailstop 301-3
21000 Brookpark Road
Cleveland, OH 44135

Christopher M. LaMarre

University of Illinois
Dept. Aeronautical Engineering
Champaign, IL 61820

ABSTRACT

We propose a solar-powered aircraft system for the exploration of Venus. The atmosphere of Venus provides several advantages for flying a solar-powered aircraft. At the top of the cloud level, the solar intensity is comparable to or greater than terrestrial solar intensities. The atmospheric pressure makes flight much easier than on planets such as Mars. Also, the slow rotation of Venus allows an airplane to be designed for flight within continuous sunlight, eliminating the need for energy storage for nighttime flight. These factors make Venus a prime choice for a long-duration solar-powered aircraft. Fleets of solar-powered aircraft could provide an architecture for efficient and low-cost comprehensive coverage for a variety of scientific missions.

INTRODUCTION

With the success of missions such as the Mars Pathfinder, exploration of the planet Mars has received a large amount of public attention, and has recently been suggested as an environment for flying a powered aircraft. Venus, Earth's evil twin, is also an extremely interesting planet, but far less studied. Because of a white cloud cover that reflects most of the incident solar radiation back into space, the planet Venus actually absorbs less energy from the sun than the Earth, despite its orbital position 27% closer to the sun.

Venus is nearly the same size as the Earth, but utterly unlike the Earth [1,2]. Due to a runaway greenhouse effect, the temperature of the surface is nearly 500° C.

¹ *Engineer, Photovoltaics and Space Environmental Effects Branch, NASA John Glenn Research Center. Associate fellow, AIAA

Copyright ©2002 by the American Institute of Aeronautics and Astronautics, Inc. No copyright is asserted in the United States under Title 17, U. A. Code. The U. S. Government has a royalty-free license to exercise all rights under the copyright claimed herein for Government purposes. All other rights are reserved by the copyright holder.

Use of a solar powered aircraft for exploration of Venus was recently proposed by Landis [3]. The Venus atmosphere is a favorable environment for flying powered aircraft. The atmospheric pressure makes flight much easier than on planets such as Mars. Solar power is abundant; at the top of the cloud level, the solar intensity is comparable to or greater than terrestrial solar intensities, and the slow rotation of Venus allows an airplane to be designed for flight within continuous sunlight, eliminating the need for energy storage for nighttime flight. These factors make Venus a prime choice for a long-duration solar-powered aircraft.

In 1985, the Russian space agency successfully deployed a balloon mission, VEGA, in the atmosphere of Venus [2], but airplanes have not previously been developed for Venus. An aircraft, with the ability to control its position in the atmosphere of Venus instead of drifting with the wind, would be a powerful tool for scientific exploration.

Figure 1 shows an artist's conception of a small solar-powered airplane flying above the cloud layer of Venus.

VENUS

With a period of 243 days, the planet Venus has the slowest rotation of any planet in the solar system. This slow rotation results in a very long solar day, of duration 117 (Earth) days. This means that the ground speed required for an airplane to remain at the subsolar point is extremely slow, only 13.4 km/hr at the equator. In the Venus environment, it may be possible to maintain flight within the sunlit portion of the planet continuously. This possibility of continuous sunlight makes Venus extremely attractive for a solar-powered aircraft.

Figure 2 shows the atmospheric pressure on Venus as a function of altitude above the surface [2,3]. The altitude where terrestrial aircraft operate, between sea level and 24 km, corresponds to atmospheric pressure from one bar to 30 millibar. On Venus, this pressure range is found from 50 km to 75 km above the surface. At these flight altitudes, the temperature varies from 80 °C at 45 km, decreasing to -10 to -35 °C at 60 km. Averaged temperature, pressure, and density data on the atmosphere is given as a function of altitude in table 1.

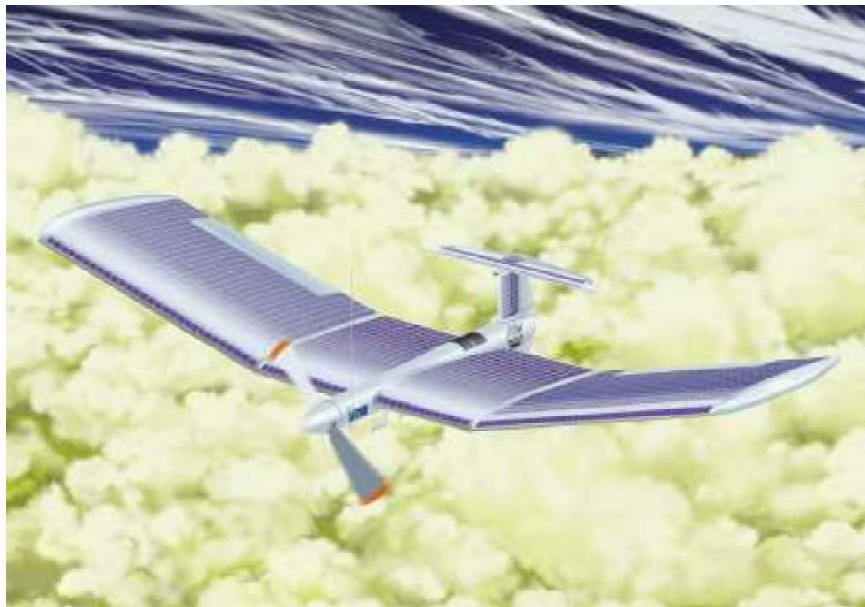

Figure 1. Concept for a Venus Airplane Design

The acceleration due to gravity on Venus is 8.87 m/s², slightly lower than that of Earth, making Venus a slightly easier planet for powered flight.

Above the clouds, solar energy is available in abundance on Venus. Venus has a solar flux of 2600 W/m², compared to Earth's 1370 W/m². Figure 3 (adapted from reference [4], see also figure 3 of [5]) shows the altitude variation of the intensity of the downward solar radiation (expressed as a fraction of the solar intensity above the atmosphere) as measured by the Venera-11 probe during descent. The solar intensity is 20 to 50% of the exoatmospheric intensity (depending on wavelength) at the bottom of the cloud layer at 50 km, and increases to nearly 95% of the exoatmospheric intensity at 65 km, the top of the main cloud layer. The bottom of the cloud layer is clearly seen by the leveling out of solar intensity.

The atmosphere between 50 km and 75 km on Venus is one of the most dynamic and interesting regions of the planet. The challenge for a Venus aircraft will be the fierce winds and caustic atmosphere.

The winds peak at about 95m/s at the cloud top level. In order to remain on the sunlit side of Venus, an exploration aircraft will have to be

capable of sustained flight at or above the wind speed.

The cloud layer extends from about 45-50 km altitude to roughly 64 km. Clouds are composed of sulfuric acid, free sulfur and trace contaminants such as HF, HCl, CO and H₂O [1,2]. There is also significant ultraviolet at the higher altitudes that can accelerate degradation through photochemistry. By any measure, this is an extremely acidic and hazardous environment for machinery and electrical systems. Nevertheless, materials are available that easily withstand the sulfuric acid environment, and assuming that the design avoids exposed metal on the surface, an aircraft should be able to be engineered to withstand the environment.

A Venus aircraft must also contend with violent weather conditions. The region just above the cloud tops experiences a phenomenon known as "super-rotation" where the atmosphere circles the planet every 4 days, traveling in excess of 200 mph [1]. The cloud system also may experience high vertical wind shear. A solar-powered aircraft will also have to contend with decreasing power as it descends into the clouds. The combination of a caustic atmosphere and hurricane force wind makes aircraft design and control challenging.

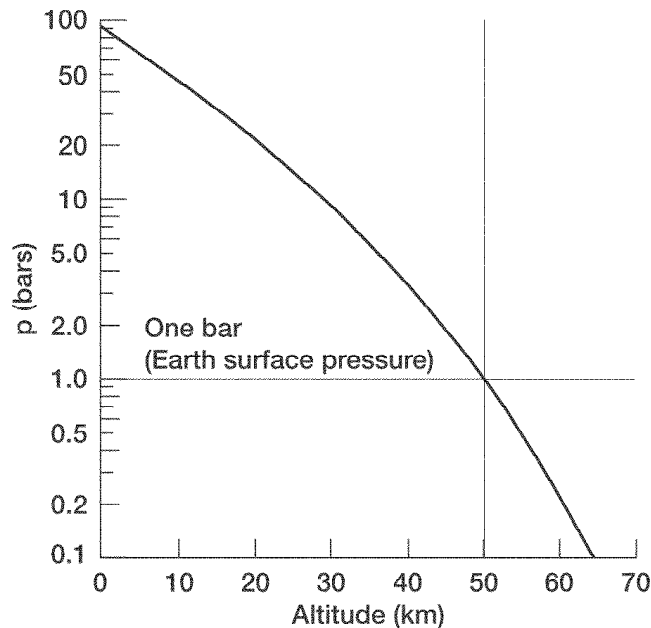

Figure 2. Atmospheric pressure (horizontal axis) in bars as a function of altitude (vertical axis) in the Venus atmosphere. The vertical line is at one bar (100 kPa), the terrestrial surface pressure. (Figure from Seiff [6], showing data from Venera 8-12 and Pioneer Venus missions).

H (km)	T (K)	P (bar)	ρ (kg/m ³)
0	735	92.10	64.79
5	697	66.65	49.87
10	658	47.39	37.72
15	621	33.04	27.95
20	581	22.52	20.39
25	539	14.93	14.57
30	497	9.851	10.15
35	455	5.917	6.831
40	418	3.501	4.404
45	385	1.979	2.693
50	350	1.066	1.594
55	302	0.5314	0.9207
60	263	0.2357	0.4694
65	243	0.09765	0.2086
70	230	0.03690	0.08393
75	215	0.01363	0.03298
80	197	0.004760	0.01186
85	181	0.001393	0.004007
90	169	0.0003736	0.001151
95	168	0.0001016	0.0003155
100	175	0.00002660	0.00007890

Table 1: Temperature, pressure, and density of the Venus atmosphere as a function of altitude above the surface

SMALL VENUS AIRCRAFT: FOLDING

Realistic planetary missions in the current decade must have low cost and minimum complexity. In order to minimize the cost, the baseline design for a Venus aircraft is sized to fit within the aeroshell of the Pioneer-Venus small atmospheric probe. This mission successfully deployed three small probes and one large probe into the Venus atmosphere in 1978. Designing to this constraint has three advantages:

1. Entry vehicle design heritage has already been proven to work in the Venus atmosphere
2. The vehicle size is appropriate to launch on a small "Discovery" class launch vehicle (*i.e.*, a Delta).
3. The use of a small aircraft allows a mission design to deploy a fleet of aircraft simultaneously, allowing simultaneous measurements of separated areas of the

atmosphere (and also providing some vehicle redundancy).

4. Choice of the small aeroshell allows fall-back to the Pioneer-Venus large aeroshell in the event of "design creep" resulting in requirement of larger entry vehicle.

The disadvantage of using the small aeroshell is that the resulting vehicle, sized to fit inside a 1.3 meter aeroshell (usable diameter 1.2 meters), is extremely small. The small aircraft baseline design is for a 10 kilogram vehicle, with a wing area of approximately two square meters. This size is similar to the size of model aircraft, as well as the size of military Unpiloted Aerial Vehicles (UAVs) such as the Marine "Dragon Eye" UAV.

Large aircraft are more efficient than small ones. If an aircraft of 1-2 square meter wing area can be shown to be feasible, then larger aircraft will be not merely possible, but easy. Thus, by analyzing the more difficult small aircraft design, we can demonstrate the possibility of powered aircraft of all sizes.

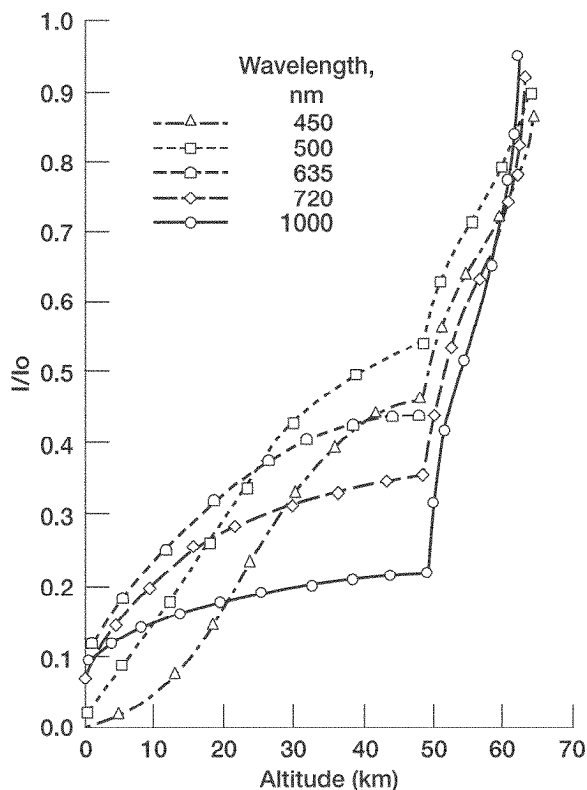

Figure 3. Solar intensity at different wavelengths as a function of altitude in the Venus atmosphere, shown as fraction of the exoatmospheric solar flux I_0 . (from Fimmel, Colin and Burgess [4], showing data from Venera 11 mission [5]). Average solar flux I_0 is 2600 W/m^2 .

Figure 4 shows the size of the small atmospheric probe of the Pioneer Venus mission [4], and the available area inside. There are a number of potential methods of conforming the aircraft to fit within the standard shape of an entry capsule (or "aeroshell"). The simplest concept is to fold the aircraft at one or more wing joints, and possibly along the body or tail boom. Alternate approaches that could provide greater packing factor include utilizing an inflatable, self-rigidizing structure for the wing or fuselage.

For reliability, it is desirable that the number of moving parts be minimized. Figure 5 shows a concept for a Venus airplane design that requires only two folds to fold the wing into an aeroshell, and no folds to deploy the tail. (An artist's conception of the aircraft after unfolding is shown in figure 1.)

Because of the design constraint that the two-fold wing is to fit into a 1.2-meter interior diameter of the small aeroshell, the wing area is maximum at extremely low aspect ratio, and higher aspect ratios can be achieved only by reducing the wing area. Table 2 shows the trade-off between wing area and

aspect ratio. To fit the circular aeroshell, the resulting design trade-off increases wing area by accepting the design compromise of an extremely short tail moment and small tail area (stabilizer area 9% of wing area). In terms of flight behavior, the aircraft is essentially a flying wing design with the addition of a small control surface.

Wing		Tail	
Area (m ²)	AR	horizontal area (m ²)	vertical area (m ²)
1.05	11.62	0.05	0.03
1.36	8.49	0.09	0.04
1.64	6.55	0.14	0.04
1.87	5.20	0.19	0.05
2.05	4.18	0.24	0.05
2.15	3.35	0.29	0.05

Table 2. Trade-off between wing area and aspect ratio for airplane sized to fit inside Pioneer Venus small-probe aeroshell.

A more conventional aircraft design can be made by folding or telescoping the tail boom as well as the wing.

Upon entry into the atmosphere, the aeroshell decelerates, followed by parachute deployment and slowing to a speed that would allow for unfolding of the aircraft. This deceleration and parachute deployment sequence follows the Pioneer Venus mission profile. Once the capsule has been decelerated to an acceptable speed, the aeroshell is discarded and the aircraft unfolds and begins flight.

The stowage, atmospheric capture and deployment mechanisms chosen will greatly influence the design and capabilities of the aircraft. This aspect of the aircraft is critical to its overall reliability and operation, and needs to be addressed from the initial stages of the development. The structure of the aircraft will need to be as light as possible, to enhance flight performance and to reduce launch and orbital transfer costs.

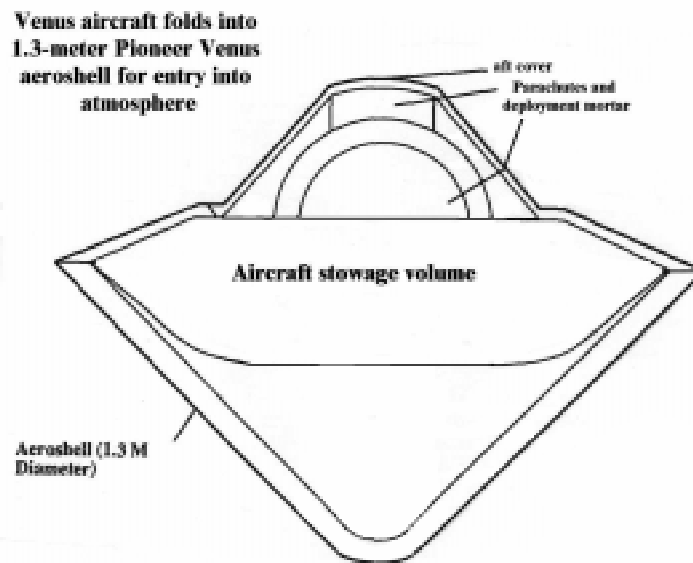

Figure 4 Available aircraft storage volume for aircraft sized to fit in the 1.3-meter Pioneer Venus small aeroshell (From Fimmel, Colin and Burgess [4]).

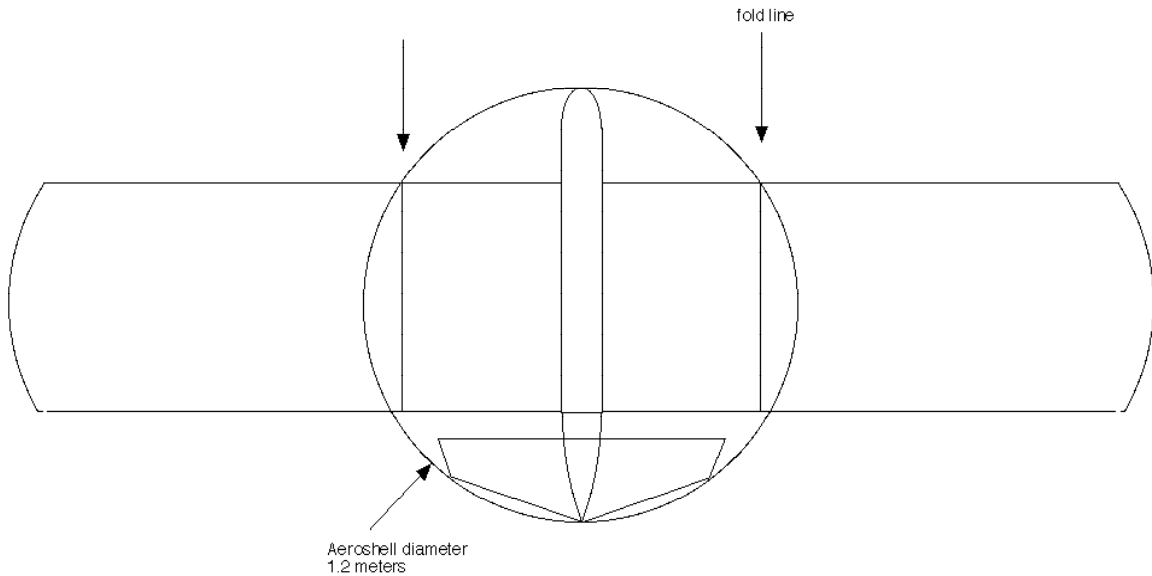

Figure 5 . Two-hinge fold pattern for small aircraft sized to fit inside Pioneer Venus small-probe aeroshell [3].

AIRCRAFT DESIGN AND ANALYSIS

Two aircraft designs were analyzed.

The "small" aircraft design is similar to that shown in figures 1 and 5. The baseline parameters are shown in table 3. The baseline small airplane is 3 m wing span, 1.2 m² wing area, and 10 kg mass. A chord of 0.4 meters was chosen to allow room for a small tail. This gave this configuration an aspect ratio of 7.5. The horizontal tail has a surface area of 0.12 m², and span of 0.6 m, giving a tail volume coefficient of 0.12. The vertical tail was sized at half the surface area of the horizontal, at the same tail moment arm, with a span of 0.3 m. This gives a volume coefficient of 0.008. Both of the volume coefficients are low by conventional standards, so a stability and control calculation was performed to see if the control surfaces would be able to maneuver the aircraft.

Wing area	1.2 m ²
Aspect ratio	7.5
Span	3 m
Wing chord	0.4 m
Total mass	10 kg

Table 3: "small" Venus aircraft design parameters

Wing area	1.6 m ²
Aspect ratio	12.
Span	4.38 m
Wing chord	0.37 m
Total mass	15 kg

Table 4: "large" Venus aircraft design parameters

For comparison, the "large" aircraft is a more conventional design, chosen to simplify calculations and so that the aircraft would be able to be compared to historical data. Table 4 shows the design parameters, and the aircraft is shown in figure 6. The aircraft was sized to fit a 1.5 m aeroshell. The aircraft has a mass of 15 kg, wing area of 1.6 m², and a span of 4.38 m. The tail moment arm of the aircraft was set at 3.5 or 1.3 meters, which would allow the tail to be as long as possible, but also fit into the aeroshell with only one fold. The horizontal tail area is 0.32m² and the vertical tail area 0.22 m². The control surfaces on both the horizontal and the vertical were taken as 25% of the chord.

Typical flight altitudes for analysis were 65 to 75 km above the surface. At these altitudes, the aircraft will be flying at a Reynolds number of approximately 200,000. A high-performance sailplane airfoil, the SG8000, was used on the "large" design. Due to the small tail on the "small"

design, the airfoil MH45, a low pitching-moment airfoil that performs well at the flight Reynolds numbers, was chosen. The lift and drag slopes for these airfoils were calculated based on data from the UIUC airfoil database site.

The skin friction drag on the other parts of the aircraft was estimated using the approach of McCormick [6]. The dimensions of the tail surfaces and fuselage were used to calculate the Reynolds number of each structure. A Reynolds number of 300,000 was used for the transition of laminar to turbulent flow.

The power analysis follows methods similar to those used by Colozza [8] for Mars aircraft, and McCready [9] for solar-powered terrestrial aircraft.

Propeller efficiencies were determined from a computer code that uses momentum theory to analyze the propeller [10]. This code inputs the density, propeller diameter, and number of blades and generates efficiencies and thrusts for different blade angles for blades with a Clark Y airfoil. The code steps through a series of advance ratios and blade angles. By inputting different altitudes, and therefore different densities, the propeller's thrust levels and speed of revolution is adjusted. It was possible to design propellers that would provide enough thrust to work over the desired Venus altitude range. The propeller efficiency at the various altitudes and speeds was then input into the power available equation. For simplicity, the propeller efficiency was assumed to remain constant at a given altitude; for the range of altitudes considered, the velocities for a given efficiency changed by less than two percent. A 3-bladed propeller 1.1 m in diameter was chosen for the designs.

(If the flight regime was limited to an even narrower altitude and speed range, a more efficient propeller could be chosen specifically for that mission.)

The electric motor selected for the designs is capable of producing the needed RPM and torque for this propeller if a gear box is utilized.

Power was assumed to be provided by solar cells, with an assumed conversion efficiency of 20% at 25C, which is an extremely conservative efficiency, easily found in commercially available cells [11]. Cell temperature coefficients from reference [12] were used to adjust the actual performance to flight temperature at altitude. Cells were assumed to be on both top and bottom wing

surfaces, where the bottom-mounted cells collected reflected light, assuming an albedo of 0.7. The solar cell coverage was assumed to be 80% of the wing area.

The propeller, power converter, and electronics were assumed to have energy efficiencies of $\eta_{\text{propeller}} = 0.85$, $\eta_{\text{electronics}} = 0.9$, and $\eta_{\text{converter}} = 0.9$ respectively. Including these factors, the net energy conversion efficiency produced was 13.8 percent.

The airframe mass estimation method came from Stender [13]. These airframe mass was then added to component masses to obtain a total aircraft mass (Table 5).

Component	Mass (kg)
gearbox	0.22
motor	0.22
speed controller	0.085
Auto-pilot	0.113
data storage	0.5
aileron servo	0.071
aileron servo	0.071
charger	0.2
batteries	1.27
tail servo	0.08
tail servo	0.08
daylight camera	0.026
infrared camera	0.02
communications	0.5
other payload	1.5
solar cells	0.8
wing	5.16
fuse	1.44
motor bulkhead	0.0248
center bulkhead	0.0558
rear bulkhead	0.0558
H-tail	0.64
V-tail	0.64
propeller	0.4
total mass	14.17

Table 5: Component mass breakdown for large design

The motors, speed controllers, and actuators are model aircraft components. The cameras are from a military UAV design. Other components such as the data storage and communications package are estimates. Battery mass was based on a requirement to be able to keep the aircraft in level flight for 10 minutes with no solar input in case of emergency. The large aircraft is sized to carry visual and infrared cameras, and 1.5 kg of scientific payload.

The power required for level flight, P_{flight} , is

$$P_{\text{flight}} = \frac{1}{2} \rho f V^3 + \frac{2(W/b)^2}{(\pi \rho e V)} \quad (1)$$

where ρ is the density, f the skin friction coefficient, V the velocity, W the weight, b the wingspan, and e the Oswald's efficiency factor. An e of 0.8, as suggested by McCormick for a high-wing airplane [7], and an f of $0.0117 \cdot S$, as suggested by Colozza [9], were used for this calculation.

The power required for level flight was calculated as a function of flight speed, and compared with the available solar energy provided by the solar cells. The minimum and maximum speed of the flight envelope are set at the points where the required power exactly equals the available solar power.

Figure 7 shows an example calculation of power required for level flight as a function of flight speed, for the large plane flying at 70 km altitude. The flight speed envelope is about 47 to 96 meters per second.

Figure 8 shows an example calculation of the effect of aspect ratio on the performance of the "small" airplane design. Due to the constraint of fitting into the aeroshell, as shown in table 2, the lower aspect ratio airplanes have larger wing area, and hence more solar power available, but also have lower aerodynamic efficiency, and hence require more power for flight. This calculation is shown for a flight altitude of 66 km, slightly above the top of the cloud layer. As can be seen, the power available from the solar array on the wing

equals the power required for flight at a maximum flight speed of about 78 m/sec, and this value is nearly independent of aspect ratio. The higher solar power available for low aspect ratio/large wing area is nearly canceled by the disadvantage of higher power required, and there is no clear optimum for the aspect ratio/wing area trade-off.

The maximum flight speed values are then compared to the wind velocity. For values where the envelope of flight speed is higher than the wind velocity, it is possible for the aircraft to "stationkeep" at the subsolar point, allowing flight duration of indefinite length.

For both aircraft, the minimum flight altitude for remaining stationary at the subsolar point was about 70 km. Below this altitude the combination of higher atmospheric density, lower solar energy, higher temperature (and hence lower solar cell performance), and high wind speed made it not possible for this design to indefinitely remain stationary at the subsolar point.

For exploration of lower altitudes, it is feasible to glide down to low altitudes for periods of several hours, accepting the fact that the airplane ground track will blow downwind, and then climb back to higher altitudes and fly upwind to the original point, allowing both high and low altitudes to be probed.

Analysis of flight using battery storage shows that it is not feasible to keep the aircraft aloft on battery power alone during the passage across the night side of the planet. Likewise, the unpowered glide range of the aircraft is not high enough for it to glide around the night side of the planet and re-emerge into sunlight. Therefore, if the mission duration is to be unlimited, the mission is restricted to the daylight side of the planet, and to altitudes high enough that the aircraft can equal or exceed the wind speed.

An alternate technique might be to mount solar arrays on the vertical surfaces of the airplane, and to fly in near-polar latitudes. This approach was not examined.

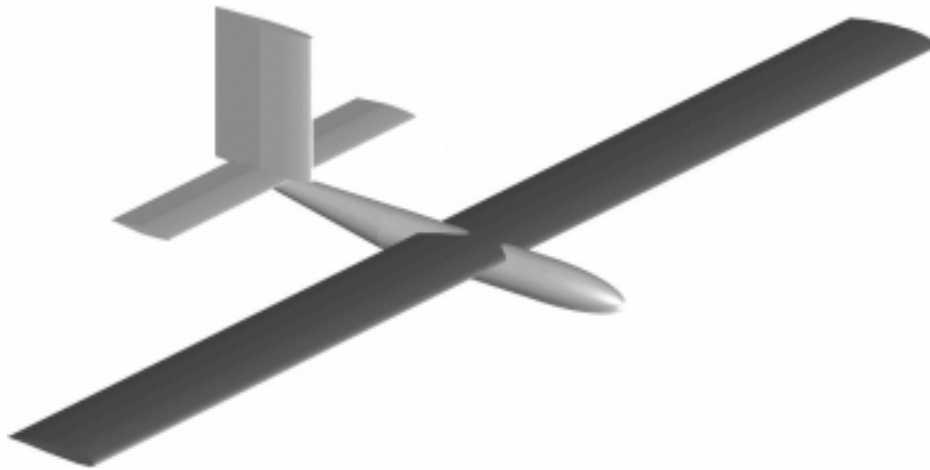

Figure 6: "Large" aircraft schematic

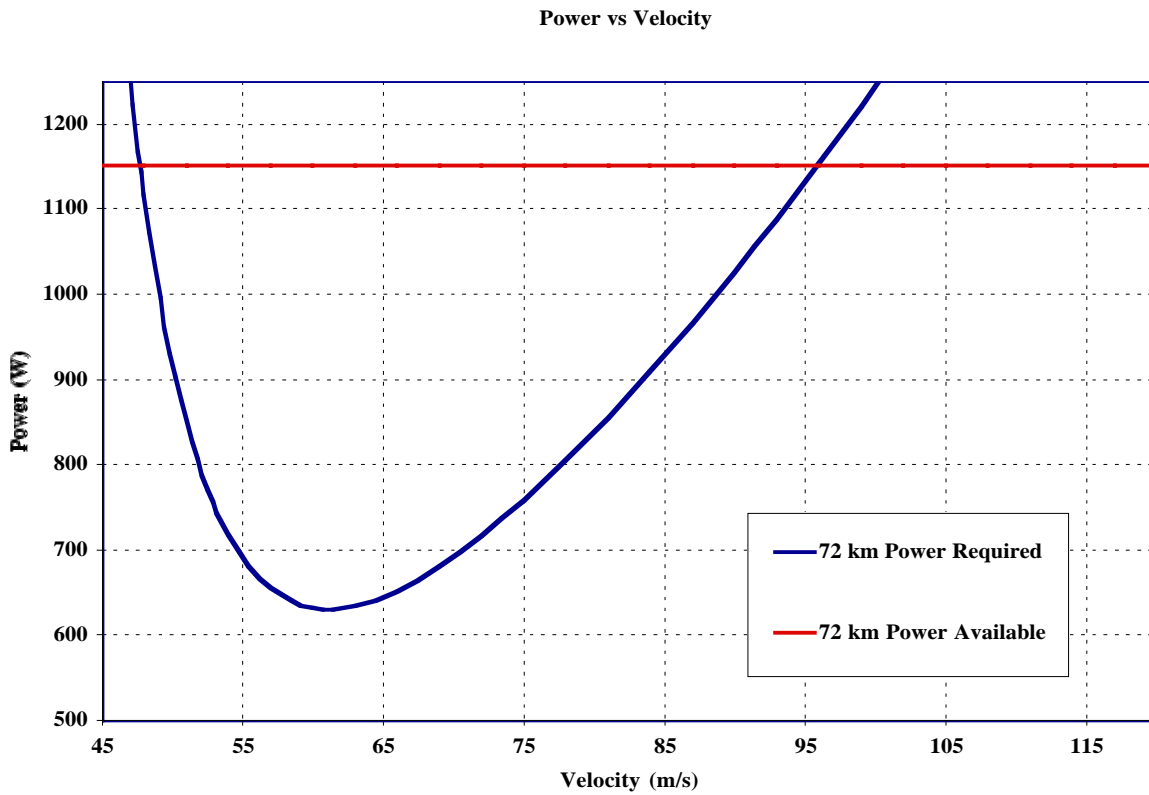

Figure 7: Required power as a function of flight velocity for "large" aircraft design at 72 kilometer altitude, compared with the power available (top curve).

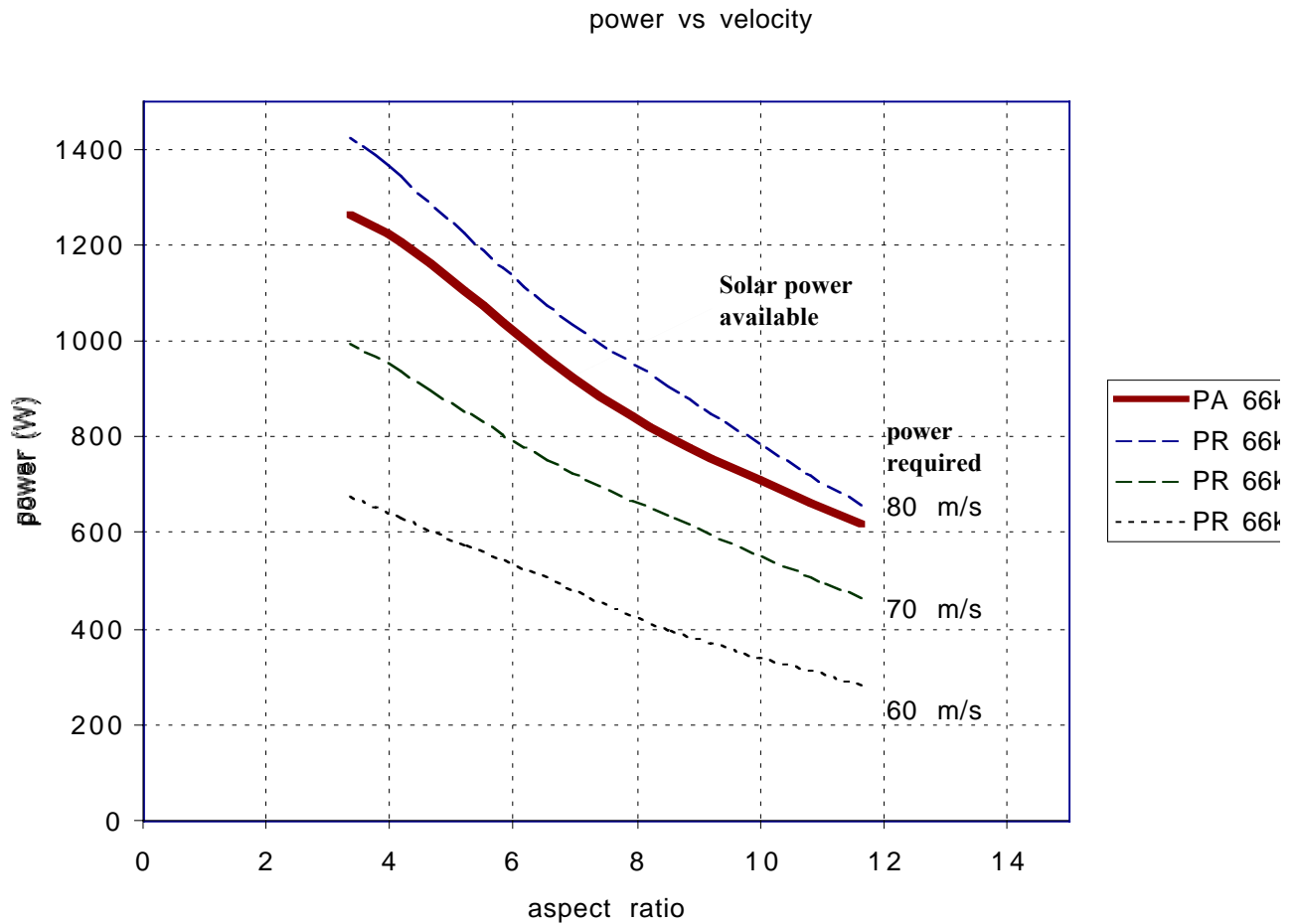

Figure 8: Effect of aspect ratio (small aircraft design, altitude = 66km), comparing the power required for level flight at 60, 70, and 80 km with the solar power available.

FUTURE VISIONS

Once the concept of airplane planetary exploration has been proven on Venus, the concept could be extended to other planets and moons of the solar system. Possibly the next most attractive target for airplane exploration is Titan, the largest moon of Saturn. With an atmospheric pressure of 1.5 bar but gravity only 15% that of Earth, it is an ideal planet for aircraft. As a future vision, we envision a fleet of aircraft across the solar system, exploring every planet and moon with an atmosphere.

Robotic aircraft exploration of Venus could potentially lead to the development of a human mission to explore the clouds of Venus by aircraft.

At the cloud-top level, Venus is the most Earthlike of the planets, and in the carbon dioxide atmosphere of Venus, a "balloon" of oxygen and nitrogen would be buoyant. A platform floating in the atmosphere of Venus would be an excellent location for human operators of telerobotic surface geological explorers, controlled by advanced high-temperature electronics and featuring robust, thermally-tolerant construction.

Ultimately we could even envision colonization of the Venus atmosphere. Space colonies are widely discussed as a way of expanding the presence of humans into the solar system. The atmosphere of Venus is potentially the best place in the solar system to locate space colonies. It is rich in resources, and at a temperature and pressure hospitable to human life.

CONCLUSIONS

While Venus has a hot, high-pressure environment near the surface, at altitudes near the cloud layers and above, the conditions are ideal for powered flight. Solar powered flight on Venus is not only possible, it is possible to explore regions of the atmosphere, including the cloud tops using an extremely small aircraft, while carrying a reasonable payload of scientific instruments. The aircraft analyzed are of a size that is compatible with a low-cost "Discovery" class mission.

Large aircraft are more efficient than small ones. Since flight of an aircraft of 1-2 square meter wing area have been shown to be feasible, design of larger aircraft and more capable is also possible.

An aircraft, with the ability to control its position in the atmosphere of Venus instead of drifting helplessly with the wind, would be a powerful tool for exploration. By learning how Venus can be so similar to Earth, and yet so different, we will learn to better understand the climate and geological history of the Earth. The success of a prototype solar airplane could lead to the development of a fleet of solar-powered airplanes flying across the Venus cloud tops, taking simultaneous measurements to develop a "snapshot" of the climate across the face of the planet. Fleets of solar-powered aircraft could provide an architecture for efficient and low-cost comprehensive coverage for a variety of scientific missions, both atmospheric and geological science via surface imaging and radar. Exploratory planetary mapping and atmospheric sampling can lead to a greater understanding of the greenhouse effect not only on Venus but on Earth as well.

Further work to define a mission model and scientific objectives, and detailed design of the aircraft, is required.

REFERENCES

1. D. M. Hunten, L. Colin, T. M. Donahue, and V. I. Moroz, eds., *Venus*, University of Arizona Press 1983.
2. S. Vougher, D. Hunten, and R. Phillips, eds., *Venus II*, University of Arizona Press, 1997.
3. Geoffrey A. Landis, "Exploring Venus by Solar Airplane," presented at the STAIF Conference on Space Exploration Technology,

Albuquerque NM, Feb. 11-15, 2001. *AIP Conference Proceedings Volume 552*, pp. 16-18, 2001.

4. R. Fimmel, L. Colin, and E Burgess, *Pioneer Venus*, NASA SP-461, 1983.
5. A. Ekonomov, Yu. Golovin, V. Moroz and B. Moshkin, "19: Solar Scattered Radiation Measurements by Venus Probes," in D. M. Hunten, L. Colin, T. M. Donahue, and V. I. Moroz, eds., *Venus*, University of Arizona Press 1983.
6. A. Seiff, "Thermal Structure of the Atmosphere of Venus," in D. M. Hunten, L. Colin, T. M. Donahue, and V. I. Moroz, eds., *Venus*, University of Arizona Press 1983.
7. B. W. McCormick, *Aerodynamics, Aeronautics, and Flight Mechanics*, John Wiley and Sons, New York, 1979.
8. A. J. Colozza, "Preliminary Design of a Long-Endurance Mars Aircraft," *NASA CR 185243*, April 1990.
9. P. B. MacCready, P. Licsaman, W. R. Morgan, and J. D. Burke, "Sun Powered Aircraft Design," *AIAA 81-0916*, May 1981.
10. A. J. Colozza, "Effect of Power System Technology and Mission Requirements on High Altitude Long Endurance Aircraft," *NASA Contractor Report CR-19445*, 1994.
11. G. Landis, S. Bailey and M. Piszczor, "Recent Advances in Solar Cell Technology," *J. Propulsion and Power*, Vol. 12, No. 5, 835-841, Sept-Oct. 1996. Paper AIAA-95-0027.
12. D. Scheiman, G. Landis, D. Brinker, and V. Weizer, "High-Bandgap Solar Cells for Near-Sun Missions," Space Technology and Applications International Forum, *AIP Conference Proceedings Volume 458*, pp. 616-620, 1999
13. W. Stender, "Sailplane Weight Estimation," *Organsiation Scientifique et Technique Internationale du vol a Voile*, 1969.