



U.S. Department  
of Transportation  
**Federal Highway  
Administration**

**Publication No. FHWA NHI-01-031  
May 2002**

**NHI Course No. 132031**

---

# **Subsurface Investigations**

## **— Geotechnical Site Characterization**

Reference Manual



*National Highway Institute*

## NOTICE

The contents of this report reflect the views of the authors, who are responsible for the facts and the accuracy of the data presented herein. The contents do not necessarily reflect policy of the U.S. Department of Transportation. This report does not constitute a standard, specification, or regulation. The United States Government does not endorse products or manufacturers. Trade or manufacturer's names appear herein only because they are considered essential to the object of this document.

1. REPORT NO. FHWA-NHI-01-031		2. GOVERNMENT ACCESSION NO.		3. RECIPIENT'S CATALOG NO.	
4. TITLE AND SUBTITLE Subsurface Investigations (Geotechnical Site Characterization)		5. REPORT DATE May 2002		6. PERFORMING ORGANIZATION CODE	
		8. PERFORMING ORGANIZATION REPORT NO.		7. AUTHOR(S) Paul W. Mayne, Ph.D., P.E., Barry R. Christopher, Ph.D., P.E. and Jason DeJong, Ph.D.	
9. PERFORMING ORGANIZATION NAME AND ADDRESS Ryan R. Berg & Associates, Inc. 2190 Leyland Alcove Woodbury, MN 55125		10. WORK UNIT NO.		11. CONTRACT OR GRANT NO. DTFH61-00-T-25043	
		12. SPONSORING AGENCY NAME AND ADDRESS National Highway Institute Federal Highway Administration U.S. Department of Transportation Washington, D.C.		13. TYPE OF REPORT & PERIOD COVERED	
14. SPONSORING AGENCY CODE		15. SUPPLEMENTARY NOTES FHWA Technical Consultants: J.A. DiMaggio, P.E. and P. Osborn, P.E. COTR - L. Jones <i>This manual is an update and revision of FHWA-HI-97-021 prepared by Parsons Brinckerhoff Quade &amp; Douglas, Inc, in association with Woodward-Clyde Consultants; Principal Investigator: George Munfakh; Authors: Ara Arman, Naresh Samtani, Raymond Castelli and George Munfakh; FHWA Technical Consultants: J.A. DiMaggio, A. Muñoz, A. Kilian, and P. Osborn</i>			
16. ABSTRACT This manual is the reference text used for the FHWA NHI course No. 13231 on <b>Subsurface Investigations</b> and reflects current practice for such. The planning, execution, and interpretation of geotechnical site explorations in natural soil and rock are presented with regard to the design and construction of transportation facilities. The role of the geotechnical engineer in subsurface investigation, exploration methods, equipment types and their suitability are discussed. Various in-situ tests are presented, including cone penetration, dilatometer, pressuremeter, vane, and standard penetration. Rotary drilling and rock coring are reviewed in terms of the proper handling, transportation, and storage of soil and rock samples for laboratory testing. Geophysical wave and electromagnetic methods are covered. Laboratory index, strength, and stiffness testing are reviewed in complement to the field testing program. Geomaterial characterization requires the interpretation and correlation of engineering properties from the acquired field and lab measurements. The results are summarized in a geotechnical report with available geological, topographical, hydrological, and geotechnical data collected towards the analysis and design of earthwork structures and foundation design.					
17. KEY WORDS Subsurface, investigation, geomaterials, subgrade, exploration, drilling, coring, sampling, soil, rock, field testing, in-situ, laboratory testing, geophysics, cone penetrometer, vane, groundwater, geotechnical report, transportation, tunnels, slopes, highways, bridges.			18. DISTRIBUTION STATEMENT No restrictions.		
19. SECURITY CLASSIF. Unclassified	20. SECURITY CLASSIF. Unclassified	21. NO. OF PAGES 300	22. PRICE		

[Blank]

## PREFACE

This module is the first in a series of twelve modules that constitute a comprehensive training course in geotechnical and foundation engineering. Sponsored by the National Highway Institute (NHI) of the Federal Highway Administration (FHWA), the training course is given at different locations in the U.S. The intended audience includes civil engineers and engineering geologists involved in the design and construction of transportation facilities. This manual is designed to present the latest methodologies in the planning, execution and interpretation of the various subsurface investigation methods, and the development of appropriate soil and rock parameters for engineering applications.

The authors have made every effort to present the general state of the practice of subsurface exploration and geotechnical site characterization. It is understood that the procedures discussed in the manual are subject to local variations. It is important, therefore, for the reader to become thoroughly familiar with the local practices as well. This guide focuses on the scope and specific elements of typical geotechnical investigation programs for design and construction of highways and related transportation facilities. Considering the broad scope and fundamental importance of this subject, this manual on subsurface investigations is organized as follows:

- ' Chapters 1 through 6 discuss various aspects of field investigations, including soil borings, augering, rock coring, sampling, in-situ testing, and geophysical exploration methods.
- ' Chapters 7 and 8 discuss laboratory testing of soil and rock materials.
- ' Chapters 9 and 10 present interpretation procedures for soil and rock properties.
- ' Chapters 11 and 12 address issues related to data management and interpretation, including evaluation and synthesis of the field and laboratory test data, development of soil and rock design parameters, and the presentation of investigation findings in geotechnical reports.
- ' Chapter 13 contains a list of cited references for further details & information.
- ' Appendix A contains information on health and safety issues.
- ' Appendix B lists names and websites of soil & rock drilling and in-situ testing equipment manufacturers, distributors, and service companies.

This manual is not intended to be an exclusive reference on subsurface investigations and it is highly recommended that the references given in Chapter 13 be made part of the reader's library and reviewed in detail. Two important references are the *Manual on Subsurface Investigations* by AASHTO (1988) and the FHWA Manual *Evaluation of Soil and Rock Properties* (Geotechnical Engineering Circular No. 5, 2001). Finally, this manual is developed to be used as a living document. After attending the training session, it is intended that the participant will use it as a manual of practice in everyday work. Throughout the manual, attention is given to ensure the compatibility of its content with those of the participants manuals prepared for the other training modules. Special efforts are made to ensure that the included material is practical in nature and represents the latest developments in the field.

## SI CONVERSION FACTORS

### APPROXIMATE CONVERSIONS FROM SI UNITS

Symbol	When You Know	Multiply By	To Find	Symbol
<b>LENGTH</b>				
mm	millimeters	0.039	inches	in
m	meters	3.28	feet	ft
m	meters	1.09	yards	yd
km	kilometers	0.621	miles	mi
<b>AREA</b>				
mm <sup>2</sup>	square millimeters	0.0016	square inches	in <sup>2</sup>
m <sup>2</sup>	square meters	10.764	square feet	ft <sup>2</sup>
ha	hectares	2.47	acres	ac
km <sup>2</sup>	square kilometers	0.386	square miles	mi <sup>2</sup>
<b>VOLUME</b>				
ml	milliliters	0.034	fluid ounces	fl oz
l	liters	0.264	gallons	gal
m <sup>3</sup>	cubic meters	35.71	cubic feet	ft <sup>3</sup>
m <sup>3</sup>	cubic meters	1.307	cubic yards	yd <sup>3</sup>
<b>MASS</b>				
g	grams	0.035	ounces	oz
kg	kilograms	2.205	pounds	lb
<b>TEMPERATURE</b>				
°C	Celsius	1.8 C + 32	Fahrenheit	°F
<b>WEIGHT DENSITY</b>				
g/cc	grams per cubic centimeter	62.4	poundforce /cubic foot	pcf
kN/m <sup>3</sup>	kilonewton /cubic meter	6.36	poundforce /cubic foot	pcf
<b>FORCE and LOAD</b>				
N	newtons	0.225	poundforce	lbf
kN	kilonewtons	225	poundforce	lbf
kg	kilogram (force)	2.205	poundforce	lbf
MN	meganewtons	112.4	tons (force)	t
<b>PRESSURE and STRESS*</b>				
kPa*	kilopascals	0.145	poundforce /square inch	psi
kPa	kilopascals	20.9	poundforce /square foot	psf
MPa	megapascal	10.44	tons per square foot	tsf
kg/cm <sup>2</sup>	kilograms per square cm	1.024	tons per square foot	tsf

\*Notes: 1 kPa = kN/m<sup>2</sup> = one kilopascal = one kilonewton per square meter.

For dimensionless graphs and equations, a reference stress of one atmosphere can be used, such that  $\sigma_a = p_{atm} = 1 \text{ bar} = 100 \text{ kPa} \cdot 1 \text{ tsf} \cdot 1 \text{ kg/cm}^2$ .

# SUBSURFACE INVESTIGATIONS

## TABLE OF CONTENTS

	Page
Preface .....	i
Units Conversions .....	ii
Table of Contents .....	iii
LIST OF TABLES .....	xiii
LIST OF FIGURES .....	xv
LIST OF NOTATIONS .....	xxii
1.0 Introduction .....	1-1
1.1 Scope of this Manual .....	1-1
1.2 Geotechnical Engineer's Role in Subsurface Exploration .....	1-2
2.0 Project Initiation .....	2-1
2.1 Project Type .....	2-1
2.1.1 New Construction .....	2-1
2.1.2 Rehabilitation Projects .....	2-2
2.1.3 Contaminated Sites .....	2-3
2.2 Existing Data Sources .....	2-4
2.3 Site Visit/plan-in-hand .....	2-6
2.4 Communication with Designers/Project Managers .....	2-6
2.5 Subsurface Exploration Planning .....	2-8
2.5.1 Types of Investigation .....	2-8
• Remote Sensing .....	2-8
• Geophysical Investigations .....	2-10
• Disturbed Sampling .....	2-10
• In-Situ Investigation .....	2-10
• Undisturbed Sampling .....	2-10
2.5.2 Frequency and Depth of Borings .....	2-10
2.5.3 Boring Locations and Elevations .....	2-12
2.5.4 Equipment .....	2-12
2.5.5 Personnel and Personal Behavior .....	2-15
2.5.6 Plans and Specifications .....	2-15
2.6 Standards and Guidelines .....	2-15
3.0 Drilling and Sampling of Soil and Rock .....	3-1
3.1 Soil Exploration .....	3-1
3.1.1 Soil Drilling .....	3-1

	• Continuous Flight Augers	3-1
	• Hollow-Stem Augers	3-2
	• Rotary Wash Borings	3-5
	• Bucket Auger Borings	3-8
	• Area Specific Methods	3-9
	• Hand Auger Borings	3-9
	• Exploration Pit Excavation	3-9
	• Logging Procedures	3-10
	• Photography	3-10
3.1.2	Soil Samples	3-10
	• Disturbed Samples	3-10
	• Undisturbed Samples	3-10
3.1.3	Soil Samplers	3-11
	• Split Barrel Sampler	3-11
	• Thin Wall Sampler	3-14
	• Piston Sampler	3-15
	• Pitcher Tube Sampler	3-16
	• Denison Sampler	3-18
	• Modified California Sampler	3-18
	• Continuous Soil Sampler	3-18
	• Other Soil Samplers	3-19
	• Bulk Samples	3-19
	• Block Samples	3-19
3.1.4	Sampling Interval and Appropriate Type of Sampler	3-20
3.1.5	Sample Recovery	3-20
3.1.6	Sample Identification	3-20
3.1.7	Relative Strength Tests	3-21
3.1.8	Care and Preservation of Undisturbed Soil Samples	3-21
3.2	Exploration of Rock	3-22
3.2.1	Rock Drilling and Sampling	3-22
3.2.2	Non-Core (Destructive) Drilling	3-23
3.2.3	Types of Core Drilling	3-23
	• Coring Bits	3-25
	• Drilling Fluid	3-26
3.2.4	Observation During Core Drilling	3-26
	• Drilling Rate/Time	3-26
	• Core Photographs	3-26
	• Rock Classification	3-27
	• Recovery	3-27
	• Rock Quality Designation (RQD)	3-27
	• Length Measurements of Core Pieces	3-27
	• Assessment of Soundness	3-28
	• Drilling Fluid Recovery	3-29
	• Core Handling and Labeling	3-29
	• Care and Preservation of Rock Samples	3-31
3.2.5	Geologic Mapping	3-31
3.3	Boring Closure	3-32
3.4	Safety Guidelines for Geotechnical Borings	3-32
3.5	Common Drilling Errors	3-35



4.0	Boring Log Preparation	4-1
4.1	General	4-1
4.2	Project Information	4-9
4.3	Boring Locations and Elevations	4-9
4.4	Stratigraphy Identification	4-9
4.5	Sample Information	4-10
4.6	Soil Description and Soil Classification	4-10
4.6.1	Soil Description	4-10
	• Consistency and Apparent Density	4-11
	• Water Content (Moisture)	4-11
	• Color	4-12
	• Type of Soil	4-13
	< Coarse-Grained Soils (Gravel and Sand)	4-13
	- Feel and Smear Test	4-13
	- Sedimentation Test	4-14
	- Visual Characteristics	4-14
	< Fine-Grained Soils	4-15
	- Shaking (Dilatancy) Test	4-15
	- Dry Strength Test	4-15
	- Thread Test	4-15
	- Smear Test	4-15
	• Highly Organic Soils	4-15
	• Minor Soil Type(s)	4-17
	• Inclusions	4-17
	• Layered Soils	4-17
	• Geological Name	4-18
4.6.2	Soil Classification System	4-18
	• The Unified Classification System	4-18
	• Classification of Coarse-Grained Soils	4-19
	• Classification of Fine-Grained Soils	4-23
4.6.3	AASHTO Soil Classification System	4-26
4.7	Logging Procedures for Core Drilling	4-28
4.7.1	Description of Rock	4-28
4.7.2	Rock Type	4-29
4.7.3	Color	4-29
4.7.4	Grain Size and Shape	4-29
4.7.5	Stratification/Foliation	4-29
4.7.6	Mineral Composition	4-32
4.7.7	Weathering and Alteration	4-32
4.7.8	Strength	4-32
4.7.9	Hardness	4-32
4.7.10	Rock Discontinuity	4-33
4.7.11	Fracture Description	4-34
5.0	In-Situ Testing	5-1
5.1	Standard Penetration Test (SPT)	5-2
5.2	Cone Penetration Testing (CPT)	5-5
	• Piezocone Penetration Testing (CPTu)	5-6
	• Baseline Readings	5-8

	• Routine CPTu Operations	5-8
	• CPT Profiles	5-9
5.3	Vane Shear Test (VST)	5-10
	• Undrained Strength and Sensitivity	5-11
	• Field Vane Results	5-13
	• Vane Correction Factor	5-14
5.4	Flat Plate Dilatometer Testing (DMT)	5-16
5.5	Pressuremeter Testing (PMT)	5-19
5.6	Special Probes and In-Situ Tests	5-22
5.7	Geophysical Methods	5-23
	5.7.1 Mechanical Waves	5-23
	5.7.2 Seismic Refraction (SR)	5-25
	5.7.3 Crosshole Tests (CHT)	5-26
	5.7.4 Downhole Tests (DHT)	5-27
	5.7.5 Surface Waves (SASW)	5-30
	5.7.6 Electromagnetic Waves	5-32
	• Ground Penetrating Radar	5-32
	• Electrical Resistivity (ER) Survey	5-34
	• Electromagnetic (EM) Techniques	5-35
	• Magnetic Surveys	5-36
5.8	Summary on In-Situ and Geophysical Methods	5-36
6.0	Groundwater Investigations	6-1
6.1	General	6-1
6.2	Determination of Groundwater Levels and Pressures	6-1
	6.2.1 Information on Existing Wells	6-1
	6.2.2 Open Borings	6-2
	6.2.3 Observation Wells	6-2
	6.2.4 Water Level Measurements	6-3
	• Chalked Tape	6-4
	• Tape with a Float	6-4
	• Electric Water-Level Indicator	6-4
	• Data Loggers	6-4
6.3	Field Measurement of Permeability	6-5
	6.3.1 Seepage Tests	6-6
	• Falling Water Level Method	6-7
	• Rising Water Level Method	6-7
	• Constant Water Level Method	6-7
	6.3.2 Pressure (“Packer”) Test	6-8
	6.3.3 Pumping Tests	6-10
	6.3.4 Slug Tests	6-15
	6.3.5 Piezocone Dissipation Tests	6-16
7.0	Laboratory Testing for Soils	7-1
7.1	General	7-1
	7.1.1 Weight-Volume Concepts	7-1
	7.1.2 Load-Deformation Process in Soils	7-2
	7.1.3 Principle of Effective Stress	7-3
	7.1.4 Overburden Stress	7-3

7.1.5	Selection & Assignment of Tests	7-4
7.1.6	Visual Identification of Soils	7-7
7.1.7	Index Properties	7-8
	• Moisture Content	7-8
	• Specific Gravity	7-8
	• Unit Weight	7-9
	• Sieve Analysis	7-10
	• Hydrometer Analysis	7-11
	• Atterberg Limits	7-11
	• Moisture-Density (Compaction) Relationship	7-13
	• Classification of Soils	7-14
	• Corrosivity of Soils	7-14
	• Resistivity	7-15
	• Organic Content of Soils	7-15
7.1.8	Strength Tests	7-16
	Total or Effective Stress Analysis	7-16
	• Unconfined Compressive Strength of Soils	7-18
	• Triaxial Strength (TX)	7-19
	• Direct Shear (DS)	7-22
	• Direct Simple Shear (DSS) Test	7-22
	• Resonant Column	7-24
	• Miniature Vane	7-26
	• California Bearing Ratio (CBR)	7-26
	• R-Value Test	7-27
	• Resilient Modulus	7-27
7.1.9	Permeability	7-28
7.1.10	Consolidation	7-30
	• One-Dimensional Compression (Consolidation)	7-30
	• Swell Potential of Clays	7-33
	• Collapse Potential of Soils	7-33
7.2	Quality Assurance for Laboratory Testing	7-34
7.2.1	Storage	7-34
7.2.2	Sample Handling	7-34
7.2.3	Specimen Selection	7-34
7.2.4	Equipment Calibration	7-35
7.2.5	Pitfalls	7-35
7.3	Selection and Assignment of Tests	7-37
8.0	Laboratory Testing for Rocks	8-1
8.1	Introduction	8-1
8.2	Laboratory Tests	8-1
8.2.1	Strength Tests	8-1
	• Point-Load Strength Test	8-3
	• Uniaxial Compression Test	8-4
	• Split Tension (Brazilian) Test	8-5
	• Direct Shear Strength of Rock	8-6
8.2.2	Durability	8-7
	• Slake Durability	8-8
	• Soundness of Riprap	8-9

	• Durability Under Freezing and Thawing . . . . .	8-9
8.2.3	Strength-Deformation Characteristics . . . . .	8-10
	• Elastic Moduli . . . . .	8-10
	• Ultrasonic Testing . . . . .	8-11
8.3	Quality Assurance for Laboratory Testing . . . . .	8-12
8.3.1	Cautions . . . . .	8-12
9.0	Interpretation of Soil Properties . . . . .	9-1
9.1	Introduction . . . . .	9-1
9.2	Compositional and Classification . . . . .	9-2
9.2.1	Soil Classification and Geostatigraphy . . . . .	9-2
9.2.2	Soil Classification by Soil Sampling & Drilling . . . . .	9-2
9.2.3	Soil Classification by Cone Penetration Testing . . . . .	9-4
9.2.4	Soil Classification by Flat Dilatometer . . . . .	9-6
9.3	Density . . . . .	9-6
9.3.1	Unit Weight . . . . .	9-6
9.3.2	Relative Density Correlations for Sands . . . . .	9-8
9.4	Strength and Stress History . . . . .	9-13
9.4.1	Drained Friction Angles of Sands . . . . .	9-13
9.4.2	Preconsolidation Stress of Clays . . . . .	9-17
9.4.3	Undrained Strength of Clays and Silts . . . . .	9-22
9.4.4	Lateral Stress State . . . . .	9-25
9.5	Stiffness and Deformation Parameters . . . . .	9-27
9.5.1	Small-Strain Shear Modulus . . . . .	9-29
9.5.2	Modulus Reduction . . . . .	9-30
9.5.3	Direct and Indirect Assessments of $G_0$ . . . . .	9-32
9.6	Flow Properties . . . . .	9-36
9.6.1	Monotonic Dissipations . . . . .	9-36
9.6.2	Dilatatory Dissipations . . . . .	9-40
9.7	Nontextbook Materials . . . . .	9-42
10.0	Interpretation of Rock Properties . . . . .	10-1
10.1	Introduction . . . . .	10-1
10.2	Intact Rock Properties . . . . .	10-5
10.2.1	Specific Gravity . . . . .	10-5
10.2.2	Unit Weight . . . . .	10-5
10.2.3	Ultrasonic Velocities . . . . .	10-6
10.2.4	Compressive Strength . . . . .	10-8
10.2.5	Direct and Indirect Tensile Strength . . . . .	10-9
10.2.6	Elastic Modulus of Intact Rock . . . . .	10-11
10.3	Operational Shear Strength . . . . .	10-15
10.4	Rock Mass Classifications . . . . .	10-18
10.4.1	Rock Mass Rating System (RMR) . . . . .	10-20
10.4.2	NGI Q-Rating . . . . .	10-20
10.4.3	Geological Strength Index (GSI) System . . . . .	10-22
10.5	Rock Mass Strength . . . . .	10-24
10.6	Rock Mass Modulus . . . . .	10-26
10.7	Foundation Resistances . . . . .	10-27

	10.7.1	Allowable Bearing Stress for Foundations .....	10-27
	10.7.2	Side Resistances for Drilled Shafts .....	10-29
10.8		Additional Rock Mass Parameters .....	10-30
11.0		Geotechnical Reports .....	11-1
	11.1	Types of Reports .....	11-1
		11.1.1 Geotechnical Investigation Reports .....	11-1
		11.1.2 Geotechnical Design Reports .....	11-2
		11.1.3 GeoEnvironmental Reports .....	11-5
	11.2	Data Presentation .....	11-5
		11.2.1 Borings Logs .....	11-5
		11.2.2 Test Location Plans .....	11-6
		11.2.3 Subsurface Profiles .....	11-8
	11.3	Limitations .....	11-9
12.0		Contracting of Geotechnical Subsurface Exploration .....	12-1
	12.1	Drilling and Testing Specifications .....	12-1
13.0		References .....	13-1
Appendix A		Safety Guidelines for Drilling into Soil and Rock and Health and Safety Procedures for Entry into Borings .....	A-1
Appendix B		Websites: Geotechnical Equipment Suppliers and Service Testing Companies .....	B-1

[Blank]

## LIST OF TABLES

Table 2-1.	General Guidelines for Geotechnical Field Inspectors .....	2-9
Table 2-2.	Minimum Requirements for Boring Depths .....	2-11
Table 2-3.	Guidelines for Boring Layout .....	2-13
Table 2-4.	List of Equipment for Field Explorations .....	2-14
Table 2-5.	Frequently-used Standards for Field Investigations .....	2-16
Table 3-1.	Dimensions of Common Hollow-stem Augers .....	3-3
Table 3-2.	Dimensions of Common Drill Rods .....	3-6
Table 3-3.	Dimensions of Common Flush-joint Casings .....	3-6
Table 3-4.	Common Sampling Methods .....	3-11
Table 4-1.	Evaluation of the Apparent Density of Coarse-grained Soils .....	4-12
Table 4-2.	Evaluation of the Consistency of Fine-grained Soils .....	4-12
Table 4-3.	Adjectives to Describe Water Content of Soils .....	4-13
Table 4-4.	Particle Size Definition for Gravels and Sands .....	4-14
Table 4-5.	Adjectives for Describing Size Distribution for Sands and Gravels .....	4-15
Table 4-6.	Field Methods to Describe Plasticity .....	4-16
Table 4-7.	Descriptive Terms for Layered Soils .....	4-18
Table 4-8.	The Unified Classification System .....	4-19
Table 4-9.	Soil Classification Chart (Laboratory Method) .....	4-20
Table 4-10.	Soil Plasticity Descriptions .....	4-24
Table 4-11.	Examples of Description of Fine-grained Soils .....	4-24
Table 4-12.	AASHTO Soil Classification System .....	4-27
Table 4-13.	Rock Groups and Types .....	4-30
Table 4-14.	Terms to Describe Grain Size of (Typically For) Sedimentary Rocks .....	4-31
Table 4-15.	Terms to Describe Grain Shape (For Sedimentary Rocks) .....	4-31
Table 4-16.	Terms to Describe Stratum Thickness .....	4-31
Table 4-17.	Terms to Describe Rock Hardness .....	4-32
Table 4-18.	Terms to Classify Discontinuities Based on Aperture Size .....	4-33
Table 5-1.	Relevance of In-situ Tests to Different Soil Types .....	5-37
Table 6-1.	Field Methods for Measurement of Permeability .....	6-6
Table 6-2.	Time Intervals for Reading During Pumping Test .....	6-12
Table 7-1.	Terms in Weight-volume Relations .....	7-1
Table 7-2.	Unit Weight-volume Relationships .....	7-2
Table 7-3.	AASHTO And ASTM Standards for Frequently-Used Laboratory Testing of Soils .....	7-5
Table 7-4.	Common Sense Guidelines for Laboratory Testing of Soils .....	7-36
Table 7-5.	Summary of Information Needs and Testing Considerations for a Range of Highway Applications .....	7-38

Table 8-1.	Standards & Procedures for Laboratory Testing of Intact Rock .....	8-2
Table 8-2.	Common Sense Guidelines for Laboratory Testing of Rocks .....	8-12
Table 9-1.	Representative Permeability Values for Soils .....	9-37
Table 10-1.	Primary Rock Types Classified by Geologic Origin .....	10-2
Table 10-2.	Geologic Time Scale .....	10-3
Table 10-3.	Representative Range of Dry Unit Weights .....	10-6
Table 10-4.	Representative Measured Parameters on Intact Rock Specimens .....	10-8
Table 10-5.	Engineering Classification of Intact Rock .....	10-11
Table 10-6.	Friction Angles for Rock Joints, Minerals, & Fillings .....	10-17
Table 10-7.	Residual Friction Angles .....	10-18
Table 10-8.	Empirical Methods for Evaluating Elastic Modulus ( $E_M$ ) of Rock Masses .....	10-27



## LIST OF FIGURES

Figure 1-1.	Natural Geomaterials: (a) Atlantic Dune Sand Deposits; (b) Sandstone in Moab, UT . . . . .	1-1
Figure 2-1.	New Highway Construction: (a) Pile Bent Bridge in NC and (b) Cut Slope in VA. . . . .	2-1
Figure 2-2.	Rehabilitation Projects Including: (a) Highway Slope Failure Involving Loss of Life; (b) Roadway Landslide; (c) Sinkhole in Orlando, Florida; and (d) Slope Stabilization . . . . .	2-2
Figure 2-3.	Example Field Instructions Form for Geotechnical Investigations . . . . .	2-7
Figure 3-1.	Solid Stem Continuous Flight Auger Drilling System: (a) In use on drill rig, (b) Finger and fishtail bits, (c) Sizes of solid stem auger flights, (d) Different assemblies of bits and auger flights . . . . .	3-2
Figure 3-2.	Hollow Stem Auger Components . . . . .	3-3
Figure 3-3.	Hollow Stem Continuous Flight Auger Drilling Systems: (a) Comparison with solid stem auger; (b) Typical drilling configuration; (c) Sizes of hollow stem auger flights; (d) Stepwise center bit; (e) Outer bits; (f) Outer and inner assembly . . . . .	3-4
Figure 3-4.	Schematic of Drilling Rig for Rotary Wash Methods. . . . .	3-5
Figure 3-5.	Rotary Wash Drilling System: (a) Typical drilling configuration; (b) Casing and driving shoe; (c) Diamond, drag, and roller bits; (d) Drill fluid discharge; (e) Fluid cuttings catch screen; (f) Settling basin . . . . .	3-7
Figure 3-6.	Setup of Bucket Auger & Rig . . . . .	3-8
Figure 3-7.	Split-Barrel Samplers: (a) Lengths of 457 mm (18 in) and 610 mm (24 in); (b) Inside diameters from 38.1 mm (1.5 in) to 89 mm (3.5 in) . . . . .	3-12
Figure 3-8.	Split Barrel Sampler: (a) Open sampler with soil sample and cutting shoe; (b) Sample jar, split-spoon, Shelby tube, and storage box for transport of jar samples . . . . .	3-13
Figure 3-9.	Split Barrel Sampler. (a) Stainless steel and brass retainer rings (b) Sample catchers . . . . .	3-13
Figure 3-10.	Schematic of Thin-Walled Shelby Tube . . . . .	3-14
Figure 3-11.	Selected Sizes and Types of Thin-Walled Shelby Tubes . . . . .	3-14
Figure 3-12.	Shelby Tube Sealing Methods. (a) Microcrystalline wax (b) O-ring packer . . . . .	3-15
Figure 3-13.	Piston Sampler: (a) Picture with thin-walled tube cut-out to show piston; (b) Schematic . . . . .	3-16
Figure 3-14.	Pitcher Tube Sampler . . . . .	3-16
Figure 3-15.	Pitcher Sampler. (a) Sampler Being Lowered into Drill Hole; (b) Sampler During Sampling of Soft Soils; (c) Sampler During Sampling of Stiff or Dense Soils . . . . .	3-17
Figure 3-16.	Denison Double-Tube Core Barrel Soil Sampler . . . . .	3-18
Figure 3-17.	(a) Single Tube Core Barrel; (b) Rigid Type Double Tube Core Barrel; (c) Swivel Type Double Tube Core Barrel, Series “M” with Ball Bearings . . . . .	3-24

Figure 3-18.	Double Tube Core Barrel. (a) Outer barrel assembly (b) Inner barrel assembly .....	3-25
Figure 3-19.	Coring Bits. From left to right: Diamond, Carbide, & Sawtooth .....	3-25
Figure 3-20.	Modified Core Recovery as an Index of Rock Mass Quality .....	3-28
Figure 3-21.	Length Measurement of Core RQD Determination .....	3-29
Figure 3-22.	Core Box for Storage of Recovered Rock and Labeling .....	3-30
Figure 3-23.	Rock Formations Showing Joints, Cut Slopes, Planes, and Stabilization Measures .....	3-31
Figure 3-24.	(a) Structural Mapping Coding Form for Discontinuity Survey Data .....	3-33
Figure 3-24.	(b) Structural Mapping Coding Form for Slope Assessment .....	3-24
Figure 3-25.	Views of Rotary Drill Rigs Mounted on Trucks for Soil & Rock Exploration	3-36
Figure 4-1.	Representative Boring Log Form .....	4-2
Figure 4-2.	Representative Core Boring Log .....	4-3
Figure 4-3.	Representative Exploration Pit Log .....	4-4
Figure 4-4.	Proposed Key to Boring Log .....	4-5
Figure 4-5.	Proposed Key to Core Boring Log .....	4-7
Figure 4-6.	Flow Chart to Determine the Group Symbol and Group Name for Coarse- grained Soils .....	4-22
Figure 4-7.	Plasticity Chart for Unified Soil Classification System .....	4-23
Figure 4-8a.	Flow Chart to Determine the Group Symbol and Group Name for Fine- Grained Soils .....	4-25
Figure 4-8b.	Flow Chart to Determine the Group Symbol and Group Name for Organic Soils .....	4-25
Figure 4-9.	Range of Liquid Limit and Plasticity Indices for Soils in Soil Classification Groups A-2, A-4, A-5, A-6 and A-7 .....	4-28
Figure 5-1.	Common In-Situ Tests for Geotechnical Site Characterization of Soils .....	5-1
Figure 5-2.	Direct-Push Technology: (a) Truck-Mounted and (b) Track-Mounted Cone Rigs .....	5-2
Figure 5-3.	Sequence of Driving Split-Barrel Sampler During the Standard Penetration Test .....	5-3
Figure 5-4.	SPT-N values from (a) Uncorrected Data and (b) Corrected to 60% Efficiency .....	5-4
Figure 5-5.	Various Cone Penetrometers Including Electric Friction and Piezocone Types	5-6
Figure 5-6.	Geometry and Measurements Taken by Cone and Piezocone Penetrometers ..	5-7
Figure 5-7.	Correction Detail for Porewater Pressures Acting on Cone Tip Resistance ...	5-7
Figure 5-8.	Procedures and Components of the Cone Penetration Test .....	5-8
Figure 5-9.	Piezocone Results next to Mississippi River, Memphis, TN. ....	5-9
Figure 5-10.	General Test Procedure for the Field Vane in Fine-Grained Soils .....	5-11
Figure 5-11.	Selection of Vane Shear Blades, Pushing Frames, and Torquemeter Devices	5-12
Figure 5-12.	Definitions of Vane Geometries for Tapered & Rectangular Blades .....	5-13
Figure 5-13.	Illustrative Results from VSTs Conducted in San Francisco Bay Mud showing Profiles of (a) Peak and Remolded Vane Strengths, and (b) derived Clay Sensitivity .....	5-14

Figure 5-14.	Vane Correction Factor ( $C_v$ ) Expressed in Terms of Plasticity Index and Time to Failure . . . . .	5-15
Figure 5-15.	Setup and Sequence of Procedures for the Flat Plate Dilatometer Test . . . . .	5-17
Figure 5-16.	Flat Plate Dilatometer Equipment: (a) Modern Dual-Element Gauge System; (b) Early Single-Gauge Readout; (c) Computerized Data Acquisition Model	5-18
Figure 5-17.	Example DMT Sounding in Piedmont residual soils (CL to ML) in Charlotte, NC. . . . .	5-18
Figure 5-18.	Test Procedure and Conduct of the Pre-Bored Type (Menard) Pressuremeter Test . . . . .	5-20
Figure 5-19.	Photos of Pressuremeter Equipment, including Menard-type pressure panel, SBP probe, SBP cutter teeth, hydraulic jack, and monocell-type probe . . . . .	5-21
Figure 5-20.	Menard-type Pressuremeter Results for Utah DOT Project . . . . .	5-22
Figure 5-21.	Representative Compression Wave Velocities of Various Soil and Rock Materials . . . . .	5-24
Figure 5-22.	Representative Shear Wave Velocities of Various Soil and Rock Materials . . . . .	5-24
Figure 5-23.	Field Setup & Procedures for Seismic Refraction Method . . . . .	5-25
Figure 5-24.	Data Reduction of SR Measurements to Determine Depth to Hard Layer . . . . .	5-26
Figure 5-25.	Setup and Data Reduction Procedures for Crosshole Seismic Test . . . . .	5-27
Figure 5-26.	Setup and Data Reduction Procedures for Conducting a Downhole Seismic Survey . . . . .	5-28
Figure 5-27.	Summary Shear Wave Trains from Downhole Tests at Mud Island, Memphis, TN. . . . .	5-28
Figure 5-28.	Results of Seismic Piezocone Sounding in Residual Soils in Coweta County, Georgia showing four independent readings with depth. . . . .	5-29
Figure 5-29.	Field Setup for Conducting Spectral Analysis of Surface Waves (SASW) . . . . .	5-30
Figure 5-30.	Spectrum Analyzer and Data Logging Equipment for SASW . . . . .	5-30
Figure 5-31.	Comparison of Shear Wave Profiles from Different Geophysical Techniques . . . . .	5-31
Figure 5-32.	Ground Penetrating Radar (GPR) Equipment from Xadar, GeoVision, and EKKO Sensors & Software . . . . .	5-32
Figure 5-33.	GPR Results: (a) Buried Utility Locations; (b) Soil Profile of Fill over Soil; and (c) GPR Locating of Underground Tanks and Pipes . . . . .	5-33
Figure 5-34.	Representative Values of Resistivity for Different Geomaterials . . . . .	5-34
Figure 5-35.	Electrical Resistivity Equipment and Results: (a) Oyo System; (b) Advanced Geosciences Inc.; (c) Two-Dimensional Cross-Section Resistivity Profile for Detection of Sinkholes and Caves in Limestone . . . . .	5-35
Figure 5-36.	EM Survey to Detect Underground Storage Tanks	5-35
Figure 5-37.	Magnetometer Survey Results . . . . .	5-36
Figure 6-1:	Representative Details of Observation Well Installations. (a) Drilled-in-place Stand-Pipe Piezometer, (b) Driven Well Point . . . . .	6-3
Figure 6-2:	Packer-Type Pressure-Test Apparatus for Determining the Permeability of Rock. (a) Schematic Diagram; (b) Detail of Packer Unit . . . . .	6-8
Figure 6-3.	A General Configuration and Layout of Piezometers for a Pumping Test . . . . .	6-11
Figure 6-4.	Drawdown in an Observation Well Versus Pumping Time . . . . .	6-13

Figure 6-5.	Definitions of Terms in Pumping Test Within an Unconfined Aquifer . . . . .	6-14
Figure 6-6.	Definitions of Terms in Pumping Test Within a Confined Aquifer System . .	6-14
Figure 6-7.	General Procedure for Slug Test in as Screened Borehole . . . . .	6-15
Figure 6-8.	Porewater Pressure Dissipation Response in Soft Varved Clay at Amherst NGES . . . . .	6-17
Figure 6-9.	Coefficient of Permeability ( $k$ = Hydraulic Conductivity) from Measured Time to 50% Consolidation ( $t_{50}$ ) for Monotonic Type 2 Piezocone Dissipation Tests . . . . .	6-18
Figure 7-1.	Laboratory Sieves for Mechanical Analysis for Grain Size Distributions . . . . .	7-9
Figure 7-2.	Representative Grain Size Curves for Several Soil Types . . . . .	7-10
Figure 7-3.	Liquid Limit Test by (a) Manual Casagrande Cup Device; (b) Electric Fall Cone . . . . .	7-12
Figure 7-4.	A Representative Moisture-Density Relationship from a Standard Compaction Test . . . . .	7-12
Figure 7-5.	Definitions of Effective Stress Parameters For Mohr-Coulomb Failure Criterion . . . . .	7-17
Figure 7-6.	Measured Stress-Strain for Unconfined Compressive Test . . . . .	7-18
Figure 7-7.	Triaxial Test Apparatuses and Equipment . . . . .	7-20
Figure 7-8.	Effective Stress Mohr Circles for Consolidated Undrained Triaxial Tests . . .	7-21
Figure 7-9.	Effective $q$ - $p'$ Strength Envelopes for Consolidated Undrained Triaxial Tests . . . . .	7-21
Figure 7-10.	Direct Shear Test Devices . . . . .	7-23
Figure 7-11.	Illustrative Results from DS Tests on Clay Involved in Route 1 Slope Stability Study, Raleigh, NC . . . . .	7-23
Figure 7-12.	Resonant Column Test (RCT) Equipment for Determining $G_{max}$ and $D$ in Soils . . . . .	7-24
Figure 7-13.	Results from Resonant Column Testing of Light Castle Sand . . . . .	7-25
Figure 7-14.	Permeability Test Schematics: (a) Constant Head Device; (b) Falling Head Test . . . . .	7-29
Figure 7-15.	Permeameter Equipment: (a) Flexible-Walled Permeameter Cell; (b) Permeability Station with Automatic Volume Change Device (left) and Backpressure Panel Board . . . . .	7-30
Figure 7-16.	One Dimensional Consolidation Devices and Results . . . . .	7-32
Figure 8-0.	(a) Intact Rock Specimens for Laboratory Testing; (b) Compressive Strength Testing . . . . .	8-1
Figure 9-1.	Delineation of Geostatigraphy and Soil & Rock Types by Drill & Sampling Methods . . . . .	9-3
Figure 9-2.	Factors Affecting Cone Penetrometer Test Measurements in Soils . . . . .	9-4
Figure 9-3.	Chart for Soil Behavioral Classification by CPT . . . . .	9-5
Figure 9-4.	Interrelationship Between Saturated Unit Weight and In-Place Water Content of Geomaterials . . . . .	9-7

Figure 9-5.	Unit Weight Relationship with Shear Wave Velocity and Depth in Saturated Geomaterials .....	9-8
Figure 9-6.	Interrelationship Between Minimum and Maximum Dry Densities of Quartz Sands .....	9-9
Figure 9-7.	Maximum Dry Density Relationship with Sand Uniformity Coefficient .....	9-10
Figure 9-8.	Relative Density of Clean Sands from Standard Penetration Test Data .....	9-11
Figure 9-9.	Relative Density Evaluations of NC and OC Clean Quartz Sands from CPT Data .....	9-12
Figure 9-10.	Relative Density of Clean Sands Versus DMT Horizontal Stress Index .....	9-12
Figure 9-11.	Typical Values of $N_f$ and Unit Weight for Cohesionless Soils .....	9-13
Figure 9-12.	Peak Friction Angle of Sands from SPT Resistance .....	9-14
Figure 9-13.	Peak Friction Angle of Unaged Clean Quartz Sands from Normalized CPT Tip Resistance .....	9-15
Figure 9-14.	Evaluation of Peak Friction Angle of Sands from DMT Results Based on Wedge-Plasticity Solutions and Experimental Data .....	9-15
Figure 9-15.	Processing of PMT Data in Sands for Peak $N_f$ Determination .....	9-16
Figure 9-16.	Relation Between Peak $N_f$ for Clean Sands and Slope Parameter ( $s$ ) from PMT Data .....	9-16
Figure 9-17.	Representative Consolidation Test Results in Overconsolidated Clay .....	9-17
Figure 9-18.	Trends for Compression and Swelling Indices in Terms of Plasticity Index ..	9-18
Figure 9-19.	Ratio of Measured Vane Strength to Preconsolidation Stress ( $s_{uv}/F_{pr}$ ) vs. Plasticity Index ( $I_p$ ) .....	9-18
Figure 9-20.	Preconsolidation Stress Relationship with Net Cone Tip Resistance from Electrical CPT .....	9-19
Figure 9-21.	Relationship Between Preconsolidation Stress and Excess Porewater Pressures from Piezocones .....	9-19
Figure 9-22.	Relationship Between Preconsolidation Stress and DMT Effective Contact Pressure in Clays .....	9-20
Figure 9-23.	Relationship Between Preconsolidation Stress and Shear Wave Velocity in Clays .....	9-20
Figure 9-24.	Relationships Between Overconsolidation Ratio and DMT Horizontal Stress Index, $K_D$ from (a) Cavity Expansion-Critical State Theory, and (b) Worldwide Database from Clays .....	9-21
Figure 9-25.	Summary Calibrations of OCR Evaluations Using Piezocone Results in Clays with Superimposed Curves from Analytical Model .....	9-22
Figure 9-26.	Modes of Undrained Shear Strength Ratio for Normally-Consolidated Clays	9-23
Figure 9-27.	Normalized Undrained Strengths for NC Clay Under Different Loading Modes by Constitutive Model .....	9-23
Figure 9-28.	Undrained Strength Ratio Relationship with OCR and $N_f$ for Simple Shear Mode .....	9-24
Figure 9-29.	Field $K_0$ - OCR Relationships for (a) Natural Clays and (b) Natural Sands ..	9-25
Figure 9-30.	Relationship for Lateral Stress State Determination in Sands from CPT .....	9-26
Figure 9-31.	Definitions of Elastic Moduli in Terms of Loading & Applied Boundary Conditions .....	9-27

Figure 9-32.	Idealized Stress-Strain Curve and Stiffnesses of Soils at Small- and Large-Strains	9-28
Figure 9-33.	Conceptual Variation of Shear Modulus with Strain Level Under Static Monotonic Loading and Relevance to In-Situ Tests	9-29
Figure 9-34.	Modulus Reduction with Log Shear Strain for Initial Monotonic (Static) and Dynamic (Cyclic) Loading Conditions	9-30
Figure 9-35.	Modulus Degradation from Instrumented Laboratory Tests on Uncemented and Unstructured Geomaterials	9-31
Figure 9-36.	Modified Hyperbolas to Illustrate Modulus Degradation Curves	9-32
Figure 9-37.	Results of Seismic Piezocone Tests (SCPTu) in Layered Soil Profile, Wolf River, Memphis, TN	9-33
Figure 9-38.	Ratio of $G_0/q_c$ with Normalized CPT Resistance for Uncemented Sands	9-35
Figure 9-39.	Ratio of $G_0/E_D$ with Normalized DMT Reading for Clean Quartz Sands	9-34
Figure 9-40.	Trend Between $G_0$ and CPT Tip Stress $q_T$ in Clay Soils	9-34
Figure 9-41.	Trend Between $G_0$ and DMT modulus $E_D$ in Clay Soils	9-35
Figure 9-42.	Modulus ( $D'$ ) vs. Shear Modulus ( $G_0$ ) in Clays	9-35
Figure 9-43a.	Modified Time Factors for $u_1$ Monotonic Porewater Dissipations	9-38
Figure 9-43b.	Modified Time Factors for $u_2$ Monotonic Porewater Dissipations	9-38
Figure 9-44.	Estimation of Rigidity Index from OCR and Plasticity Index	9-39
Figure 9-45.	Coefficient of Consolidation for 50% Dissipation from Shoulder Readings	9-40
Figure 9-46.	Representative Solutions for Type 2 Dilatory Dissipation Curves at Various OCRs	9-41
Figure 10-1.	Generalized Distribution of Sedimentary, Igneous, & Metamorphic Rocks in the U.S.A	10-1
Figure 10-2.	Factors & Parameters Affecting Geologic Mapping of Rock Mass Features	10-4
Figure 10-3.	Specific Gravity of Solids for Selected Rock Minerals	10-5
Figure 10-4.	Saturated Rock Unit Weight in Terms of Porosity and Specific Gravity	10-7
Figure 10-5.	Representative S- and P-wave velocities for Intact Rock Materials	10-7
Figure 10-6.	Classifications for Unweathered Intact Rock Material Strength	10-9
Figure 10-7.	Interrelationship Between Uniaxial Compression, Triaxial, and Tensile Strength of Intact Rock in Mohr-Coulomb Diagram	10-10
Figure 10-8.	Comparison of Tensile vs. Compressive Strengths for Intact Rock Specimens	10-10
Figure 10-9a.	Elastic Modulus-Compressive Strength Groupings for Intact Igneous Rock Materials	10-12
Figure 10-9b.	Elastic Modulus-Compressive Strength Groupings for Intact Sedimentary Rock Materials	10-13
Figure 10-9c.	Elastic Modulus-Compressive Strength Groupings for Intact Metamorphic Rock Materials	10-14
Figure 10-10.	Small-Strain Elastic Modulus ( $E_{max}$ ) versus Compressive Strength ( $q_u$ ) for All Types of Civil Engineering Materials	10-15
Figure 10-11.	Illustrative Cases for Defining Rock Shear Strength for Cut, including: (a) intact rock strength, (b) intact strength across joints, (c) shear strength along joint planes, and (d) jointed rock mass	10-16
Figure 10-12.	Selection of Exposed Rock Masses from Different Geologic Origins	10-19

Figure 10-13.	The Geomechanics Classification System for Rock Mass Rating (RMR) . .	10-21
Figure 10-14.	The Q-Rating System for Rock Mass Classification . . . . .	10-22
Figure 10-15.	Chart for Estimating the Geological Strength Index (GSI) . . . . .	10-23
Figure 10-16.	Material Constant $m_i$ for GSI Evaluation of Rock Mass Strength . . . . .	10-25
Figure 10-17.	Approximate Chart Solution for Obtaining Normalized Cohesion Intercept ( $c/F_u$ ) and Friction Angle ( $N_f$ ) from GSI Rating and $m_i$ Parameter . . . . .	10-26
Figure 10-18.	Allowable Bearing Stresses on Unweathered Rock from Codes . . . . .	10-28
Figure 10-19.	Allowable Bearing Stress on Fractured Rock from RQD . . . . .	10-28
Figure 10-20.	Unit Side Resistance Trend with Strength of Sedimentary Rocks . . . . .	10-29
Figure 10-21.	Shaft Unit Side Resistance with Various Rock Types . . . . .	10-29
Figure 10-22.	Rippability of Inplace Rock by Caterpillar Dozer Evaluate by P-Wave Velocity . . . . .	10-30
Figure 11-1.	Example <i>Table of Contents</i> for a Geotechnical Investigation (Data) Report .	11-3
Figure 11-2.	Example <i>Table of Contents</i> for a Geotechnical Design Report . . . . .	11-4
Figure 11-3.	Representative Test Location Plan of Completed Soil Boring Locations . . . .	11-7
Figure 11-4.	Plan Showing Proposed Boring and In-Situ Test Locations . . . . .	11-7
Figure 11-5.	Subsurface Profile Based on Boring Data Showing Cross-Sectional View . .	11-8
Figure 12-1.	Track-Mounted Drill Rig Investigating Bridge Site in Hayti, Missouri . . . . .	12-2

[Blank]



## Nomenclature & Symbols

" <sub>j</sub>	Joint dip direction
" <sub>s</sub>	Slope dip direction
\$	Average dip angle of rock bedding
\$ <sub>j</sub>	Joint dip
\$ <sub>s</sub>	Slope dip
( <sub>'</sub>	Buoyant (or effective or submerged) unit weight of geomaterial
(	Unit weight of soil
( <sub>d</sub> , (dry	Dry unit weight of soil
( <sub>dmax</sub>	Dry unit weight of soil in its densest state
( <sub>dmin</sub>	Dry unit weight of soil in its loosest state
( <sub>sat</sub>	Saturated unit weight of soil
( <sub>t</sub>	Total unit weight of soil
( <sub>w</sub>	Unit weight of water (9.81 kN/m <sup>3</sup> )
*	Horizontal movement of soil mass in a Direct Shear Test
) <sub>'</sub> , a	Change in axial strain
) <sub>F</sub>	Change in applied axial stress
) <sub>D</sub>	Change in diameter of rock sample
) <sub>e</sub>	Change in void ratio over ) p
) <sub>H</sub>	Vertical movement of soil mass in a Direct Shear Test
) <sub>H</sub>	Change in height of rock sample
) <sub>p</sub>	Additional loading due to foundation or embankment construction
) <sub>t</sub>	Time for standpipe head to fall
' <sub>a</sub> , ' axial	Axial strain in soil or rock sample ( ) H/H)
' <sub>r</sub> radial	Radial strain in rock sample ( ) D/D)
:	Viscosity of the permeant
: <sub>FV</sub>	Correction factor for vane shear strength to mobilized strength
<	Poisson's ratio
D	Resistivity; = 2BdV/I
F <sub>'</sub>	Effective stress
F	Normal stress
F <sub>1</sub> , F <sub>2</sub> , F <sub>3</sub>	Major, intermediate and minor total principal stresses, respectively.
F <sub>1r</sub> , F <sub>2r</sub> , F <sub>3r</sub>	Major, intermediate and minor effective principal stresses
F <sub>a(ult)</sub>	Uniaxial compressive strength of rock
F <sub>CIR</sub>	Uniaxial compressive strength of Intact Rock
F <sub>n</sub>	Normal stress on joint
F <sub>u</sub>	Applied axial stress
F <sub>v</sub>	Total overburden pressure
F <sub>vo</sub>	Total (vertical) overburden stress
F <sub>vo</sub> r	Effective (vertical) overburden stress
J	Shear stress
(J <sub>u</sub> ) <sub>corr</sub>	Corrected vane shear strength
(J <sub>u</sub> ) <sub>field</sub>	Vane shear strength measured in the field (uncorrected)
N <sub>'</sub>	Drained or effective friction angle of soil or rock

N	Angle of internal friction
$N_d$	Drained friction angle
$N_r$	Residual friction angle
A	Uncorrected pressure required to cause flat dilatometer diaphragm to just lift-off
A	Loaded area; Cross-sectional area of soil sample
A	Code for Auger sample to be entered in the “Samples Type” column of boring log
AASHTO	American Association of State Highway and Transportation Officials
ADSC	Association of Drilled Shaft Contractors
AQ Wireline	Designation of rock core barrel
ASTM	American Society for Testing and Materials
B	Bedding (used to describe type of discontinuity in rock core log)
B	Uncorrected pressure for 1.1 mm deflection of flat dilatometer membrane.
$B_f$	Width of footing
BHS	Code for Borehole shear test to be entered in the column of boring log
BQ	Dimension of rock core size
BX	Rock cored with BX core barrel, which obtains a 41 mm-diameter core
C	Code for Denison or pitcher-type core barrel sample
C	Code for consolidation test for “Samples Type” column of boring log
C	Close (used to describe discontinuity spacing in rock core log)
C	Uncorrected pressure during deflation of flat plate dilatometer membrane.
c	Shape factor
$c'$	Drained or effective cohesion intercept of soil or rock from drained lab shear test.
$C_c$	Coefficient of secondary consolidation
$C_c'$	Coefficient of secondary compression in terms of strain
$C_c^e$	Coefficient of secondary compression in terms of void ratio
$C_1$	Hazen’s coefficient
Ca	Calcite (used to describe type of infilling in rock core log)
CBR	California Bearing Ratio
$C_c$	Coefficient of curvature
$C_c$	(Virgin) Compression index
CD	Consolidated Drained
CDS	Completely Decomposed State
CH	Inorganic clays of high plasticity
Ch	Chlorite (used to describe type of infilling in rock core log)
$c_h$	Coefficient of horizontal consolidation
CL	Inorganic clays of low to medium plasticity
Cl	Clay (used to describe type of infilling in rock core log)
$c_o$	Cohesion of as-compacted soil
CP	Designation of rock core barrel
CPT	Cone Penetration Test
CR	Compression Ratio = $C_c'/(1+e)$
$C_r$	Recompression Index
$C_U$	Uniformity coefficient; = $D_{60}/D_{10}$
CU	Consolidated Undrained (Triaxial shear test)
$c_u$	Undrained shear strength
$c_v$	Coefficient of vertical consolidation

D	Original diameter of rock sample
D	Apparent diameter of the soil particles
d	Primary consolidation at a specific load level
d	Depth
d	Distance between electrodes in resistivity survey.
$D_{10}$	Grain size than which 10% of the sample is smaller
$D_{30}$	Grain size than which 30% of the sample is smaller
$D_{50}$	Mean Grain Size; size than which 50% of the sample is finer
$D_{60}$	Grain size than which 60% of the sample is smaller
$D_{max}$	Largest grain size in soil sample
$D_{min}$	Smallest grain size in soil sample
DMT	Flat plate dilatometer test
$D_r$	Relative density of soil
DS	Code for direct shear test to be entered in the “Other Tests” column of boring log
$D_s$	Effective particle diameter
DSS	Direct Simple Shear
E	Elastic or Young’s Modulus
e	Void ratio of soil
$E_{av}$	Average Young’s Modulus
$E_D$	Equivalent elastic modulus obtained from flat dilatometer.
$e_f$	Final void ratio
$E_M$	Menard modulus from standard (prebored) pressuremeter test.
$E_m$	In-situ modulus of deformation
$e_{max}$	Void ratio of soil in its loosest state
$e_{min}$	Void ratio of soil in its densest state
$e_o$	Initial void ratio of sample
$e_r$	Void ratio at beginning of rebound
EROS	Earth Resources Observations Systems
$E_s$	Secant Young’s Modulus
$E_t$	Tangent Young’s Modulus
EW	Designation of flush-joint casing
EX	Designation of rock core barrel
F	Friable (term to describe rock hardness)
F	Fault (used to describe type of discontinuity in rock core log)
F	Fines; Corresponding to percent soil passing No. 200 sieve
f	Shear wave frequency
Fe	Iron oxide (used to describe type of infilling in rock core log)
Fi	Filled (used to describe amount of infilling in rock core log)
Fo	Foliation (used to describe type of discontinuity in rock core log)
$f_s$	Measured sleeve friction during CPT
FV	Field Vane or Vane Shear Test
GC	Clayey gravels, poorly graded gravel-sand-clay
GI	Group index in the AASHTO soil classification system
GM	Silty gravels, poorly graded gravel-sand-silt
GP	Poorly graded clean gravels, gravel-sand mixture
GPR	Ground Penetrating Radar

$G_s$	Specific gravity of soil solids
GW	Well graded clean gravels, gravel-sand mixture
Gy	Gypsum/Talc (used to describe a special type of infilling in rock core log)
H	High modulus ratio
H	Healed (used to describe type of infilling in rock core log)
H	Differential head of pressure on the test section
H	Hard (term to describe rock hardness)
H	Half height of consolidation sample (Length of longest drainage path)
H	Original height of rock sample
$h_1, h_2$	Heads at times $t_1$ and $t_2$ , respectively
HQ	Dimension of rock core size
HW	Designation of drill rod
$i$	Angle of irregularities with average dip line
$I_{a(50)}$	Anisotropic point load strength index of rock specimen
$I_D$	Material index for obtaining soil type from flat plate dilatometer test.
$I_{d2}$	Slake-Durability Index
$I_p, PI$	Plasticity Index
Ir	Irregular (used to describe surface shape of joint in rock core log)
$I_s$	Point-load index
$I_{s(50)}$	Point load strength index of rock specimen with diameter = 50 mm
ISRM	International Society for Rock Mechanics
J	Joint (used to describe type of discontinuity in rock core log)
$J_a$	Joint alteration number in the Q System
JCS	Joint wall Compressive Strength
$J_r$	Joint roughness coefficient in the Q System
JRS	Joint Roughness Coefficient
$J_v$	Number of joints in unit volume of rock
$k$	Coefficient of permeability (hydraulic conductivity)
$K_D$	Lateral stress index from flat dilatometer.
$K_o$	Lateral stress coefficient for geostatic case.
L	Length of soil sample
L	Low modulus ratio
$L_f$	Length of footing
LFC	Length of fully cylindrical rock core piece
LH	Low hardness (term to describe rock hardness)
LI	Liquidity Index
LL	Liquid Limit
LPS	Latent Planes of Separation
LT	Length of rock core piece measured from tip to tip
M	Moderate (used to describe discontinuity spacing in rock core log)
M	Average modulus ratio
M	Mechanical (sieve or hydrometer) analysis
MFS	Micro Fresh State
MH	Inorganic clayey silts, elastic silts
MH	Moderately Hard (term to describe rock hardness)

ML	Inorganic silts and very fine sands, rock flour, silty or clayey fine sands or clayey silts (Group symbol in Unified Soil Classifications System)
ML-CL	Mixtures of inorganic silts and clays
MW	Moderately wide (used to describe discontinuity width in rock core log)
N	Uncorrected Standard Penetration Test N-value (or blow counts).
n	Porosity
$N_1$	N-value normalized to an effective overburden stress of 1 atmosphere
$N_{60}$	SPT N-value corrected for energy to average 60% standard of practice.
$(N_1)_{60}$	SPT N-value corrected to 60% energy efficient and stress-normalized.
NC	Normally Consolidated
$N_{corr}$	N-value of saturated fine or silty sands corrected for pore pressure
$N_{field}$	N-value measured in the field
NGI	Norwegian Geotechnical Institute
No	None (used to describe amount or type of infilling in rock core log)
NQ	Dimension of rock core size
NR	No recovery of sample
NV	Designation of rock core barrel
NW	Designation of drill rod
NX	Rock cored with NX core barrel, which obtains a 53 mm-diameter core
OC	Overconsolidated
OCR	Overconsolidation Ratio
OH	Organic clays of medium to high plasticity, organic salts (Group symbol in Unified Soil Classifications System)
OL	Organic silts and organic silty clays of low plasticity (Group symbol in Unified Soil Classifications System)
OMC	Optimum Moisture Content
P	Piezometer
P	Code for thin-wall tube sample in the “Samples Type” column of boring log
$p_1$	Pressure B corrected for diaphragm stiffness in flat dilatometer test.
Pa	Partially filled (used to describe amount of infilling in rock core log)
$p_c$	Preconsolidation stress
PDS	Partly Decomposed State
$p_f$	Creep pressure during Menard-type pressuremeter test
PI	= $LL - PL$ ; Plasticity index
PL	Plastic Limit
$p_l$	Limit pressure during Menard-type pressuremeter test
PLT	Point Load Test
PMT	Pressuremeter Test
$P_o$	Pressure corresponding to volume $V_o$ during Menard-type pressuremeter test
$p_o$	Pressure A corrected for diaphragm stiffness in flat dilatometer tes.
PQ	Dimension of rock core size
Ps	Code for piston sample to be entered in the “Samples Type” column of boring log
Pt	Peat and other highly organic soils
PVC	Poly-vinyl chloride
PW	Designation of flush-joint casing
Py	Pyrite (used to describe type of infilling in rock core log)

Q	Constant rate of flow of water into the hole; Total discharge volume
$q_c$	Uncorrected cone tip resistance measured during CPT
$q_t$	Corrected cone tip stress or resistance during CPT
$q_u$	Unconfined compressive strength; Uniaxial compressive strength of rock
Qz	Quartz (used to describe type of infilling in rock core log)
R	Rough (used to describe roughness of surface in rock core log)
R	Shale rating
r	Radius of the test borehole
R-value	Value of resistance of the soil to lateral deformation when a vertical load acts on it
RMR	Rock Mass Rating
RQD	Rock Quality Designation
RR	Recompression Ratio = $C_r/(1+e)$
RW	Designation of drill rod
RW	Designation of flush-joint casing
S	Degree of saturation of soil
S	Smooth (used to describe roughness of surface in rock core log)
SC	Clayey sands, poorly graded sand-clay mixture
Sd	Sand (used to describe type of infilling in rock core log)
SDI	Slake Durability Index
Sh	Shear (used to describe type of discontinuity in rock core log)
SL	Shrinkage limit
Slk	Slickensided (used to describe roughness of surface in rock core log)
SM	Silty sands, poorly graded sand-silt mixture
SM-SC	Sand-silt-clay with slightly plastic fines
SMR	Slope rock Mass Rating
SP	Poorly graded clean sands, sand-gravel mixture
Sp	Spotty (used to describe amount of infilling in rock core log)
SPB	Preferred Breakage
SPT	Standard Penetration Test
SR	Slightly rough (used to describe roughness of surface in rock core log)
SRB	Random Breakage
SRS	Shale Rating System
SS	Code for standard spoon sample in the “Samples Type” column of boring log
St	Stepped (used to describe surface shape of joint in rock core log)
STS	Stained State
Su	Surface stain (used to describe amount of infilling in rock core log)
$s_u$	Undrained shear strength
$s_{uv}$	Vane shear strength (uncorrected)
$s_u/F_{vo}r$	Normalized undrained shear strength to effective overburden stress ratio.
SW	Well-graded sands, gravelly sands, little or no fines (Group symbol in USCS).
SW	Designation of flush-joint casing
T	Code for triaxial compression test in the “Other Tests” column of boring log
T	Topping failure; Tight (used to describe discontinuity width in rock core log)
T	Shear force on soil in a Direct Shear Test
t	Time
$t_{100}$	Time required for 100% consolidation at a specific load level

$t_{50}$	Time required for 50% consolidation at a specific load level
TV	Code for torvane index in the “Other Tests” column of boring log
U	Code for unconfined compression test in the “Other Tests” column of boring log
u	Porewater pressure
$u_1$	Porewater pressure during type 1 piezocone (midface element)
$u_2$	Porewater pressure during type 2 piezocone (shoulder element)
$u_o$	In-situ hydrostatic porewater pressure
USCS	Unified Soil Classification System
UU	Unconsolidated Undrained
UW	Designation of flush-joint casing
V	Potential drop in resistivity surveys
V	Vein (used to describe type of discontinuity in rock core log)
VC	Very close (used to describe discontinuity spacing in rock core log)
$V_c$	Initial volume of probe during Menard’s pressuremeter test
$V_f$	volume corresponding to creep pressure $p_f$ during Menard’s pressuremeter test
VH	Very hard (term to describe rock hardness)
$V_m$	( $V_o + V_f$ ) during Menard pressuremeter test
VN	Very narrow (used to describe discontinuity width in rock core log)
$v_o$	Difference between the volume of the hole and $v_c$
VR	Very rough (used to describe roughness of surface in rock core log)
$V_s$	Shear wave velocity
W	Wide (used to describe discontinuity width in rock core log)
W	Code for unit weight and water content in the “Other Tests” column of boring log
w	Natural moisture content
Wa	Wavy (used to describe surface shape of joint in rock core log)
$W_n$	Natural water content
X	Distance
X	Code for special tests performed in the “Other Tests” column of boring log
ZW	Designation of flush-joint casing
z	Depth (below ground)

[Blank]



## CHAPTER 1.0

### INTRODUCTION

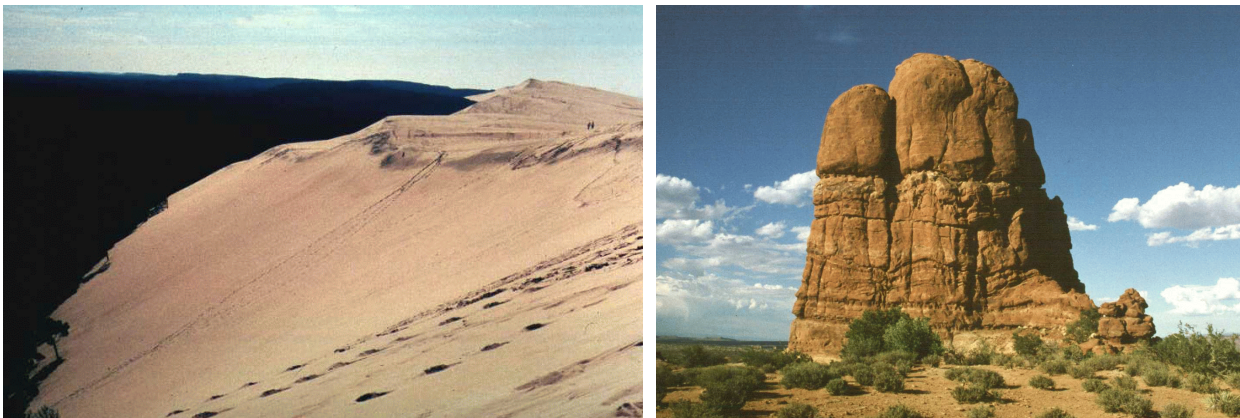
#### 1.1 SCOPE OF THIS MANUAL

All transportation systems are built either on earth, in earth, and/or with earth. To the transportation facility designer and builder, geomaterials (soil and rock) not only form the foundation for their structures but they also constitute a large portion of the construction materials.

Unlike manufactured construction materials, the properties of soil and rock are the results of the natural processes that have formed them, and natural or man-made events following their formation. The replacement of inferior foundation materials often is impractical and uneconomical. The large volume of soil and rock needed for construction of transportation facilities, as a rule, makes it prohibitive to manufacture and transport pre-engineered materials. The geotechnical engineer in designing and constructing transportation facilities is faced with the challenge of using the foundation and construction materials available on or near the project site. Therefore, the designing and building of such structures requires a thorough understanding of properties of available soils and rocks that will constitute the foundation and other components of the structures.

This manual presents the general state of the practice of subsurface exploration and focuses on the scope and specific elements of typical geotechnical investigation programs for design and construction of highways and related transportation facilities. The manual presents the latest methodologies in the planning, execution, and interpretation of the various exploratory investigation methods, and the development of appropriate soil and rock parameters for engineering applications. It is understood that the procedures discussed in the manual are subject to local variations. It is important, therefore, for the reader to become thoroughly familiar with the local practices as well.

It must be pointed out that the term structure in this course and manual is used to imply engineered & constructed facilities such as embankments, pavements, bridges, walls, and other built facilities.



**Figure 1-1. Natural Geomaterials: (a) Atlantic Dune Sand Deposits; (b) Sandstone in Moab, UT.**

## 1.2 GEOTECHNICAL ENGINEER'S ROLE IN SUBSURFACE EXPLORATION

The role of the geotechnical engineer<sup>1</sup> in design and construction varies according to the distribution of responsibilities in an organization. Nevertheless, by definition, the geotechnical engineer, among others, is responsible for acquiring and interpreting soil, rock, and foundation data for design and construction of various types of structures. The proper execution of this role requires a thorough understanding of the principles and practice of geotechnical engineering, subsurface investigation techniques and principles, design procedures, construction methods and planned facility utilization supplemented with a working knowledge of geology and hydrology.

The proper discharge of the geotechnical engineer's duties requires that he or she be involved from the very beginning of the planning stage of a project. A geotechnical engineer may provide, based on prior knowledge and research for example, guidance in the location of a proposed tunnel or road which may result in reduced cost, improved constructibility and other advantages. When the services of the geotechnical engineer are introduced into the project after the final project location is determined, a very important value engineering benefit may be missed.

Once the project location, geometry and other attributes are determined, the geotechnical engineer and the design team should jointly define the subsurface exploration needs. The geotechnical engineer should be given the responsibility and the authority to make decisions involving the details of the subsurface investigation based on his or her knowledge of the site conditions and on information gathered during the construction. It is the responsibility of the geotechnical engineer to direct the collection of existing data, to conduct field reconnaissance, to initiate the subsurface investigation, and to review its progress. When unusual or unexpected conditions are encountered during the investigation, the field geotechnical engineer should communicate these findings to the design engineer, make recommendations and implement changes as needed.

Once the samples are obtained, the geotechnical engineer must visually examine all or a representative number of the samples to have a "feel" of the material properties as a tool for determining the adequacy of the investigative program. This is an often ignored practice that may lead to misunderstandings and costly errors. Once the field investigation has progressed sufficiently to define the general stratigraphy and subsurface materials at the site, a site-specific testing program for the project can be initiated.

Having obtained the data from the field investigation and laboratory testing program, the focus of the geotechnical engineer's efforts turn to the reduction and evaluation of these data, the definition of subsurface stratification and groundwater conditions, the development of appropriate soil and rock design parameters, and the presentation of the investigation findings in a geotechnical report. The geotechnical engineer uses this acquired subsurface information in the analysis and design of foundations and other geotechnical elements of a highway project.

---

<sup>1</sup> The term geotechnical engineering in this manual also applies to engineering geologists who are involved in subsurface investigations for civil engineering applications.

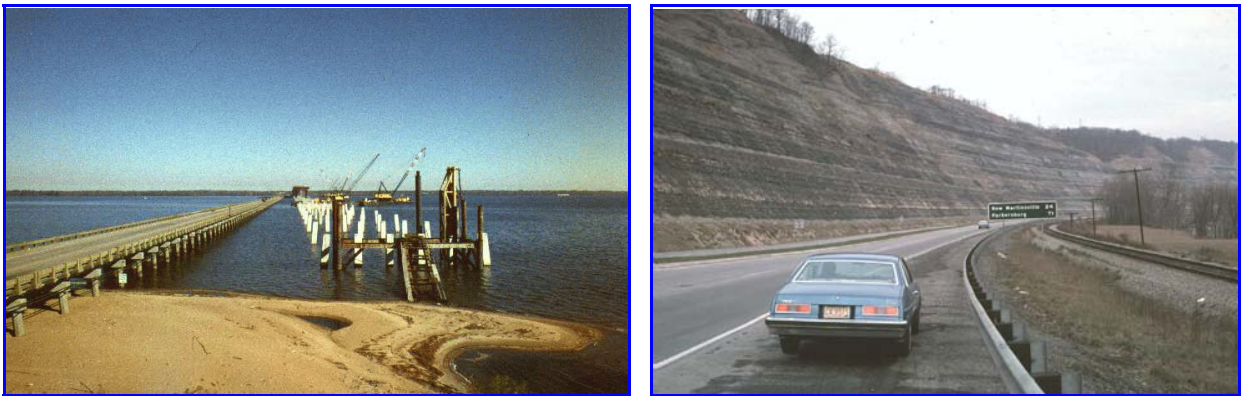
## CHAPTER 2.0

### PROJECT INITIATION

#### 2.1 PROJECT TYPE

##### 2.1.1 New Construction

In general there are two types of subsurface investigation that new construction may require; the first being a conceptual subsurface investigation, or route selection study, where the geotechnical engineer is asked by the designers to identify the best of several possible routes or locations for the proposed structures, or to evaluate foundation alternatives. This type of project generally does not require a detailed subsurface investigation. It is normally limited to geologic reconnaissance and some sampling, field identification of subsurface conditions to achieve generalized site characterization, and general observations such as the depth to rock or competent soils, presence of sinkholes and/or solution cavities, organic deposits in low lying swampy areas, and/or evidence of old fill, debris, or contamination. Conceptual study investigations require limited laboratory testing and largely depend on the description of subsurface conditions from boring logs prepared by an experienced field engineer and/or geologist. Properly performed exploratory investigations, in cases where the designers have flexibility in locating the project to take advantage of favorable subsurface conditions, have the potential for resulting in substantial savings by avoiding problematic foundation conditions and costly construction methods.



**Figure 2-1. New Highway Construction: (a) Pile Bent Bridge in NC and (b) Cut Slope in VA.**

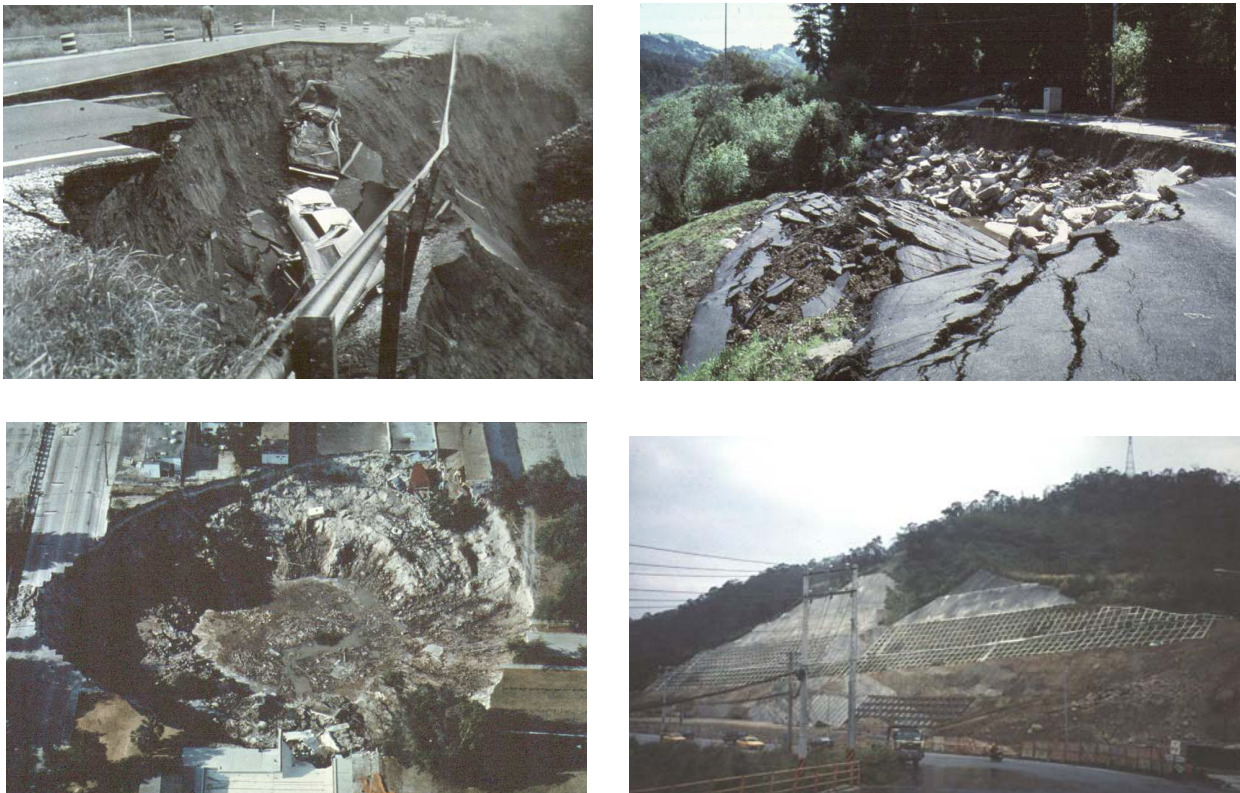
The second and more common type of subsurface investigation is the detailed investigation to be performed for the purpose of detailed site characterization to be used for design (Figure 2-1). Frequently, the design phase investigation is performed in two or more stages. The initial, or preliminary design, stage investigation is typically performed early in the design process prior to defining the proposed structure elements or the specific locations of foundations, embankments or earth retaining structures. Accordingly, the preliminary design investigation typically includes a limited number of borings and testing sufficient for defining the general stratigraphy, soil and rock characteristics, groundwater conditions, and other existing features of importance to foundation design. Subsequently, after the location of structure foundations and other design elements have been determined, a second, or final design, phase investigation is frequently performed to obtain site specific subsurface information at the final substructure locations for design purposes and to

reduce the risk of unanticipated ground conditions during construction. Further investigation stages can be considered if there are significant design changes or if local subsurface anomalies warrant further study. When properly planned, this type of multi-phase investigation provides sufficient and timely subsurface information for each stage of design while limiting the risk and cost of unnecessary explorations.

Prior to planning and initiating the investigation, the geotechnical engineer needs to obtain from the designers the type, load and performance criteria, location, geometry and elevations of the proposed facilities. The locations and dimensions of cuts and fills, embankments, retaining structures, and substructure elements should be identified as accurately as practicable. Bridge locations, approaches, and types of bridge construction should be provided in sufficient detail to allow a determination of the locations, depths, type, and number of borings to be performed. In cases where the investigation is being done for buildings, such as toll plazas, tourist information centers, and recreational or rest facilities, the designers should provide the layout and footprint of the building, plans, and any column and wall loads.

### 2.1.2 Rehabilitation Projects

Many geotechnical investigations involve rehabilitation and remediation of highway projects, including landslide failures, embankment stability, slope stabilization, subgrade & pavement settlement, and replacement of old foundation systems (see Figure 2-2).



**Figure 2-2. Rehabilitation Projects Including: (a) Highway Slope Failure Involving Loss of Life; (b) Roadway Landslide; (c) Sinkhole in Orlando, Florida; and (d) Slope Stabilization.**

The detail required for the subsurface investigation of rehabilitation projects depends on a number of variables, including:

- ' The condition of the facility to be rehabilitated.
- ' If the facility is distressed, the nature of distress (pavement failure, deep seated failures, structure settlement, landslides, drainage and water flow, imminent collapse)
- ' Whether the facility will be returned to its original and as-built condition or will be upgraded, say adding another lane to a pavement or a bridge.
- ' If facilities will be upgraded, the proposed geometry, location, loadings and structure changes (i.e. culvert to bridge).
- ' The required design life of the rehabilitated facility.

The above information should be obtained to aid in planning an appropriate investigation program.

### **2.1.3 Contaminated Sites**

The geotechnical engineer occasionally must perform subsurface investigations at sites with contaminated soils or groundwater. Contamination may be of a non-hazardous or hazardous nature. Sampling and handling of contaminated samples is a complicated topic which is beyond the scope of this course. However, it is necessary for all involved in geotechnical investigations to be aware of the salient points of these procedures. The US Environmental Protection Agency (EPA) document number 625/12-91/002 titled "Description and Sampling of Contaminated Soils - A Field Pocket Guide" contains guidelines and background information, and a list of useful references on the topic.

When an investigation is to be performed, acquisition records for newly obtained right-of-way (ROW) will indicate the most recent land use for the area. Furthermore, the environmental section of the agency will most probably have developed environmental impact statements (EIS) and will have identified contaminated areas and the type of contamination. The ROW and environmental sections of the agency should be routinely contacted for this information at the investigation planning stage. On rehabilitation projects where the only planned activities will be on the existing ROW the information available may vary from very complete to none. Old gravel or compacted soil roads have occasionally been constructed using waste products as dust palliatives, and where these roads were later covered with, say bituminous hot mix concrete, the subsurface exploration may encounter layers of contaminated soils. Also, there may be a risk of contaminant migration through groundwater movement from off-site sources.

Some signs of possible contamination are:

- C Prior land use (e.g. old fill, landfills, gas stations, etc.).
- C Stained soil or rock.
- C Apparent lack of vegetation or presence of dead vegetation and trees.

- C Odors (It should be noted that highly organic soils often will have a rotten egg odor which should not be construed as evidence of contamination. However, this odor may also be indicative of highly toxic hydrogen sulfide. Drilling crews should be instructed as such).
- C Presence of liquids other than groundwater or pore water.
- C Signs of prior ground fires (at landfill sites). Established landfills will emit methane gas which is colorless and odorless, and in high concentrations in the presence of sparks or fire it will explode. At low concentrations under certain conditions (i.e. lightning) it will burn. Areas containing natural organic deposits also produce and emit methane gas.
- C Presence of visible elemental metals (i.e., mercury).
- C Low (<2.5) or High (>12.5) pH.

Easy to use field testing equipment such as air quality monitoring devices, pH measurement kits, photoionization detectors, etc. can be used to perform preliminary tests to identify the presence of some contaminants.

EPA documents provide guidelines and protocols for sampling, packaging, and transporting of contaminated soils as well as for field and laboratory testing. Additionally, many states have developed their own protocols, some of which are stricter than the ones developed by EPA. These documents need to be consulted prior to any attempt to sample or test suspect materials.

In most environmental applications, the US Department of Agriculture Soil Conservation Service (SCS) taxonomy rather than geotechnical engineering classifications are applied. A complete reference work to SCS soil taxonomy is “The Agricultural Handbook No. 18” published by the Soil Conservation Service, Washington, D.C. Copies of this handbook can be obtained through state or regional offices of SCS.

## **2.2 EXISTING DATA SOURCES**

The first step in the investigation process is the review of existing data. There are a number of very helpful sources of data that can and should be used in planning subsurface investigations. Review of this information can often minimize surprises in the field, assist in determining boring locations and depths, and provide very valuable geologic and historical information which may have to be included in the geotechnical report.

Following is a partial list of useful sources of geological, historical, and topographic information. Specific information available from these and other reference sources is presented in the U.S. Navy Design Manual 7.1 (1982).

- C Prior subsurface investigations (historical data) at or near the project site.
- C Prior construction and records of structural performance problems at the site (i.e. pile length, driveability problems, rock slides, excessive seepage, unpredicted settlement, and other information). Some of this information may only be available in anecdotal forms. The more serious ones should be investigated, documented if possible, and evaluated by the engineer.
- C U.S. Geological Survey (USGS) maps, reports, publications, and websites ([www.usgs.gov](http://www.usgs.gov)).
- C State Geological Survey maps, reports, and publications.

- C State flood zone maps prepared by state or U.S. Geological Survey or the Federal Emergency Management Agency (FEMA: [www.fema.gov](http://www.fema.gov)) can be obtained from local or regional offices of these agencies.
- C Department of Agriculture Soil Conservation Service (SCS) Soil Maps - A list of published soil surveys is issued annually. It should be noted that these are well researched maps but they only provide detailed information for shallow surficial deposits. They may show frost penetration depths, drainage characteristics, USDS soil types, and agrarian data.
- C Geological Societies (Association of Engineering Geologists, Association of American State Geologists).
- C Local university libraries and geology departments.
- C Public Libraries and the Library of Congress.
- C Earthquake data, seismic hazards maps, fault maps, and related information prepared by:
  - U.S. Geological Survey (USGS).
  - Earthquake Engineering Research Center (EERC), University of California, Berkeley.
  - Earthquake Engineering Research Institute (EERI), Stanford University
  - National Earthquake Engineering Research Program (NEERP), Washington, D.C.
  - Multidisciplinary Center of Earthquake Engineering Research (MCEER), Buffalo, N.Y.
  - Advanced Technology Council (ATC), Redwood City, California
  - Mid-America Earthquake Center (MAEC), Univ. of Illinois, Urbana.
  - Pacific Earthquake Engineering Center (PEER), Univ. of California-Berkeley.
- C Worldwide National Earth-Science Agencies (USGS Circular 716, 1975).
- C U.S. Bureau of Mines (USBM)
- C State, City, and County Road Maps
- C Aerial Photographs (USGS, SCS, Earth Resource Observation System).
- C Remote Sensing Images (LANDSAT, Skylab, NASA).
- C Site Plans showing locations of ditches, driveways, culverts, utilities, and pipelines.
- C Maps of streams, rivers and other water bodies to be crossed by bridges, culverts, etc., including bathimetric data.

The majority of the above information can be obtained from commercial sources (i.e. duplicating services) or U.S. and state government local or regional offices. Specific sources (toll free phone numbers, addresses etc.) for flood and geologic maps, aerial photographs, USDA soil surveys, can very quickly identified through the Internet.

### **2.3 SITE VISIT/PLAN-IN-HAND**

It is imperative that the geotechnical engineer, and if possible the project design engineer, conducts a reconnaissance visit to the project site to develop an appreciation of the geotechnical, topographic, and geological features of the site and become knowledgeable of access and working conditions. The plan-in-hand site visit is a good opportunity to learn about:

- C Design and construction plans
- C General site conditions
- C Geologic reconnaissance
- C The geomorphology
- C Access restrictions for equipment
- C Traffic control requirements during field investigations
- C Location of underground and overhead utilities
- C Type and condition of existing facilities (i.e. pavements, bridges, etc.)
- C Adjacent land use (schools, churches, research facilities, etc.)
- C Restrictions on working hours
- C Right-of-way constraints
- C Environmental issues
- C Escarpments, outcrops, erosion features, and surface settlement
- C Flood levels
- C Water traffic and access to water boring sites
- C Benchmarks and other reference points to aid in the location of boreholes
- C Equipment storage areas/security

### **2.4 COMMUNICATION WITH DESIGNERS/PROJECT MANAGERS**

The geotechnical engineer should have periodic discussions with the field inspector while the investigation program is ongoing. He or she should notify the project or the design engineer of any unusual conditions or difficulties encountered, and any changes made in the investigation program or schedule. The frequency of these communications depends on the critical nature of the project, and on the nature and seriousness of the problems encountered. A useful *Field Instructions Form* which can be used to clearly communicate the general requirements of the investigation program to all field personnel is shown below in Figure 2-3.



**Geotechnical Project Information**

Project No.: \_\_\_\_\_

Name: \_\_\_\_\_

Location: \_\_\_\_\_

Site Contact (Project Engineer): \_\_\_\_\_ Phone: \_\_\_\_\_

Utility Contact: \_\_\_\_\_ Reference No.: \_\_\_\_\_

Right of Entry Contact: \_\_\_\_\_

Other Contact (specify): \_\_\_\_\_ Home Phone: \_\_\_\_\_

Estimated Time: \_\_\_\_\_

**Soil Test Boring & Drilling Information**

Boring No.	Depth	Drilling Sequence	Sampling	Remarks (piezometers, water levels, etc.)

Health and Safety Provisions: Special Plan: \_\_\_\_\_

Sample type, frequency: \_\_\_\_\_

Disposal of Cuttings/Drill Fluids: \_\_\_\_\_

Boring Closure: Cuttings: \_\_\_\_\_ Grout: \_\_\_\_\_

Remarks: \_\_\_\_\_

\_\_\_\_\_

\_\_\_\_\_

\_\_\_\_\_

\_\_\_\_\_

**Figure 2-3. Example *Field Instructions Form* for Geotechnical Investigations.**

## **2.5 SUBSURFACE EXPLORATION PLANNING**

Following the collection and evaluation of available information from the above sources, the geotechnical engineer is ready to plan the field exploration program. The field exploration methods, sampling requirements, and types and frequency of field tests to be performed will be determined based on the existing subsurface information, project design requirements, the availability of equipment, and local practice. The geotechnical engineer should develop the overall investigation plan to enable him or her to obtain the data needed to define subsurface conditions and perform engineering analyses and design. A geologist can often provide valuable input regarding the type, age and depositional environment of the geologic formations present at the site for use in planning and interpreting the site conditions.

Frequently, the investigation program must be modified after initiating the field work because of site access constraints or to address variations in subsurface conditions identified as the work proceeds. To assure that the necessary and appropriate modifications are made to the investigation program, it is particularly important that the field inspector (preferably a geotechnical engineer or geologist) be thoroughly briefed in advance regarding the nature of the project, the purpose of the investigation, the sampling and testing requirements, and the anticipated subsurface conditions. The field inspector is responsible for verifying that the work is performed in accordance with the program plan, for communicating the progress of the work to the project geotechnical engineer, and for immediately informing the geotechnical engineer of any unusual subsurface conditions or required changes to the field investigation. Table 2-1 lists the general guidelines to be followed by the geotechnical field inspectors.

### **2.5.1 Types of Investigation**

Generally, there are five types of field subsurface investigation methods, best conducted in this order:

1. Remote sensing
2. Geophysical investigations
3. Disturbed sampling
4. In-situ testing
5. Undisturbed sampling

#### **Remote Sensing**

Remote sensing data can effectively be used to identify terrain conditions, geologic formations, escarpments and surface reflection of faults, buried stream beds, site access conditions and general soil and rock formations. Remote sensing data from satellites (i.e LANDSAT images from NASA), aerial photographs from the USGS or state geologists, U.S. Corps of Engineers, commercial aerial mapping service organizations can be easily obtained, State DOTs use aerial photographs for right-of-way surveys and road and bridge alignments, and they can make them available for use by the geotechnical engineers.

The geotechnical engineer needs to be familiar with these sampling, investigation and testing techniques, as well as their limitations and capabilities before selecting their use on any project. The details of these investigation methods will be presented in subsequent chapters of this module.

**TABLE 2-1.**

**GENERAL GUIDELINES FOR GEOTECHNICAL FIELD INSPECTORS**

---

Fully comprehend purpose of field work to characterize the site for the intended engineering applications.:

- C Be thoroughly familiar with the scope of the project, technical specifications and pay items (keep a copy of the boring location plan and specifications in the field).
  - C Be familiar with site and access conditions and any restrictions.
  - C Review existing subsurface and geologic information before leaving the office.
  - C Constantly review the field data obtained as it relates to the purpose of the investigation.
  - C Maintain daily contact with the geotechnical project engineer; brief him/her regarding work progress, conditions encountered, problems, etc.
  - C Fill out forms regularly (obtain sufficient supply of forms, envelopes, stamps if needed before going to the field). Typical forms may include:
    - Daily field memos
    - Logs of borings, test pits, well installation, etc.
    - Subcontract expense report - fill out daily, co-sign with driller
  - C Closely observe the driller's work at all times, paying particular attention to:
    - Current depth (measure length of rods and samplers)
    - Drilling and sampling procedures
    - Any irregularities, loss of water, drop of rods, etc.
    - Count the SPT blows and blows on casing
    - Measure depth to groundwater and note degree of sample moisture
  - C Do not hesitate to question the driller or direct him to follow the specifications
  - C Classify soil and rock samples; put soil samples in jars and label them; make sure rock cores are properly boxed, photographed, stored and protected.
  - C Verify that undisturbed samples are properly taken, handled, sealed, labeled and transported.
  - C Do not divulge information to anyone unless cleared by the geotechnical project engineer or the project manager.
  - C Bring necessary tools to job (see Table 2-4).
  - C Take some extra jars of soil samples back to the office for future reference.
  - C Do not hesitate to stop work and call the geotechnical project engineer if you are in doubt or if problems are encountered.
  - C **ALWAYS REMEMBER THAT THE FIELD DATA ARE THE BASIS OF ALL SUBSEQUENT ENGINEERING DECISIONS AND AS SUCH ARE OF PARAMOUNT IMPORTANCE.**
-

## Geophysical Investigation

Some of the more commonly-used geophysical tests are surface resistivity (SR), ground penetrating radar (GPR), and electromagnetic conductivity (EM) that are effective in establishing ground stratigraphy, detecting sudden changes in subsurface formations, locating underground cavities in karst formations, or identifying underground utilities and/or obstructions. Mechanical waves include the compression (P-wave) and shear (S-wave) wave types that are measured by the methods of seismic refraction, crosshole, and downhole seismic tests and these can provide information on the dynamic elastic properties of the soil and rock for a variety of purposes. In particular, the profile of shear wave velocity is required for seismic site amplification studies of ground shaking, as well as useful for soil liquefaction evaluations.

## Disturbed Sampling

Disturbed samples are obtained to determine the soil type, gradation, classification, consistency, density, presence of contaminants, stratification, etc. Disturbed samples may be obtained by hand excavating methods by picks and shovels, or by truck-mounted augers and other rotary drilling techniques. These samples are considered “disturbed” since the sampling process modifies their natural structure.

## In-Situ Investigation

In-situ testing and geophysical methods can be used to supplement soil borings. Certain tests, such as the electronic cone penetrometer test (CPT), provide information on subsurface soils without sampling disturbance effects with data collected continuously on a real time basis. Stratigraphy and strength characteristics are obtained as the CPT progresses in the field. Since all measurements are taken during the field operations and there are no laboratory samples to be tested, considerable time and cost savings may be appreciated. In-situ methods can be particularly effective when they are used in conjunction with conventional sampling to reduce the cost and the time for field work. These tests provide a host of subsurface information in addition to developing more refined correlations between conventional sampling, testing and in-situ soil parameters.

## Undisturbed Sampling

Undisturbed samples are used to determine the in place strength, compressibility (settlement), natural moisture content, unit weight, permeability, discontinuities, fractures and fissures of subsurface formations. Even though such samples are designated as “undisturbed,” in reality they are disturbed to varying degrees. The degree of disturbance depends on the type of subsurface materials, type and condition of the sampling equipment used, the skill of the drillers, and the storage and transportation methods used. **As will be discussed later, serious and costly inaccuracies may be introduced into the design if proper protocol and care is not exercised during recovery, transporting or storing of the samples.**

### 2.5.2 Frequency and Depth of Borings

The location and frequency of sampling depends on the type and critical nature of the structure, the soil and rock formations, the known variability in stratification, and the foundation loads. While the rehabilitation of an existing pavement may require 4 m deep borings only at locations showing signs of distress, the design and construction of a major bridge may require borings often in excess of 30 m. Table 2-2 provides guidelines for selecting minimum boring depths, frequency and spacing for various geotechnical features. Frequently, it may be necessary or desirable to extend borings beyond the minimum depths to better define the geologic setting at a project site, to determine the depth and engineering characteristics of soft underlying

**TABLE 2-2.**

**MINIMUM REQUIREMENTS FOR BORING DEPTHS**

Areas of Investigation	Recommended Boring Depth
<p>Bridge Foundations* Highway Bridges</p> <p>1. Spread Footings</p> <p>2. Deep Foundations</p>	<p>For isolated footings of breadth <math>L_f</math> and width <math>\neq 2B_f</math>, where <math>L_f \neq 2B_f</math>, borings shall extend a minimum of two footing widths below the bearing level.</p> <p>For isolated footings where <math>L_f \geq 5B_f</math>, borings shall extend a minimum of four footing widths below the bearing level.</p> <p>For <math>2B_f \neq L_f \neq 5B_f</math>, minimum boring length shall be determined by linear interpolation between depths of <math>2B_f</math> and <math>5B_f</math> below the bearing level.</p> <p>In soil, borings shall extend below the anticipated pile or shaft tip elevation a minimum of 6 m, or a minimum of two times the maximum pile group dimension, whichever is deeper.</p> <p>For piles bearing on rock, a minimum of 3 m of rock core shall be obtained at each boring location to verify that the boring has not terminated on a boulder.</p> <p>For shafts supported on or extending into rock, a minimum of 3 m of rock core, or a length of rock core equal to at least three times the shaft diameter for isolated shafts or two times the maximum shaft group dimension, whichever is greater, shall be extended below the anticipated shaft tip elevation to determine the physical characteristics of rock within the zone of foundation influence.</p>
Retaining Walls	<p>Extend borings to depth below final ground line between 0.75 and 1.5 times the height of the wall. Where stratification indicates possible deep stability or settlement problem, borings should extend to hard stratum.</p> <p>For deep foundations use criteria presented above for bridge foundations.</p>
Roadways	Extend borings a minimum of 2 m below the proposed subgrade level.
Cuts	Borings should extend a minimum of 5 m below the anticipated depth of the cut at the ditch line. Borings depths should be increased in locations where base stability is a concern due to the presence of soft soils, or in locations where the base of the cut is below groundwater level to determine the depth of the underlying pervious strata.
Embankments	Extend borings a minimum depth equal to twice the embankment height unless a hard stratum is encountered above this depth. Where soft strata are encountered which may present stability or settlement concerns the borings should extend to hard material.
Culverts	Use criteria presented above for embankments.
*Note: Taken from AASHTO Standard Specifications for Design of Highway Bridges	

soil strata, or to assure that sufficient information is obtained for cases when the structure requirements are not clearly defined at the time of drilling. Generally it should be assumed that the structure may have an influence on the supporting subgrade soils down to a depth of twice the foundation width for static loads and four times the foundation width for seismic loads. Where borings are drilled to rock and this rock will impact foundation performance, it is generally recommended that a minimum 1.5-m length of rock core be obtained to verify that the boring has indeed reached bedrock and not terminated on the surface of a boulder. Where structures are to be founded directly on rock, the length of rock core should be not less than 3 m, and extended further if the use of socketed piles or drilled shafts are anticipated. Selection of boring depths at river and stream crossings must consider the potential scour depth of the stream bed.

The frequency and spacing of borings will depend on the variability of subsurface conditions, type of facility to be designed, and the investigative phase being performed. For conceptual design or route selection studies, very wide boring spacing (up to 300 m, or more) may be acceptable particularly in areas of generally uniform or simple subsurface conditions. For preliminary design purposes a closer spacing is generally necessary, but the number of borings would be limited to that necessary for making basic design decisions. For final design, however, relatively close spacings of borings may be required, as suggested in Table 2-3.

Subsurface investigation programs, regardless to how well they may be planned, must be flexible to adjust to variations in subsurface conditions encountered during drilling. The project geotechnical engineer should at all times be available to confer with the field inspector. On critical projects, the geotechnical engineer should be present during the field investigation. He/she should also establish communication with the design engineer to discuss unusual field observations and changes to be made in the investigation plans.

### **2.5.3 Boring Locations and Elevations**

It is generally recommended that a licensed surveyor be used to establish all planned drilling locations and elevations. For cases where a surveyor cannot be provided, the field inspector has the responsibility to locate the borings and to determine ground surface elevations at an accuracy appropriate to the project needs. Boring locations should be taped from known site features to an accuracy of about  $\pm 1.0$  m for most projects. Portable global positioning systems (GPS) are also of value in documenting locations. When a topographic survey is provided, boring elevations can be established by interpolation between contours. This method of establishing boring elevations is commonly acceptable, but the field inspector must recognize that the elevation measurement is sensitive to the horizontal position of the boring. Where contour intervals change rapidly, the boring elevations should be determined by optical survey.

A reference benchmark (BM) should be indicated on the site plans and topographic survey. If a BM is not shown, a temporary benchmark (TBM) should be established on a permanent feature (e.g., manhole, intersection of two streets, fire hydrant, or existing building). A TBM should be a feature that will remain intact during future construction operations. Typically, the TBM is set up as an arbitrary elevation (unless the local ground elevation is uniform). Field inspectors should always indicate the BM and/or TBM that was used on the site plan.

An engineer's level may be used to determine elevations. The level survey should be closed to confirm the accuracy of the survey. Elevations should be reported on the logs to the nearest tenth of a meter unless other directions are received from the designers. In all instances, the elevation datum must be identified and recorded. Throughout the boring program the datum selected should remain unchanged.

### **2.5.4 Equipment**

A list of equipment commonly needed for field explorations is presented in Table 2-4.

**TABLE 2-3.**

**GUIDELINES FOR BORING LAYOUT\***

<i>Geotechnical Features</i>	<i>Boring Layout</i>
Bridge Foundations	<p>For piers or abutments over 30 m wide, provide a minimum of two borings.</p> <p>For piers or abutments less than 30 m wide, provide a minimum of one boring.</p> <p>Additional borings should be provided in areas of erratic subsurface conditions.</p>
Retaining Walls	<p>A minimum of one boring should be performed for each retaining wall. For retaining walls more than 30 m in length, the spacing between borings should be no greater than 60 m. Additional borings inboard and outboard of the wall line to define conditions at the toe of the wall and in the zone behind the wall to estimate lateral loads and anchorage capacities should be considered.</p>
Roadways	<p>The spacing of borings along the roadway alignment generally should not exceed 60 m. The spacing and location of the borings should be selected considering the geologic complexity and soil/rock strata continuity within the project area, with the objective of defining the vertical and horizontal boundaries of distinct soil and rock units within the project limits.</p>
Cuts	<p>A minimum of one boring should be performed for each cut slope. For cuts more than 60 m in length, the spacing between borings along the length of the cut should generally be between 60 and 120 m.</p> <p>At critical locations and high cuts, provide a minimum of three borings in the transverse direction to define the existing geological conditions for stability analyses. For an active slide, place at least one boring upslope of the sliding area.</p>
Embankments	<p>Use criteria presented above for Cuts.</p>
Culverts	<p>A minimum of one boring at each major culvert. Additional borings should be provided for long culverts or in areas of erratic subsurface conditions.</p>

\*Also see *FHWA Geotechnical Checklist and Guidelines*; FHWA-ED-88-053

**TABLE 2-4.**

**LIST OF EQUIPMENT FOR FIELD EXPLORATIONS**

Paperwork/Forms	<p>Site Plan          Technical specifications          Field Instructions Sheet(s)          Daily field memorandum forms          Blank boring log forms          Forms for special tests (vane shear, permeability tests, etc.)          Blank sample labels or white tape          Copies of required permits          Field book (moisture proof)          Health and Safety plan          Field Manuals          Subcontractor expense forms</p>
Sampling Equipment	<p>Samplers and blank tubes etc.          Knife (to trim samples)          Folding rule (measured in 1 cm increments)          25 m tape with a flat-bottomed float attached to its end so that it can also be used for water level measurements          Hand level (in some instances, an engineer's level is needed)          Rags          Jars and core boxes          Sample boxes for shipping (if needed)          Buckets (empty) with lid if bulk samples required          Half-round file          Wire brush</p>
Safety/Personal Equipment	<p>Hard hat          Safety boots          Safety glasses (when working with hammer or chisel)          Rubber boots (in some instances)          Rain gear (in some instances)          Work gloves</p>
Miscellaneous Equipment	<p>Clipboard          Pencils, felt markers, grease pencils          Scale and straight edge          Watch          Calculator          Camera          Compass          Wash bottle or test tube          Pocket Penetrometer and/or Torvane          Communication Equipment (two-way radio, cellular phone)</p>



### **2.5.5 Personnel and Personal Behavior**

The field crew is a visible link to the public. The public's perception of the reputation and credibility of the agency represented by the field crew may be determined by the appearance and behavior of the personnel and field equipment. It is the drilling supervisor's duty to maintain a positive image of field exploration activities, including the appearance of equipment and personnel and the respectful behavior of all personnel. In addition, the drilling supervisor is responsible for maintaining the safety of drilling operations and related work, and for the personal safety of all field personnel and the public. The designated Health and Safety Officer is responsible for verifying compliance of all field personnel with established health and safety procedures related to contaminated soils or groundwater. Appendix A presents typical safety guidelines for drilling into soil and rock and health and safety procedures for entry into borings.

The field inspector may occasionally be asked about site activities. The field inspector should always identify the questioner. It is generally appropriate policy not to provide any detailed project-related information, since at that stage the project is normally not finalized, there may still be on going discussions, negotiations, right-of-way acquisitions and even litigation. An innocent statement or a statement based on one's perception of the project details may result in misunderstandings or potentially serious problems. In these situations it is best to refer questions to a designated officer of the agency familiar with all aspects of the project.

### **2.5.6 Plans and Specifications**

Each subsurface investigation program must include a location plan and technical specifications to define and communicate the work to be performed.

The project location plan(s) should include as a minimum: a project location map; general surface features such as existing roadways, streams, structures, and vegetation; north arrow and selected coordinate grid points; ground surface contours at an appropriate elevation interval; and locations of proposed structures and alignment of proposed roadways, including ramps. On these plans, the proposed boring, piezometer, and in-situ test locations should be shown. A table which presents the proposed depths of each boring and sounding, as well as the required depths for piezometer screens should be given.

The technical specifications should clearly describe the work to be performed including the materials, equipment and procedures to be used for drilling and sampling, for performing in situ tests, and for installing piezometers. In addition, it is particularly important that the specifications clearly define the method of measurement and the payment provisions for all work items.

## **2.6 STANDARDS AND GUIDELINES**

Field exploration by borings should be guided by local practice, by applicable FHWA and state DOTs procedures, and by the AASHTO and ASTM standards listed in Table 2-5.

Current copies of these standards and manuals should be maintained in the engineer's office for ready reference. The geotechnical engineer and field inspector should be thoroughly familiar with the contents of these documents, and should consult them whenever unusual subsurface situations arise during the field investigation. The standard procedures should always be followed; improvisation of investigative techniques may result in erroneous or misleading results which may have serious consequences on the interpretation of the field data.

TABLE 2-5.

FREQUENTLY-USED STANDARDS FOR FIELD INVESTIGATIONS

<i>Standard</i>		<i>Title</i>
<i>AASHTO</i>	<i>ASTM</i>	
M 146	C 294	Descriptive Nomenclature for Constituents of Natural Mineral Aggregates
T 86	D 420	Guide for Investigating and Sampling Soil and Rock
-	D 1194	Test Method for Bearing Capacity of Soil for Static Load on Spread Footings
-	D 1195	Test Method for Repetitive Static Plate Load Tests of Soils and Flexible Pavement Components, for Airport and Highway Pavements
-	D 1196	Test Method for Nonrepetitive Static Plate Load Tests of Soils and Flexible Pavement Components, for Use in Evaluation and Design of Airport and Highway Pavements
T 203	D 1452	Practice for Soil Investigation and Sampling by Auger Borings
T 206	D 1586	Standard Penetration Test (SPT) and Split-Barrel Sampling of Soils
T 207	D 1587	Practice for Thin-Walled Tube Sampling of Soils
T 225	D 2113	Practice for Diamond Core Drilling for Site Investigation
M 145	D 2487	Test Method for Classification of Soils for Engineering Purposes
-	D 2488	Practice for Description and Identification of Soils (Visual-Manual Procedure)
T 223	D 2573	Test Method for Field Vane Shear Test (VST) in Cohesive Soil
-	D 3550	Practice for Ring-Lined Barrel Sampling of Soils
-	D 4220	Practice for Preserving and Transporting Soil Samples
-	D 4428	Test Method for Crosshole Seismic Test (CHT)
-	D 4544	Practice for Estimating Peat Deposit Thickness
-	D 4700	General Methods of Augering, Drilling, & Site Investigation
-	D 4719	Test Method for Pressuremeter Testing (PMT) in Soils
-	D 4750	Test Method for Determining Subsurface Liquid Levels in a Borehole or Monitoring Well (Observation Well)
-	D 5079	Practices for Preserving and Transporting Rock Core Samples
-	D 5092	Design and Installation of Ground Water Monitoring Wells in Aquifers
-	D 5777	Guide for Seismic Refraction Method for Subsurface Investigation
-	D 5778	Test Method for Electronic Cone Penetration Testing (CPT) of Soils
-	D 6635	Procedures for Flat Plate Dilatometer Testing (DMT) in Soils
-	G 57	Field Measurement of Soil Resistivity (Wenner Array)

## CHAPTER 3.0

### DRILLING AND SAMPLING OF SOIL AND ROCK

This chapter describes the equipment and procedures commonly used for the drilling and sampling of soil and rock. The methods addressed in this chapter are used to retrieve soil samples and rock cores for visual examination and laboratory testing. Chapter 5 discusses in-situ testing methods which should be included in subsurface investigation programs and performed in conjunction with conventional drilling and sampling operations.

#### 3.1 SOIL EXPLORATION

##### 3.1.1 Soil Drilling

A wide variety of equipment is available for performing borings and obtaining soil samples. The method used to advance the boring should be compatible with the soil and groundwater conditions to assure that soil samples of suitable quality are obtained. Particular care should be exercised to properly remove all slough or loose soil from the boring before sampling. Below the groundwater level, drilling fluids are often needed to stabilize the sidewalls and bottom of the boring in soft clays or cohesionless soils. Without stabilization, the bottom of the boring may heave or the sidewalls may contract, either disturbing the soil prior to sampling or preventing the sampler from reaching the bottom of the boring. In most geotechnical explorations, borings are usually advanced with solid stem continuous flight, hollow-stem augers, or rotary wash boring methods.

##### **Solid Stem Continuous Flight Augers**

Solid stem continuous flight auger drilling is generally limited to stiff cohesive soils where the boring walls are stable for the entire depth of the boring. Figure 3-1a shows continuous flight augers being used with a drill rig. A drill bit is attached to the leading section of flight to cut the soil. The flights act as a screw conveyor, bringing cuttings to the top of the hole. As the auger drills into the earth, additional auger sections are added until the required depth is reached.

Due to their limited application, continuous flight augers are generally not suitable for use in investigations requiring soil sampling. When used, careful observation of the resistance to penetration and the vibrations or "chatter" of the drilling bit can provide valuable data for interpretation of the subsurface conditions. Clay, or "fishtail", drill bits are commonly used in stiff clay formations (Figure 3-1b). Carbide-tipped "finger" bits are commonly used where hard clay formations or interbedded rock or cemented layers are encountered. Since finger bits commonly leave a much larger amount of loose soil, called slough, at the bottom of the hole, they should only be used when necessary. Solid stem drill rods are available in many sizes ranging in outside diameter from 102 mm (4.0 in) to 305 mm (12.0 in) (Figure 3-1c), with the 102 mm (4.0 in) diameter being the most common. The lead assembly in which the drill bit is connected to the lead auger flight using cotter pins is shown in Figure 3-1d. It is often desirable to twist the continuous-flight augers into the ground with rapid advancement and to withdraw the augers without rotation, often termed "dead-stick withdrawal", to maintain the cuttings on the auger flights with minimum mixing. This drilling method aids visual identification of changes in the soil formations. In all instances, the cuttings and the reaction of the drilling equipment should be regularly monitored to identify stratification changes between sample locations.



(a)



(b)



(c)



(d)

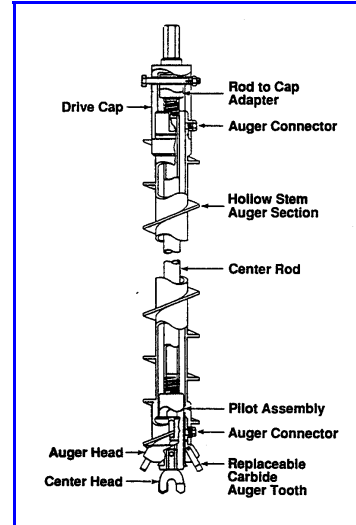
**Figure 3-1. Solid Stem Continuous Flight Auger Drilling System:** (a) In use on drill rig, (b) Finger and fishtail bits, (c) Sizes of solid stem auger flights, (d) Different assemblies of bits and auger flights. (All pictures in the above format are courtesy of DeJong and Boulanger, 2000)

### Hollow Stem Continuous Flight Augers

In general hollow stem augers are very similar to the continuous flight auger except, as the name suggests, it has a large hollow center. This is visually evident in Figure 3-3a, where a solid stem flight and a hollow stem flight are pictured side-by-side. The various components of the hollow stem auger system are shown schematically in Figure 3-2 and pictured in Figure 3-3b to 3-3f. Table 3-1 presents dimensions of hollow-stem augers available on the market, some of which are pictured in Figure 3-3c. When the hole is being advanced, a center stem and plug are inserted into the hollow center of the auger. The center plug with a drag bit attached and located in the face of the cutter head aids in the advancement of the hole and also prevents soil cuttings from entering the hollow-stem auger. The center stem consists of rods that connect at the bottom of the plug or bit insert and at the top to a drive adapter to ensure that the center stem and bit rotate with the augers. Some drillers prefer to advance the boring without the center plug, allowing a natural "plug" of compacted cuttings to form. This practice should not be used since the extent of this plug is difficult to control and determine.

Once the augers have advanced the hole to the desired sample depth, the stem and plug are removed. A sampler may then be lowered through the hollow stem to sample the soil at the bottom of the hole. If the augers have been seated into rock, then a standard core barrel can be used.

Hollow-stem augering methods are commonly used in clay soils or in granular soils above the groundwater level, where the boring walls may be unstable. The augers form a temporary casing to allow sampling of the "undisturbed soil" below the bit. The cuttings produced from this drilling method are mixed as they move up the auger flights and therefore are of limited use for visual observation purposes. At greater depths there may be considerable differences between the soil being augered at the bottom of the boring and the cuttings appearing at the ground surface. The field supervisor must be aware of these limitations in identification of soil conditions between sample locations.



**Figure 3-2. Hollow Stem Auger Components (ASTM D 4700).**

Significant problems can occur where hollow-stem augers are used to sample soils below the groundwater level. The hydrostatic water pressure acting against the soil at the bottom of the boring can significantly disturb the soil, particularly in granular soils or soft clays. Often the soils will heave and plug the auger, preventing the sampler from reaching the bottom of the boring. Where heave or disturbance occurs, the penetration resistance to the driven sampler can be significantly reduced. When this condition exists, it is advisable to halt the use of hollow-stem augers at the groundwater level and to convert to rotary wash boring methods. Alternatively the hollow-stem auger can be flooded with water or drilling fluid to balance the head; however, this approach is less desirable due to difficulties in maintaining an adequate head of water.

**TABLE 3-1.**

**DIMENSIONS OF COMMON HOLLOW-STEM AUGERS**

Inside Diameter of Hollow Stem mm (in)	Outside Diameter of Flighting mm (in)	Cutting Diameter of Auger Head mm (in)
57 (2.250)	143 (5.625)	159 (6.250)
70 (2.750)	156 (6.125)	171 (6.750)
83 (3.250)	168 (6.625)	184 (7.250)
95 (3.750)	181 (7.125)	197 (7.750)
108 (4.250)	194 (7.625)	210 (8.250)
159 (6.250)	244 (9.625)	260 (10.250)
184 (7.250)	295 (11.250)	318 (12.000)
210 (8.250)	311 (12.250)	330 (13.000)
260 (10.250)	356 (14.000)	375 (14.750)
311 (12.250)	446 (17.500)	470 (18.500)

Note: Adapted after Central Mine Equipment Company. For updates, see: <http://www.cmeco.com/>



(a)



(b)



(c)



(d)



(e)



(f)

**Figure 3-3. Hollow Stem Continuous Flight Auger Drilling Systems: (a) Comparison with solid stem auger; (b) Typical drilling configuration; (c) Sizes of hollow stem auger flights; (d) Stepwise center bit; (e) Outer bits; (f) Outer and inner assembly.**

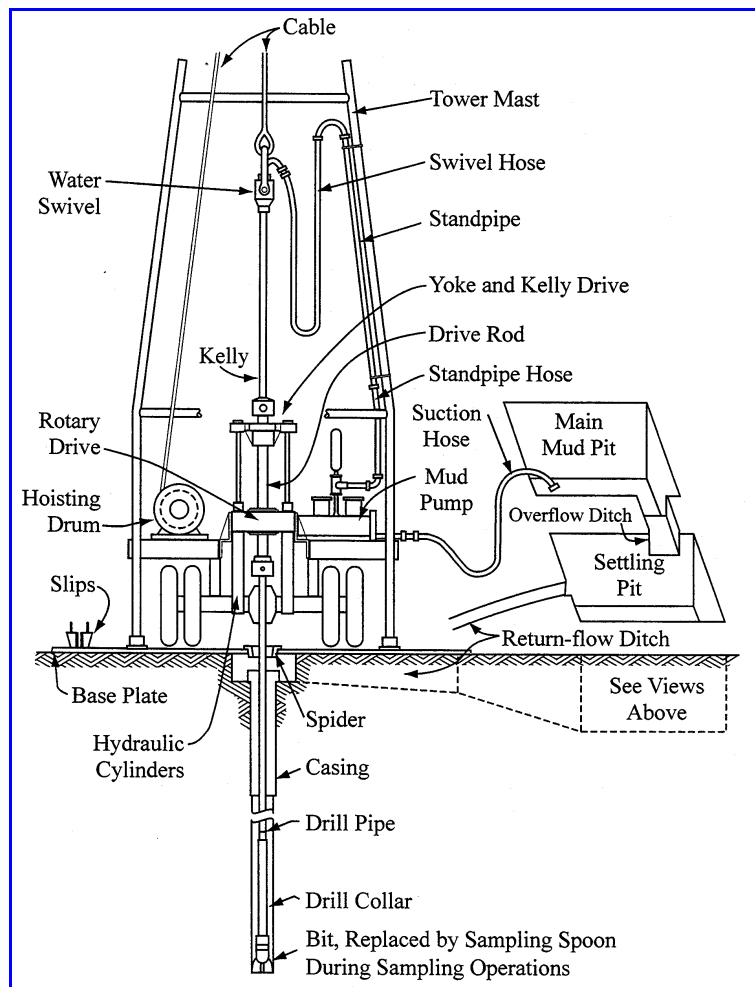
### Rotary Wash Borings

The rotary wash boring method (Figures 3-4 and 3-5) is generally the most appropriate method for use in soil formations below the groundwater level. In rotary wash borings, the sides of the borehole are supported either with casing or with the use of a drilling fluid. Where drill casing is used, the boring is advanced sequentially by: (a) driving the casing to the desired sample depth, (b) cleaning out the hole to the bottom of the casing, and (c) inserting the sampling device and obtaining the sample from below the bottom of the casing.

The casing (Figure 3-5b) is usually selected based on the outside diameter of the sampling or coring tools to be advanced through the casing, but may also be influenced by other factors such as stiffness considerations for borings in water bodies or very soft soils, or dimensions of the casing couplings. Casing for rotary wash borings is typically furnished with inside diameters ranging from 60 mm (2.374 in) to 130 mm (5.125 in). Even with the use of casing, care must be taken when drilling below the groundwater table to maintain a head of water within the casing above the groundwater level. Particular attention must be given to adding water to the hole as the drill rods are removed after cleaning out the hole prior to sampling. Failure to maintain an adequate head of water may result in loosening or heaving (blow-up) of the soil to be sampled beneath the casing. Tables 3-2 and 3-3 present data on available drill rods and casings, respectively.

For holes drilled using drilling fluids to stabilize the borehole walls, casing should still be used at the top of the hole to protect against sloughing of the ground due to surface activity, and to facilitate circulation of the drilling fluid. In addition to stabilizing the borehole walls, the drilling fluid (water, bentonite, foam, Revert or other synthetic drilling products) also removes the drill cuttings from the boring. In granular soils and soft cohesive soils, bentonite or polymer additives are typically used to increase the weight of the drill fluid and thereby minimize stress reduction in the soil at the bottom of the boring. For borings advanced with the use of drilling fluids, it is important to maintain the level of the drilling fluid at or above the ground surface to maintain a positive pressure for the full depth of the boring.

Two types of bits are often used with the rotary wash method (Figure 3-5c). Drag bits are commonly used in clays and loose sands, whereas roller bits are used to penetrate dense coarse-grained granular soils, cemented zones, and soft or weathered rock.



**Figure 3-4. Schematic of Drilling Rig for Rotary Wash Methods** (After Hvorslev, 1948).

Examination of the cuttings suspended in the wash fluid provides an opportunity to identify changes in the soil conditions between sample locations (Figure 3-6d). A strainer is held in the drill fluid discharge stream to catch the suspended material (Figure 3-6e,f). In some instances (especially with uncased holes) the drill fluid return is reduced or lost. This is indicative of open joints, fissures, cavities, gravel layers, highly permeable zones and other stratigraphic conditions that may cause a sudden loss in pore fluid and must be noted on the logs.

The properties of the drilling fluid and the quantity of water pumped through the bit will determine the size of particles that can be removed from the boring with the circulating fluid. In formations containing gravel, cobbles, or larger particles, coarse material may be left in the bottom of the boring. In these instances, clearing the bottom of the boring with a larger-diameter sampler (such as a 76 mm (3.0 in) OD split-barrel sampler) may be needed to obtain a representative sample of the formation.

**TABLE 3-2.**

**DIMENSIONS OF COMMON DRILL RODS**

Size	Outside Diameter of Rod mm (in)	Inside Diameter of Rod mm (in)	Inside Diameter of Coupling mm (in)
RW	27.8 (1.095)	18.3 (0.720)	10.3 (0.405)
EW	34.9 (1.375)	22.2 (0.875)	12.7 (0.500)
AW	44.4 (1.750)	31.0 (1.250)	15.9 (0.625)
BW	54.0 (2.125)	44.5 (1.750)	19.0 (0.750)
NW	66.7 (2.625)	57.2 (2.250)	34.9 (1.375)

Note 1: “W” and “X” type rods are the most common types of drill rod and require a separate coupling to connect rods in series. Other types of rods have been developed for wireline sampling (“WL”) and other specific applications.

Note 2: Adapted after Boart Longyear Company and Christensen Dia-Min Tools, Inc. For updates, see: <http://www.boartlongyear.com/>

**TABLE 3-3.**

**DIMENSIONS OF COMMON FLUSH-JOINT CASINGS**

Size	Outside Diameter of Casing mm (in)	Inside Diameter of Casing mm (in)
RW	36.5 (1.437)	30.1 (1.185)
EW	46.0 (1.811)	38.1 (1.500)
AW	57.1 (2.250)	48.4 (1.906)
BW	73.0 (2.875)	60.3 (2.375)
NW	88.9 (3.500)	76.2 (3.000)

Note 1: Coupling system is incorporated into casing and are flush, internally and externally.

Note 2: Adapted after Boart Longyear Company and Christensen Dia-Min Tools, Inc. For updates, see: <http://www.boartlongyear.com/>





(a)



(b)



(c)



(d)



(e)



(f)

**Figure 3-5. Rotary Wash Drilling System: (a) Typical drilling configuration; (b) Casing and driving shoe; (c) Diamond, drag, and roller bits; (d) Drill fluid discharge; (e) Fluid cuttings catch screen; (f) Settling basin (mud tank).**

## Bucket Auger Borings

Bucket auger drills are used where it is desirable to remove and/or obtain large volumes of disturbed soil samples, such as for projects where slope stability is an issue. Occasionally, bucket auger borings can be used to make observations of the subsurface by personnel. However this practice is not recommended due to safety concerns. Video logging provides an effective method for downhole observation.

A common bucket auger drilling configuration is shown in Figure 3-6. Bucket auger borings are usually drilled with a 600 mm (24 in) to 1200 mm (48 in) diameter bucket. The bucket length is generally 600 mm (24 in) to 900 mm (36 in) and is basically an open-top metal cylinder having one or more slots cut in its base to permit the entrance of soil and rock as the bucket is rotated. At the slots, the metal of the base is reinforced and teeth or sharpened cutting edges are provided to break up the material being sampled.

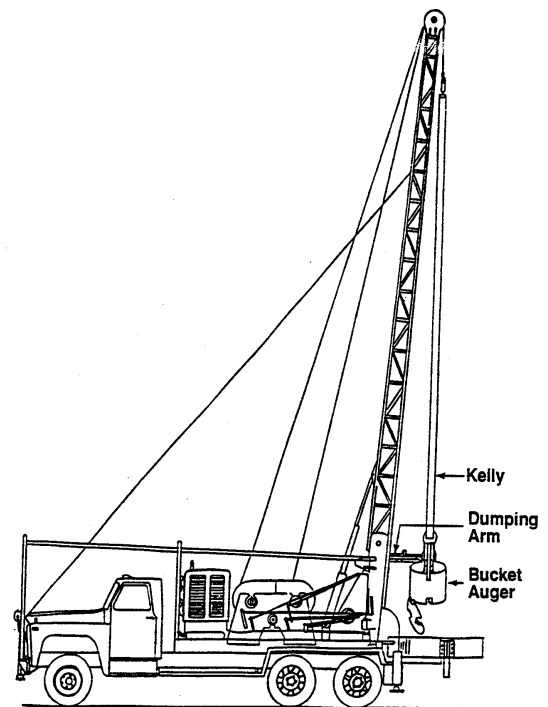
The boring is advanced by a rotating drilling bucket with cutting teeth mounted to the bottom. The drilling bucket is attached to the bottom of a "kelly bar", which typically consists of two to four square steel tubes assembled one inside another enabling the kelly bar to telescope to the bottom of the hole. At completion of each advancement, the bucket is retrieved from the boring and emptied on the ground near the drill rig.

Bucket auger borings are typically advanced by a truck-mounted drill. Small skid-mounted and A-frame drill rigs are available for special uses, such as drilling on steep hillsides or under low clearance (less than 2.5 m (8 ft)). Depending on the size of the rig and subsurface conditions, bucket augers are typically used to drill to depths of about 30 m (100 ft) or less, although large rigs with capabilities to drill to depths of 60 m (200 ft) or greater are available.

The bucket auger is appropriate for most soil types and for soft to firm bedrock. Drilling below the water table can be completed where materials are firm and not prone to large-scale sloughing or water infiltration. For these cases the boring can be advanced by filling it with fluid (water or drilling mud), which provides a positive head and reduces the tendency for wall instability. Manual down-hole inspection and logging should not be performed unless the hole is cased. Only trained personnel should enter a bucket auger boring strict safety procedures established by the appropriate regulatory agencies (e.g. ADSC 1995). Inspection and downhole logging can more safely be accomplished using video techniques.

The bucket auger method is particularly useful for drilling in materials containing gravel and cobbles because the drilling bucket can auger through cobbles that may cause refusal for conventional drilling equipment. Also, since drilling is advanced in 300 mm (12 in) to 600 mm (24 in) increments and is emptied after each of these advances, the bucket augering boring method is advantageous where large-volume samples from specific subsurface locations are required, such as for aggregate studies.

In hard materials (concretions or rocks larger than can enter the bucket), special-purpose buckets and attachments can be substituted for the standard "digging bucket". Examples of



**Figure 3-6. Setup of Bucket Auger & Rig**  
(from ASTM D 4700)

special attachments include coring buckets with carbide cutting teeth mounted along the bottom edge, rock buckets that have heavy-duty digging teeth and wider openings to collect broken materials, single-shank breaking bars that are attached to the Kelly bar and dropped to break up hard rock, and clam shells that are used to pick up cobbles and large rock fragments from the bottom of borings.

### **Area Specific Methods**

Drilling contractors in different parts of the country occasionally develop their own subsurface exploration methods which may differ significantly from the standard methods or may be a modification of standard methods. These methods are typically developed to meet the requirements of local site conditions. For example, a hammer drill manufactured by Becker Drilling Ltd. of Canada (Becker Hammer) is used to penetrate gravel, dense sand and boulders.

### **Hand Auger Borings**

Hand augers are often used to obtain shallow subsurface information from sites with difficult access or terrain where vehicle accessibility is not possible. Several types of hand augers are available with the standard post hole type barrel auger as the most common. In stable cohesive soils, hand augers can be advanced up to 8 m (25 ft). Clearly maintaining an open hole in granular soils may be difficult and cobbles & boulders will create significant problems. Hand held power augers may be used, but are obviously more difficult to carry into remote areas. Cuttings contained in the barrel can be logged and tube samples can be advanced at any depth. Although Shelby tube samples can be taken, small 25- to 50- mm (1.0- to 2.0- inch) diameter tubes are often used to facilitate handling. Other hand auger sampling methods are reviewed in ASTM D 4700.

### **Exploration Pit Excavation**

Exploration pits and trenches permit detailed examination of the soil and rock conditions at shallow depths and relatively low cost. Exploration pits can be an important part of geotechnical explorations where significant variations in soil conditions occur (vertically and horizontally), large soil and/or non-soil materials exist (boulders, cobbles, debris) that cannot be sampled with conventional methods, or buried features must be identified and/or measured.

Exploration pits are generally excavated with mechanical equipment (backhoe, bulldozer) rather than by hand excavation. The depth of the exploration pit is determined by the exploration requirements, but is typically about 2 m (6.5 ft) to 3 m (10 ft). In areas with high groundwater level, the depth of the pit may be limited by the water table. Exploration pit excavations are generally unsafe and/or uneconomical at depths greater than about 5 m (16 ft) depending on the soil conditions.

During excavation, the bottom of the pit should be kept relatively level so that each lift represents a uniform horizon of the deposit. At the surface, the excavated material should be placed in an orderly manner adjoining the pit with separate stacks to identify the depth of the material. The sides of the pit should be cleaned by chipping continuously in vertical bands, or by other appropriate methods, so as to expose a clean face of rock or soil.

Survey control at exploration pits should be done using optical survey methods to accurately determine the ground surface elevation and plan locations of the exploration pit. Measurements should be taken and recorded documenting the orientation, plan dimensions and depth of the pit, and the depths and the thickness of each stratum exposed in the pit.

Exploration pits can, generally, be backfilled with the spoils generated during the excavation. The backfilled material should be compacted to avoid excessive settlements. Tampers or rolling equipment may be used to facilitate compaction of the backfill.

The U.S. Department of Labor's Construction Safety and Health Regulations, as well as regulations of any other governing agency must be reviewed and followed prior to excavation of the exploration pit, particularly in regard to shoring requirements.

### Logging Procedures

The appropriate scale to be used in logging the exploration pit will depend on the complexity of geologic structures revealed in the pit and the size of the pit. The normal scale for detailed logging is 1:20 or 1:10, with no vertical exaggeration.

In logging the exploration pit a vertical profile should be made parallel with one pit wall. The contacts between geologic units should be identified and drawn on the profile, and the units sampled (if considered appropriate by the geotechnical engineer). Characteristics and types of soil or lithologic contacts should be noted. Variations within the geologic units must be described and indicated on the pit log wherever the variations occur. Sample locations should be shown in the exploration pit log and their locations written on a sample tag showing the station location and elevation. Groundwater should also be noted on the exploration pit log.

### Photography and Video Logging

After the pit is logged, the shoring will be removed and the pit may be photographed or video logged at the discretion of the geotechnical engineer. Photographs and/or video logs should be located with reference to project stationing and baseline elevation. A visual scale should be included in each photo and video.

### **3.1.2 Soil Samples**

Soil samples obtained for engineering testing and analysis, in general, are of two main categories:

- C Disturbed (but representative)
- C Undisturbed

#### **Disturbed Samples**

Disturbed samples are those obtained using equipment that destroy the macro structure of the soil but do not alter its mineralogical composition. Specimens from these samples can be used for determining the general lithology of soil deposits, for identification of soil components and general classification purposes, for determining grain size, Atterberg limits, and compaction characteristics of soils. Disturbed samples can be obtained with a number of different methods as summarized in Table 3-4.

#### **Undisturbed Samples**

Undisturbed samples are obtained in clay soil strata for use in laboratory testing to determine the engineering properties of those soils. Undisturbed samples of granular soils can be obtained, but often specialized procedures are required such as freezing or resin impregnation and block or core type sampling. It should be

noted that the term “undisturbed” soil sample refers to the relative degree of disturbance to the soil’s in-situ properties. Undisturbed samples are obtained with specialized equipment designed to minimize the disturbance to the in-situ structure and moisture content of the soils. Specimens obtained by undisturbed sampling methods are used to determine the strength, stratification, permeability, density, consolidation, dynamic properties, and other engineering characteristics of soils. Common methods for obtaining undisturbed samples are summarized in Table 3-4.

### 3.1.3 Soil Samplers

A wide variety of samplers are available to obtain soil samples for geotechnical engineering projects. These include standard sampling tools which are widely used as well as specialized types which may be unique to certain regions of the country to accommodate local conditions and preferences. The following discussions are general guidelines to assist geotechnical engineers and field supervisors select appropriate samplers, but in many instances local practice will control. Following is a discussion of the more commonly used types of samplers.

**TABLE 3-4.**

#### COMMON SAMPLING METHODS

<i>Sampler</i>	<i>Disturbed / Undisturbed</i>	<i>Appropriate Soil Types</i>	<i>Method of Penetration</i>	<i>% Use in Practice</i>
<b>Split-Barrel (Split Spoon)</b>	Disturbed	Sands, silts, clays	Hammer driven	85
<b>Thin-Walled Shelby Tube</b>	Undisturbed	Clays, silts, fine-grained soils, clayey sands	Mechanically Pushed	6
<b>Continuous Push</b>	Partially Undisturbed	Sands, silts, & clays	Hydraulic push with plastic lining	4
<b>Piston</b>	Undisturbed	Silts and clays	Hydraulic Push	1
<b>Pitcher</b>	Undisturbed	Stiff to hard clay, silt, sand, partially weather rock, and frozen or resin impregnated granular soil	Rotation and hydraulic pressure	<1
<b>Denison</b>	Undisturbed	Stiff to hard clay, silt, sand and partially weather rock	Rotation and hydraulic pressure	<1
<b>Modified California</b>	Disturbed	Sands, silts, clays, and gravels	Hammer driven (large split spoon)	<1
<b>Continuous Auger</b>	Disturbed	Cohesive soils	Drilling w/ Hollow Stem Augers	<1
<b>Bulk</b>	Disturbed	Gravels, Sands, Silts, Clays	Hand tools, bucket augering	<1
<b>Block</b>	Undisturbed	Cohesive soils and frozen or resin impregnated granular soil	Hand tools	<1

#### Split Barrel Sampler

The split-barrel (or split spoon) sampler is used to obtain disturbed samples in all types of soils. The split spoon sampler is typically used in conjunction with the *Standard Penetration Test* (SPT), as specified in AASHTO T206 and ASTM D1586, in which the sampler is driven with a 63.5-kg (140-lb) hammer dropping from a height of 760 mm (30 in). Details of the Standard Penetration Test are discussed in Section 5.1.

In general, the split-barrel samplers are available in standard lengths of 457 mm (18 in) and 610 mm (24 in) with inside diameters ranging from 38.1 mm (1.5 in) to 114.3 mm (4.5 in) in 12.7 mm (0.5 in) increments (Figure 3-7a,b). The 38.1 mm (1.5 in) inside diameter sampler is popular because correlations have been developed between the number of blows required for penetration and a few select soil properties. The larger-diameter samplers (inside diameter larger than 51 mm (2 in) are sometimes used when gravel particles are present or when more material is needed for classification tests.

The 38.1 mm (1.5 in) inside diameter standard split-barrel sampler has an outside diameter of 51 mm (2.0 in) and a cutting shoe with an inside diameter of 34.9 mm (1.375 in). This corresponds to a relatively thick-walled sampler with an area ratio  $[A_r = 100 * (D_{\text{external}}^2 - D_{\text{internal}}^2) / D_{\text{internal}}^2]$  of 112 percent (Hvorslev, 1949). This high area ratio disturbs the natural characteristics of the soil being sampled, thus disturbed samples are obtained.

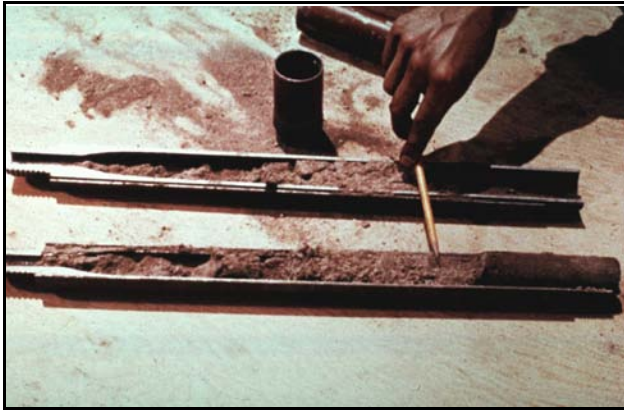
A ball check valve incorporated in the sampler head facilitates the recovery of cohesionless materials. This valve seats when the sampler is being withdrawn from the borehole, thereby preventing water pressure on the top of the sample from pushing it out. If the sample tends to slide out because of its weight, vacuum will develop at the top of the sample to retain it.

As shown in Figure 3-8a, when the shoe and the sleeve of this type of sampler are unscrewed from the split barrel, the two halves of the barrel may be separated and the sample may be extracted easily. The soil sample is removed from the split-barrel sampler it is either placed and sealed in a glass jar, sealed in a plastic bag, or sealed in a brass liner (Figure 3-8b). Separate containers should be used if the sample contains different soil types. Alternatively, liners may be placed inside the sampler with the same inside diameter as the cutting shoe (Figure 3-9a). This allows samples to remain intact during transport to the laboratory. In both cases, samples obtained with split barrels are disturbed and therefore are only suitable for soil identification and general classification tests.

Steel or plastic sample retainers are often required to keep samples of clean granular soils in the split-barrel sampler. Figure 3-9b shows a basket shoe retainer, a spring retainer and a trap valve retainer. They are inserted inside the sampler between the shoe and the sample barrel to help retain loose or flowing materials. These retainers permit the soil to enter the sampler during driving but upon withdrawal they close and thereby retain the sample. Use of sample retainers should be noted on the boring log.



**Figure 3-7. Split-Barrel Samplers: (a) Lengths of 457 mm (18 in) and 610 mm (24 in); (b) Inside diameters from 38.1 mm (1.5 in) to 89 mm (3.5 in).**



(a)



(b)

**Figure 3-8. Split Barrel Sampler: (a) Open sampler with soil sample and cutting shoe; (b) Sample jar, split-spoon, shelly tube, and storage box for transport of jar samples.**



(a)



(b)

**Figure 3-9. Split Barrel Sampler. (a) Stainless steel and brass retainers (b) Sample catchers.**

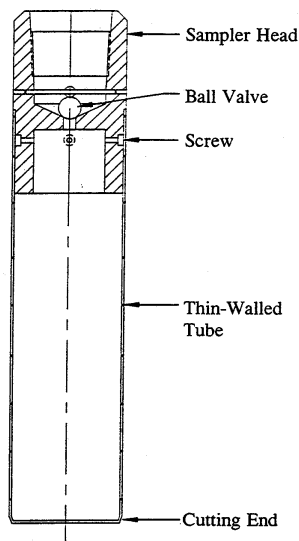
In U.S. practice, it is normal to omit the inside liner in the split-spoon barrel. The resistance of the sampler to driving is altered depending upon whether or not a liner is used (Skempton, 1986; Kulhawy & Mayne, 1990). Therefore, in the case that a liner is used, then the boring logs used be clearly noted to reflect this variation from standard U.S. procedures, as the reported numbers in driving may affect the engineering analysis.

## Thin Wall Sampler

The thin-wall tube (Shelby) sampler is commonly used to obtain relatively undisturbed samples of cohesive soils for strength and consolidation testing. The sampler commonly used (Figures 3-10) has a 76 mm (3.071 in) outside diameter and a 73 mm (2.875 in) inside diameter, resulting in an area ratio of 9 percent. Thin wall samplers vary in outside diameter between 51 mm (2.0 in) and 76 mm (3.0 in) and typically come in lengths from 700 mm (27.56 in) to 900 mm (35.43 in), as shown in Figure 3-11. Larger diameter sampler tubes are used where higher quality samples are required and sampling disturbance must be reduced. The test method for thin-walled tube sampling is described in AASHTO T 207 and ASTM D 1587.

The thin-walled tubes are manufactured using carbon steel, galvanized-coated carbon steel, stainless steel, and brass. The carbon steel tubes are often the lowest cost tubes but are unsuitable if the samples are to be stored in the tubes for more than a few days or if the inside of the tubes become rusty, significantly increasing the friction between the tube and the soil sample. In stiff soils, galvanized carbon steel tubes are preferred since carbon steel is stronger, less expensive, and galvanizing provides additional resistance to corrosion. For offshore bridge borings, salt-water conditions, or long storage times, stainless steel tubes are preferred. The thin-walled tube is manufactured with a beveled front edge for cutting a reduced-diameter sample [commonly 72 mm (2.835 in) inside diameter] to reduce friction. The thin-wall tubes can be pushed with a fixed head or piston head, as described later.

The thin-wall tube sampler should not be pushed more than the total length up to the connecting cap less 75 mm (3 in). The remaining 75 mm (3 in) of tube length is provided to accommodate the slough that accumulates to a greater or lesser extent at the bottom of the boring. The sample length is approximately 600 mm (24 in). Where low density soils or collapsible materials are being sampled, a reduced push of 300 mm (12 in) to 450 mm (18 in) may be appropriate to prevent the disturbance of the sample. The thin-walled tube sampler should be pushed slowly with a single, continuous motion using the drill rig's hydraulic system. The hydraulic pressure required to advance the thin-walled tube sampler should be noted and recorded on the log. The sampler head contains a check valve that allows water to pass through the sampling head into the drill rods. This check valve must be clear of mud and sand and should be checked prior to each sampling attempt. After the push is completed, the driller should wait at least ten minutes to allow the sample to swell slightly within the tube, then rotate the drill rod string through two complete revolutions to shear off the sample, and then slowly and carefully bring the sample to the surface. In stiff soils it is often unnecessary to rotate the sampler.



**Figure 3-10. Schematic of Thin-Walled Shelby Tube**  
(After ASTM D 4700).



**Figure 3-11. Selected Sizes and Types of Thin-Walled Shelby Tubes.**



After taking a thin-walled tube sample, slough or cuttings from the upper end of the tube should be removed using a cleanout tool. The length of sample recovered should be measured and the soil classified for the log. About 25-mm of material at the bottom end of the tube should be removed and the cuttings placed in a properly labeled storage jar. Both ends of the tube should then be sealed with at least a 25 mm (1 in) thick layer of microcrystalline (nonshrinking) wax after placing a plastic disk to protect the ends of the sample (Figure 3-12a). The remaining void above the top of the sample should be filled with moist sand. Plastic end caps should then be placed over both ends of the tube and electrician's tape placed over the joint between the collar of the cap and the tube and over the screw holes. The capped ends of the tubes are then dipped in molten wax. Alternatively, O-ring packers can be inserted into the sample ends and then sealed (Figure 3-12b). This may be preferable as it is cleaner and more rapid. In both cases, the sample must be sealed to ensure proper preservation of the sample. Samples must be stored upright in a protected environment to prevent freezing, desiccation, and alteration of the moisture content (ASTM D 4220).

In some areas of the country, the thin-walled tube samples are field extruded, rather than transported to the laboratory in the tube. This practice is not recommended due to the uncontrolled conditions typical of field operations, and must not be used if the driller does not have established procedures and equipment for preservation and transportation of the extruded samples. Rather, the tube sample should be transported following ASTM D 4220 guidelines to the laboratory and then carefully extruded following a standardized procedure.

The following information should be written on the top half of the tube and on the top end cap: project number, boring number, sample number, and depth interval. The field supervisor should also write on the tube the project name and the date the sample was taken. Near the upper end of the tube, the word "top" and an arrow pointing toward the top of the sample should be included. Putting sample information on both the tube and the end cap facilitates retrieval of tubes from laboratory storage and helps prevent mix-ups in the laboratory when several tubes may have their end caps removed at the same time.

### **Piston Sampler**

The piston sampler (Figure 3-13) is basically a thin-wall tube sampler with a piston, rod, and a modified sampler head. This sampler, also known as an Osterberg or Hvorslev sampler, is particularly useful for sampling soft soils where sample recovery is often difficult although it can also be used in stiff soils.



(a)



(b)

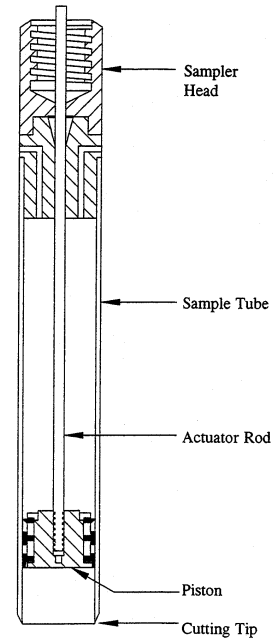
**Figure 3-12. Shelby Tube Sealing Methods. (a) Microcrystalline wax (b) O-ring packer.**

The sampler, with its piston located at the base of the sampling tube, is lowered into the borehole. When the sampler reaches the bottom of the hole, the piston rod is held fixed relative to the ground surface and the thin-wall tube is pushed into the soil slowly by hydraulic pressure or mechanical jacking. The sampler is never driven. Upon completion of sampling, the sampler is removed from the borehole and the vacuum between the piston and the top of the sample is broken. The piston head and the piston are then removed from the tube and jar samples are taken from the top and bottom of the sample for identification purposes. The tube is then labeled and sealed in the same way as a Shelby tube described in the previous section.

The quality of the samples obtained is excellent and the probability of obtaining a satisfactory sample is high. One of the major advantages is that the fixed piston helps prevent the entrance of excess soil at the beginning of sampling, thereby precluding recovery ratios greater than 100 percent. It also helps the soil enter the sampler at a constant rate throughout the sampling push. Thus, the opportunity for 100 percent recovery is increased. The head used on this sampler also acts creates a better vacuum which helps retain the sample better than the ball valve in thin-walled tube (Shelby) samplers.



(a)



(b)

**Figure 3-13. Piston Sampler: (a) Picture with thin-walled tube cut-out to show piston; (b) Schematic (After ASTM D 4700).**

### Pitcher Tube Sampler

The pitcher tube sampler is used in stiff to hard clays and soft rocks, and is well adapted to sampling deposits consisting of alternately hard and soft layers. This sampler is pictured in Figure 3-14 and the primary components shown in Figure 3-15a. These include an outer rotating core barrel with a bit and an inner stationary, spring-loaded, thin-wall sampling tube that leads or trails the outer barrel drilling bit, depending on the hardness of the material being penetrated.

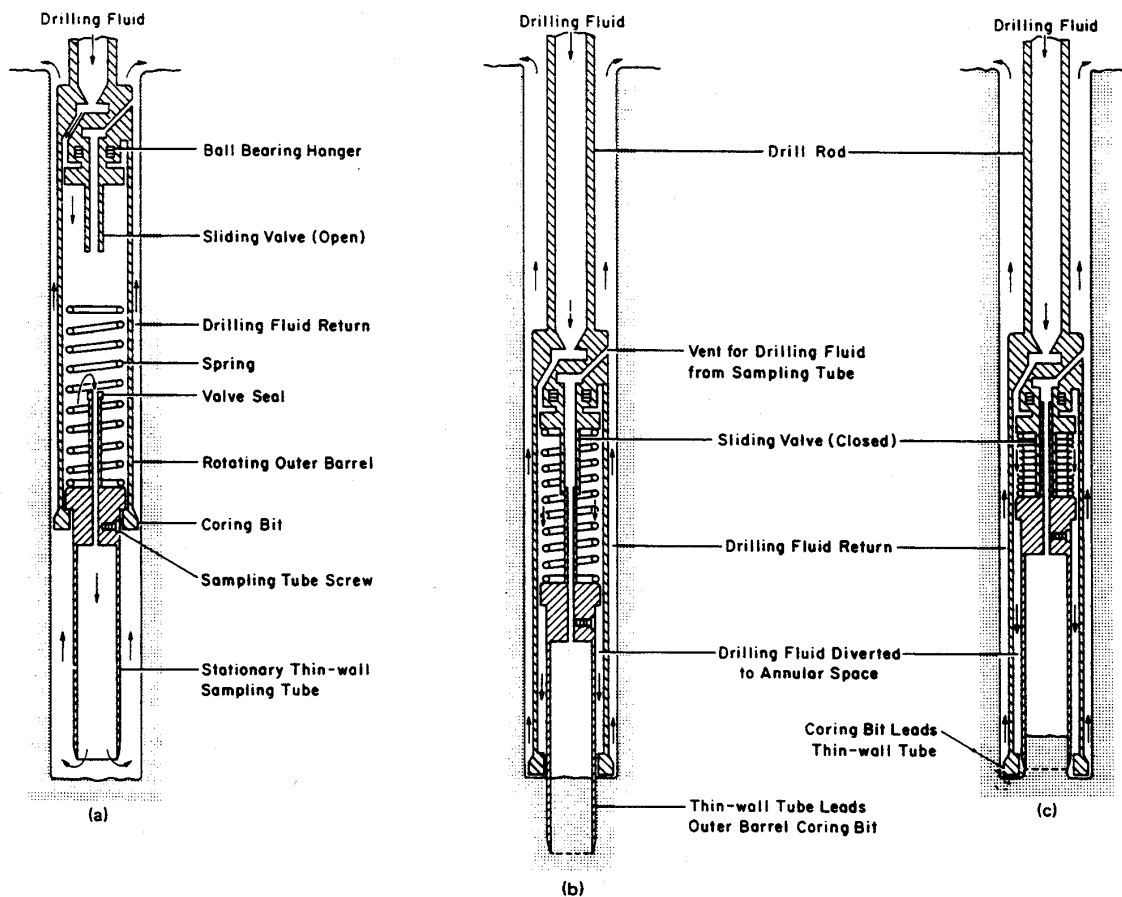


**Figure 3-14. Pitcher Tube Sampler.**

When the drill hole has been cleaned, the sampler is lowered to the bottom of the hole (Figure 3-15a). When the sampler reaches the bottom of the hole, the inner tube meets resistance first and the outer barrel slides past the tube until the spring at the top of the tube contacts the top of the outer barrel. At the same time, the sliding valve closes so that the drilling fluid is forced to flow downward in the annular space between the tube and the outer core barrel and then upward between the sampler and the wall of the hole. If the soil to be penetrated is soft, the spring will compress slightly (Figure 3-15b) and the cutting edge of the tube will be forced into the soil as downward pressure is applied. This causes the cutting edge to lead

the bit of the outer core barrel. If the material is hard, the spring compresses a greater amount and the outer barrel passes the tube so that the bit leads the cutting edge of the tube (Figure 3-15c). The amount by which the tube or barrel leads is controlled by the hardness of the material being penetrated. The tube may lead the barrel by as much as 150 mm (6 in) and the barrel may lead the tube by as much as 12 mm (0.5 in).

Sampling is accomplished by rotating the outer barrel at 100 to 200 revolutions per minute (rpm) while exerting downward pressure. In soft materials sampling is essentially the same as with a thin-wall sampler and the bit serves merely to remove the material from around the tube. In hard materials the outer barrel cuts a core, which is shaved to the inside diameter of the sample tube by the cutting edge and enters the tube as the sampler penetrates. In either case, the tube protects the sample from the erosive action of the drilling fluid at the base of the sampler. The filled sampling tube is then removed from the sampler and is marked, preserved, and transported in the same manner described above for thin-walled tubes.



**Figure 3-15. Pitcher Sampler. (a) Sampler Being Lowered into Drill Hole; (b) Sampler During Sampling of Soft Soils; (c) Sampler During Sampling of Stiff or Dense Soils (Courtesy of Mobile Drilling, Inc.).**

## Denison Sampler

A Denison sampler is similar to a pitcher sampler except that the projection of the sampler tube ahead of the outer rotating barrel is manually adjusted before commencement of sampling operations, rather than spring-controlled during sampler penetration. The basic components of the sampler (Figure 3-16) are an outer rotating core barrel with a bit, an inner stationary sample barrel with a cutting shoe, inner and outer barrel heads, an inner barrel liner, and an optional basket-type core retainer. The coring bit may either be a carbide insert bit or a hardened steel sawtooth bit. The shoe of the inner barrel has a sharp cutting edge. The cutting edge may be made to lead the bit by 12 mm (0.5 in) to 75 mm (3 in) through the use of coring bits of different lengths. The longest lead is used in soft and loose soils because the shoe can easily penetrate these materials and the longer penetration is required to provide the soil core with maximum protection against erosion by the drilling fluid used in the coring. The minimum lead is used in hard materials or soils containing gravel.

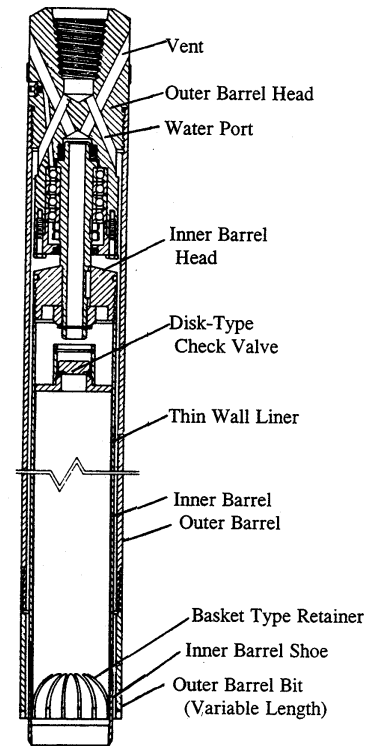
The Denison sampler is used primarily in stiff to hard cohesive soils and in sands, which are not easily sampled with thin-wall samplers owing to the large jacking force required for penetration. Samples of clean sands may be recovered by using driller's mud, a vacuum valve, and a basket catch. The sampler is also suitable for sampling soft clays and silts.

## Modified California Sampler

The Modified California sampler is a large lined tube sampler used in the Midwest and West, but uncommon in the East and South U.S.A. The sampler is thick-walled (area ratio of 77 percent) with an outside diameter of 64 mm (2.5 in) and an inside diameter of 51 mm (2 in). It has a cutting shoe similar to the split-barrel sampler, but with an inside diameter of generally 49 mm (1.93 in). Four 102-mm (4.0-in) long brass liners with inside diameters of 49 mm (1.93 in) are used to contain the sample. In the West, the Modified California sampler is driven with standard penetration energy. The unadjusted blow count is recorded on the boring log. In the Midwest the sampler is generally pushed hydraulically. When pushed, the hydraulic pressure required to advance the Modified California sampler should be noted and recorded on the log. The driving resistance obtained using a Modified California sampler is not equal to the standard penetration test resistance and must be adjusted if comparisons are necessary.

## Continuous Soil Samplers

Several types of continuous soil samplers have been developed. The conventional continuous sampler consists of a 1.5 m (5 ft) long thick-walled tube which obtains "continuous" samples of soil as hollow-stem augers are advanced into soil formations. These systems use bearings or fixed hexagonal rods to restrain or reduce rotation of the continuous sampler as the hollow-stem augers are advanced and the tube is pushed into undisturbed soil below the augers. Recently, continuous hydraulic push samplers have been developed that are quick & economical (e.g., Geoprobe, Powerprobe). These samplers have inside diameters ranging from 15 mm (0.6 in) to 38.1 mm (1.5 in). A steel mandrel is pushed into the ground at a steady rate and the soil is recovered within disposable plastic liners. These devices typically are stand alone and do not require any drilling. If hard layers are encountered, a percussive vibrating procedure is used for penetration.



**Figure 3-16. Denison Double-Tube Core Barrel Soil Sampler**  
(Courtesy of Sprague & Henwood, Inc.)

The continuous samples are generally disturbed and therefore are only appropriate for visual observation, index tests, and classification-type laboratory tests (moisture, density). Continuous samplers have been shown to work well in most clayey soils and in soils with thin sand layers. Less success is typically observed when sampling cohesionless soil below the groundwater level, soft soils, or samples that swell following sampling although modifications are available to increase sample recovery. Information is limited regarding the suitability of the continuous samples for strength and consolidation tests and therefore must be used with caution.

### **Other Soil Samplers**

A variety of special samplers are available to obtain samples of soil and soft rocks. These methods include the retractable plug, Sherbrooke, and Laval samplers. These sampling methods are used in difficult soils where the more routine methods do not recover samples.

### **Bulk Samples**

Bulk samples are suitable for soil classification, index testing, R-value, compaction, California Bearing Ratio (CBR), and tests used to quantify the properties of compacted geomaterials. The bulk samples may be obtained using hand tools without any precautions to minimize sample disturbance. The sample may be taken from the base or walls of a test pit or a trench, from drill cuttings, from a hole dug with a shovel and other hand tools, by backhoe, or from a stockpile. The sample should be put into a container that will retain all of the particle sizes. For large samples, plastic or metal buckets or metal barrels are used; for smaller samples, heavy plastic bags that can be sealed to maintain the water content of the samples are used.

Usually, the bulk sample provides representative materials that will serve as borrow for controlled fill in construction. Laboratory testing for soil properties will then rely on compacted specimens. If the material is relatively homogeneous, then bulk samples may be taken equally well by hand or by machine. However, in stratified materials, hand excavation may be required. In the sampling of such materials it is necessary to consider the manner in which the material will be excavated for construction. If it is likely that the material will be removed layer by layer through the use of scrapers, samples of each individual material will be required and hand excavation from base or wall of the pit may be a necessity to prevent unwanted mixing of the soils. If, on the other hand, the material is to be excavated from a vertical face, then the sampling must be done in a manner that will produce a mixture having the same relative amounts of each layer as will be obtained during the borrow area excavation. This can usually be accomplished by hand-excavating a shallow trench down the walls of the test pit within the depth range of the materials to be mixed.

### **Block Samples**

For projects where the determination of the undisturbed properties is very critical, and where the soil layers of interest are accessible, undisturbed block samples can be of great value. Of all the undisturbed testing methods discussed in this manual, properly-obtained block samples produce samples with the least amount of disturbance. Such samples can be obtained from the hillsides, cuts, test pits, tunnel walls and other exposed sidewalls. Undisturbed block sampling is limited to cohesive soils and rocks. The procedures used for obtaining undisturbed samples vary from cutting large blocks of soil using a combination of shovels, hand tools and wire saws, to using small knives and spatulas to obtain small blocks.

In addition, special down-hole block sampling methods have been developed to better obtain samples in their in-situ condition. For cohesive soils, the Sherbrooke sampler has been developed and is able to obtain samples 250 mm (9.85 in) diameter and 350 mm (13.78 in) height (Lefebvre and Poulin 1979). In-situ freezing methods for saturated granular soils and resin impregnation methods have been implemented to “lock” the soil in the in-situ condition prior to sampling. When implemented, these methods have been

shown to produce high quality undisturbed samples. However, the methods are rather involved and time consuming and therefore have not seen widespread use in practice.

Once samples are obtained and transported to the laboratory in suitable containers, they are trimmed to appropriate size and shape for testing. Block samples should be wrapped with a household plastic membrane and heavy duty foil and stored in block form and only trimmed shortly before testing. Every sample must be identified with the following information: project number, boring or exploration pit number, sample number, sample depth, and orientation.

### **3.1.4 Sampling Interval and Appropriate Type of Sampler**

In general, SPT samples are taken in both granular and cohesive soils, and thin-walled tube samples are taken in cohesive soils. The sampling interval will vary between individual projects and between regions. A common practice is to obtain split barrel samples at 0.75 m (2.5 ft) intervals in the upper 3 m (10 ft) and at 1.5 m (5 ft) intervals below 3 m (10 ft). In some instances, a greater sample interval, often 3 m (10 ft), is allowed below depths of 30 m (100 ft). In other cases, continuous samples may be required for some portion of the boring.

In cohesive soils, at least one undisturbed soil sample should be obtained from each different stratum encountered. If a uniform cohesive soil deposit extends for a considerable depth, additional undisturbed samples are commonly obtained at 3 m (10 ft) to 6 m (20 ft) intervals. Where borings are widely spaced, it may be appropriate to obtain undisturbed samples in each boring; however, for closely spaced borings, or in deposits which are generally uniform in lateral extent, undisturbed samples are commonly obtained only in selected borings. In erratic geologic formations or thin clay layers it is sometimes necessary to drill a separate boring adjacent to a previously completed boring to obtain an undisturbed sample from a specific depth which may have been missed in the first boring.

### **3.1.5 Sample Recovery**

Occasionally, sampling is attempted and little or no material is recovered. In cases where a split barrel, or an other disturbed-type sample is to be obtained, it is appropriate to make a second attempt to recover the soil sample immediately following the first failed attempt. In such instances, the sampling device is often modified to include a retainer basket, a hinged trap valve, or other measures to help retain the material within the sampler.

In cases where an undisturbed sample is desired, the field supervisor should direct the driller to drill to the bottom of the attempted sampling interval and repeat the sampling attempt. The method of sampling should be reviewed, and the sampling equipment should be checked to understand why no sample was recovered (such as a plugged ball valve). It may be appropriate to change the sampling method and/or the sampling equipment, such as waiting a longer period of time before extracting the sampler, extracting the sampler more slowly and with greater care, etc. This process should be repeated or a second boring may be advanced to obtain a sample at the same depth.

### **3.1.6 Sample Identification**

Every sample which is attempted, whether recovered or not, should be assigned a unique number composed of designators for the project number or name, boring number, sequential sample attempt number, and sample depth. Where tube samples are obtained, any disturbed tubes should be clearly marked with the sample identification number and the top and bottom of the sample labeled.

### 3.1.7 Relative Strength Tests

In addition to the visual observations of soil consistency, a pocket (hand) penetrometer can be used to estimate the strength of soil samples. The hand penetrometer estimates the unconfined strength and is suitable for firm to very stiff clay soils. A larger foot/adaptor is needed to test softer soils. It should be emphasized that this test does not produce absolute values; rather it should be used as a guide in estimating the relative strength of soils. **Values obtained with a hand penetrometer should not be used in design.** Instead, when the strength of soils (and other engineering properties) is required, in-situ tests and/or a series of laboratory tests (as described in Chapter 7) on undisturbed samples should be performed.

Another useful test device is a torvane, which is a small diameter vane shear testing device that provides an estimate of the shear strength of cohesive soils. Variable diameter vanes are available for use in very soft to very stiff cohesive soils. Again, this field test yields values that can be used for comparison purposes only, and **the torvane results should not be used in any geotechnical engineering analysis or design.**

Testing with a penetrometer or torvane should always be done in natural soils as near as possible to the center of the top or bottom end of the sample. Testing on the sides of extruded samples is not acceptable. ***Strength values obtained from pocket penetrometer or torvane should not be used for design purposes.***

### 3.1.8 Care and Preservation of Undisturbed Soil Samples

Each step in sampling, extruding, storing and testing introduces varying degrees of disturbance to the sample. Proper sampling, handling, and storage methods are essential to minimize disturbances. The geotechnical engineer must be cognizant of disturbance introduced during the various steps in sampling through testing. The field supervisors should be sensitized about disturbance and the consequences. A detailed discussion of sample preservation and transportation is presented in ASTM D 4220 along with a recommended transportation container design.

When tube samples are to be obtained, each tube should be examined to assure that it is not bent, that the cutting edges are not damaged, and that the interior of the tubes are not corroded. If the tube walls are corroded or irregular, or if samples are stored in tubes for long periods of time, the force required to extract the samples sometimes may exceed the shear strength of the sample causing increased sample disturbance.

All samples should be protected from extreme temperatures. Samples should be kept out of direct sunlight and should be covered with wet burlap or other material in hot weather. In winter months, special precautions should be taken to prevent samples from freezing during handling, shipping and storage. As much as is practical, the thin-walled tubes should be kept vertical, with the top of the sample oriented in the up position. If available, the thin-walled tubes should be kept in a carrier with an individual slot for each tube. Padding should be placed below and between the tubes to cushion the tubes and to prevent them from striking one another. The entire carrier should be secured with rope or cable to the body of the transporting vehicle so that the entire case will not tilt or tip over while the vehicle is in motion.

Soil sample extrusion from tubes in the field is an undesired practice and often results in sample swelling and an unnecessary high degree of disturbance. The stress relief undoubtedly allows the specimens to soften and expand. The samples are also more susceptible to handling disturbances during transport to the laboratory. High-quality specimens are best obtained by soil extraction from tubes in the laboratory just prior to consolidation, triaxial, direct shear, permeability, and resonant column testing. However, to save money, some organizations extrude samples in the field in order to re-use the tubes and these samples are often wrapped in aluminum foil. Depending on the pH of the soil, the aluminum foil may react with the surface of the soil and develop a thin layer of discolored soil, thus making visual identification difficult and confusing. It may also result in changes in the moisture distribution across the sample. Even though plastic

sheeting is also susceptible to reacting with the soil contacted, past observation shows that plastic has less effect than foil. Thus it is recommended that extruded soil samples which are to be preserved be wrapped in plastic sheeting and then wrapped with foil. However, if possible, samples should not be extracted from tubes in the field in order to minimize swelling, disturbance, transport, and handling issues.

Storage of undisturbed samples (in or out of tubes) for long periods of time under any condition is not recommended. Storage exceeding one month may substantially alter soil strength & compressibility as measured by lab tests.

## **3.2 EXPLORATION OF ROCK**

The methods used for exploration and investigation of rock include:

- C Drilling
- C Exploration pits (test pits)
- C Geologic mapping
- C Geophysical methods

Core drilling which is used to obtain intact samples of rock for testing purposes and for assessing rock quality and structure, is the primary investigative method. Test pits, non-core drilling, and geophysical methods are often used to identify the top of rock.

Geophysical methods such as seismic refraction and ground penetrating radar (GPR) may be used to obtain the depth to rock. Finally, geologic mapping of rock exposures or outcrops provides a means for assessing the composition and discontinuities of rock strata on a large scale which may be valuable for many engineering applications particularly rock slope design. This section contains a discussion of drilling and geologic mapping. Some geophysical methods are discussed in section 5.7.

### **3.2.1 Rock Drilling and Sampling**

Where borings must extend into weathered and unweathered rock formations, rock drilling and sampling procedures are required. The use of ISRM (International Society for Rock Mechanics) Commission on Standardization of Laboratory and Field Tests (1978, 1981) guidelines are recommended for detailed guidance for rock drilling, coring, sampling, and logging of boreholes in rock masses. This section provides an abbreviated discussion of rock drilling and sampling methods.

Defining the top of rock from drilling operations can be difficult, especially where large boulders exist, below irregular residual soil profiles, and in karst terrain. In all cases, the determination of the top of rock must be done with care, as an improper identification of the top of rock may lead to miscalculated rock excavation volume or erroneous pile length. As per ASTM D 2113, core drilling procedures are used when formations are encountered that are too hard to be sampled by soil sampling methods. A penetration of 25 mm (1 in) or less by a 51 mm (2 in) diameter split-barrel sampler following 50 blows using standard penetration energy or other criteria established by the geologist or engineer should indicate that soil sampling methods are not applicable and rock drilling or coring is required. In many instances, geophysical methods, such as seismic refraction, can be used to assist in evaluating the top of rock elevations in an expedient and economical manner. The refraction data can also provide information between confirmatory boring locations.



### 3.2.2 Non-Core (Destructive) Drilling

Non-core rock drilling is a relatively quick and inexpensive means of advancing a boring which can be considered when an intact rock sample is not required. Non-core drilling is typically used for determining the top of rock and is useful in solution cavity identification in karstic terrain. Types of non-core drilling include air-track drilling, down-the-hole percussive drilling, rotary tricone (roller bit) drilling, rotary drag bit drilling, and augering with carbide-tipped bits in very soft rocks. Drilling fluid may be water, mud, foam, or compressed air. Caution should be exercised when using these methods to define the top of soft rock since drilling proceeds rapidly, and cuts weathered and soft rock easily, frequently misrepresenting the top of rock for elevation or pile driving applications.

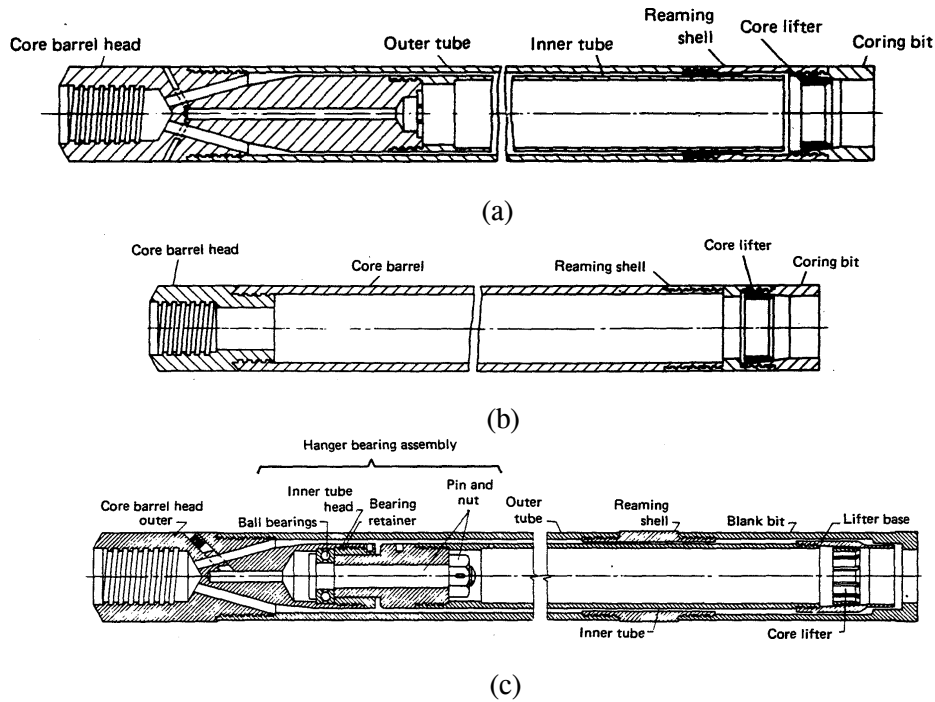
Because intact rock samples are not recovered in non-core drilling, it is particularly important for the field supervisor to carefully record observations during drilling. The following information pertaining to drilling characteristics should be recorded in the remarks section of the boring log:

- C Penetration rate or drilling speed in minutes per 0.3 meter (1 ft)
- C Dropping of rods
- C Changes in drill operation by driller (down pressures, rotation speeds, etc.)
- C Changes in drill bit condition
- C Unusual drilling action (chatter, bouncing, binding, sudden drop)
- C Loss of drilling fluid, color change of fluid, or change in drilling pressure

### 3.2.3 Types of Core Drilling

A detailed discussion of diamond core drilling is presented in AASHTO T 225 and ASTM D 2113. Types of core barrels may be single-tube, double-tube, or triple-tube, as shown in Figures 3-17a,b,c. Table 3-5 presents various types of core barrels available on the market. The standard is a double-tube core barrel, which offers better recovery by isolating the rock core from the drilling fluid stream and consists of an inner and outer core barrel as pictured in Figure 3-18. The inner tube can be rigid or fixed to the core barrel head and rotate around the core or it can be mounted on roller bearings which allow the inner tube to remain stationary while the outer tube rotates. The second or swivel type core barrel is less disturbing to the core as it enters the inner barrel and is useful in coring fractured and friable rock. In some regions only triple tube core barrels are used in rock coring. In a multi-tube system, the inner tube may be longitudinally split to allow observation and removal of the core with reduced disturbance.

Rock coring can be accomplished with either conventional or wireline equipment. With conventional drilling equipment, the entire string of rods and core barrel are brought to the surface after each core run to retrieve the rock core. Wireline drilling equipment allows the inner tube to be uncoupled from the outer tube and raised rapidly to the surface by means of a wire line hoist. The main advantage of wireline drilling over conventional drilling is the increased drilling production resulting from the rapid removal of the core from the hole which, in turn, decreases labor costs. It also provides improved quality of recovered core, particularly in soft rock, since this method avoids rough handling of the core barrel during retrieval of the barrel from the borehole and when the core barrel is opened. (Drillers often hammer on the core barrel to break it from the drill rods and to open the core barrel, causing the core to break.) Wireline drilling can be used on any rock coring job, but typically, it is used on projects where bore holes are greater than 25 m deep and rapid removal of the core from the hole has a greater effect on cost. Wireline drilling is also an effective method for both rock and soil exploration though cobbles or boulders, which tend to shift and block off the bore hole.



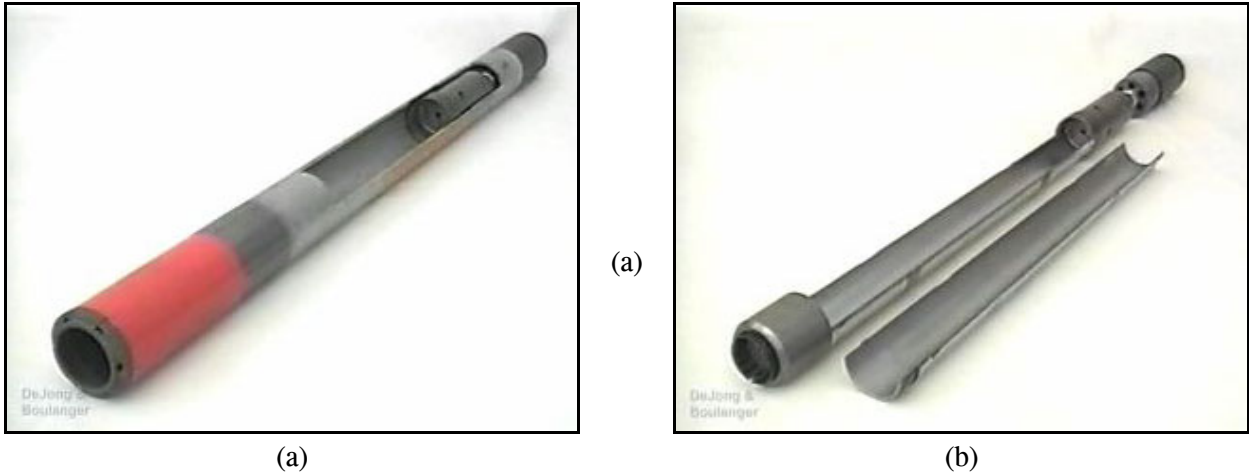
**Figure 3-17. (a) Single Tube Core Barrel; (b) Rigid Type Double Tube Core Barrel; (c) Swivel Type Double Tube Core Barrel, Series “M” with Ball Bearings (Courtesy of Sprague & Henwood, Inc.).**

**TABLE 3-5.**

**DIMENSIONS OF CORE SIZES**

(after Christensen Dia-Min Tools, Inc.)

Size	Diameter of Core mm (in)	Diameter of Borehole mm (in)
EX,EXM	21.5 (0.846)	37.7 (1.484)
EWD3	21.2 (0.835)	37.7 (1.484)
AX	30.1 (1.185)	48.0 (1.890)
AWD4, AWD3	28.9 (1.138)	48.0 (1.890)
AWM	30.1 (1.185)	48.0 (1.890)
AQ Wireline, AV	27.1 (1.067)	48.0 (1.890)
BX	42.0 (1.654)	59.9 (2.358)
BWD4, BWD3	41.0 (1.614)	59.9 (2.358)
BXB Wireline, BWC3	36.4 (1.433)	59.9 (2.358)
BQ Wireline, BV	36.4 (1.433)	59.9 (2.358)
NX	54.7 (2.154)	75.7 (2.980)
NWD4,NWD3	52.3 (2.059)	75.7 (2.980)
NXB Wireline, NWC3	47.6 (1.874)	75.7 (2.980)
NQ Wireline, NV	47.6 (1.874)	75.7 (2.980)
HWD4,HXB Wireline, HWD3	61.1 (2.406)	92.7 (3.650)
HQ Wireline	63.5 (2.500)	96.3 (3.791)
CP, PQ Wireline	85.0 (3.346)	122.6 (4.827)



**Figure 3-18. Double Tube Core Barrel. (a) Outer barrel assembly (b) Inner barrel assembly.**

Although NX is the size most frequently used for engineering explorations, larger and smaller sizes are in use. Generally, a larger core size will produce greater recovery and less mechanical breakage. Because of their effect on core recovery, the size and type of coring equipment used should be carefully recorded in the appropriate places on the boring log.

The length of each core run should be limited to 3 m maximum. Core run lengths should be reduced to 1.5 m (5 ft), or less, just below the rock surface and in highly fractured or weathered rock zones. Shorter core runs often reduce the degree of damage to the core and improve core recovery in poor quality rock.

### **Coring Bits**

The coring bit is the bottommost component of the core barrel assembly. It is the grinding action of this component that cuts the core from the rock mass. Three basic categories of bits are in use: diamond, carbide insert, and sawtooth (Figure 3-19). Coring bits are generally selected by the driller and are often approved by the geotechnical engineer. Bit selection should be based on general knowledge of drill bit performance for the expected formations and the proposed drilling fluid.



**Figure 3-19. Coring Bits. From left to right: Diamond, Carbide, & Sawtooth.**

Diamond coring bits which may be of surface set or impregnated-diamond type are the most versatile since they can produce high-quality cores in rock materials ranging from soft to extremely hard. Compared to other types, diamond bits in general permit more rapid coring and as noted by Hvorslev (1949), exert lower torsional stresses on the core. Lower torsional stresses permit the retrieval of longer cores and cores of small diameter. The wide variation in the hardness, abrasiveness, and degree of fracturing encountered in rock has led to the design of bits to meet specific conditions known to exist or encountered at given sites. Thus, wide variations in the quality, size, and spacing of diamonds, in the composition of the metal matrix, in the face

contour, and in the type and number of waterways are found in bits of this type. Similarly, the diamond content and the composition of the metal matrix of impregnated bits are varied to meet differing rock conditions.

Carbide bits use tungsten carbide in lieu of diamonds and are of several types (the standard type is shown in Figure 3-19). Bits of this type are used to core soft to medium-hard rock. They are less expensive than diamond bits. However, the rate of drilling is slower than with diamond bits.

Sawtooth bits consist of teeth cut into the bottom of the bit. The teeth are faced and tipped with a hard metal alloy such as tungsten carbide to provide wear resistance and thereby to increase the life of the bit. Although these bits are less expensive than diamond bits, they do not provide as high a rate of coring and do not have a salvage value. The saw tooth bit is used primarily to core overburden and very soft rock.

An important feature of all bits which should be noted is the type of waterways provided in the bits for passage of drilling fluid. Bits are available with so-called "conventional" waterways, which are passages cut on the interior face of the bit, or with bottom discharge waterways, which are internal and discharge at the bottom face of the bit behind a metal skirt separating the core from the discharge fluid. Bottom discharge bits should be used when coring soft rock or rock having soil-filled joints to prevent erosion of the core by the drilling fluid before the core enters the core barrel.

### **Drilling Fluid**

In many instances, clear water is used as the drilling fluid in rock coring. If drilling mud is required to stabilize collapsing holes or to seal zones when there is loss of drill water, the design engineer, the geologist and the geotechnical engineer should be notified to confirm that the type of drilling mud is acceptable. Drilling mud will clog open joints and fractures, which adversely affects permeability measurements and piezometer installations. Drilling fluid should be contained in a settling basin to remove drill cuttings and to allow recirculation of the fluid. Generally, drilling fluids can be discharged onto the ground surface. However, special precautions or handling may be required if the material is contaminated with oil or other substances and may require disposal off site. Water flow over the ground surface should be avoided, as much as possible.

### **3.2.4 Observation During Core Drilling**

#### **Drilling Rate/Time**

The drilling rate should be monitored and recorded on the boring log in the units of minutes per 0.3 m (1 ft). Only time spent advancing the boring should be used to determine the drilling rate.

#### **Core Photographs**

Cores in the split core barrel should be photographed immediately upon removal from the borehole. A label should be included in the photograph to identify the borehole, the depth interval and the number of the core runs. It may be desirable to get a "close-up" of interesting features in the core. Wetting the surface of the recovered core using a spray bottle and/or sponge prior to photographing will often enhance the color contrasts of the core.

A tape measure or ruler should be placed across the top or bottom edge of the box to provide a scale in the photograph. The tape or ruler should be at least 1 meter (3 ft) long, and it should have relatively large, high contrast markings to be visible in the photograph.

A color bar chart is often desirable in the photograph to provide indications of the effects of variation in film age, film processing, and the ambient light source. The photographer should strive to maintain uniform light conditions from day to day, and those lighting conditions should be compatible with the type of film selected for the project.

### **Rock Classification**

The rock type and its inherent discontinuities, joints, seams, and other facets should be documented. See Section 4.7 for a discussion of rock classification and other information to be recorded for rock core.

### **Recovery**

The core recovery is the length of rock core recovered from a core run, and the recovery ratio is the ratio of the length of core recovered to the total length of the core drilled on a given run, expressed as either a fraction or a percentage. Core length should be measured along the core centerline. When the recovery is less than the length of the core run, the non-recovered section should be assumed to be at the end of the run unless there is reason to suspect otherwise (e.g., weathered zone, drop of rods, plugging during drilling, loss of fluid, and rolled or recut pieces of core). Non-recovery should be marked as NCR (no core recovery) on the boring log, and entries should not be made for bedding, fracturing, or weathering in that interval.

Recoveries greater than 100 percent may occur if core that was not recovered during a run is subsequently recovered in a later run. These should be recorded and adjustments to data should not be made in the field.

### **Rock Quality Designation (RQD)**

The RQD is a modified core recovery percentage in which the lengths of all pieces of sound core over 100 mm (4 in) long are summed and divided by the length of the core run. The correct procedure for measuring RQD is illustrated in Figure 3-20. The RQD is an index of rock quality in that problematic rock that is highly weathered, soft, fractured, sheared, and jointed typically yields lower RQD values. Thus, RQD is simply a measurement of the percentage of "good" rock recovered from an interval of a borehole. It should be noted that the original correlation for RQD (Rock Quality Designation) reported by Deere (1963) was based on measurements made on NX-size core. Experience in recent years reported by Deere and Deere (1989) indicates that cores with diameters both slightly larger and smaller than NX may be used for computing RQD. The wire line cores using NQ, HQ, and PQ are also considered acceptable. The smaller BQ and BX sizes are discouraged because of a higher potential for core breakage and loss.

#### Length Measurements of Core Pieces

The same piece of core could be measured three ways: along the centerline, from tip to tip, or along the fully circular barrel section (Figure 3-21). The recommended procedure is to measure the core length along the centerline. This method is advocated by the International Society for Rock Mechanics (ISRM), Commission on Standardization of Laboratory and Field Tests (1978, 1981). The centerline measurement is preferred because: (1) it results in a standardized RQD not dependent on the core diameter, and (2) it avoids unduly penalizing of the rock quality for cases where the fractures parallel the borehole and are cut by a second set.

Core breaks caused by the drilling process should be fitted together and counted as one piece. Drilling breaks are usually evidenced by rough fresh surfaces. For schistose and laminated rocks, it is often difficult to discern the difference between natural breaks and drilling breaks. When in doubt about a break, it should be considered as natural in order to be conservative in the calculation of RQD for most uses. It is noted that this practice would not be conservative when the RQD is used as part of a ripping or dredging estimate.

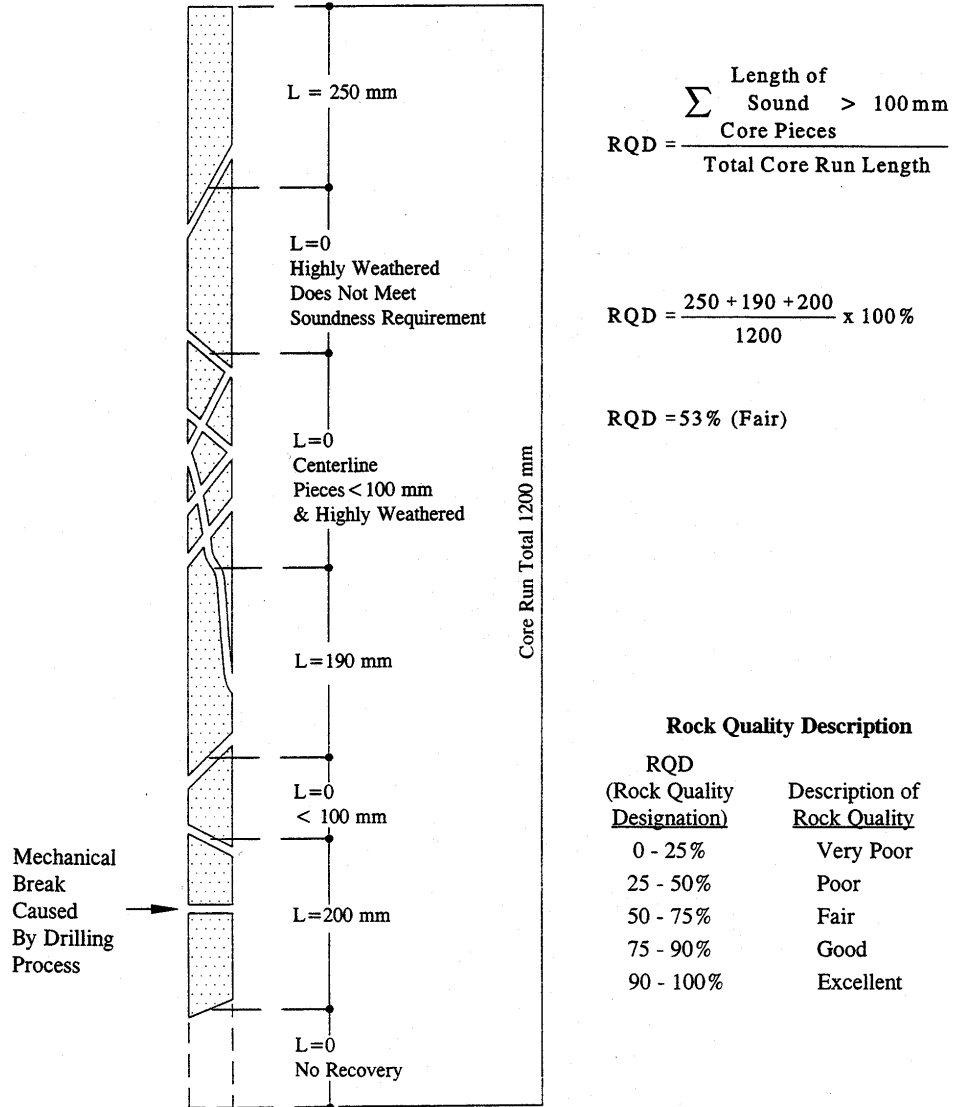
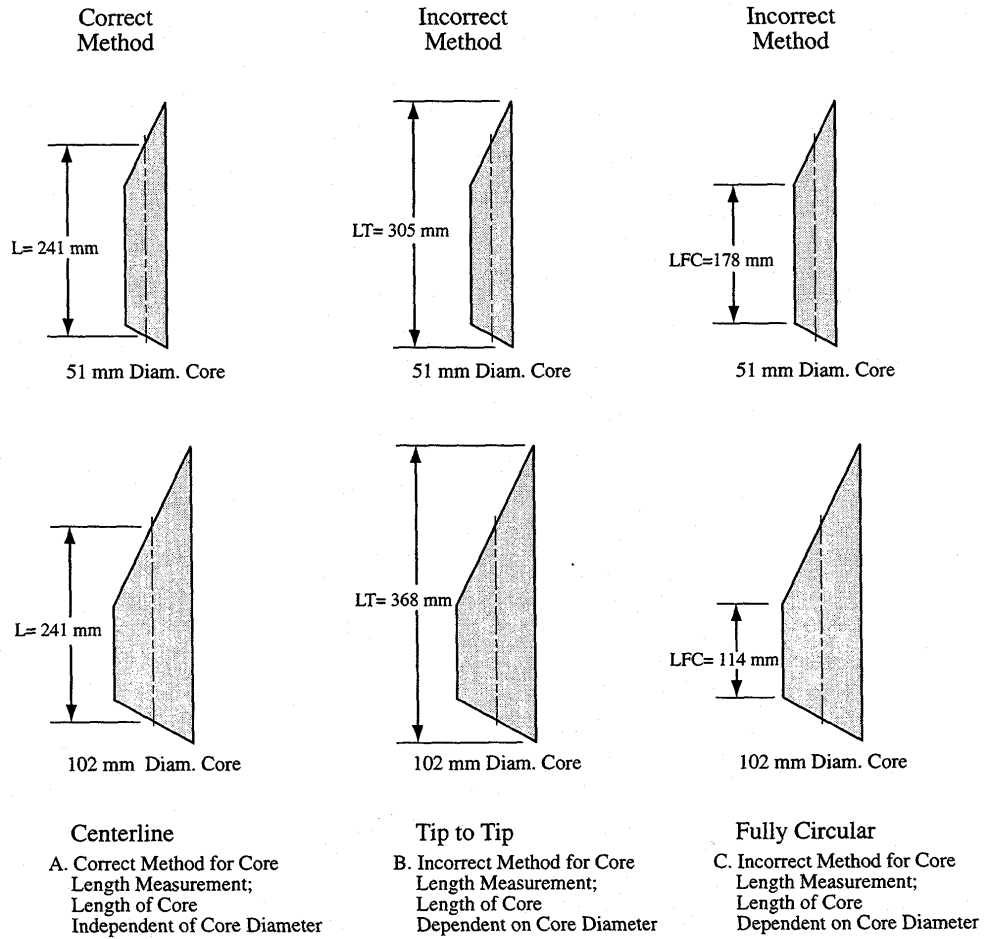


Figure 3-20. Modified Core Recovery as an Index of Rock Mass Quality.

Assessment of Soundness

Pieces of core which are not "hard and sound" should not be counted for the RQD even though they possess the requisite 100 mm (3.94 in) length. The purpose of the soundness requirement is to downgrade the rock quality where the rock has been altered and weakened either by agents of surface weathering or by hydrothermal activity. Obviously, in many instances, a judgment decision must be made as to whether or not the degree of chemical alteration is sufficient to reject the core piece.

One commonly used procedure is not to count a piece of core if there is any doubt about its meeting the soundness requirement (because of discolored or bleached grains, heavy staining, pitting, or weak grain boundaries). This procedure may unduly penalize the rock quality, but it errs on the side of conservatism. A second procedure which occasionally has been used is to include the altered rock within the RQD summed percentage, but to indicate by means of an asterisk (RQD\*) that the soundness requirements have not been met. The advantage of the method is that the RQD\* will provide some indication of the rock quality with respect to the degree of fracturing, while also noting its lack of soundness.



**Figure 3-21. Length Measurement of Core RQD Determination.**

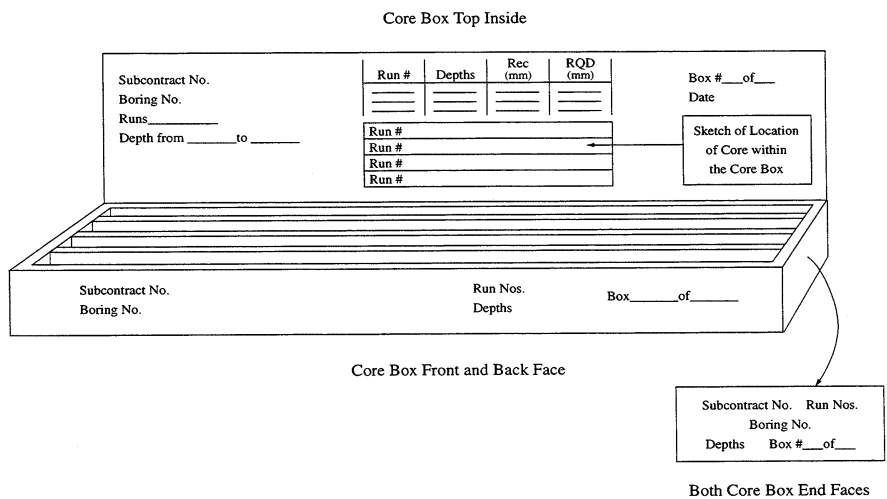
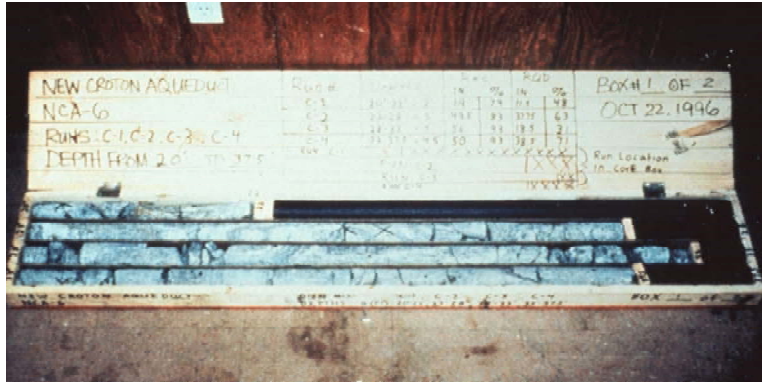
**Drilling Fluid Recovery**

The loss of drilling fluid during the advancement of a boring can be indicative of the presence of open joints, fracture zones or voids in the rock mass being drilled. Therefore, the volumes of fluid losses and the intervals over which they occur should be recorded. For example, "no fluid loss" means that no fluid was lost except through spillage and filling the hole. "Partial fluid loss" means that a return was achieved, but the amount of return was significantly less than the amount being pumped in. "Complete water loss" means that no fluid returned to the surface during the pumping operation. A combination of opinions from the field personnel and the driller on this matter will result in the best estimate.

**Core Handling and Labeling**

Rock cores from geotechnical explorations should be stored in structurally sound core boxes made of wood or corrugated waxed cardboard (Figure 3-22). Wooden boxes should be provided with hinged lids, with the hinges on the upper side of the box and a latch to secure the lid in a closed position.

Cores should be handled carefully during transfer from barrel to box to preserve mating across fractures and fracture-filling materials. Breaks in core that occur during or after the core is transferred to the core box



**Figure 3-22. Core Box for Storage of Recovered Rock and Labeling.**

should be refitted and marked with three short parallel lines across the fracture trace to indicate a mechanical break. Breaks made to fit the core into the core box and breaks made to examine an inner core surface should be marked as such. These deliberate breaks should be avoided unless absolutely necessary. Cores should be placed in the boxes from left to right, top to bottom. When the upper compartment of the box is filled, the next lower (or adjoining) compartment (and so on until the box is filled) should be filled, beginning in each case at the left-hand side. The depths of the top and bottom of the core and each noticeable gap in the formation should be marked by a clearly labeled wooden spacer block.

If there is less than 100 percent core recovery for a run, a cardboard tube spacer of the same length as the core loss should be placed in the core box either at the depth of core loss, if known, or at the bottom of the run. The depth of core loss, if known, or length of core loss should be marked on the spacer with a black permanent marker. The core box labels should be completed using an indelible black marking pen. An example of recommended core box markings is given in Figure 3-22. The core box lid should have identical markings both inside and out, and both exterior ends of the box should be marked as shown. For angled borings, depths marked on core boxes and boring logs should be those measured along the axis of the boring. The angle and orientation of the boring should be noted on the core box and the boring log.



## Care and Preservation of Rock Samples

A detailed discussion of sample preservation and transportation is presented in ASTM D 5079. Four levels of sample protection are identified:

- C Routine care
- C Special care
- C Soil-like care
- C Critical care

Most geotechnical explorations will use routine care in placing rock core in core boxes. ASTM D 5079 suggests enclosing the core in a loose-fitting polyethylene sleeve prior to placing the core in the core box. Special care is considered appropriate if the moisture state of the rock core (especially shale, claystone and siltstone) and the corresponding properties of the core may be affected by exposure. This same procedure can also apply if it is important to maintain fluids other than water in the sample. Critical care is needed to protect samples against shock and vibration or variations in temperature, or both. For soil-like care, samples should be treated as indicated in ASTM D 4220.



**Figure 3-23. Rock Formations Showing Joints, Cut Slopes, Planes, and Stabilization Measures.**

### 3.2.5 Geologic Mapping

Geologic mapping is briefly discussed here, with a more thorough review in FHWA Module 5 (Rock Slopes). Geologic mapping is the systematic collection of local, detailed geologic data, and, for engineering purposes, is used to characterize and document the condition of a rock mass or outcrop. The data derived from geologic mapping is a portion of the data required for design of a cut slope or for stabilization of an existing slope. Geologic mapping can often provide more extensive and less costly information than drilling. The guidelines presented are intended for rock and rock-like materials. Soil and soil-like materials, although occasionally mapped, are not considered in this section.

Qualified personnel trained in geology or engineering geology should perform the mapping or provide supervision and be responsible for the mapping activities and data collection. The first step in geologic mapping is to review and become familiar with the local and regional geology from published and non-published reports, maps and investigations. The mapping team should be knowledgeable of the rock units

and structural and historical geologic aspects of the area. A team approach (minimum of two people, the “buddy system”) is recommended for mapping as a safety precaution when mapping in isolated areas.

Procedures for mapping are outlined in an FHWA Manual (1989) on rock slope design, excavation and stabilization and in ASTM D 4879. The first reference describes the parameters to be considered when mapping for cut slope design, which include:

- C Discontinuity type
- C Discontinuity orientation
- C Discontinuity in filling
- C Surface properties
- C Discontinuity spacing
- C Persistence
- C Other rock mass parameters

These parameters can be easily recorded on a structural mapping coding form shown in Figure 3-24. ASTM D 4879 also describes similar parameters and presents commonly used geologic symbols for mapping purposes. It also presents a suggested report outline. Presentation of discontinuity orientation data can be graphically plotted using stereographic projections. These projections are very useful in rock slope stability analyses. Chapter 3 (Graphical presentation of geological data) in the FHWA manual cited above describes the stereographic projection methods in detail.

### **3.3 BORING CLOSURE**

All borings should be properly closed at the completion of the field exploration. This is typically required for safety considerations and to prevent cross contamination of soil strata and groundwater. Boring closure is particularly important for tunnel projects since an open borehole exposed during tunneling may lead to uncontrolled inflow of water or escape of compressed air.

In many parts of the country, methods to be used for the closure of boreholes are regulated by state agencies. National Cooperative Highway Research Program Report No. 378 (1995) titled “Recommended Guidelines for Sealing Geotechnical Holes” contains extensive information on sealing and grouting. The regulations in general, require that any time groundwater or contamination is encountered the borehole be grouted using a mixture of powdered bentonite, Portland cement and potable water. Some state agencies require grouting of all boreholes exceeding a certain depth. The geotechnical engineer and the field supervisor should be knowledgeable about local requirements prior to commencing the borings.

It is good practice to grout all boreholes. Holes in pavements and slabs should be filled with quick setting concrete, or with asphaltic concrete, as appropriate. Backfilling of boreholes is generally accomplished using a grout mixture. The grout mix is normally pumped through drill rods or other pipes inserted into the borehole. In boreholes filled with water or other drilling fluids the tremied grout will displace the drill fluid. Provisions should be made to collect and dispose of all displaced drill fluid and waste grout.

### **3.4 SAFETY GUIDELINES FOR GEOTECHNICAL BORINGS**

All field personnel, including geologists, engineers, technicians, and drill crews, should be familiar with the general health and safety procedures, as well as any additional requirements of the project or governing agency.

Discontinuity data  
 Sheet No.  of

Day  Month  Year   
 Inspector

**NATURE AND ORIENTATION OF DISCONTINUITY**

Station or No.	Dip	Dip direction	Persistence	Aperture	Nature of filling	Strength of filling	Surface Roughness	Trend of lineation	Waviness wavelength	Waviness amplitude	Water Flow	Remarks

Type	Persistence	Aperture	Nature of filling	Compressive strength of infilling	MPa	Roughness	Seepage Rating	Description	Water Flow (Infilled)	Water Flow (Filled)
1. Fault zone	1. Very low persistence <1 m	1. Very tight (<0.1 mm)	1. Clean	1. Very strong rock	>200	1. Rough (or irregular), stepped	I	The discontinuity is very tight and dry, water flow along it does not appear possible.	W1 The filling materials are heavily consolidated and dry; significant flow appears unlikely due to very low permeability.	
2. Fault	2. Low Persistence 1-3 m	2. Tight (0.1-0.25 mm)	2. Surface staining	2. Strong rock	100-200	2. Smooth, stepped				
3. Joint	3. Medium persistence 3-10 m	3. Partly open (0.25-0.5 mm)	3. Non-cohesive	3. Moderately strong rock or clay matrix	50-100	3. Stickensided stepped				
4. Cleavage	4. High persistence 10-20 m	4. Open (0.5-2.5 mm)	4. Inactive clay	4. Moderately weak rock	25-50	4. Rough (or irregular), undulating	II	The discontinuity is dry with no evidence of water flow.	W2 The filling materials are damp, but no free water is present.	
5. Shear	5. Very high persistence >20 m	5. Moderately wide (2.5-10 mm)	5. Swelling clay or clay matrix	5. Very weak rock	1-25	5. Smooth, undulating				
6. Fissure		6. Open (0.5-2.5 mm)	6. Cemented	6. Very stiff soil	0.6-1.0	6. Stickensided, undulating	III	The discontinuity is dry but shows evidence of water flow, i.e. rust staining, etc.	W3 The filling materials are wet; occasional drops of water.	
7. Tension crack		7. Moderately wide (2.5-10 mm)	7. Chlorite, tale, or gypsum	7. Stiff soil	0.15-0.6	7. Rough (or irregular), planar	IV	The discontinuity is damp but no free water is present.	W4 The filling materials show signs of outwash, continuous flow of water (estimate liters/minute).	
8. Foliation		8. Extremely wide (10 - 100 cm)	8. Others - specify	8. Firm soil	0.08-0.15	8. Smooth, planar	V	The discontinuity shows seepage, occasional drops of water, but no continuous flow.	W5 The filling materials are washed out locally; considerable water flow along out-wash channels (estimate liters/minute and describe pressure, i.e. low, medium, high).	
9. Bedding		9. Cavernous		9. Soft soil	0.04-0.08	9. Stickensided	VI	The discontinuity shows a continuous flow of water (Estimate l/min and describe pressure, i.e. low, medium, high).		

**Figure 3-24. (a) Structural Mapping Coding Form for Discontinuity Survey Data.**

ROCK MASS DESCRIPTION			SLOPE STABILITY ASSESSMENT		
<b>GENERAL INFORMATION</b> Subdivision: <input type="text"/> Km: <input type="text"/> Date: <input type="text"/> Day: <input type="text"/> Month: <input type="text"/> Year: <input type="text"/> Inspector: <input type="text"/>			<b>Inspection Rating</b> <input type="checkbox"/> <b>Required Action</b> <input type="checkbox"/> <b>Assessment of Site Conditions</b> <input type="checkbox"/>		
Locality Type: <input type="checkbox"/> Slope Length: <input type="text"/> No. of supplementary sheets: <input type="text"/> 1. Natural exposure      2. Construction excavation      3. Trial pit      4. Trench      5. Adit      6. Tunnel Slope Height: <input type="text"/> Sketch: <input type="checkbox"/> Photograph: <input type="checkbox"/> 0. No      1. Yes			<b>Inspection Rating</b> 1. Urgent - recent fall/visual evidence of significant movement - hazard 2. Priority - evidence of movement or change in conditions from previous years 3. Observe - identification of a specific area of potential instability 4. OK - no potential instability		
<b>ROCK MATERIAL INFORMATION</b> Color: <input type="text"/> <input type="text"/> <input type="text"/> 1. Light      2. Dark 3. Pinkish      4. Reddish      5. Yellowish      6. Brownish      7. Olive      8. Greenish      9. Bluish      10. Greyish      0. Black Grain Size: <input type="text"/> <input type="text"/> <input type="text"/> 1. Very coarse (> 60 mm) 2. Coarse (2-60 mm) 3. Medium (60 μ-20 mm) 4. Fine (2-60 μ) 5. Very fine (< 2μ)			<b>Inspection Rating</b> 1. Inspect - inspection required within the next three months approximately - state time 2. Immediate Work - stabilization work of specific location required in current year - state time 3. Slow Order - traffic at speed/stopped/watchman until stabilization work carried out 4. 1-5 Years - possible stabilization - state time 5. Long term - substantial stabilization program 6. No Action		
<b>ROCK MASS INFORMATION</b> Fabric: <input type="text"/> <input type="text"/> <input type="text"/> <input type="text"/> <input type="text"/> 1. Blocky      2. Tabular      3. Columnar 4. Very large (> 8 m <sup>3</sup> ) 5. Large (0.5-8 m <sup>3</sup> ) 6. Medium (0.008-0.2 m <sup>3</sup> ) 7. Small (0.0002-0.008 m <sup>3</sup> ) 8. Very small (< 0.0002 m <sup>3</sup> )			<b>Required Action</b> 1. Open fractures indicative of past movement. 2. Fractures oriented such that blocks could slide or topple on to the track. 3. Evidence of recent movement. 4. Probability that rockfall/slide would be of sufficient size to reach tracks and cause derailment. 5. Serious consequence of derailment (e.g. track on level ground or supported by retaining wall).		
<b>ROCK MASS INFORMATION</b> State of weathering: <input type="text"/> <input type="text"/> <input type="text"/> 1. Fresh 2. Slightly 3. Moderately 4. Highly 5. Completely 6. Residual soil			<b>Method of determining compressive strength</b> <input type="checkbox"/> <input type="checkbox"/> <input type="checkbox"/> <input type="checkbox"/> <input type="checkbox"/> 1. Measured 2. Assessed 3. Qualifying terms to describe rock 4. Moderate (200-600 mm) 5. Wide (600-2000 mm) 6. Very wide (2000-6000 mm) 7. Ext. Wide (> 6000 mm)		
<b>ROCK MASS INFORMATION</b> Compressive strength: <input type="text"/> <input type="text"/> <input type="text"/> <input type="text"/> 1. Very strong rock (> 200 MPa) 2. Strong rock (100-200 MPa) 3. Moderately strong rock (50-100 MPa) 4. Moderately weak rock (2-30 MPa) 5. Very weak rock (0-25 MPa) 6. Very stiff soil (0.15-0.6 MPa) 7. Firm soil (0.08-0.15 MPa) 8. Soft soil (0.04-0.08 MPa) 9. Very soft soil (< 0.04 MPa)			<b>Remarks</b> (consequences, stabilization, rockfalls, slide fence)		
<b>LINE SURVEYS TO DETERMINE DISCONTINUITY SPACINGS</b> Plunge of line: <input type="text"/> <input type="text"/> <input type="text"/> <input type="text"/> Trend of line: <input type="text"/> <input type="text"/> <input type="text"/> <input type="text"/> Length of line (m): <input type="text"/> <input type="text"/> <input type="text"/> <input type="text"/> No. of fractures: <input type="text"/> <input type="text"/> <input type="text"/> <input type="text"/> Spacing: <input type="text"/> <input type="text"/> <input type="text"/> <input type="text"/>			<b>Discontinuity spacing</b> 1. Extremely close (< 20 mm) 2. Very close (20-60 mm) 3. Close (60-200 mm)		

Figure 3-24. (b) Structural Mapping Coding Form for Slope Assessment.

Typical safety guidelines for drilling into soil and rock are presented in Appendix A. Minimum protective gear for all personnel should include hard hat, safety boots, eye protection, and gloves.

It is not unusual to encounter unknown or unexpected environmental problems during a site investigation. For example, discolored soils or rock fragments from prior spills, or contaminated groundwater may be detected. The geotechnical engineer and the field supervisor should attempt to identify possible contamination sources prior to initiating fieldwork. Based on this evaluation, a decision should be made whether a site safety plan should be prepared. Environmental problems can adversely affect investigation schedules and cost, and may require the obtaining of permits from State or Federal agencies prior to drilling or sampling.

At geotechnical exploration sites where unknown or unexpected contamination is found during the fieldwork, the following steps should be taken:

1. The field supervisor should immediately stop drilling and notify the geotechnical engineer. The field supervisor should identify the evidence of contamination, the depth of contamination, and the estimated depth to the water table (if known). If liquid-phase product is encountered (at or above the water table), the boring should be abandoned immediately and sealed with hydrated bentonite chips or grout.
2. The project manager should advise the environmental officer of the governing agency and decide if special health and safety protocol should be implemented. Initial actions may require demobilization from the site.

### **3.5 COMMON SENSE DRILLING**

Drillers performance is commonly judged by the quantity of production rather than the quality of the borings and samples. Not surprisingly, similar problems develop throughout the country. All geotechnical engineers and field supervisors need to be trained to recognize these problems, and to assure that field information and samples are properly obtained. The following is a partial listing of common errors:

- C Not properly cleaning slough and cuttings from the bottom of the bore hole. The driller should not sample through slough, but should re-enter the boring and remove the slough before proceeding.
- C In cohesionless soils, jetting should not be used to advance a split barrel sampler to the bottom of the boring.
- C Poor sample recovery due to use of improper sampling equipment or procedures.
- C When sampling soft or non-cohesive soils with thin wall tube samplers (i.e., Shelby tube) it may not be possible to recover an undisturbed sample because the sample will not stay in the barrel. The driller should be clearly instructed not to force recovery by overdriving the sampling barrel to grab a sample.
- C Improper sample types or insufficient quantity of samples. The driller should be given clear instructions regarding the sample frequency and types of samples required. The field supervisor must keep track of the depth of the borings at all stages of the exploration to confirm proper sampling of the soil and/or rock formations.
- C Improper hole stabilization. Rotary wash borings and hollow-stem auger borings below the groundwater level require a head of water to be maintained at the top of the casing/augers at all times. When the drill rods are withdrawn or as the hollow stem auger is advanced, this water level will tend to drop, and must be maintained by the addition of more drilling fluid. Without this precaution, the sides of the boring may collapse or the bottom of the boring may heave.

- C Sampler rods lowered into the boring with pipe wrenches rather than hoisting plug. The rods may be inclined and the sampler can hit the boring walls, filling the sampler with debris.
- C Improper procedures while performing Standard Penetration Tests. The field supervisor and driller must assure that the proper weight and hammer drop are being used, and that friction at the cathead and along any hammer guides is minimized.



**Figure 3-25. Views of Rotary Drill Rigs Mounted on Trucks for Soil & Rock Exploration.**

## CHAPTER 4.0

### BORING LOG PREPARATION

#### 4.1 GENERAL

The boring log is the basic record of almost every geotechnical exploration and provides a detailed record of the work performed and the findings of the investigation. The field log should be written or printed legibly, and should be kept as clean as is practical. All appropriate portions of the logs should be completed in the field prior to completion of the field exploration.

A wide variety of drilling forms are used by various agencies. The specific forms to be used for a given type of boring will depend on local practice. Typical boring log, core boring log and test pit log forms endorsed by the ASCE Soil Mechanics & Foundations Engineering Committee are presented in Figures 4-1 through 4-3, respectively. A proposed legend for soil boring logs is given in Figure 4-4 and for core boring logs in Figure 4-5. This chapter presents guidelines for completion of the boring log forms, preparation of soil descriptions and classifications, and preparation of rock descriptions and classifications.

A boring log is a description of exploration procedures and subsurface conditions encountered during drilling, sampling and coring. Following is a brief list of items which should be included in the logs. These items are discussed in detail in subsequent sections:

- C Topographic survey data including boring location and surface elevation, and bench mark location and datum, if available.
- C An accurate record of any deviation in the planned boring locations.
- C Identification of the subsoils and bedrock including density, consistency, color, moisture, structure, geologic origin.
- C The depths of the various generalized soil and rock strata encountered.
- C Sampler type, depth, penetration, and recovery.
- C Sampling resistance in terms of hydraulic pressure or blows per depth of sampler penetration. Size and type of hammer. Height of drop.
- C Soil sampling interval and recovery.
- C Rock core run numbers, depths & lengths, core recovery, and Rock Quality Designation (RQD)
- C Type of drilling operation used to advance and stabilize the hole.
- C Comparative resistance to drilling.
- C Loss of drilling fluid.
- C Water level observations with remarks on possible variations due to tides and river levels.

<b>Project:</b> <b>Project Location:</b> <b>Project Number:</b>	<b>Log of Boring</b> ____ Sheet 1 of ____
---	--

Date(s) Drilled	Logged By	Checked By
Drilling Method	Drill Bit Size/Type	Total Depth Drilled (meters)
Drill Rig Type	Drilled By	Hammer Weight/Drop (N/m)
Apparent Groundwater Depth ____ m ATD ____ m after ____ hrs ____ m after ____ hrs		Surface Elevation (meters)
Comments	Borehole Backfill	Elevation Datum

Depth, meters	SAMPLES				MATERIAL DESCRIPTION and other remarks	Elevation, meters	Pocket Pen., kPa	Water Content, %	Liquid Limit	Plasticity Index	Other Tests
	Location	Type	Number	Sampling Resistance							
0											
1											
2											
3											
4											

Template: Proj ID:

Printed:

Figure 4-1. Representative Boring Log Form.



<b>Project:</b> <b>Project Location:</b> <b>Project Number:</b>	<b>Log of Core Boring</b> ____ Sheet 1 of ____
---	---

Date(s) Drilled	Logged By	Checked By
Drilling Method	Drill Bit Size/Type	Total Depth Drilled (meters)
Drill Rig Type	Drilled By	Inclination from Vertical/Bearing
Apparent Groundwater Depth ____ m ATD ____ m after ____ hrs ____ m after ____ hrs		Approx. Surface Elevation (meters)
Comments		Borehole Backfill

Depth, meters	Elevation, meters	ROCK CORE							MATERIAL DESCRIPTION	Packer Tests	Laboratory Tests	Drill Rate, meters/hour	FIELD NOTES
		Run No.	Box No.	Recovery, %	Frac. Freq.	R Q D, %	Fracture Drawing/Number	Lithology					
0													
1													

Template:

Proj ID:

Printed:

Figure 4-2. Representative Core Boring Log.

<b>Project:</b> <b>Project Location:</b> <b>Project Number:</b>	<b>Log of  Exploration Pit ____</b>
---	---

Date(s) Excavated	Logged By	Checked By
Approximate Length (meters)	Approximate Width (meters)	Approximate Depth (meters)
Excavation Equipment	Excavation Contractor	Approximate Pit Trend
Groundwater Level (meters)	Date Measured	Approx. Surface Elevation (meters)
Comments		

Depth, meters	Elevation, meters	Sample Type and Number	Pocket Pen., kPa	Graphic Log	MATERIAL DESCRIPTION and other remarks	Water Content, %	Other Tests
0							
1							
2							
3							
4							

Template: Proj ID:

Printed:

**Figure 4-3. Representative Exploration Pit Log.**

Depth, meters	SAMPLES			MATERIAL DESCRIPTION and other remarks	Elevation, meters	Pocket Pen., kPa.	Water Content, %	Liquid Limit	Plasticity Index	Other Tests
	Location	Type	Number							
0										
	<b>DESCRIPTIONS OF SAMPLER AND FIELD TEST CODES</b>									
1	S	1	15	The number of blows (15) of a 63.6 Kgr hammer falling 750 mm used to drive a 50 mm O.D. split-barrel sampler for the last 300 mm of penetration.						
2	S	2	50/150	Number of blows (50) used to drive the split-barrel a certain number of millimeters (150).						
3	P	3	1724	Thin-wall tube pushed hydraulically, using a certain pressure (1,724 kPa) to push the last 150 mm.						
4	A	4		<b>SAMPLER CODES</b> P - Thin-wall tube sample. C - Denison or Pitcher-type core-barrel sample. Ps - Piston sample. A - Auger sample. BS - Bulk sample. SS - Standard spoon sample. CL - California liner sample.						
5	NX 65	5	40	BX - Rock cored with BX core barrel, which obtains a 41 mm-diameter core. NX - Rock cored with NX core barrel, which obtains a 53 mm-diameter core. 65 - Percentage (65) of rock core recovered. 40 - Rock Quality Designation (RQD) percentage (40).						
6	S			Sample recovered: indicated by blackened box in "Location" column.						
7	NR			Sample not recovered: indicated by vertical bar in "Location" column and "NR" (no recovery) in "Type" column.						
				<b>OTHER FIELD TEST DESIGNATIONS</b> FV - Field vane shear test. PMT - Pressuremeter test. DMT - Dilatometer test. BHS - Borehole shear test.						
					<b>ABBREVIATIONS FOR "OTHER TESTS" COLUMN</b>					
					C - Consolidation and specific gravity tests. D - Maximum and minimum density. DS - Direct shear test. G - Specific gravity test. K - Permeability test. M - Mechanical (sieve or hydrometer) analysis. T - Triaxial compression test. TV - Torvane shear test. U - Unconfined compression test. W - Unit weight and natural moisture content. X - Special tests performed - see laboratory test results.					

Template: MS9K Proj ID: KEY

Point ID: MS9K Printed: MAY 28 97

Figure 4-4. Proposed Key to Boring Log (Continued on Page 4-6).

**Project:**  
**Project Location:**  
**Project Number:**

## Key to Soil Symbols and Terms

Sheet 2 of 2

### TERMS DESCRIBING CONSISTENCY OR CONDITION

**COARSE-GRAINED SOILS** (major portion retained on No. 200 sieve): includes (1) clean gravels and sands and (2) silty or clayey gravels and sands. Condition is rated according to relative density as determined by laboratory tests or standard penetration resistance tests.

Descriptive Term	Relative Density	SPT Blow Count
Very loose	0 to 15%	< 4
Loose	15 to 35%	4 to 10
Medium dense	35 to 65%	10 to 30
Dense	65 to 85%	30 to 50
Very dense	85 to 100%	> 50

**FINE-GRAINED SOILS** (major portion passing on No. 200 sieve): includes (1) inorganic and organic silts and clays, (2) gravelly, sandy, or silty clays, and (3) clayey silts. Consistency is rated according to shearing strength, as indicated by penetrometer readings, SPT blow count, or unconfined compression tests.

Descriptive Term	Unconfined Compressive Strength, kPa	SPT Blow Count
Very soft	< 25	< 2
Soft	25 to 50	2 to 4
Medium stiff	50 to 100	4 to 8
Stiff	100 to 200	8 to 15
Very stiff	200 to 400	15 to 30
Hard	> 400	> 30

### GENERAL NOTES

- Classifications are based on the Unified Soil Classification System and include consistency, moisture, and color. Field descriptions have been modified to reflect results of laboratory tests where deemed appropriate.
- Surface elevations are based on topographic maps and estimated locations.
- Descriptions on these boring logs apply only at the specific boring locations and at the time the borings were made. They are not warranted to be representative of subsurface conditions at other locations or times.

Major Divisions	Group Symbols	Typical Names	Laboratory Classification Criteria	Particle Size	Material					
<b>Coarse-Grained Soils</b> (More than half of material is larger than No. 200 sieve size)  <b>Gravels</b> (More than half of coarse fraction is larger than No. 4 sieve size)  <b>Sands</b> (More than half of coarse fraction is smaller than No. 4 sieve size)  Clean sands (little or no fines) Sands with fines (Appreciable amount of fines) Clean gravels (little or no fines) Gravels with fines (Appreciable amount of fines)	GW	Well-graded gravels, gravel-sand mixtures, little or no fines	Determine percentages of sand and gravel from grain-size curve. Depending on percentage of fines (fraction smaller than No. 200 sieve) coarse-grained soils are classified as follows: Less than 5 percent . . . . . GW, GP, SW, SP More than 12 percent . . . . . GM, GC, SM, SC 5 to 12 percent . . . . . Borderline cases requiring dual symbols **	$C_u = \frac{D_{60}}{D_{10}}$ greater than 4; $C_c = \frac{(D_{30})^2}{D_{10} \times D_{60}}$ between 1 and 3  Not meeting all gradation requirements for GW  Atterberg limits below "A" line or P.I. less than 4  Above "A" line with P.I. between 4 and 7 are borderline cases requiring use of dual symbols  $C_u = \frac{D_{60}}{D_{10}}$ greater than 6; $C_c = \frac{(D_{30})^2}{D_{10} \times D_{60}}$ between 1 and 3  Not meeting all gradation requirements for SW  Atterberg limits below "A" line or P.I. less than 4  Above "A" line with P.I. between 4 and 7 are borderline cases requiring use of dual symbols	Sieve size < #200  mm < 0.075  #200 to #40 #40 to #10 #10 to #4	Silt or clay Sand Fine Medium Coarse				
	GP	Poorly-graded gravels, gravel-sand mixtures, little or no fines								
	GM*	Silty gravels, gravel-sand-silt mixtures								
	GC	Clayey gravels, gravel-sand-silt mixtures								
	SW	Well-graded sands, gravelly sands, little or no fines								
	SP	Poorly-graded sands, gravelly sands, little or no fines								
	SM*	Silty sands, sand-silt mixtures								
	SC	Clayey sands, sand-clay mixtures								
	<b>Fine-Grained Soils</b> (More than half of material is smaller than No. 200 sieve size)  <b>Silts and Clays</b> (Liquid limit less than 50)  <b>Silts and Clays</b> (Liquid limit greater than 50)  <b>Highly Organic Soils</b>	ML					Inorganic silts and very fine sands, rock flour, silty or clayey fine sands or clayey silts with slight plasticity	<p style="text-align: center; font-size: x-small;">Plasticity Chart</p>	Sieve #4 to 3/4 in. 3/4 in. to 3 in. 3 in. to 12 in. 12 in. to 36 in.	Gravel Fine Coarse Cobbles Boulders
		CL					Inorganic clays of low to medium plasticity, gravelly clays, sandy clays, silty clays, lean clays			
OL		Organic silts and organic silty clays of low plasticity								
MH		Inorganic silts, micaceous or diatomaceous fine sandy or silty soils, elastic silts								
CH		Inorganic clays of high plasticity, fat clays								
OH		Organic clays of medium to high plasticity, organic silts								
Pt		Peat and other highly organic soils								

\* Division of GM and SM groups into subdivisions of d and u are for roads and airfields only. Subdivision is based on Atterberg Limits: suffix d used when L.L. is 28 or less and the P.I. is 8 or less; the suffix u used when L.L. is greater than 28.  
 \*\* Borderline classifications, used for soils possessing characteristics of two groups, are designated by combinations of group symbols. For example: GW-GC, well-graded gravel-sand mixture with clay binder.

Figure 4-4. Proposed Key for Final Boring Log (continued).

Depth, meters	Elevation, meters	ROCK CORE								MATERIAL DESCRIPTION	Packer Tests	Laboratory Tests	Drill Rate, meters/hour	FIELD NOTES
		Run No.	Box No.	Recovery, %	Frac. Freq.	R Q D, %	Fracture Drawing/ Number	Lithology						
0														
1	2	3	4	5	6	7	8	9	10	11	13	14	15	16
2		1	1	100		80			1	M				Slow drilling
4					0			1		12				

- 1** Depth: Distance (in meters) from the collar of the borehole.
- 2** Elevation: Elevation (in meters) from the collar of the borehole.
- 3** Run No.: Number of the individual coring interval, starting at the top of bedrock.
- 4** Box No.: Number of the core box which contains core from the corresponding run.
- 5** Recovery: Amount (in percent) of core recovered from the coring interval; calculated as the length of core recovered divided by the length of the run.
- 6** Frac. Freq.: (Fracture Frequency) The number of naturally occurring fractures in each foot of core; does not include mechanical breaks, which are considered to be induced by drilling.
- 7** R Q D: (Rock Quality Designation) Amount (in percent) of intact core (pieces of sound core greater than 100 mm in length) in each coring interval; calculated as the sum of the lengths of intact core divided by the length of the run.
- 8** Fracture Drawing: Sketch of the naturally occurring fractures and mechanical breaks, showing the angle of the fractures relative to the cross-sectional axis of the core. "NR" indicates no recovery.
- 9** Fracture Number: Location of each naturally occurring fracture (numbered) and mechanical break (labeled "M"). Naturally occurring fractures are described in Column 11 (keyed by number) using descriptive terms defined on the following page (Items a - h).
- 10** Lithology: A graphic log presentation using symbols to represent differing rock types.
- 11** Description: Lithologic description in this order: rock type, color, texture, grain size, foliation, weathering, strength, and other features; descriptive terms are defined on the following page. A detailed descriptive log of overburden materials is not necessarily provided.
- 12** Discontinuity Description: Abbreviated description of fracture corresponding to number of naturally occurring fracture in Column 9 using terms defined on the following page (Items a - h).
- 13** Packer Tests: A vertical line depicts the interval over which a packer test is performed.
- 14** Laboratory Tests: A vertical line depicts the interval over which core has been removed for laboratory testing. Laboratory tests performed are indicated in Column 16.
- 15** Drill Rate: Rate (in meters per hour) of penetration of drilling. "N/O" indicates rate not observed.
- 16** Field Notes: Comments on drilling, including water loss, reasons for core loss, and use of drilling mud; also, laboratory tests performed on core.

Figure 4-5. Proposed Key to Core Boring Log (Continued on Page 4-8).

<b>Project:</b>	<b>Key to Rock Core Log</b> Sheet 2 of 2
<b>Project Location:</b>	
<b>Project Number:</b>	

Depth, meters	Elevation, meters	ROCK CORE							MATERIAL DESCRIPTION	Packer Tests	Laboratory Tests	Drill Rate, meters/hour	FIELD NOTES
		Run No.	Box No.	Recovery, %	Frac. Freq.	R Q D, %	Fracture Drawing/ Number	Lithology					

**KEY TO DESCRIPTIVE TERMS USED ON CORE LOGS**

**DISCONTINUITY DESCRIPTORS**

- |   |  |  |
|---|--|--|
| <p><b>a</b> Dip of fracture surface measured relative to horizontal</p> <p><b>b</b> <b>Discontinuity Type:</b></p> <ul style="list-style-type: none"> <li>F - Fault</li> <li>J - Joint</li> <li>Sh - Shear</li> <li>Fo - Foliation</li> <li>V - Vein</li> <li>B - Bedding</li> </ul> <p><b>c</b> <b>Discontinuity Width (millimeters):</b></p> <ul style="list-style-type: none"> <li>W - Wide (12.5-50)</li> <li>MW - Moderately Wide (2.5-12.5)</li> <li>N - Narrow (1.25-2.5)</li> <li>VN - Very Narrow (&lt;1.25)</li> <li>T - Tight (0)</li> </ul> <p><b>d</b> <b>Type of Infilling:</b></p> <ul style="list-style-type: none"> <li>Cl - Clay</li> <li>Ca - Calcite</li> <li>Ch - Chlorite</li> <li>Fe - Iron Oxide</li> <li>Gy - Gypsum/Talc</li> <li>H - Healed</li> <li>No - None</li> <li>Py - Pyrite</li> <li>Qz - Quartz</li> <li>Sd - Sand</li> </ul> | <p><b>e</b> <b>Amount of Infilling:</b></p> <ul style="list-style-type: none"> <li>Su - Surface Stain</li> <li>Sp - Spotty</li> <li>Pa - Partially Filled</li> <li>Fi - Filled</li> <li>No - None</li> </ul> <p><b>f</b> <b>Surface Shape of Joint:</b></p> <ul style="list-style-type: none"> <li>Wa - Wavy</li> <li>Pl - Planar</li> <li>St - Stepped</li> <li>Ir - Irregular</li> </ul> <p><b>g</b> <b>Roughness of Surface:</b></p> <ul style="list-style-type: none"> <li>Slk - Slickensided [surface has smooth, glassy finish with visual evidence of striations]</li> <li>S - Smooth [surface appears smooth and feels so to the touch]</li> <li>SR - Slightly Rough [asperities on the discontinuity surfaces are distinguishable and can be felt]</li> <li>R - Rough [some ridges and side-angle steps are evident; asperities are clearly visible, and discontinuity surface feels very abrasive]</li> <li>VR - Very Rough [near-vertical steps and ridges occur on the discontinuity surface]</li> </ul> | <p><b>h</b> <b>Discontinuity Spacing (meters):</b></p> <ul style="list-style-type: none"> <li>EW - Extremely Wide (&gt;20)</li> <li>W - Wide (7-20)</li> <li>M - Moderate (2.5-7)</li> <li>C - Close (0.7-2.5)</li> <li>VC - Very Close (&lt;0.7)</li> </ul> |
|---|--|--|

**ROCK WEATHERING / ALTERATION**

Description	Recognition
Residual Soil	Original minerals of rock have been entirely decomposed to secondary minerals, and original rock fabric is not apparent; material can be easily broken by hand
Completely Weathered/Altered	Original minerals of rock have been almost entirely decomposed to secondary minerals, minerals, although original fabric may be intact; material can be granulated by hand
Highly Weathered/Altered	More than half of the rock is decomposed; rock is weakened so that a minimum 50-mm-diameter sample can be broken readily by hand across rock fabric
Moderately Weathered/Altered	Rock is discolored and noticeably weakened, but less than half is decomposed; a minimum 50-mm-diameter sample cannot be broken readily by hand across rock fabric
Slightly Weathered/Altered	Rock is slightly discolored, but not noticeably lower in strength than fresh rock
Fresh	Rock shows no discoloration, loss of strength, or other effect of weathering/alteration

**ROCK STRENGTH**

Description	Recognition	Approximate Uniaxial Compressive Strength (kPa)
Extremely Weak Rock	Can be indented by thumbnail	250 - 1,000
Very Weak Rock	Can be peeled by pocket knife	1,000 - 5,000
Weak Rock	Can be peeled with difficulty by pocket knife	5,000 - 25,000
Medium Strong Rock	Can be indented 5 mm with sharp end of pick	25,000 - 50,000
Strong Rock	Requires one hammer blow to fracture	50,000 - 100,000
Very Strong Rock	Requires many hammer blows to fracture	100,000 - 250,000
Extremely Strong Rock	Can only be chipped with hammer blows	> 250,000

Template: M4SK Proj ID: KEY

Point ID: COREKEY Printed: MAY 28 97

Figure 4-5. Proposed Key to Core Boring (continued).

- C The date and time that the borings are started, completed, and of water level measurements.
- C Closure of borings.

Boring logs provide the basic information for the selection of test specimens. They provide background data on the natural condition of the formation, on the ground water elevation, appearance of the samples, and the soil or rock stratigraphy at the boring location, as well as areal extent of various deposits or formations. Data from the boring logs are combined with laboratory test results to identify subgrade profiles showing the extent and depth of various materials at the subject site. Soil profiles showing the depth and the location of various types of materials and ground water elevations are plotted for inclusion in the geotechnical engineer's final report and in the plans and specifications. Detailed boring logs including the results of laboratory tests are included in the text of the report.

#### **4.2 PROJECT INFORMATION**

The top of each boring log provides a space for project specific information: name or number of the project, location of the project, drilling contractor (if drilling is contracted out), type of drilling equipment, date and time of work, drilling methods, hammer weight and fall, name of personnel logging the boring, and weather information. All information should be provided on the first sheet of each boring log.

#### **4.3 BORING LOCATIONS AND ELEVATIONS**

The boring location (coordinates and/or station and offset) and ground surface elevation (with datum) must be recorded on each boring log. Procedures discussed in Section 2.5.3 should be used for determining the location and elevation for each boring site.

#### **4.4 STRATIGRAPHY IDENTIFICATION**

The subsurface conditions observed in the soil samples and drill cuttings or perceived through the performance of the drill rig (for example, rig chatter in gravel, or sampler rebounding on a cobble during driving) should be described in the wide central column on the log labeled "Material Description", or in the remarks column, if available. The driller's comments are valuable and should be considered as the boring log is prepared. In addition to the description of individual samples, the boring log should also describe various strata. The record should include a description of each soil layer, with solid horizontal lines drawn to separate adjacent layers. It is important that a detailed description of subsurface conditions be provided on the field logs at the time of drilling. Completing descriptions in the laboratory is not an acceptable practice. Stratification lines should be drawn where two or more items in the description change, i.e., change from firm to stiff and low to high plasticity. Minor variations can be described using the term 'becoming'. A stratification line should be drawn where the geological origin of the material changes and the origin (if determined) should be designated in the material description or remarks column of the log. Dashed lines should be avoided.

The stratigraphy observations should include identification of existing fill, topsoil, and pavement sections. Careful observation and special sampling intervals may be needed to identify the presence and thickness of these strata. The presence of these materials can have a significant impact on the conclusions and recommendations of the geotechnical studies.

Individual strata should be marked midway between samples unless the boundary is encountered in a sample or special measurements are available to better define the position of the boundary.

## 4.5 SAMPLE INFORMATION

Information regarding the sampler types, date & time of sampling, sample type, sample depth, and recovery should be shown on each log form using notations and a graphical system or an abbreviation system as designated in Figures 4-4 and 4-5. Each sample attempt should be given a sequential number marked in the sample number column. If the sampler is driven, the driving resistance should be recorded at the specified intervals and marked in the sampling resistance column. The percent recovery should be designated as the length of the recovered sample referenced to the length of the sample attempt (example 550/610 mm).

## 4.6 SOIL DESCRIPTION AND SOIL CLASSIFICATION

Soil description/identification is the systematic, precise, and complete naming of individual soils in both written and spoken forms (ASTM D-2488, AASHTO M 145), while soil classification is the grouping of the soil with similar engineering properties into a category based on index test results; e.g., group name and symbol (ASTM D-2487, AASHTO M 145). It is important to distinguish between visual identification and classification to minimize conflicts between general visual evaluation of soil samples in the field versus a more precise laboratory evaluation supported by index tests. During progression of a boring, the field personnel should only describe the soils encountered. Group symbols associated with classification should not be used in the field. Visual descriptions in the field is often subjected to outdoor elements, which may influence results. It is important to send the soil samples to a laboratory for accurate visual identification by a technician experienced in soils work, as this single operation will provide the basis for later testing and soil profile development. Classification tests can be performed by the laboratory on representative samples to verify identification and assign appropriate group symbols. If possible, the moisture content of every sample should be performed.

### 4.6.1 Soil Description

The soil's description should include as a minimum:

- C Apparent consistency (for fine-grained soils) or density adjective (for coarse-grained soils)
- C Water content condition adjective (e.g., dry, damp, moist, wet)
- C Color description
- C Minor soil type name with "y" added if fine-grained minor component is less than 30 percent but greater than 12 percent or coarse-grained minor component is 30 percent or more.
- C Descriptive adjective for main soil type
- C Particle-size distribution adjective for gravel and sand
- C Plasticity adjective and soil texture (silty or clayey) for inorganic and organic silts or clays
- C Main soil type name (all capital letters)



- C Descriptive adjective “with” for the fine-grained minor soil type if 5 to 12 percent or for the coarse-grained minor soil type if less than 30 percent but 15 percent or more (note some practices use the descriptive adjectives “some” and “trace” for minor components).
- C Descriptive term for minor type(s) of soil
- C Inclusions (e.g., concretions, cementation)
- C Geological name (e.g., Holocene, Eocene, Pleistocene, Cretaceous), if known, (in parenthesis or in notes column)

The various elements of the soil description should generally be stated in the order given above. For example:

*Fine-grained soils:* Soft, wet, gray, high plasticity CLAY, with f. Sand; (Alluvium)

*Coarse-grained soils:* Dense, moist, brown, silty m-f SAND, with f. Gravel to c. Sand; (Alluvium)

When changes occur within the same soil layer, such as change in apparent density, the log should indicate a description of the change, such as “same, except very dense”.

### **Consistency and Apparent Density**

The consistency of fine-grained soils and apparent density of coarse-grained soils are estimated from the blow count (*N*-value) obtained from Standard Penetration Tests (AASHTO T-206, ASTM D 1586). The consistency of clays and silts varies from soft to firm to stiff to hard. The apparent density of coarse-grained soil ranges from very loose to firm to dense and very dense. Suggested guidelines in Tables 4-1 and 4-2 are given for estimating the in-place consistency or apparent density of soils from *N*-values.

The apparent density or consistency of the soil formation can vary from these empirical correlations for a variety of reasons. Judgment remains an important part of the visual identification process. Mechanical tools such as the pocket (hand) penetrometer, and field index tests (smear test, dried strength test, thread test) are suggested as aids in estimating the consistency of fine grained soils.

In some cases the sampler may pass from one layer into another of markedly different properties; for example, from a dense sand into a soft clay. In attempting to identify apparent density, an assessment should be made as to what part of the blow count corresponds to each layer; realizing that the sampler begins to reflect the presence of the lower layer before it reaches it.

The *N*-values in all soil types should be corrected for energy efficiency, if possible (ASTM D 4633). An energy efficiency of 60% is considered the reference in the U.S. In certain geotechnical evaluations of coarse-grained soil behavior (relative density, friction angle, liquefaction potential), the blow count (*N*-value) should be normalized to a reference stress of one atmosphere, as discussed in Chapters 5 and 9.

**Note that *N*-values should not be used to determine the design strength of fine grained soils.**

### **Water Content (Moisture)**

The amount of water present in the soil sample or its water content adjective should be described as dry, moist, or wet as indicated in Table 4-3.

## Color

The color should be described when the sample is first retrieved at the soil's as-sampled water content (the color will change with water content). Primary colors should be used (brown, gray, black, green, white, yellow, red). Soils with different shades or tints of basic colors are described by using two basic colors; e.g., gray-green. Note that some agencies may require Munsell color and carry no inferences of texture designations. When the soil is marked with spots of color, the term “mottled” can be applied. Soils with a homogeneous texture but having color patterns which change and are not considered mottled can be described as “streaked”.

**TABLE 4-1.**

### EVALUATION OF THE APPARENT DENSITY OF COARSE-GRAINED SOILS

<u>Measured</u> N-value	Apparent Density	Behavior of 13 mm Diameter Probe Rod	Relative Density, %
0 - 4	Very loose	Easily penetrated by hand	0 - 20
> 4 - 10	Loose	Firmly penetrated when pushed by hand	20 - 40
>10 - 30	Firm	Easily penetrated when driven with 2 kg. hammer	40 - 70
>30 - 50	Dense	A few centimeters penetration by 2 kg. hammer	70 - 85
>50	Very Dense	Only a few millimeters penetration when driven with 2 kg. hammer	85 - 100

**TABLE 4-2.**

### EVALUATION OF THE CONSISTENCY OF FINE-GRAINED SOILS

<u>Uncorrected</u> N-value	Consistency	Unconfined Compressive Strength, $q_u$ , kPa	Results Of Manual Manipulation
<2	Very soft	<25	Specimen (height = twice the diameter) sags under its own weight; extrudes between fingers when squeezed.
2 - 4	Soft	25 - 50	Specimen can be pinched in two between the thumb and forefinger; remolded by light finger pressure.
4 - 8	Firm	50 - 100	Can be imprinted easily with fingers; remolded by strong finger pressure.
8 - 15	Stiff	100 - 200	Can be imprinted with considerable pressure from fingers or indented by thumbnail.
15 - 30	Very stiff	200 - 400	Can barely be imprinted by pressure from fingers or indented by thumbnail.
>30	Hard	>400	Cannot be imprinted by fingers or difficult to indent by thumbnail.

**TABLE 4-3.**  
**ADJECTIVES TO DESCRIBE WATER CONTENT OF SOILS**

Description	Conditions
Dry	No sign of water and soil dry to touch
Moist	Signs of water and soil is relatively dry to touch
Wet	Signs of water and soil wet to touch; granular soil exhibits some free water when densified

### **Type of Soil**

The constituent parts of a given soil type are defined on the basis of texture in accordance with particle-size designators separating the soil into coarse-grained, fine-grained, and highly organic designations. Soil with more than 50 percent of the particles larger than the (U.S. Standard) No. 200 sieve (0.075 mm) is designated coarse-grained. Soil (inorganic and organic) with 50 percent or more of the particles finer than the No. 200 sieve is designated fine-grained. Soil primarily consisting of less than 50 percent by volume of organic matter, dark in color, and with an organic odor is designated as organic soil. Soil with organic content more than 50 percent is designated as peat. The soil type designations follow ASTM D 2487; i.e., gravel, sand, clay, silt, organic clay, organic silt, and peat.

#### ***Coarse-Grained Soils (Gravel and Sand)***

Coarse-grained soils consist of gravel, sand, and fine-grained soil, whether separately or in combination, and in which more than 50 percent of the soil is retained on the No. 200 sieve. The gravel and sand components are defined on the basis of particle size as indicated in Table 4-4.

The particle-size distribution is identified as well graded or poorly graded. Well graded coarse-grained soil contains a good representation of all particle sizes from largest to smallest. Poorly graded coarse-grained soil is uniformly graded with most particles about the same size or lacking one or more intermediate sizes.

Gravels and sands may be described by adding particle-size distribution adjectives in front of the soil type following the criteria given in Table 4-5. Based on correlation with laboratory tests, the following simple field identification tests can be used as an aid in identifying granular soils.

Feel and Smear Tests: A pinch of soil is handled lightly between the thumb and fingers to obtain an impression of the grittiness or of the softness of the constituent particles. Thereafter, a pinch of soil is smeared with considerable pressure between the thumb and forefinger to determine the degrees of roughness and grittiness, or the softness and smoothness of the soil. Following guidelines may be used:

- C Coarse- to medium-grained sand typically exhibits a very harsh and gritty feel and smear.
- C Coarse- to fine-grained sand has a less harsh feel, but exhibits a very gritty smear.
- C Medium- to fine-grained sand exhibits a less gritty feel and smear which becomes softer and less gritty with an increase in the fine sand fraction.
- Fine-grained sand exhibits a relatively soft feel and a much less gritty smear than the coarser sand components.
- C Silt components less than about 10 percent of the total weight can be identified by a slight discoloration of the fingers after smear of a moist sample. Increasing silt increases discoloration and softens the smear.

**Sedimentation Test:** A small sample of the soil is shaken in a test tube filled with water and allowed to settle. The time required for the particles to fall a distance of 100 mm is about 1/2 minute for particle sizes coarser than silt. About 50 minutes would be required for particles of .005 mm or smaller (often defined as "clay size") to settle out.

For sands and gravels containing more than 5 percent fines, the type of inorganic fines (silt or clay) can be identified by performing a shaking/dilatancy test. See fine-grained soils section.

**Visual Characteristics:** Sand and gravel particles can be readily identified visually but silt particles are generally indistinguishable to the eye. With an increasing silt component, individual sand grains become obscured, and when silt exceeds about 12 percent, it masks almost entirely the sand component from visual separation. Note that gray fine-grained sand visually appears siltier than the actual silt content.

**TABLE 4-4.**  
**PARTICLE SIZE DEFINITION FOR GRAVELS AND SANDS**

<b>Soil Component</b>	<b>Grain Size</b>	<b>Determination</b>
Boulders*	300 mm +	Measurable
Cobbles*	300 mm to 75 mm	Measurable
Gravel		
Coarse	75 mm to 19 mm	Measurable
Fine	19 mm to #4 sieve (4.75 mm)	Measurable
Sand		
Coarse	#4 to #10 sieve	Measurable and visible to eye
Medium	#10 to #40 sieve	Measurable and visible to eye
Fine	#40 to #200 sieve	Measurable and barely discernible to the eye

\*Boulders and cobbles are not considered soil or part of the soil's classification or description, except under miscellaneous description; i.e., with cobbles at about 5 percent (volume).

**TABLE 4-5.**  
**ADJECTIVES FOR DESCRIBING SIZE DISTRIBUTION FOR SANDS AND GRAVELS**

<b>Particle-Size Adjective</b>	<b>Abbreviation</b>	<b>Size Requirement</b>
Coarse	c.	< 30% m-f sand or < 12% f. gravel
Coarse to medium	c-m	< 12% f. sand
Medium to fine	m-f	< 12% c. sand and > 30% m. sand
Fine	f.	< 30% m. sand or < 12% c. gravel
Coarse to fine	c-f	> 12% of each size <sup>1</sup>

<sup>1</sup> 12% and 30% criteria can be modified depending on fines content. The key is the shape of the particle-size distribution curve. If the curve is relatively straight or dished down, and coarse sand is present, use c-f, also use m-f sand if a moderate amount of m. sand is present. If one has any doubts, determine the above percentages based on the amount of sand or gravel present.

### ***Fine-Grained Soils***

Fine-grained soils are those in which 50 percent or more pass the No. 200 sieve (fines) and the fines are inorganic or organic silts and clays. To describe the fine-grained soil types, plasticity adjectives, and soil types as adjectives should be used to further define the soil type's texture and plasticity. Based on correlations and laboratory tests, the following simple field identification tests can be used to estimate the degree of plasticity of fine-grained soils.

Shaking (Dilatancy) Test: Water is dropped or sprayed on a part of basically fine-grained soil mixed and held in the palm of the hand until it shows a wet surface appearance when shaken or bounced lightly in the hand or a sticky nature when touched. The test involves lightly squeezing the soil pat between the thumb and forefinger and releasing it alternatively to observe its reaction and the speed of the response. Soils which are predominantly silty (nonplastic to low plasticity) will show a dull dry surface upon squeezing and a glassy wet surface immediately upon releasing of the pressure. With increasing fineness (plasticity) and the related decreasing dilatancy, this phenomenon becomes less and less pronounced.

Dry Strength Test: A portion of the sample is allowed to dry out and a fragment of the dried soil is pressed between the fingers. Fragments which cannot be crumbled or broken are characteristic of clays with high plasticity. Fragments which can be disintegrated with gentle finger pressure are characteristic of silty materials of low plasticity. Thus, materials with great dry strength are clays of high plasticity and those with little dry strength are predominantly silts.

Thread Test: (After Burmister, 1970) Moisture is added or worked out of a small ball (about 40 mm diameter) and the ball kneaded until its consistency approaches medium stiff to stiff (compressive strength of about 100 KPa), it breaks, or crumbles. A thread is then rolled out to the smallest diameter possible before disintegration. The smaller the thread achieved, the higher the plasticity of the soil. Fine-grained soils of high plasticity will have threads smaller than 3/4 mm in diameter. Soils with low plasticity will have threads larger than 3 mm in diameter.

Smear Test: A fragment of soil smeared between the thumb and forefinger or drawn across the thumbnail will, by the smoothness and sheen of the smear surface, indicate the plasticity of the soil. A soil of low plasticity will exhibit a rough textured, dull smear while a soil of high plasticity will exhibit a slick, waxy smear surface.

Table 4-6 identifies field methods to approximate the plasticity range for the dry strength, thread, and smear tests.

### **Highly Organic Soils**

Colloidal and amorphous organic materials finer than the No. 200 sieve are identified and classified in accordance with their drop in plasticity upon oven drying (ASTM D 2487). Additional identification markers are:

1. dark gray and black and sometimes dark brown colors, although not all dark colored soils are organic;
2. most organic soils will oxidize when exposed to air and change from a dark gray/black color to a lighter brown; i.e., the exposed surface is brownish, but when the sample is pulled apart the freshly exposed surface is dark gray/black;

TABLE 4-6.

FIELD METHODS TO DESCRIBE PLASTICITY

Plasticity Range	Adjective	Dry Strength	Smear Test	Thread Smallest Diameter, mm
0	nonplastic	none - crumbles into powder with mere pressure	gritty or rough	ball cracks
1 - 10	low plasticity	low - crumbles into powder with some finger pressure	rough to smooth	6 to 3
>10 - 20	medium plasticity	medium - breaks into pieces or crumbles with considerable finger pressure	smooth and dull	1-1/2
>20 - 40	high plasticity	high - cannot be broken with finger pressure; spec. will break into pieces between thumb and a hard surface	shiny	3/4
>40	very plastic	very high - can't be broken between thumb and a hard surface	very shiny and waxy	1/2

3. fresh organic soils usually have a characteristic odor which can be recognized, particularly when the soil is heated;
4. compared to non-organic soils, less effort is typically required to pull the material apart and a friable break is usually formed with a fine granular or silty texture and appearance;
5. their workability at the plastic limit is weaker and spongier than an equivalent non-organic soil;
6. the smear, although generally smooth, is usually duller and appears more silty; and
7. the organic content of these soils can also be determined by combustion test method (AASHTO T 267, ASTM D 2974).

Fine-grained soils, where the organic content appears to be less than 50 percent of the volume (about 22 percent by weight) should be described as soils with organic material or as organic soils such as clay with organic material or organic clays etc. If the soil appears to have an organic content higher than 50 percent by volume it should be described as peat. The engineering behavior of soils below and above the 50 percent dividing line presented here is entirely different. It is therefore critical that the organic content of soils be determined both in the field and in the laboratory (AASHTO T 267, ASTM D 2974). Simple field or visual laboratory identification of soils as organic or peat is neither advisable nor acceptable.

It is very important not to confuse topsoil with organic soils or peat. Topsoil is the thin layer of deposit found on the surface composed of partially decomposed organic materials, such as leaves, grass, small roots etc. It contains many nutrients that sustain plant and insect life. These should not be classified as organic soils or peat and should not be used in engineered structures.

## Minor Soil Type(s)

In many soil formations, two or more soil types are present. When the percentage of the fine-grained minor soil type is less than 30 percent but greater than 12 percent of the total sample or the coarse-grained minor component is 30 percent or more of the total sample, the minor soil type is indicated by adding a "y" to its name (i.e., f. gravelly, c-f. sandy, silty, clayey, organic). Note the gradation adjectives are given for granular soils, while the plasticity adjective is omitted for the fine-grained soils.)

When the percentage of the fine-grained minor soil type is 5 to 12 percent or for the coarse-grained minor soil type is less than 30 percent but 15 percent or more of the total sample, the minor soil type is indicated by adding the descriptive adjective "with" to the group name (i.e., with clay, with silt, with sand, with gravel, and/or with cobbles ).

Some local practices use the descriptive adjectives "some" and "trace" for minor components.

- C "trace" when the percentage is between 1 and 12 percent of the total sample; or
- C "some" when the percentage is greater than 12 percent and less than 30 percent of the total sample.

## Inclusions

Additional inclusions or characteristics of the sample can be described by using "with" and the descriptions described above. Examples are given below:

- C with petroleum odor
- C with organic matter
- C with foreign matter (roots, brick, etc.)
- C with shell fragments
- C with mica
- C with parting(s), seam(s), etc. of (give soils complete description)

## Layered Soils

Soils of different types can be found in repeating layers of various thickness. It is important that all such formations and their thicknesses are noted. Each layer is described as if it is a nonlayered soil using the sequence for soil descriptions discussed above. The thickness and shape of layers and the geological type of layering are noted using the descriptive terms presented in Table 4-7. Place the thickness designation before the type of layer, or at the end of each description and in parentheses, whichever is more appropriate.

Examples of descriptions for layered soils are:

- C Medium stiff, moist to wet 5 to 20 mm interbedded seams and layers of: gray, medium plastic, silty CLAY; and lt. gray, low plasticity SILT; (Alluvium).
- C Soft moist to wet varved layers of: gray-brown, high plasticity CLAY (5 to 20 mm); and nonplastic SILT, trace f. sand (10 to 15 mm); (Alluvium).

**TABLE 4-7.**

**DESCRIPTIVE TERMS FOR LAYERED SOILS**

Type Of Layer	Thickness	Occurrence
Parting	< 1.5 mm	
Seam	10 to 1.5 mm	
Layer	300 to 10 mm	
Stratum	>300 mm	
Pocket		Small erratic deposit
Lens		Lenticular deposit
Varved (also layered)		Alternating seams or layers of silt and/or clay and sometimes fine sand
Occasional		One or less per 0.3 m of thickness or laboratory sample inspected
Frequent		More than one per 0.3 m of thickness or laboratory

**Geological Name**

The soil description should include the field supervisor’s assessment of the origin of the soil unit and the geologic name, if known, placed in parentheses or brackets at the end of the soil description or in the field notes column of the boring log. Some examples include:

- a. *Washington, D.C.* - Cretaceous Age Material with SPT-N values between 30 and 100 bpf:  
Very hard gray-blue silty CLAY (CH), damp [**Potomac Group Formation**]
- b. *Newport News, VA* - Miocene Age Marine Deposit with SPT- N values around 10 to 15 bpf:  
Stiff green sandy CLAY (CL) with shell fragments, calcareous [**Yorktown Formation**].

**4.6.2 Soil Classification**

As previously indicated, final identification with classification is best performed in the laboratory. This will lead to more consistent final boring logs and avoid conflicts with field descriptions. The Unified Soil Classification System (USCS) Group Name and Symbol (in parenthesis) appropriate for the soil type in accordance with AASHTO M 145, ASTM D 3282, or ASTM D 2487 is the most commonly used system in geotechnical work and is covered in this section. For classification of highway subgrade material, the AASHTO classification system (see Section 4.6.3) is used and is also based on grain size and plasticity.

***The Unified Classification System***

The Unified Classification System (ASTM D 2487) groups soils with similar engineering properties into categories base on grain size, gradation and plasticity. Table 4-8 provides a simplification of the group breakdown and Table 4-9 provides an outline of the complete laboratory classification method. Following are the procedures along with charts and tables for classifying coarse-grained and fine-grained soils.

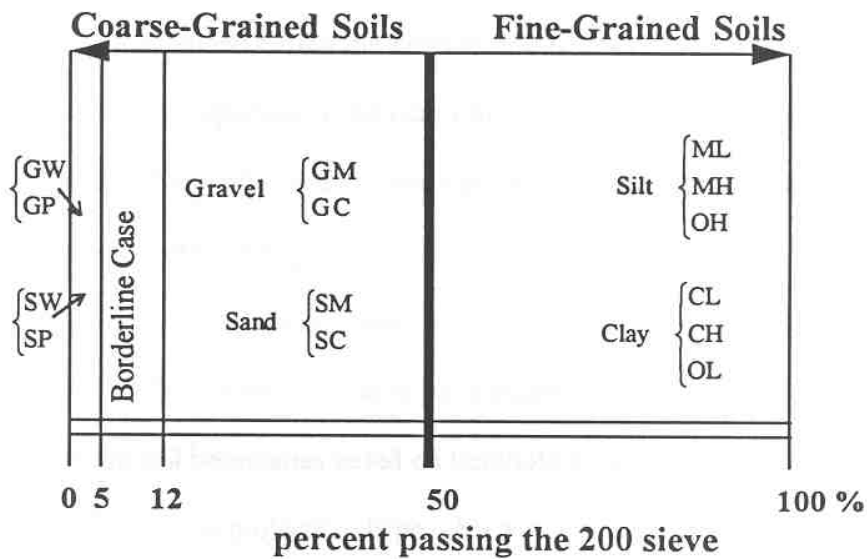


**Classification of Coarse-Grained Soils**

The flow chart to determine the group symbol and group name for coarse-grained soils, those in which 50 percent or more are retained on the No. 200 sieve (0.075 mm) is given in Figure 4-6. This figure is identical to that of Figure 2 in ASTM D 2487 except for the recommendation to capitalize the primary soil type; i.e., GRAVEL.

**TABLE 4-8.**

**THE UNIFIED CLASSIFICATION SYSTEM**



**Soil Type:** G = Gravel      S = Sand      M = Silt  
 C = Clay              O = Organics

**Soil Gradation:** determined on dis-aggregated specimen forced through nested sieves  
 W = Well Graded      P = Poorly Graded  
 $C_u > 4$  (GW) to  $6$  (SW)       $C_u < 4$  (GP) to  $6$  (SP)

**Plasticity:** determined on remolded specimens  
 H = High Plasticity      L = Low Plasticity  
 $LL > 50$                    $LL < 50$

TABLE 4-9.

SOIL CLASSIFICATION CHART (LABORATORY METHOD)

Criteria for Assigning Group Symbols and Group Names Using Laboratory Tests <sup>a</sup>			Soil Classification	
			Group Symbol	Group Name <sup>b</sup>
GRAVELS  More than 50% of coarse Fraction retained on No. 4 Sieve	CLEAN GRAVELS	$C_U \leq 4$ and $1 \leq C_C \leq 3^e$	GW	Well-graded Gravel
	Less than 5% fines	$C_U \leq 4$ and $1 \leq C_C \leq 3^e$	GP	Poorly-graded Gravel <sup>f</sup>
	GRAVELS WITH FINES	Fines classify as ML or MH	GM	Silty Gravel <sup>f,g,h</sup>
	More than 12% of fines <sup>c</sup>	Fines classify as CL or CH	GC	Clayey Gravel <sup>f,g,h</sup>
SANDS  50% or more of coarse Fraction retained on No. 4 Sieve	CLEAN SANDS	$C_U \leq 6$ and $1 \leq C_C \leq 3^e$	SW	Well-graded Sand <sup>i</sup>
	Less than 5% fines <sup>d</sup>	$C_U \leq 6$ and $1 \leq C_C \leq 3^e$	SP	Poorly-graded Sand <sup>i</sup>
	SANDS WITH FINES	Fines classify as ML or MH	SM	Silty Sand <sup>g,h,i</sup>
	More than 12% fines <sup>d</sup>	Fines classify as CL or CH	SC	Clayey Sand <sup>g,h,i</sup>
SILTS AND CLAYS  Liquid limit less than 50%	Inorganic	PI > 7 and plots on or above "A" line <sup>j</sup>	CL	Lean Clay <sup>k,l,m</sup>
		PI < 4 or plots below "A" line <sup>j</sup>	ML	Silt <sup>k,l,m</sup>
	Organic	$\frac{\text{Liquid limit - oven dried}}{\text{Liquid limit - not dried}} < 0.75$	OL	Organic Clay <sup>k,l,m,n</sup> Organic Silt <sup>k,l,m,o</sup>
SILTS AND CLAYS  Liquid limit more than 50%	Inorganic	PI plots on or above "A" line	CH	Fat Clay <sup>k,l,m</sup>
		PI plots below "A" line	MH	Elastic Silt <sup>k,l,m</sup>
	Organic	$\frac{\text{Liquid limit - oven dried}}{\text{Liquid limit - not dried}} < 0.75$	OH	Organic Silt <sup>k,l,m,p</sup> Organic Silt <sup>k,l,m,q</sup>
Highly fibrous organic soils	Primary organic matter, dark in color, and organic odor		Pt	Peat and Muskeg

**TABLE 4-9. (Continued)**  
**SOIL CLASSIFICATION CHART (LABORATORY METHOD)**

NOTES:

- a Based on the material passing the 75-mm sieve.
- b If field sample contained cobbles and/or boulders, add “with cobbles and/or boulders” to group name.
- c Gravels with 5 to 12% fines require dual symbols:  
 GW-GM well-graded gravel with silt  
 GW-GC well-graded gravel with clay  
 GP-GM poorly graded gravel with silt  
 GP-GC poorly graded gravel with clay
- d Sands with 5 to 12% fines require dual symbols:  
 SW-SM well-graded sand with silt  
 SW-SC well-graded sand with clay  
 SP-SM poorly graded sand with silt  
 SP-SC poorly graded sand with clay
- e 
$$C_U = \frac{D_{60}}{D_{10}} = \text{Uniformity Coefficient (also UC)}$$
- $$C_C = \frac{(D_{30})^2}{(D_{10})(D_{60})} = \text{Coefficient of Curvature}$$
- f If soil contains \$ 15% sand, add “with sand” to group name.
- g If fines classify as CL-ML, use dual symbol GC-GM, SC-SM.
- h If fines are organic, add “with organic fines” to group name.
- i If soil contains \$ 15% gravel, add “with gravel” to group name.
- j If the liquid limit and plasticity index plot in hatched area on plasticity chart, soil is a CL-ML, silty clay.
- k If soil contains 15 to 29% plus No. 200, add “with sand” or “with gravel”, whichever is predominant.
- l If soil contains \$ 30% plus No. 200, predominantly sand, add “sandy” to group name.
- m If soil contains \$ 30% plus No. 200, predominantly gravel, add “gravelly” to group name.
- n PI \$ 4 and plots on or above “A” line.
- o PI < 4 or plots below “A” line.
- p PI plots on or above “A” line.
- q PI plots below “A” line.

---

**FINE-GRAINED SOILS** (clays & silts): 50% or more passes the No. 200 sieve

---

**COARSE-GRAINED SOILS** (sands & gravels): more than 50% retained on No. 200 sieve

---

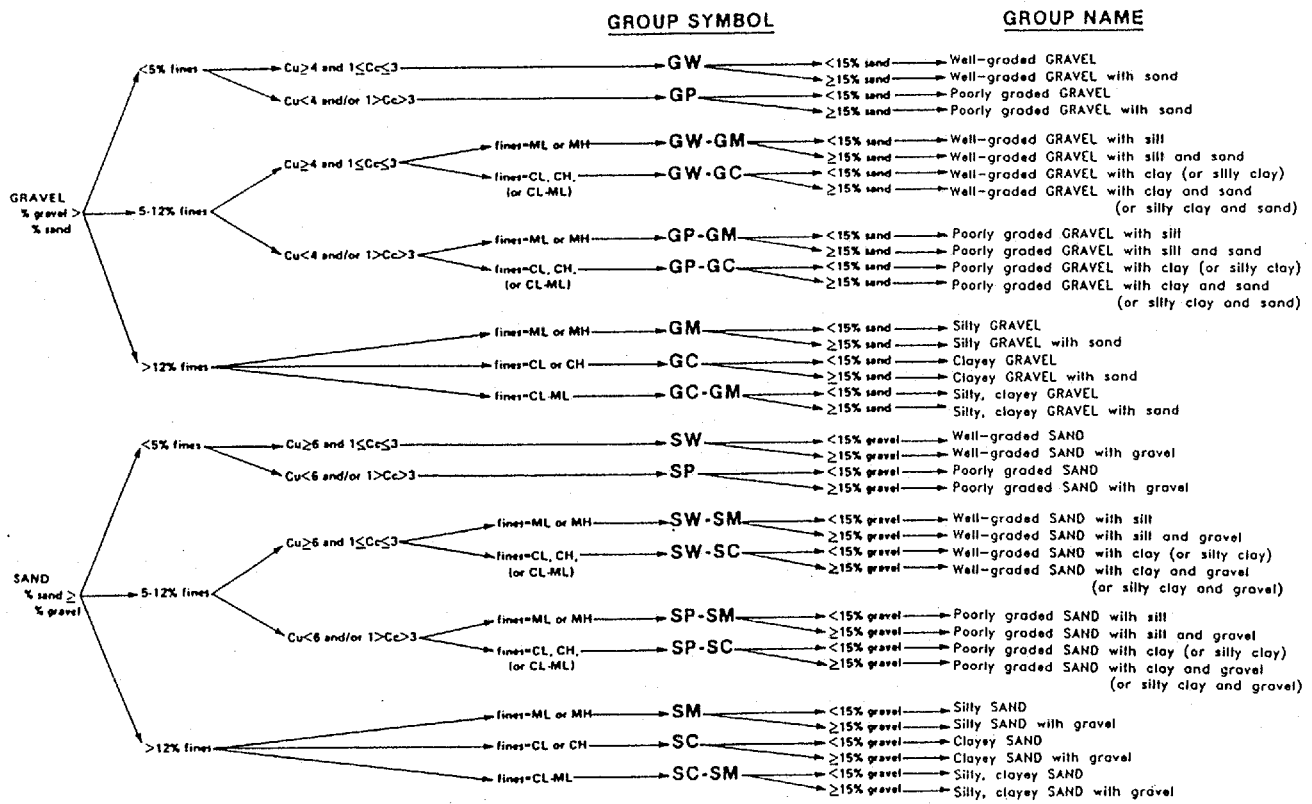


Figure 4-6. Flow Chart to Determine the Group Symbol and Group Name for Coarse-grained Soils. (From U.S. Bureau of Reclamation Soil Classification Handbook, 1960)

### Classification of Fine-Grained Soils

Fine-grained soils, those in which 50 percent or more pass the No. 200 sieve (fines), are defined by the plasticity chart (Figure 4-7) and, for organic soils, the decrease in liquid limit (LL) upon oven drying (Table 4-9). Inorganic silts and clays are those which do not meet the organic criteria as given in Table 4-9. The flow charts to determine the group symbol and group name for fine-grained soils are given in Figure 4-8a and b. These figures are identical to Figures 1a and 1b in ASTM D 2487 except that they are modified to show the soil type capitalized; i.e., CLAY. Dual symbols are used to indicate the organic silts and clays that are above the "A"-line. For example, CL/OL instead of OL and CH/OH instead of OH. To describe the fine-grained soil types, plasticity adjectives, and soil types as adjectives should be used to further define the soil type's texture, plasticity, and location on the plasticity chart; see Table 4-10. Examples using Table 4-10 are given in Table 4-11.

As an example, the group name and symbol has been added to the example descriptions given in the previous section:

*Fine-grained soils:* Soft, wet, gray, high plasticity CLAY, with f. Sand; Fat CLAY (CH); (Alluvium)

*Coarse-grained soils:* Dense, moist, brown, silty m-f SAND, with f. Gravel to c. Sand; Silty SAND (SM); (Alluvium)

Some local practices omit the USCS group symbol (e.g., CL, ML, etc.) but include the group symbol at the end of the description.

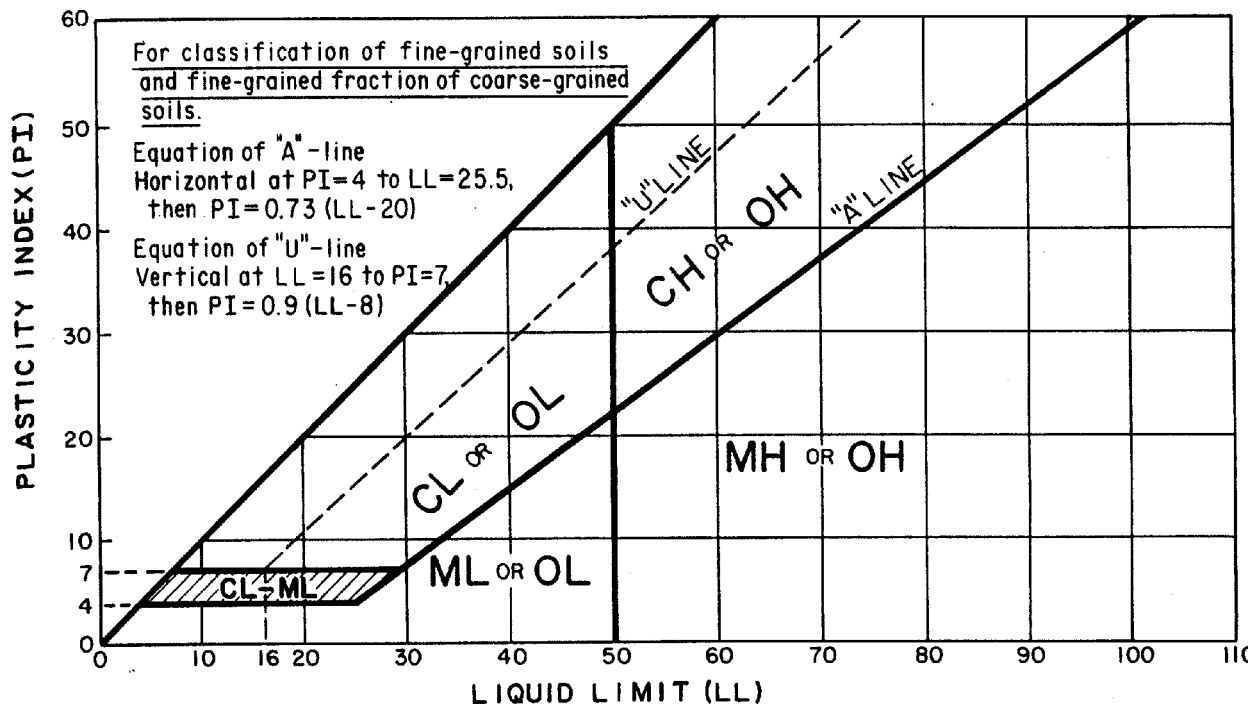


Figure 4-7. Plasticity Chart for Unified Soil Classification System (ASTM D 2488).

**TABLE 4-10.**

**SOIL PLASTICITY DESCRIPTIONS**

Plasticity Index Range	Plasticity Adjective	Adjective for Soil Type, Texture, and Plasticity Chart Location		
		ML & MH (Silt)	CL & CH (Clay)	OL & OH (Organic Silt or Clay) <sup>1</sup>
0	nonplastic	-	-	ORGANIC SILT
1 - 10	low plasticity	-	silty	ORGANIC SILT
>10 - 20	medium plasticity	clayey	silty to no adj.	ORGANIC clayey SILT
>20 - 40	high plasticity	clayey	-	ORGANIC silty CLAY
>40	very plastic	clayey	-	ORGANIC CLAY

<sup>1</sup> Soil type is the same for above or below the “A”-line; the dual group symbol (CL/OL or CH/OH) identifies the soil types above the “A”-line.

**TABLE 4-11.**

**EXAMPLES OF DESCRIPTION OF FINE-GRAINED SOILS**

Group Symbol	PI	Group Name	Complete Description For Main Soil Type (Fine-Grained Soil)
CL	9	lean CLAY	low plasticity silty CLAY
ML	7	SILT	low plasticity SILT
ML	15	SILT	medium plastic clayey SILT
MH	21	elastic SILT	high plasticity clayey SILT
CH	25	fat CLAY	high plasticity silty CLAY or high plasticity CLAY, depending on smear test (for silty relatively dull and not shiny or just CLAY for shiny, waxy)
OL	8	ORGANIC SILT	low plasticity ORGANIC SILT
OL	19	ORGANIC SILT	medium plastic ORGANIC clayey SILT
CH	>40	fat CLAY	very plastic CLAY

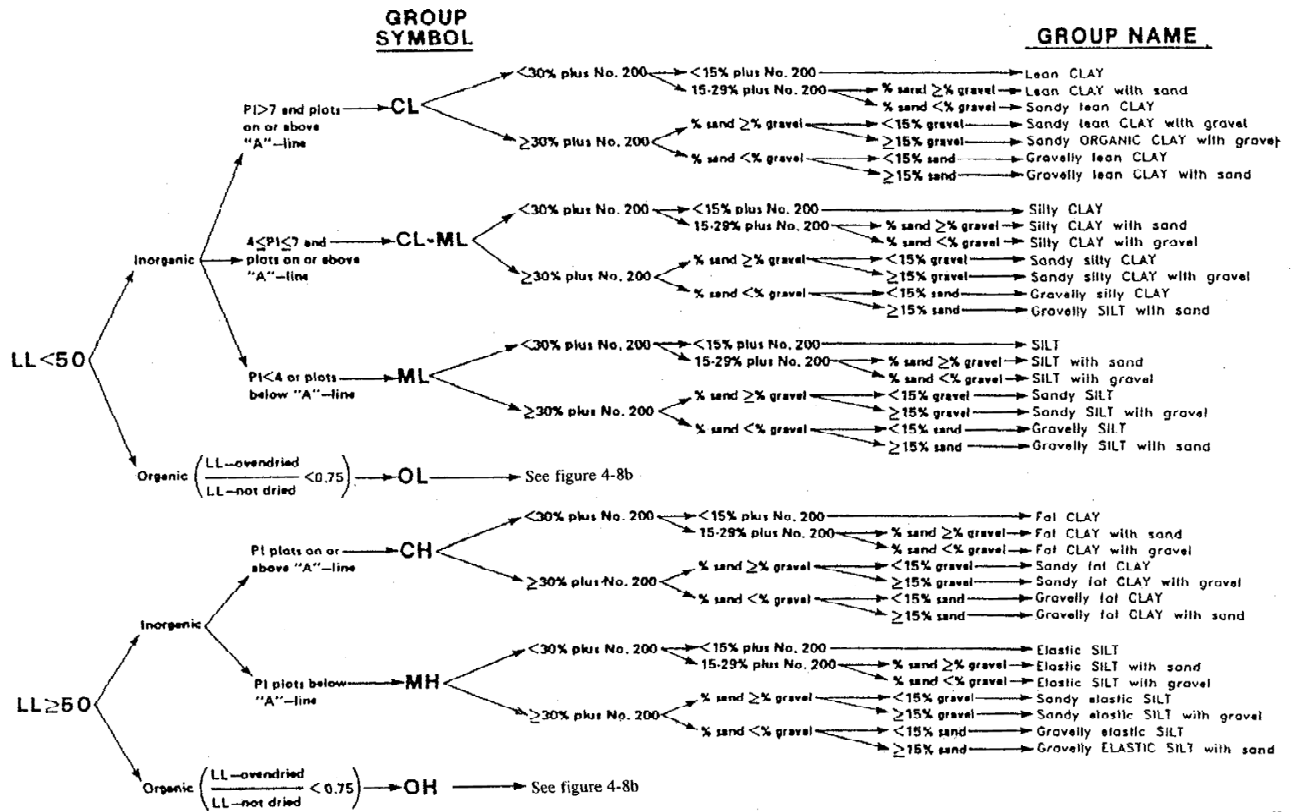


Figure 4-8a. Flow Chart to Determine the Group Symbol and Group Name for Fine-Grained Soils.

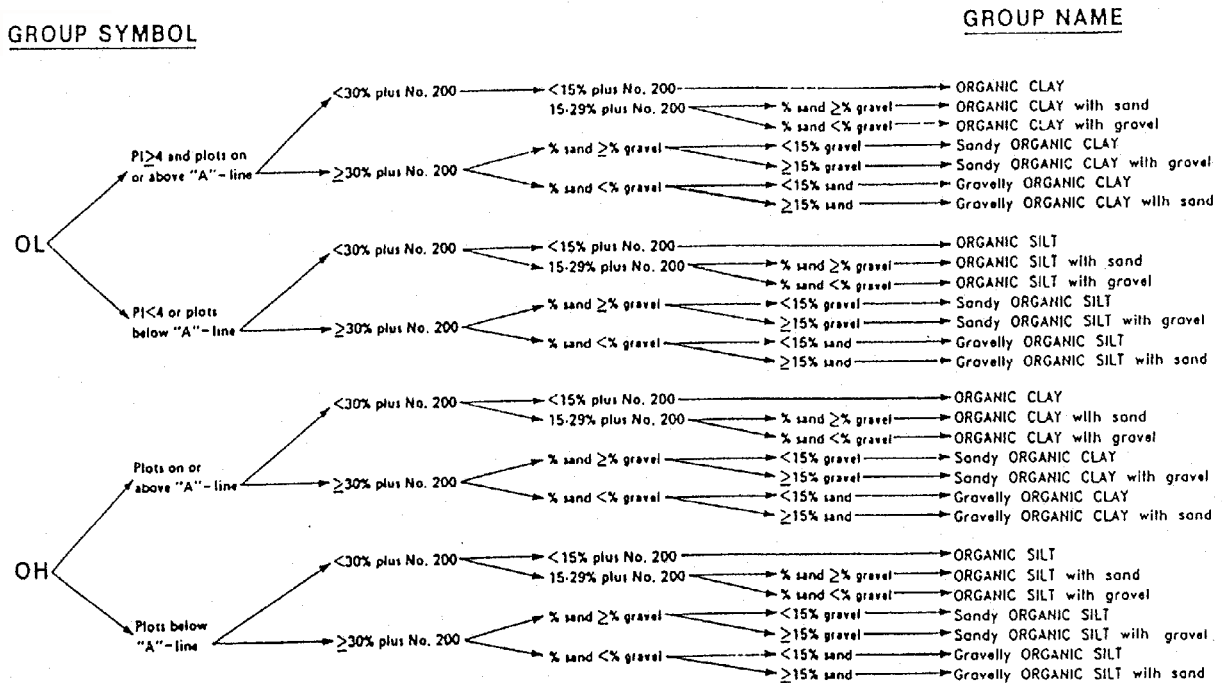


Figure 4-8b. Flow Chart to Determine the Group Symbol and Group Name for Organic Soils.

### 4.6.3 AASHTO Soil Classification System

The AASHTO soil classification system is shown in Table 4-12. This classification system is useful in determining the relative quality of the soil material for use in earthwork structures, particularly embankments, subgrades, subbases and bases.

According to this system, soil is classified into seven major groups, A-1 through A-7. Soils classified under groups A-1, A-2 and A-3 are granular materials where 35% or less of the particles pass through the No. 200 sieve. Soils where more than 35% pass the No. 200 sieve are classified under groups A-4, A-5, A-6 and A-7. These are mostly silt and clay-type materials. The classification procedure is shown in Table 4-12. The classification system is based on the following criteria:

- I. *Grain Size*: The grain size terminology for this classification system is as follows:  
Gravel: fraction passing the 75 mm sieve and retained on the No. 10 (2 mm) sieve.  
Sand: fraction passing the No. 10 (2 mm) sieve and retained on the No. 200 (0.075 mm) sieve  
Silt and clay: fraction passing the No. 200 (0.075 mm) sieve
- ii *Plasticity*: The term *silty* is applied when the fine fractions of the soil have a plasticity index of 10 or less. The term *clayey* is applied when the fine fractions have a plasticity index of 11 or more.
- iii. If cobbles and boulders (size larger than 75 mm) are encountered they are excluded from the portion of the soil sample on which classification is made. However, the percentage of material is recorded.

To evaluate the quality of a soil as a highway subgrade material, a number called the *group index* (GI) is also incorporated along with the groups and subgroups of the soil. This is written in parenthesis after the group or subgroup designation. The group index is given by the equation

$$\text{Group Index: } GI = (F - 35)[0.2 + 0.005(LL - 40)] + 0.01(F - 15)(PI - 10) \quad (4-1)$$

where F is the percent passing No. 200 sieve, LL is the liquid limit and PI is the plasticity index. The first term of Eq. 4-1 is the partial group index determined from the liquid limit. The second term is the partial group index determined from the plasticity index. Following are some rules for determining group index:

- C If Eq. 4-1 yields a negative value for GI, it is taken as zero.
- C The group index calculated from Eq. 4-1 is rounded off to the nearest whole number, e.g., GI=3.4 is rounded off to 3; GI=3.5 is rounded off to 4.
- C There is no upper limit for the group index.
- C The group index of soils belonging to groups A-1-a, A-1-b, A-2-4, A-2-5, and A-3 will always be zero.
- C When calculating the group index for soils belonging to groups A-2-6 and A-2-7, the partial group index for PI should be used, or

$$GI = 0.01(F - 15)(PI - 10) \quad (4-2)$$

In general, the quality of performance of a soil as a subgrade material is inversely proportional to the group index.



**TABLE 4-12.**  
**AASHTO SOIL CLASSIFICATION SYSTEM (AASHTO M 145, 1995)**

GENERAL CLASSIFICATION	GRANULAR MATERIALS (35 percent or less of total sample passing No. 200)					SILT-CLAY MATERIALS (More than 35 percent of total sample passing No. 200)				
	A-1		A-3	A-2			A-4	A-5	A-6	A-7
GROUP CLASSIFICATION	A-1-a	A-1-b		A-2-4	A-2-5	A-2-6				
Sieve analysis, percent passing: 2 mm (No. 10) 0.425 mm (No. 40) 0.075 mm (No. 200)	50 max. 30 max. 15 max.	50 max. 25 max.	51 min. 10 max.	35 max.	35 max.	35 max.	36 min.	36 min.	36 min.	A-7 A-7-5, A-7-6
Characteristics of fraction passing 0.425 mm (No. 40) Liquid limit Plasticity index	6 max.		NP				40 max. 10 max.	41 min. 10 max.	40 max. 11 min.	41 min. 10 max. 11 min.*
Usual significant constituent materials	Stone fragments, gravel and sand		Fine sand	Silty or clayey gravel and sand			Silty soils		Clayey soils	
Group Index**	0	0	0	0	4 max.	8 max.	12 max.	16 max.	20 max.	

Classification procedure: With required test data available, proceed from left to right on chart; correct group will be found by process of elimination. The first group from left into which the test data will fit is the correct classification.

\*Plasticity Index of A-7-5 subgroup is equal to or less than LL minus 30. Plasticity Index of A-7-6 subgroup is greater than LL minus 30 (see Fig 4-9).

\*\*See group index formula (Eq. 4-1) Group index should be shown in parentheses after group symbol as: A-2-6(3), A-4(5), A-6(12), A-7-5(17), etc.

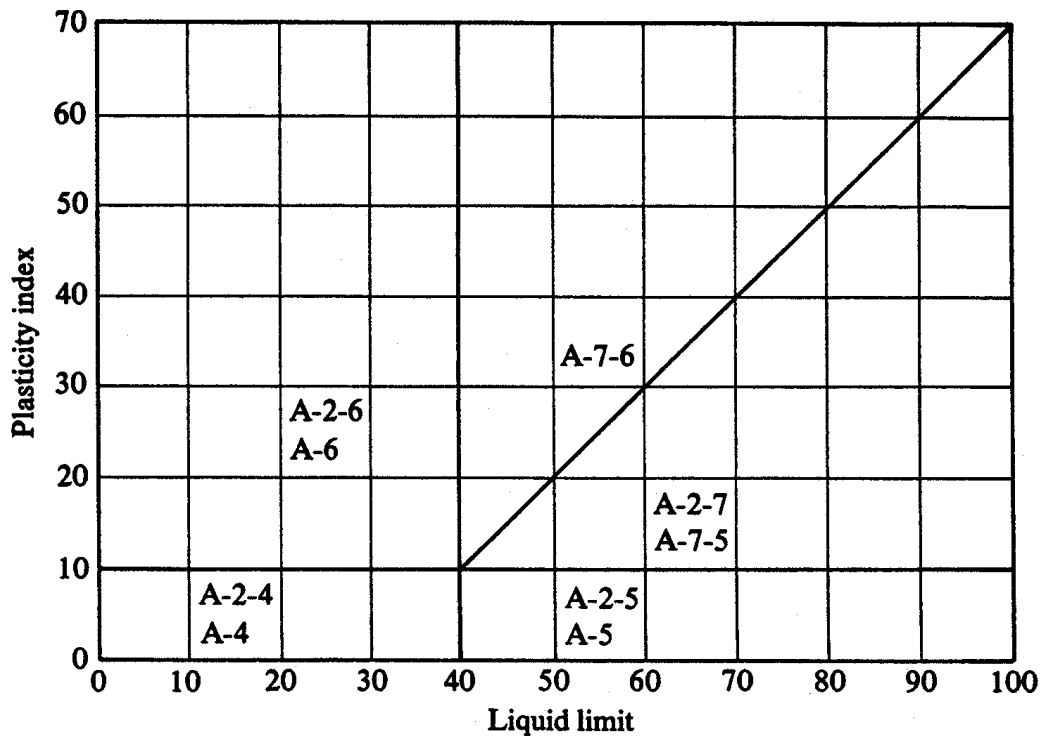


Figure 4-9. Range of Liquid Limit and Plasticity Indices for Soils in Soil Classification Groups A-2, A-4, A-5, A-6 and A-7 (AASHTO Standard M 145, 1995).

#### 4.7 LOGGING PROCEDURES FOR CORE DRILLING

As with soil boring logs, rock or core boring logs should be as comprehensive as possible under field conditions, yet be terse and precise. The level of detail should be keyed to the purpose of the exploration as well as to the intended user of the prepared logs. Although the same basic information should be presented on all rock boring logs, the appropriate level of detail should be determined by the geotechnical engineer and/or the geologist based on project needs. Borings for a bridge foundation may require more detail concerning degree of weathering than rock structure features. For a proposed tunnel excavation, the opposite might be true. Extremely detailed descriptions of rock mineralogy may mask features significant to an engineer, but may be critical for a geologist.

##### 4.7.1 Description of Rock

Rock descriptions should use technically correct geological terms, although local terms in common use may be acceptable if they help describe distinctive characteristics. Rock cores should be logged when wet for consistency of color description and greater visibility of rock features. The guidelines presented in the "International Society for Rock Mechanics Commission on Standardization of Laboratory and Field Tests" (1978, 1981), should be reviewed for additional information regarding logging procedures for core drilling.

The rock's lithologic description should include as a minimum the following items:

- C Rock type
- C Color
- C Grain size and shape
- C Texture (stratification/foliation)
- C Mineral composition
- C Weathering and alteration
- C Strength
- C Other relevant notes

The various elements of the rock's description should be stated in the order listed above. For example:

"Limestone, light gray, very fine-grained, thin-bedded, unweathered, strong"

The rock description should include identification of discontinuities and fractures. The description should include a drawing of the naturally occurring fractures and mechanical breaks.

#### **4.7.2 Rock Type**

Rocks are classified according to origin into three major divisions: igneous, sedimentary, and metamorphic, see Table 4-13. These three groups are subdivided into types according to mineral and chemical composition, texture, and internal structure. For some projects a library of hand samples and photographs representing lithologic rock types present in the project area should be maintained.

#### **4.7.3 Color**

Colors should be consistent with a Munsell Color Chart and recorded for both wet and dry conditions as appropriate.

#### **4.7.4 Grain Size and Shape**

The grain size description should be classified using the terms presented in Table 4-14. Table 4-15 is used to further classify the shape of the grains.

#### **4.7.5 Stratification/Foliation**

Significant nonfracture structural features should be described. The thickness should be described using the terms in Table 4-16. The orientation of the bedding/foliation should be measured from the horizontal with a protractor.

TABLE 4-13.

ROCK GROUPS AND TYPES

<b>IGNEOUS</b>		
<i>Intrusive (Coarse Grained)</i>	<i>Extrusive (Fine Grained)</i>	<i>Pyroclastic</i>
Granite Syenite Diorite Diabase Gabbro Peridotite Pegmatite	Rhyolite Trachyte Andesite Basalt	Obsidian Pumice Tuff
<b>SEDIMENTARY</b>		
<i>Clastic (Sediment)</i>	<i>Chemically Formed</i>	<i>Organic Remains</i>
Shale Mudstone Claystone Siltstone Sandstone Conglomerate Limestone, oolitic	Limestone Dolomite Gypsum Halite	Chalk Coquina Lignite Coal
<b>METAMORPHIC</b>		
<i>Foliated</i>	<i>Nonfoliated</i>	
Slate Phyllite Schist Gneiss	Quartzite Amphibolite Marble Hornfels	

**TABLE 4-14.****TERMS TO DESCRIBE GRAIN SIZE OF (TYPICALLY FOR) SEDIMENTARY ROCKS**

Description	Diameter (mm)	Characteristic
Very coarse grained	> 4.75	Grains sizes are greater than popcorn kernels
Coarse grained	2.00 -4.75	Individual grains can be easily distinguished by eye
Medium grained	0.425 -2.00	Individual grains can be distinguished by eye
Fine grained	0.075-0.425	Individual size grains can be distinguished with difficulty
Very fine grained	< 0.075	Individual grains cannot be distinguished by unaided eye

**TABLE 4-15.****TERMS TO DESCRIBE GRAIN SHAPE (FOR SEDIMENTARY ROCKS)**

Description	Characteristic
Angular	Showing very little evidence of wear. Grain edges and corners are sharp. Secondary corners are numerous and sharp.
Subangular	Showing definite effects of wear. Grain edges and corners are slightly rounded off. Secondary corners are slightly less numerous and slightly less sharp than in angular grains.
Subrounded	Showing considerable wear. Grain edges and corners are rounded to smooth curves. Secondary corners are reduced greatly in number and highly rounded.
Rounded	Showing extreme wear. Grain edges and corners are smoothed off to broad curves. Secondary corners are few in number and rounded.
Well-rounded	Completely worn. Grain edges or corners are not present. No secondary edges or corners are present.

**TABLE 4-16.****TERMS TO DESCRIBE STRATUM THICKNESS**

Descriptive Term	Stratum Thickness
Very Thickly bedded	> 1 m
Thickly bedded	0.5 to 1.0 m
Thinly bedded	50 mm to 500 mm
Very Thinly bedded	10 mm to 50 mm
Laminated	2.5 mm to 10 mm
Thinly Laminated	< 2.5 mm

#### 4.7.6 Mineral Composition

The mineral composition should be identified by a geologist based on experience and the use of appropriate references. The most abundant mineral should be listed first, followed by minerals in decreasing order of abundance. For some common rock types, mineral composition need not be specified (e.g. dolomite, limestone).

#### 4.7.7 Weathering and Alteration

Weathering as defined here is due to physical disintegration of the minerals in the rock by atmospheric processes while alteration is defined here as due to geothermal processes. Terms and abbreviations used to describe weathering or alteration are presented in Figure 4-5.

#### 4.7.8 Strength

The point load test, described in Section 8.2.1, is recommended for the measurement of sample strength in the field. The point-load index ( $I_p$ ) may be converted to an equivalent uniaxial compressive strength and noted as such on the records. Various categories and terminology recommended for describing rock strength based on the point load test are presented in Figure 4-5. Figure 4-5 also presents guidelines for common qualitative assessment of strength while mapping or during primary logging of core at the rig site by using a geological hammer and pocket knife. The field estimates should be confirmed where appropriate by comparison with selected laboratory tests.

#### 4.7.9 Hardness

Hardness is commonly assessed by the scratch test. Descriptions and abbreviations used to describe rock hardness are presented in Table 4-17.

TABLE 4-17.

### TERMS TO DESCRIBE ROCK HARDNESS

Description (Abbr)	Characteristic
Soft (S)	Reserved for plastic material alone.
Friable (F)	Easily crumbled by hand, pulverized or reduced to powder and is too soft to be cut with a pocket knife.
Low Hardness (LH)	Can be gouged deeply or carved with a pocket knife.
Moderately Hard (MH)	Can be readily scratched by a knife blade; scratch leaves a heavy trace of dust and scratch is readily visible after the powder has been blown away.
Hard (H)	Can be scratched with difficulty; scratch produces little powder and is often faintly visible; traces of the knife steel may be visible.
Very Hard (VH)	Cannot be scratched with pocket knife. Leave knife steel marks on surface.

#### 4.7.10 Rock Discontinuity

Discontinuity is the general term for any mechanical crack or fissure in a rock mass having zero or low tensile strength. It is the collective term for most types of joints, weak bedding planes, weak schistosity planes, weakness zones, and faults. The symbols recommended for the type of rock mass discontinuities are listed in Figure 4-5.

The spacing of discontinuities is the perpendicular distance between adjacent discontinuities. The spacing should be measured in centimeters or millimeters, perpendicular to the planes in the set. Figure 4-5 presents guidelines to describe discontinuity spacing.

The discontinuities should be described as closed, open, or filled. Aperture is used to describe the perpendicular distance separating the adjacent rock walls of an open discontinuity in which the intervening space is air or water filled. Width is used to describe the distance separating the adjacent rock walls of filled discontinuities. The terms presented in Table 4-18 should be used to describe apertures.

Terms such as "wide", "narrow" and "tight" are used to describe the width of discontinuities such as thickness of veins, fault gouge filling, or joints openings. Guidelines for use of such terms are presented in Figure 4-5.

For the faults or shears that are not thick enough to be represented on the boring log, the measured thickness is recorded numerically in millimeters.

In addition to the above characterization, discontinuities are further characterized by the surface shape of the joint and the roughness of its surface. Refer to Figure 4-5 for guidelines to characterize these features.

Filling is the term for material separating the adjacent rock walls of discontinuities. Filling is characterized by its type, amount, width (i.e., perpendicular distance between adjacent rock walls) and strength. Figure 4-5 presents guidelines for characterizing the amount and width of filling. The strength of any filling material along discontinuity surfaces can be assessed by the guidelines for soil presented in the last three columns of Table 4-2. For non-cohesive fillings, then identify the filling qualitatively (e.g., fine sand).

**TABLE 4-18.**  
**TERMS TO CLASSIFY DISCONTINUITIES BASED ON APERTURE SIZE**

Aperture	Description	
<0.1 mm 0.1 - 0.25 mm 0.25 - 0.5 mm	Very tight Tight Partly open	"Closed Features"
0.5 - 2.5 mm 2.5 - 10 mm > 10 mm	Open Moderately open Wide	"Gapped Features"
1-10 cm 10-100 cm >1 m	Very wide Extremely wide Cavernous	"Open Features"

#### 4.7.11 Fracture Description

The location of each naturally occurring fracture and mechanical break is shown in the fracture column of the rock core log. The naturally occurring fractures are numbered and described using the terminology described above for discontinuities.

The naturally occurring fractures and mechanical breaks are sketched in the drawing column. Dip angles of fractures should be measured using a protractor and marked on the log. For nonvertical borings, the angle should be measured and marked as if the boring was vertical. If the rock is broken into many pieces less than 25 mm long, the log may be crosshatched in that interval, or the fracture may be shown schematically.

The number of naturally occurring fractures observed in each 0.5 m of core should be recorded in the fracture frequency column. Mechanical breaks, thought to have occurred due to drilling, are not counted. The following criteria can be used to identify natural breaks:

1. A rough brittle surface with fresh cleavage planes in individual rock minerals indicates an artificial fracture.
2. A generally smooth or somewhat weathered surface with soft coating or infilling materials, such as talc, gypsum, chlorite, mica, or calcite obviously indicates a natural discontinuity.
3. In rocks showing foliation, cleavage or bedding it may be difficult to distinguish between natural discontinuities and artificial fractures when these are parallel with the incipient weakness planes. If drilling has been carried out carefully then the questionable breaks should be counted as natural features, to be on the conservative side.
4. Depending upon the drilling equipment, part of the length of core being drilled may occasionally rotate with the inner barrels in such a way that grinding of the surfaces of discontinuities and fractures occurs. In weak rock types it may be very difficult to decide if the resulting rounded surfaces represent natural or artificial features. When in doubt, the conservative assumption should be made; i.e., assume that they are natural.

The results of core logging (frequency and RQD) can be strongly time dependent and moisture content dependent in the case of certain varieties of shales and mudstones having relatively weakly developed diagenetic bonds. A not infrequent problem is "discing", in which an initially intact core separates into discs on incipient planes, the process becoming noticeable perhaps within minutes of core recovery. The phenomena are experienced in several different forms:

1. Stress relief cracking (and swelling) by the initially rapid release of strain energy in cores recovered from areas of high stress, especially in the case of shaley rocks.
2. Dehydration cracking experienced in the weaker mudstones and shales which may reduce RQD from 100 percent to 0 percent in a matter of minutes, the initial integrity possibly being due to negative pore pressure.
3. Slaking cracking experienced by some of the weaker mudstones and shales when subjected to wetting and drying.

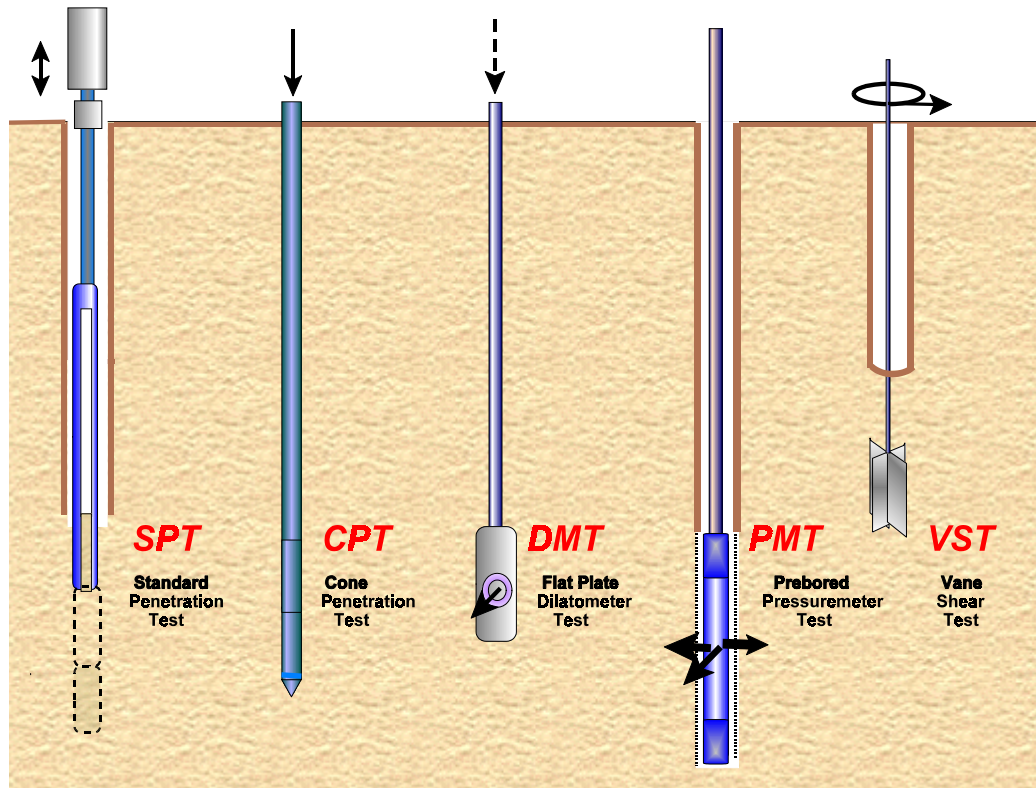
All these phenomena may make core logging of fracture frequency and RQD unreliable. Whenever such conditions are anticipated, core should be logged by an engineering geologist as it is recovered and at subsequent intervals until the phenomenon is predictable. An added advantage is that the engineering geologist can perform mechanical index tests, such as the point load index or Schmidt hammer test (see Chapter 8), while the core is still in a saturated state.



## CHAPTER 5.0

### IN-SITU GEOTECHNICAL TESTS

Several in-situ tests define the geostatigraphy and obtain direct measurements of soil properties and geotechnical parameters. The common tests include: standard penetration (SPT), cone penetration test (CPT), piezocone (CPTu), flat dilatometer (DMT), pressuremeter (PMT), and vane shear (VST). Each test applies different loading schemes to measure the corresponding soil response in an attempt to evaluate material characteristics, such as strength and/or stiffness. Figure 5-1 depicts these various devices and simplified procedures in graphical form. Details on these tests will be given in the subsequent sections.



**Figure 5-1. Common In-Situ Tests for Geotechnical Site Characterization of Soils.**

Boreholes are required for conducting the SPT and normal versions of the PMT and VST. A rotary drilling rig and crew are essential for these tests. In the case of the CPT, CPTU, and DMT, no boreholes are needed, thus termed “direct-push” technologies. Specialized versions of the PMT (i.e., full-displacement type) and VST can be conducted without boreholes. As such, these may be conducted using either standard drill rigs or mobile hydraulic systems (cone trucks) in order to directly push the probes to the required test depths. Figure 5-2 shows examples of the truck-mounted and track-mounted systems used for production penetration testing. The enclosed cabins permit the on-time scheduling of in-situ testing during any type of weather. A disadvantage of direct-push methods is that hard cemented layers and bedrock will prevent further penetration. In such cases, borehole methods prevail as they may advance by coring or noncoring techniques. An advantage of direct-push soundings is that no cuttings or spoil are generated.



**Figure 5-2. Direct-Push Technology: (a) Truck-Mounted and (b) Track-Mounted Cone Rigs.**

## 5.1 STANDARD PENETRATION TEST

The standard penetration test (SPT) is performed during the advancement of a soil boring to obtain an approximate measure of the dynamic soil resistance, as well as a disturbed drive sample (split barrel type). The test was introduced by the Raymond Pile Company in 1902 and remains today as the most common in-situ test worldwide. The procedures for the SPT are detailed in ASTM D 1586 and AASHTO T-206.

The SPT involves the driving of a hollow thick-walled tube into the ground and measuring the number of blows to advance the split-barrel sampler a vertical distance of 300 mm (1 foot). A drop weight system is used for the pounding where a 63.5-kg (140-lb) hammer repeatedly falls from 0.76 m (30 inches) to achieve three successive increments of 150-mm (6-inches) each. The first increment is recorded as a “seating”, while the number of blows to advance the second and third increments are summed to give the N-value (“blow count”) or SPT-resistance (reported in blows/0.3 m or blows per foot). If the sampler cannot be driven 450 mm, the number of blows per each 150-mm increment and per each partial increment is recorded on the boring log. For partial increments, the depth of penetration is recorded in addition to the number of blows. The test can be performed in a wide variety of soil types, as well as weak rocks, yet is not particularly useful in the characterization of gravel deposits nor soft clays. The fact that the test provides both a sample and a number is useful, yet problematic, as one cannot do two things well at the same time.

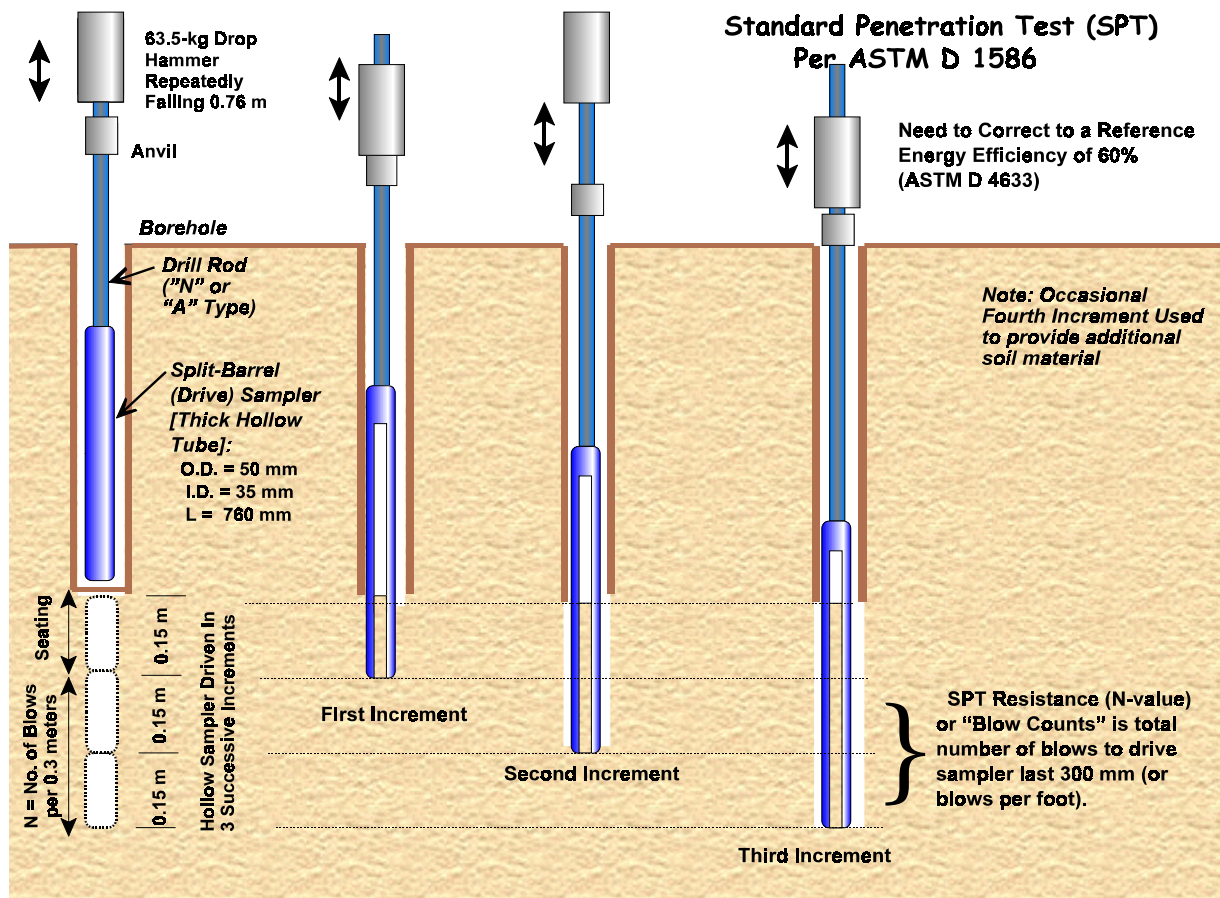
### ADVANTAGES

- Obtain both a sample & a number
- Simple & Rugged
- Suitable in many soil types
- Can perform in weak rocks
- Available throughout the U.S.

### DISADVANTAGES

- Obtain both a sample & a number\*
- Disturbed sample (index tests only)
- Crude number for analysis
- Not applicable in soft clays & silts
- High variability and uncertainty

Note: \*Collection simultaneously results in poor quality for both the sample and the number.



**Figure 5-3. Sequence of Driving Split-Barrel Sampler During the Standard Penetration Test.**

The SPT is conducted at the bottom of a soil boring that has been prepared using either flight augers or rotary wash drilling methods. At regular depth intervals, the drilling process is interrupted to perform the SPT. Generally, tests are taken every 0.76 m (2.5 feet) at depths shallower than 3 meters (10 feet) and at intervals of 1.5 m (5.0 feet) thereafter. The head of water in the borehole must be maintained at or above the ambient groundwater level to avoid inflow of water and borehole instability.

In current U.S. practice, three types of drop hammers (donut, safety, and automatic) and four types of drill rods (N, NW, A, and AW) are used in the conduct of the SPT. The test in fact is highly-dependent upon the equipment used and operator performing the test. Most important factor is the energy efficiency of the system. The theoretical energy of a free-fall system with the specified mass and drop height is 48 kg-m (350 ft-lb), but the actual energy is less due to frictional losses and eccentric loading. A rotating cathead and rope system is commonly used and their efficiency depends on numerous factors well-discussed in the open literature (e.g., Skempton, 1986), including: type of hammer, number of rope turns, conditions of the sheaves and rotating cathead (e.g., lubricated, rusted, bent, new, old), age of the rope, actual drop height, vertical plumbness, weather and moisture conditions (e.g., wet, dry, freezing), and other variables. Trends in recent times are towards the use of automated systems for lifting and dropping the mass in order to minimize these factors.

A calibration of energy efficiency for a specific drill rig & operator is recommended by ASTM D-4633 using instrumented strain gages and accelerometer measurements in order to better standardize the energy levels. Standards of practice varies from about 35% to 85% with cathead systems using donut or safety hammers, but averages about 60% in the United States. The newer automatic trip-hammers can deliver between 80 to 100% efficiency, but specifically depends on the type of commercial system. If the efficiency is measured ( $E_f$ ), then the energy-corrected N-value (adjusted to 60% efficiency) is designated  $N_{60}$  and given by:

$$N_{60} = (E_f/60) N_{meas} \quad (5-1)$$

The measured N-values should be corrected to  $N_{60}$  for all soils, if possible. The relative magnitudes of corrections for energy efficiency, sampler lining, rod lengths, and borehole diameter are given by Skempton (1986) and Kulhawy & Mayne (1990), but only as a general guide. It is mandatory to measure  $E_f$  to get the proper correction to  $N_{60}$ .

The efficiency may be obtained by comparing either the work done ( $W = F \cdot \Delta =$  force times displacement) or the kinetic energy ( $KE = \frac{1}{2}mv^2$ ) with the potential energy of the system ( $PE = mgh$ ), where  $m =$  mass,  $v =$  impact velocity,  $g = 9.8 \text{ m/s}^2 = 32.2 \text{ ft/s}^2 =$  gravitational constant, and  $h =$  drop height. Thus, the energy ratio (ER) is defined as the ratio of  $ER = W/PE$  or  $ER = KE/PE$ . It is important to note that geotechnical foundation practice and engineering usage based on SPT correlations have been developed on the basis of the standard-of-practice, corresponding to an average ER . 60 percent.

Figure 5-4 exemplifies the need for correcting N-values to a reference energy level where the successive SPTs were conducted by alternating use of donut and safety hammers in the same borehole. The energy ratios were measured for each test and gave  $34 < ER < 56$  for the donut hammer (average = 45%) and ranged  $55 < ER < 69$  for the safety hammer (average = 60%) at this site. The individual trends for the measured N-values from donut and safety hammers are quite apparent in Figure 5-4a, whereas a consistent profile is obtained in Figure 5-4b once the data have been corrected to  $ER = 60\%$ .

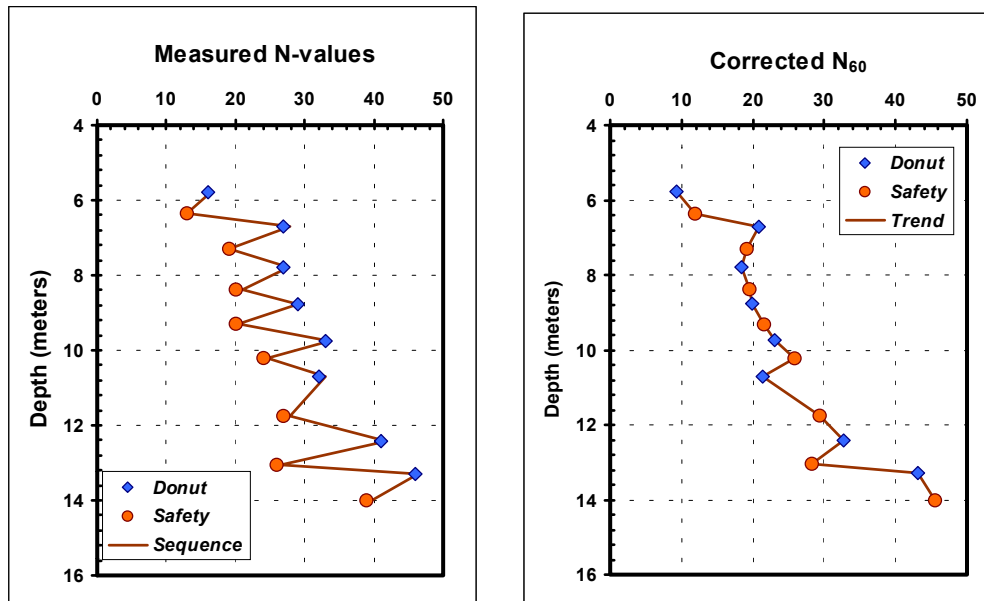


Figure 5-4. SPT-N values from (a) Uncorrected Data and (b) Corrected to 60% Efficiency. (Data modified after Robertson, et al. 1983)

In some correlative relationships, the energy-corrected  $N_{60}$  value is further normalized for the effects of overburden stress, designated  $(N_1)_{60}$ , as described in Sections 9.3 and 9.4. The  $(N_1)_{60}$  involves evaluations in clean sands for interpretations of relative density, friction angle, and liquefaction potential.

The SPT can be halted when 100 blows has been achieved or if the number of blows exceeds 50 in any given 150-mm increment, or if the sampler fails to advance during 10 consecutive blows. SPT refusal is defined by penetration resistances exceeding 100 blows per 51 mm (100/2"), although ASTM D 1586 has re-defined this limit at 50 blows per 25 mm (50/1"). If bedrock, or an obstacle such as a boulder, is encountered, the boring may be further advanced using diamond core drilling or noncore rotary methods (ASTM D 2113; AASHTO T 225) per the discretion of the geotechnical engineer. In certain cases, this SPT criterion may be utilized to define the top of bedrock within a particular geologic setting where boulders are not of concern or not of great impact on the project requirements.

## 5.2 CONE PENETRATION TESTING (CPT)

The cone penetration test is quickly becoming the most popular type of in-situ test because it is fast, economical, and provides continuous profiling of geostratigraphy and soil properties evaluation. The test is performed according to ASTM D-3441 (mechanical systems) and ASTM D 5778 (electric and electronic systems) and consists of pushing a cylindrical steel probe into the ground at a constant rate of 20 mm/s and measuring the resistance to penetration. The standard penetrometer has a conical tip with 60° angle apex, 35.7-mm diameter body (10-cm<sup>2</sup> projected area), and 150-cm<sup>2</sup> friction sleeve. The measured point or tip resistance is designated  $q_c$  and the measured side or sleeve resistance is  $f_s$ . The ASTM standard also permits a larger 43.7-mm diameter shell (15-cm<sup>2</sup> tip and 200-cm<sup>2</sup> sleeve).

The CPT can be used in very soft clays to dense sands, yet is not particularly appropriate for gravels or rocky terrain. The pros and cons are listed below. As the test provides more accurate and reliable numbers for analysis, yet no soil sampling, it provides an excellent complement to the more conventional soil test boring with SPT measurements.

### ADVANTAGES of CPT

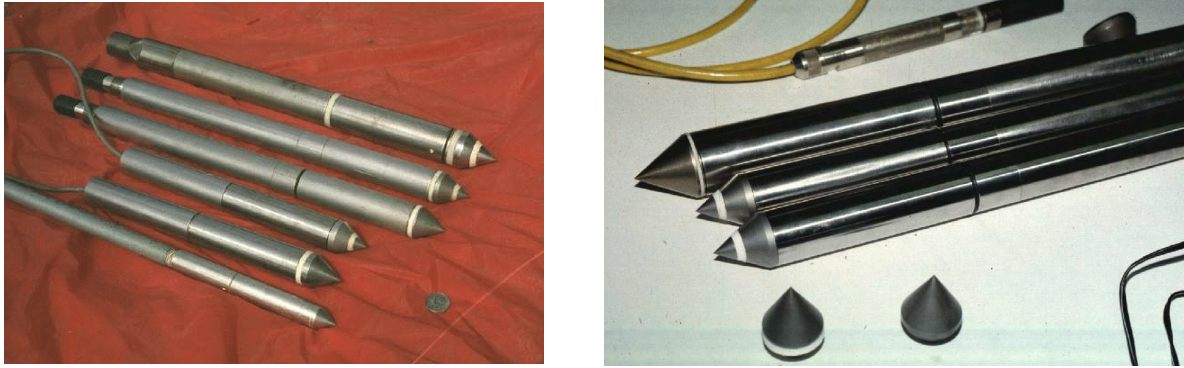
- Fast and continuous profiling
- Economical and productive
- Results not operator-dependent
- Strong theoretical basis in interpretation
- Particularly suitable for soft soils

### DISADVANTAGES of CPT

- High capital investment
- Requires skilled operator to run
- Electronic drift, noise, and calibration.
- No soil samples are obtained.
- Unsuitable for gravel or boulder deposits\*

\*Note: Except where special rigs are provided and/or additional drilling support is available.

The history of field cone penetrometers began with a design by the Netherlands Department of Public Works in 1930. This "Dutch" penetrometer was a mechanical operation using a manometer to read loads and paired sets of inner & outer rods pushed in 20-cm intervals. In 1948, electric cones permitted continuous measurements to be taken downhole. In 1965, the addition of sleeve friction measurements allowed an indirect means for classifying soil types. Later, in 1974, the electric cone was combined with a piezoprobe to form the first piezocone penetrometer. Most recently, additional sensors have been added to form specialized devices such as the resistivity cone, acoustic cone, seismic cone, vibrocone, cone pressuremeter, and lateral stress cone. Also, signal conditioning, filtering, amplification, and digitization have been incorporated within the probe itself, thus making electronic cones (Mayne, et al. 1995).



**Figure 5-5. Various Cone Penetrometers Including Electric Friction and Piezocone Types.**

Most electric/electronic cones require a cable that is threaded through the rods to connect with the power supply and data acquisition system at the surface. An analog-digital converter and pentium notebook are sufficient for collecting data at approximate 1-sec intervals. Depths are monitored using either a potentiometer (wire-spoiled LVDT), depth wheel that the cable passes through, or ultrasonics sensor. Systems can be powered by voltage using either generator (AC) or battery (DC), or alternatively run on current. New developments include: (1) the use of audio signals to transmit digital data up the rods without a cable and (2) memocone systems where a computer chip in the penetrometer stores the data throughout the sounding.

#### **Piezocone Penetration Testing (PCPT or CPTu)**

Piezocones are cone penetrometers with added transducers to measure penetration porewater pressures during the advancement of the probe. In clean sands, the measured penetration pore pressures are nearly hydrostatic ( $u_{meas} \approx u_o$ ) because the high permeability of the sand permits immediate dissipation. In clays, however, the undrained penetration results in the development of high excess porewater pressures above hydrostatic. These excess  $u$  can be either positive or negative, depending upon the specific location of the porous element (filter stone) along the cone probe. If the penetration is arrested, the decay of porewater pressures can be monitored with time and used to infer the rate of consolidation and soil permeability.

The measurement of porewater pressures requires careful preparation of the porous elements and cone cavities to ensure saturation and reliable measurements of  $u$  during testing. Porous filter stones can be made of stone, ceramics, sintered steel or brass or copper, and plastic. Polypropylene is economical for replacement and discard for each sounding, particularly important if clogging or smearing is considered problematic. However, in certain soil types, the compressibility of the filter material can affect the measured results (Campanella & Robertson 1988). Although water can be used for saturation, glycerin or silicon offer a better means of penetrating through unsaturated zones to avoid losing cone saturation before encountering the groundwater table.

Commercial penetrometers have the porous element either midface (designated  $u_1$  or  $u_1$ ), or at the shoulder, just behind the cone tip (designated  $u_b$  or  $u_2$ ), as depicted in Figure 5-6. As a rule, measured porewater pressures are such that  $u_1 > u_2$ . For Type 1 piezocones, the measured porewater pressures are always positive. For Type 2 cones, however, measured  $u_2$  are positive in soft to stiff clays, but are zero or negative in fissured overconsolidated clays and dense dilatant sands. The "standard" piezocone penetrometer has a shoulder position ( $u_2$ ) because of a necessary correction for the measured tip stress  $q_c$ .

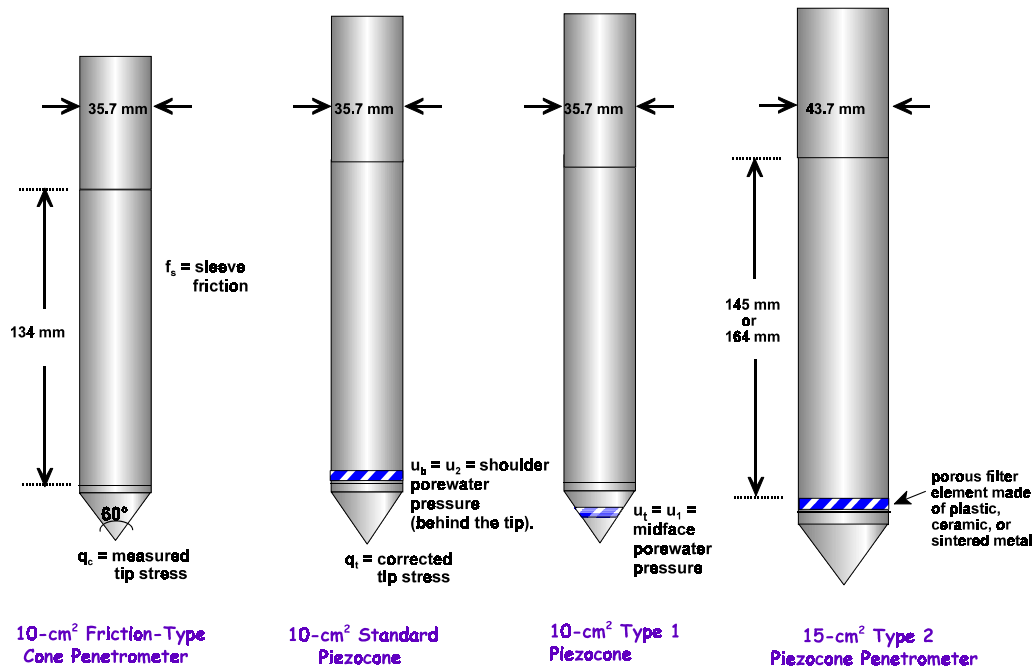


Figure 5-6. Geometry and Measurements Taken by Cone and Piezocone Penetrometers.

The measured cone resistance ( $q_c$ ) must be corrected for porewater pressures acting on unequal areas of the cone tip. This correction is most important for soft to firm to stiff clays and silts and for very deep soundings where high hydrostatic pressures exist. Usually in sands, the correction is minimal because  $q_c \gg u_2$ . The corrected resistance is given by (Lunne, et al. 1997):

$$q_T = q_c + (1-a_n)u_2 \quad (5-2)$$

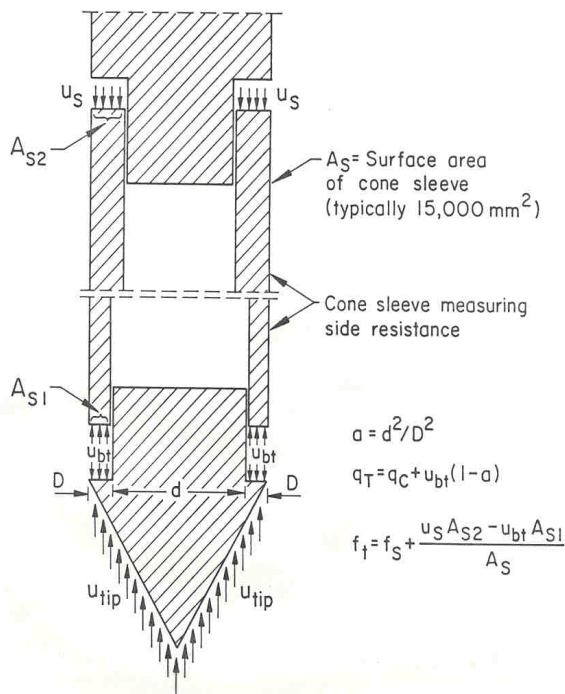


Figure 5-7. Correction Detail for Porewater Pressures Acting on Cone Tip Resistance.

where  $a_n$  = net area ratio determined from calibration of the cone in a triaxial chamber. Penetrometers with values of  $a_n \leq 0.8$  are desired in order to minimize the corrections, yet provide sufficient steel wall thickness of the cylinder against buckling. Most 10-cm<sup>2</sup> commercial penetrometers have  $0.75 < a_n \leq 0.82$  and many 15-cm<sup>2</sup> cones show  $0.65 < a_n < 0.8$ , yet several older models indicate values as low as  $a_n = 0.35$ . The value of  $a_n$  should be provided by the manufacturer. For a type 1 cone, the correction cannot be made reliably because an assumed conversion from  $u_1$  to  $u_2$  pressures must be made, but this depends on stress history, sensitivity, cementation, fissuring, and other effects (Mayne et al., 1990). In soils where the measured  $u_2 \leq 0$  (or slightly negative), the use of a type 1 piezocone is warranted because the correction is negligible and better stratigraphic detailing of the subsurface profile is obtained.

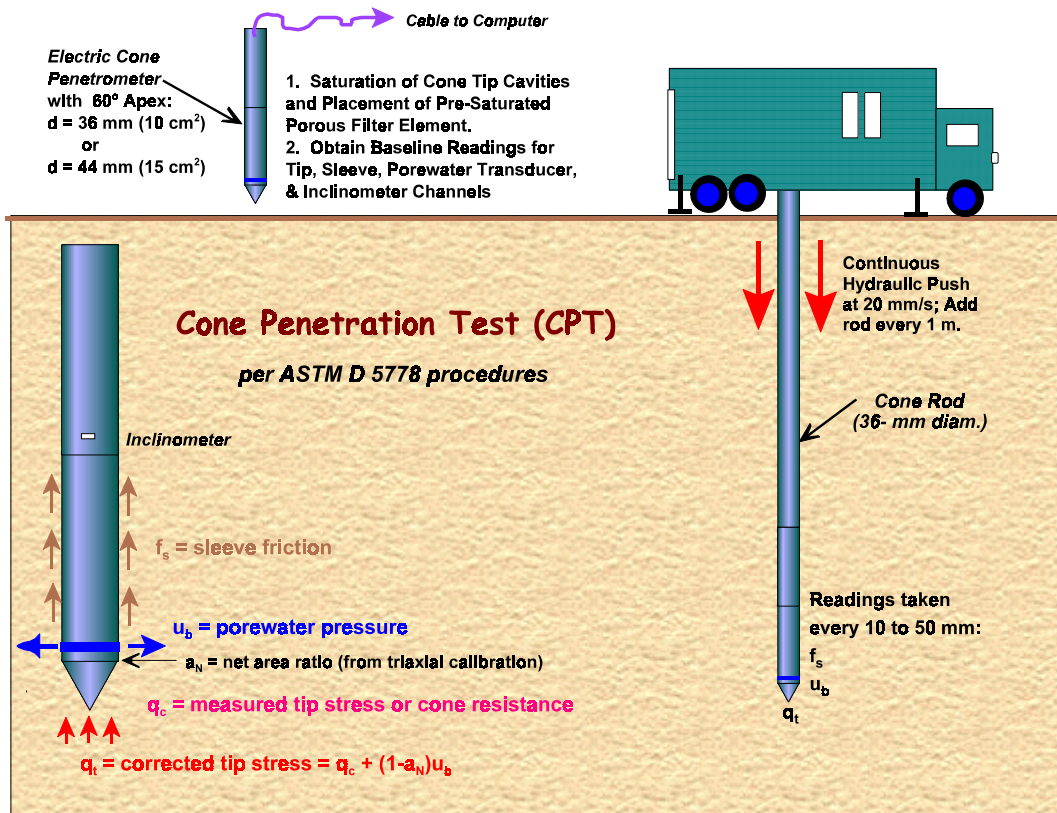


Figure 5-8. Procedures and Components of the Cone Penetration Test.

### Baseline Readings

Prior to and after the conduct of an electric CPT sounding, it is very important to take initial baseline readings (“zeros”) of the separate channels before advancing the penetrometer. All commercial and research CPT systems require a baseline set of readings. These baselines represent the relative conditions when there are no forces on the load cells and transducers. The electrical signals values may shift before or during a sounding due to thermal effects (air, water, humidity, barometric pressures, ground temperatures, or frictional heat), as well as power interruptions or electromagnetic interference. Therefore, careful monitoring and recording of the baseline readings should be taken by the operator. This may necessitate use of a zero-offset of a particular channel accordingly.

### Routine CPTu Operations

The field testing engineer or technician should maintain a log of the calibration, maintenance, and routine operation of the cone penetrometer system. Each penetrometer should have a unique identification number. The field book should list the recorded calibration values of the load cells for tip and sleeve readings, porewater transducer, inclinometer, and any other sensors or channels. The net area ratio ( $a_n$ ) should be listed for the particular cone. A clean filter element should be properly saturated (preferably with glycerine) at least one day prior to the sounding. The cone ports & filter should be carefully assembled and filled with glycerine (or alternate acceptable fluid) just before the test.



Prior to (and after) each sounding, a stable set of baseline readings should be taken and recorded in the field book. The computer operation & data collection depend often on the particular commercial system that is utilized. The sounding should only commence once all channels are stable in their initial values (Reasonable ranges of initial values are often provided by the manufacturer). After the sounding is completed and the cone removed from the ground, the initial & final baselines should be compared to verify that they are similar, otherwise adjustments may be necessary to the recorded data.

The equipment should be maintained in proper condition in order to collect quality and reliable data. Thus, the field engineer or technician should inspect the penetrometer system for obvious defects, wear, and omissions prior to usage. Detailed recommendations are given in ASTM D 5778 and Lunne, et al. (1997). Briefly, these may include periodic cleaning of the penetrometer and rods, replacement of worn tips & sleeves, inspection of the electronic cables and power connections, removal of bent rods, and other maintenance issues.

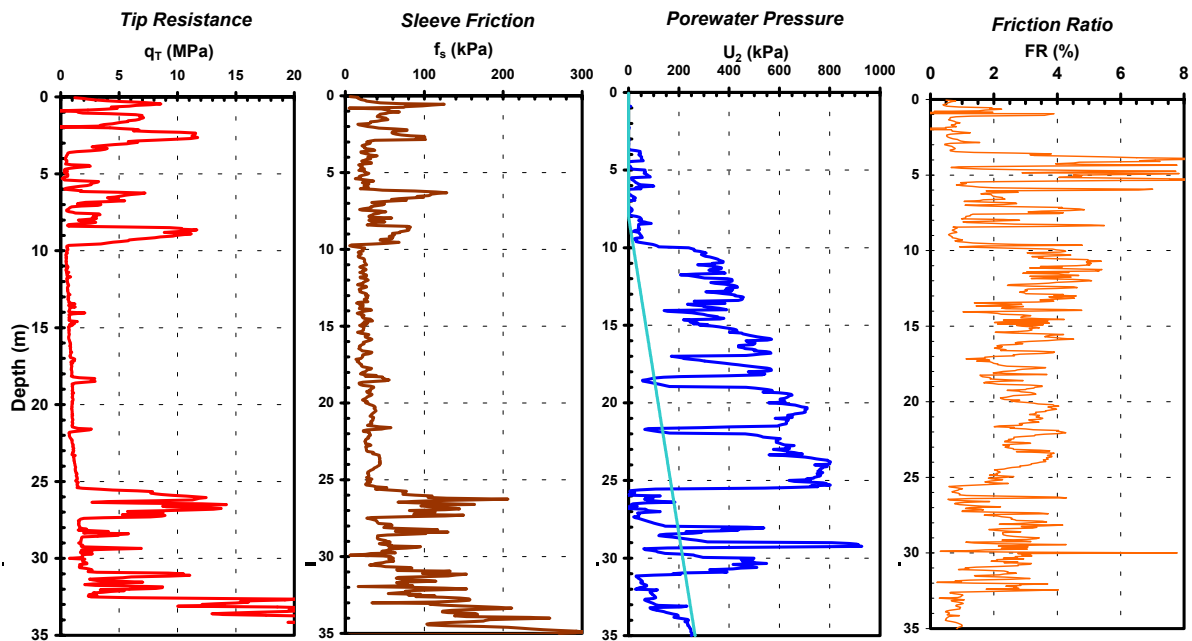


Figure 5-9. Piezocone Results next to Mississippi River, Memphis, TN.

### CPT Profiles

The results of the individual channels of a piezocone penetration test are plotted with depth, as illustrated in Figure 5-8. With the continuous records and three independent channels, it is easy to discern detailed changes in strata and the inclusion of seams and lenses with the subsurface profile.

Since soil samples are not obtained with the CPT, an indirect assessment of soil behavioral type is inferred by an examination of the readings. The numbers can be processed for use in empirical chart classification systems (as given in Chapter 9), or the raw readings easily interpreted by eye for soil strata changes. For example, clean sands are generally evidenced by  $q_T > 5$  MPa (50 tsf), while soft to stiff clays & silts evidence  $q_T < 2$  MPa (20 tsf). Generally, penetration porewater pressures in loose sands exhibit  $u_b \approx u_o$ , whereas dense sands show  $u_b < u_o$ . In soft to stiff intact clays, penetration porewater pressures are several times hydrostatic ( $u_b \gg u_o$ ). Notably, negative porewater pressures are observed in fissured

overconsolidated materials. The sleeve friction, often expressed in terms of a friction ratio  $FR = f_s/q_T$ , also is a general indicator of soil type. In sands, usually  $0.5\% < FR < 1.5\%$ ; and in clays, normally  $3\% < FR < 10\%$ . A notable exception is that in sensitive and quick clays, a low FR is observed. In fact, an approximate estimate of the clay sensitivity is suggested as  $10/FR$  (Robertson & Campanella, 1983).

In the above sounding (Figure 5-8), a variable interlayered sandy stratum with clay and silt lenses occurs from the ground surface to a depth of 10 meters. This is underlain by a thick layer of silty clay to depths of 25 meters, as evidenced by the low  $q_t$  and high  $u_b$  readings (well above hydrostatic), as well as the FR values from 3.5 up to 4.0%. Beneath this layer, a sandy silt layer is noted to 33 m that is underlain by dense sand within the termination depth of the sounding. Additional details and information on soil behavioral classification by CPT is given in Section 9.2.

### 5.3 VANE SHEAR TEST (VST)

The vane shear test (VST), or field vane (FV), is used to evaluate the in-place undrained shear strength ( $s_{uv}$ ) of soft to stiff clays & silts at regular depth intervals of 1 meter (3.28 feet). The test consists of inserting a four-bladed vane into the clay and rotating the device about a vertical axis, per ASTM D 2573 guidelines. Limit equilibrium analysis is used to relate the measured peak torque to the calculated value of  $s_{uv}$ . Both the peak and remolded strengths can be measured; their ratio is termed the sensitivity,  $S_t$ . A selection of vanes is available in terms of size, shape, and configuration, depending upon the consistency and strength characteristics of the soil. The standard vane has a rectangular geometry with a blade diameter  $D = 65$  mm, height  $H = 130$  mm ( $H/D = 2$ ), and blade thickness  $e = 2$  mm.

The test is best performed when the vane is pushed beneath the bottom of a pre-drilled borehole. For a borehole of diameter  $B$ , the top of the vane should be pushed to a depth of insertion of at least  $df = 4B$ . Within 5 minutes after insertion, rotation should be made at a constant rate of  $6^\circ/\text{minute}$  ( $0.1^\circ/\text{s}$ ) with measurements of torque taken frequently. Figure 5-9 illustrates the general VST procedures. In very soft clays, a special protective housing that encases the vane is also available where no borehole is required and the vane can be installed by pushing the encasement to the desired test depth to deploy the vane. An alternative approach is to push two side-by-side soundings (one with the vane, the other with rods only). Then, the latter rod friction results are subtracted from the former to obtain the vane readings. This alternate should be discouraged as the rod friction readings are variable, depend upon inclination and verticality of the rods, number of rotations, and thus produce unreliable and questionable data.

#### ADVANTAGES of VST

- Assessment of undrained strength,  $s_{uv}$
- Simple test and equipment
- Measure in-situ clay sensitivity ( $S_t$ )
- Long history of use in practice

#### DISADVANTAGES of VST

- Limited application to soft to stiff clays
- Slow and time-consuming
- Raw  $s_{uv}$  needs (empirical) correction
- Can be affected by sand lenses and seams

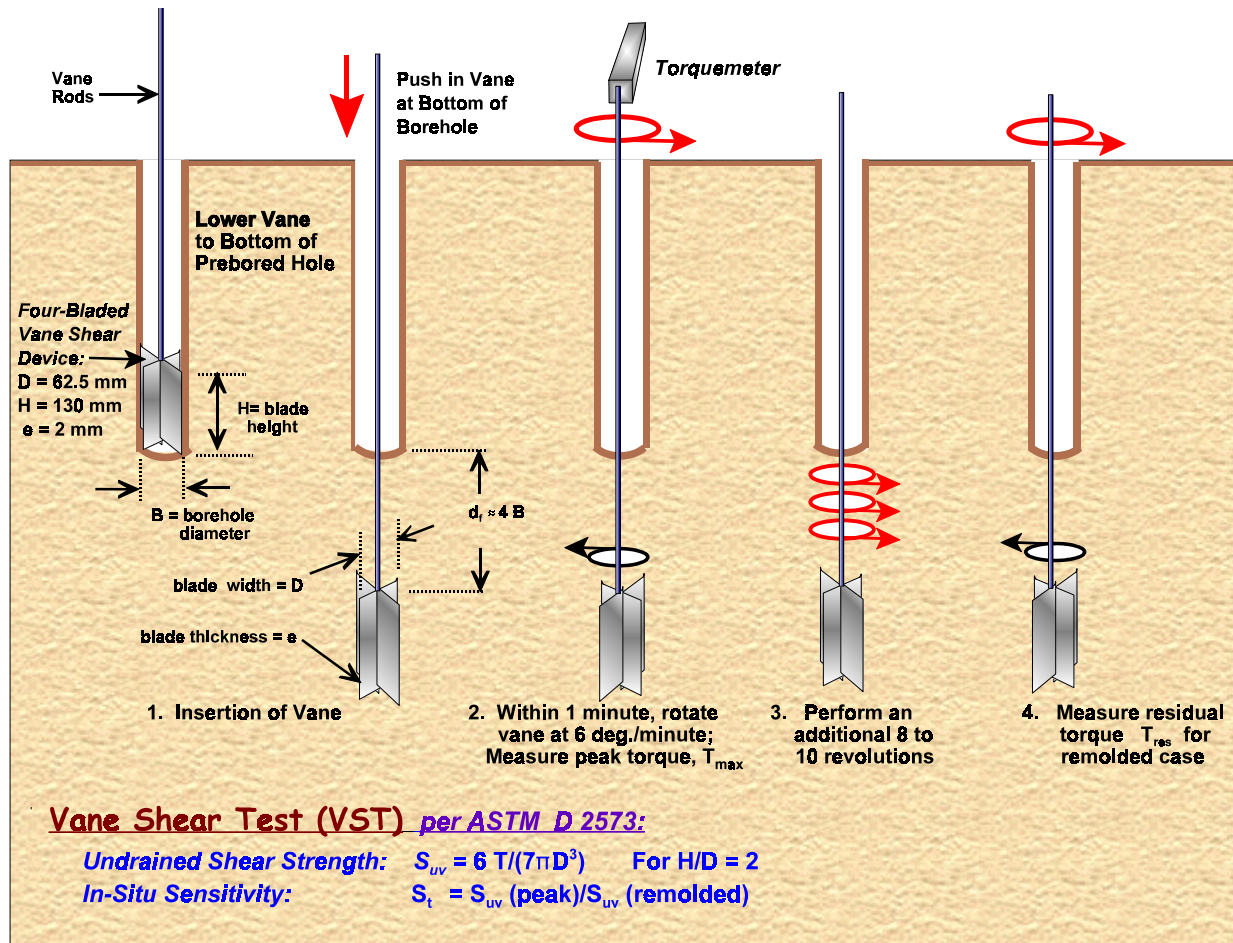


Figure 5-10. General Test Procedures for the Field Vane in Fine-Grained Soils. (Note: Interpretation of undrained strength shown is specifically for standard rectangular vane with  $H/D = 2$ ).

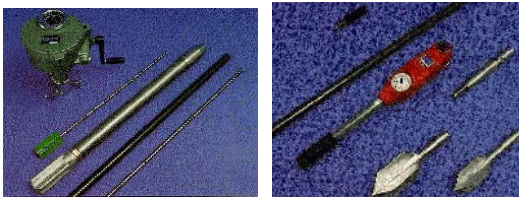
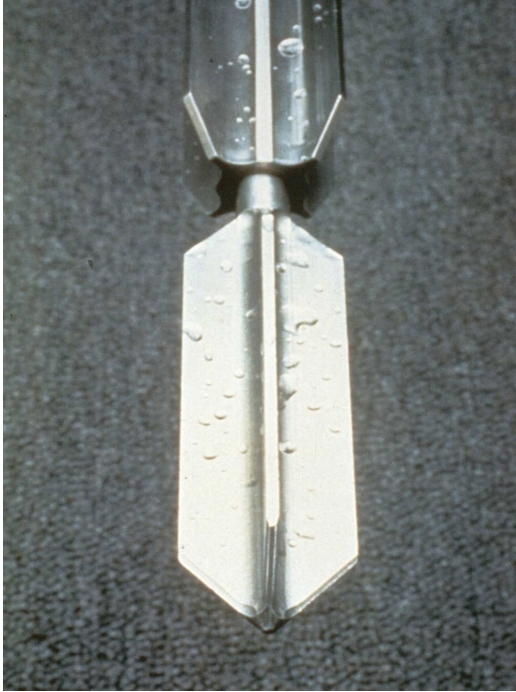
### Undrained Strength and Sensitivity

The conventional interpretation for obtaining the undrained shear strength from the recorded maximum torque ( $T$ ) assumes a uniform distribution of shear stresses both top and bottom along the blades and a vane with height-to-width ratio  $H/D = 2$  (Chandler, 1988):

$$s_{uv} = \frac{6T_{\max}}{7\pi D^3} \quad (5-3)$$

regardless of units so long as torque  $T$  and width  $D$  are in consistent units (e.g., kN-m and meters, respectively, to provide vane strength  $s_{uv}$  in kN/m<sup>2</sup>). The test is normally reserved for soft to stiff materials with  $s_{uv} < 200$  kPa. (2 tsf). After the peak  $s_{uv}$  is obtained, the vane is rotated quickly through 10 complete revolutions and the remolded (or "residual") value is recorded. The in-situ sensitivity of the soil is defined by:

$$S_t = s_u(\text{peak})/s_u(\text{remolded}) \quad (5-4)$$

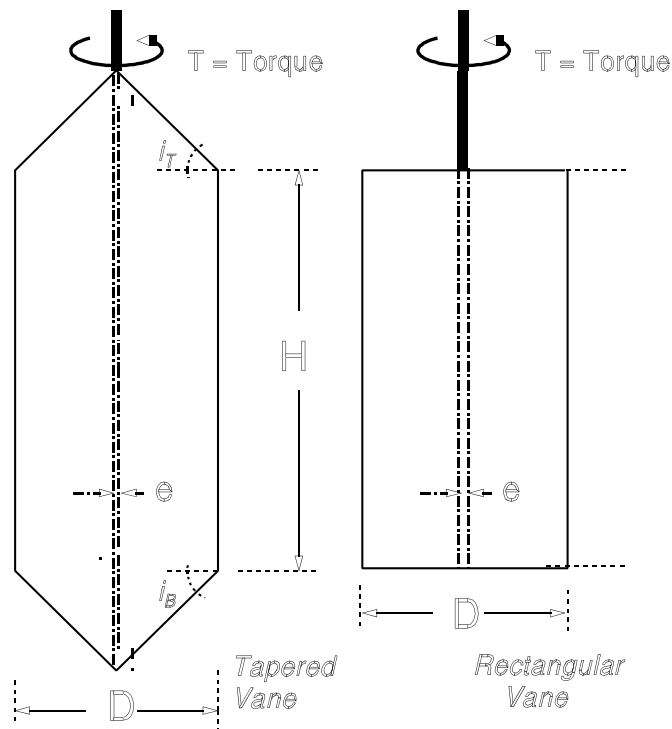


**Figure 5-11. Selection of Vane Shear Blades, Pushing Frames, and Torquemeter Devices.**

The general expression for all types of vanes including standard rectangular (Chandler, 1988), both ends tapered (Geonor in Norway), bottom taper only (Nilcon in Sweden), as well as rhomboidal shaped vanes for any end angles is given by:

$$s_{uv} = \frac{12T}{\pi D^2 \left[ \left( \frac{D}{\cos i_T} \right) + \left( \frac{D}{\cos i_B} \right) + 6H \right]} \quad (5-5)$$

where  $i_T$  = angle of taper at top (with respect to horizontal) and  $i_B$  = angle of bottom taper, as defined in Figure 5-11.



**Figure 5-12. Definitions of Vane Geometries for Tapered & Rectangular Blades.**

For the commercial vanes in common use, equation (5-5) reduces to the following expressions for vanes with blade heights that are twice their widths ( $H/D = 2$ ):

$$\text{Rectangular } (i_T = 0^\circ \text{ and } i_B = 0^\circ): \quad s_{uv} = 0.273 T_{\max}/D^3 \quad (5-5a)$$

$$\text{Nilcon } (i_T = 0^\circ \text{ and } i_B = 45^\circ): \quad s_{uv} = 0.265 T_{\max}/D^3 \quad (5-5b)$$

$$\text{Geonor } (i_T = 45^\circ \text{ and } i_B = 45^\circ): \quad s_{uv} = 0.257 T_{\max}/D^3 \quad (5-5c)$$

Note that equation (5-5a) is identical to (5-3) for the rectangular vane.

### Vane Results

A representative set of shear strength profiles in San Francisco Bay Mud derived from vane shear tests for the MUNI Metro Station Project are shown in Figure 5-12a. Peak strengths increase from  $s_{uv} = 20$  kPa to 60 kPa with depth. The derived profile of sensitivity (ratio of peak to remolded strengths) is presented in Figure 5-12b and indicates  $3 < S_t < 4$ .

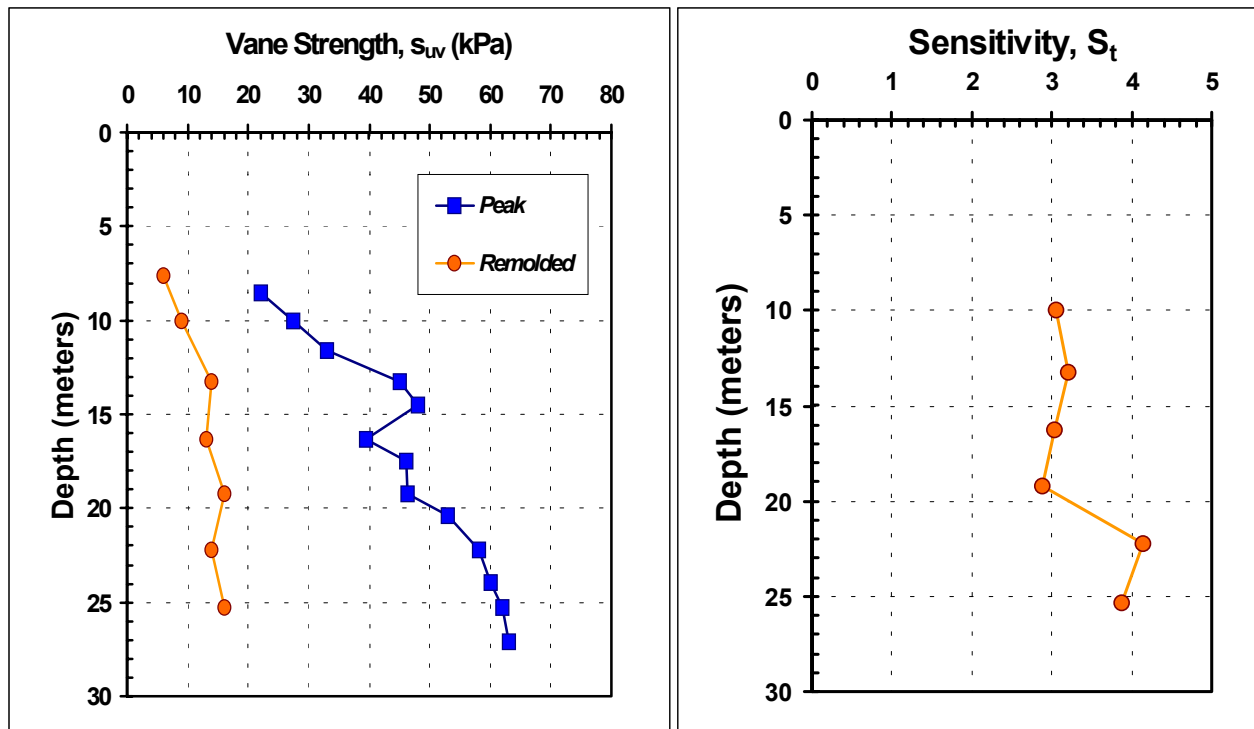


Figure 5-13. Illustrative Results from VSTs Conducted in San Francisco Bay Mud showing Profiles of (a) Peak and Remolded Vane Strengths, and (b) derived Clay Sensitivity.

### Vane Correction Factor

It is very important that the measured vane strength be corrected prior to use in stability analyses involving embankments on soft ground, bearing capacity, and excavations in soft clays. The mobilized shear strength is given by:

$$J_{\text{mobilized}} = \alpha_R s_{uv} \quad (5-6)$$

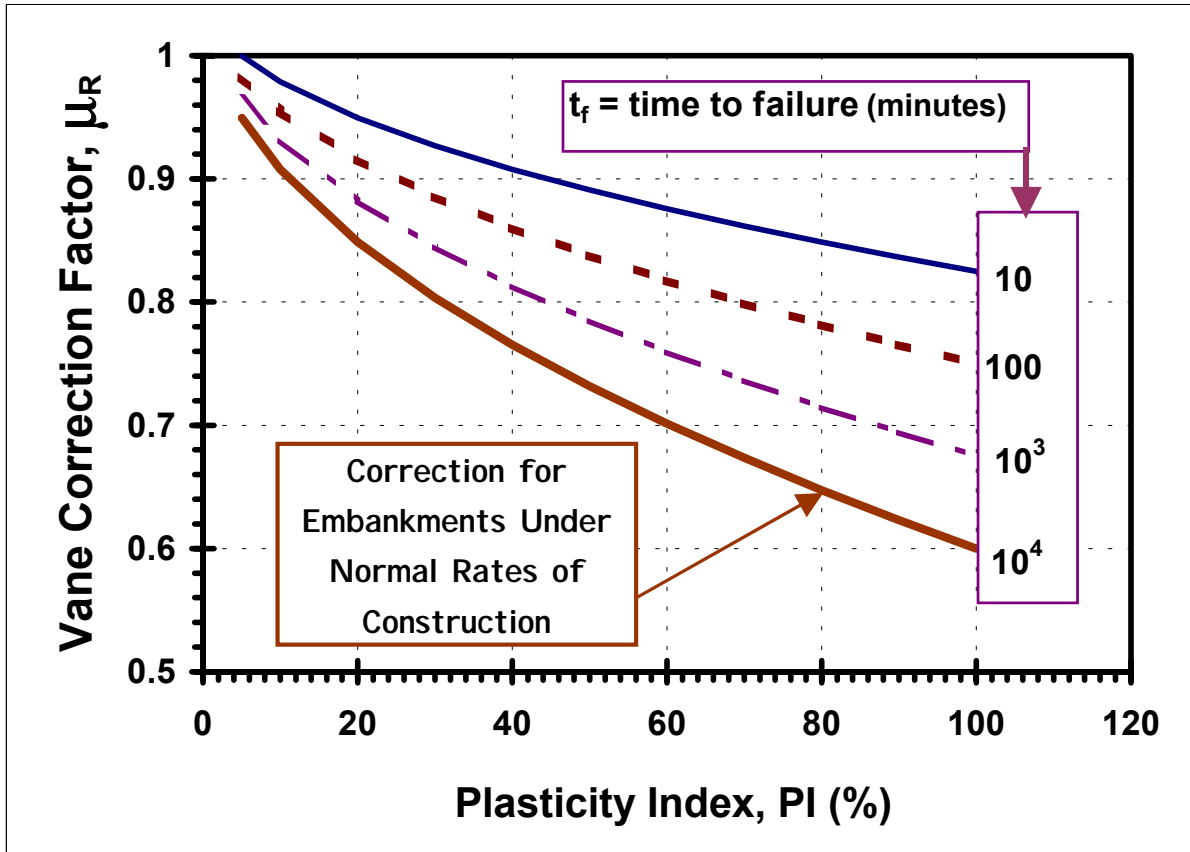
where  $\alpha_R$  = empirical correction factor that has been related to plasticity index (PI) and/or liquid limit (LL) based on backcalculation from failure case history records of full-scale projects. An extensive review of the factors and relationships affecting vane measurements in clays and silts with  $PI > 5\%$  recommends the following expression (Chandler, 1988):

$$\alpha_R = 1.05 - b (PI)^{0.5} \quad (5-7)$$

where the parameter  $b$  is a rate factor that depends upon the time-to-failure ( $t_f$  in minutes) and given by:

$$b = 0.015 + 0.0075 \log t_f \quad (5-8)$$

The combined relationships are shown in Figure 5.13. For guidance, embankments on soft ground are normally associated with  $t_f$  on the order of  $10^4$  minutes because of the time involved in construction using large equipment.



**Figure 5-14. Vane Correction Factor ( $\mu_R$ ) Expressed in Terms of Plasticity Index and Time to Failure.**  
 (Adapted from Chandler, 1988). Note: For stability analyses involving normal rates of embankment construction, the correction factor is taken at the curve corresponding to  $t_f = 10,000$  minutes.

A common means of comparing vane measurements in different clays and silts is via the normalized undrained shear strength to effective overburden stress ratio ( $s_{uv}/F_{vo}r$ ), formerly termed the  $c/p\bar{\sigma}$  ratio in older textbooks. Interestingly, the ( $s_{uv}/F_{vo}r$ ) for normally-consolidated clays obtained from raw vane strength measurements has long been observed to increase with plasticity index (e.g., Kulhawy & Mayne, 1990). A common expression cited is:  $(s_{uv}/F_{vo}r)_{uncorrected} = 0.11 + 0.0037 PI$ , where  $PI$  = clay plasticity index. Yet, the vane correction factor ( $\mu_R$ ) decreases with  $PI$ , as shown by Figure 5-13. The net effect is that the mobilized undrained shear strength backcalculated from failure case histories involving embankments, foundations, and excavations in soft clays is essentially independent of plasticity index (Terzaghi, et al. 1996). For further information, a detailed review of the device, the procedures, and methods of interpretation for the VST are given by Chandler (1988).

## 5.4 FLAT PLATE DILATOMETER TEST (DMT)

The flat dilatometer test (DMT) uses pressure readings from an inserted plate to obtain stratigraphy and estimates of at-rest lateral stresses, elastic modulus, and shear strength of sands, silts, and clays. The device consists of a tapered stainless steel blade with 18° wedge tip that is pushed vertically into the ground at 200 mm depth intervals (or alternative 300-mm intervals) at a rate of 20 mm/s. The blade (approximately 240 mm long, 95 mm wide, and 15 mm thick) is connected to a readout pressure gauge at the ground surface via a special wire-tubing through drill rods or cone rods. A 60-mm diameter flexible steel membrane located on one side of the blade is inflated pneumatically to give two pressures: “A-reading” that is a lift-off or contact pressure where the membrane becomes flush with the blade face ( $s^* = 0$ ); and “B-reading” that is an expansion pressure corresponding to  $s^* = 1.1$  mm outward deflection at center of membrane. A tiny spring-loaded pin at the membrane center detects the movement and relays to a buzzer/galvanometer at the readout gauge. Normally, nitrogen gas is used for the test because of the low moisture content, although carbon dioxide or air can also be used. Reading “A” is obtained about 15 seconds after insertion and “B” is taken within 15 to 30 seconds later. Upon reaching “B”, the membrane is quickly deflated and the blade is pushed to the next test depth. If the device cannot be pushed because of limited hydraulic pressure (such as dense sands), then it can be driven in place, but this is not normally recommended.

### ADVANTAGES OF DMT

- Simple and Robust
- Repeatable & Operator-Independent
- Quick and economical

### DISADVANTAGES OF DMT

- Difficult to push in dense and hard materials.
- Primarily relies on correlative relationships.
- Need calibrations for local geologies.

Procedures for the test are given by ASTM D 6635 and Schmertmann (1986) and Figure 5-14 provides an overview of the device and its operation sequence. Two calibrations are taken before the sounding to obtain corrections for the membrane stiffness in air. These corrected “A” and “B” pressures are respectively notated as  $p_0$  and  $p_1$  with the original calculations given by (Marchetti 1980):

$$p_0 = A + ) A \quad (5-9)$$

$$p_1 = B - ) B \quad (5-10)$$

where ) A and ) B are calibration factors for the membrane stiffness in air. The ) A calibration is obtained by applying suction to the membrane and ) B obtained by pressurizing the membrane in air (Note: both are recorded as positive values). In stiff soils, equations (5-9) and (5-10) will normally suffice for calculating the contact pressure  $p_0$  and expansion pressure  $p_1$ . However, in soft clays & silts, a more accurate correction procedure is given by (Schmertmann 1986):

$$p_0 = 1.05(A + ) A - z_m - 0.05(B - ) B - z_m \quad (5-11)$$

$$p_1 = B - ) B - z_m \quad (5-12)$$

where  $z_m$  = pressure gage offset (i.e., zero reading of gage). Normally for a new gage,  $z_m = 0$ . Equations (5-11) and (5-12) are to be preferred in general over the earlier equations (5-9) and (5-10).



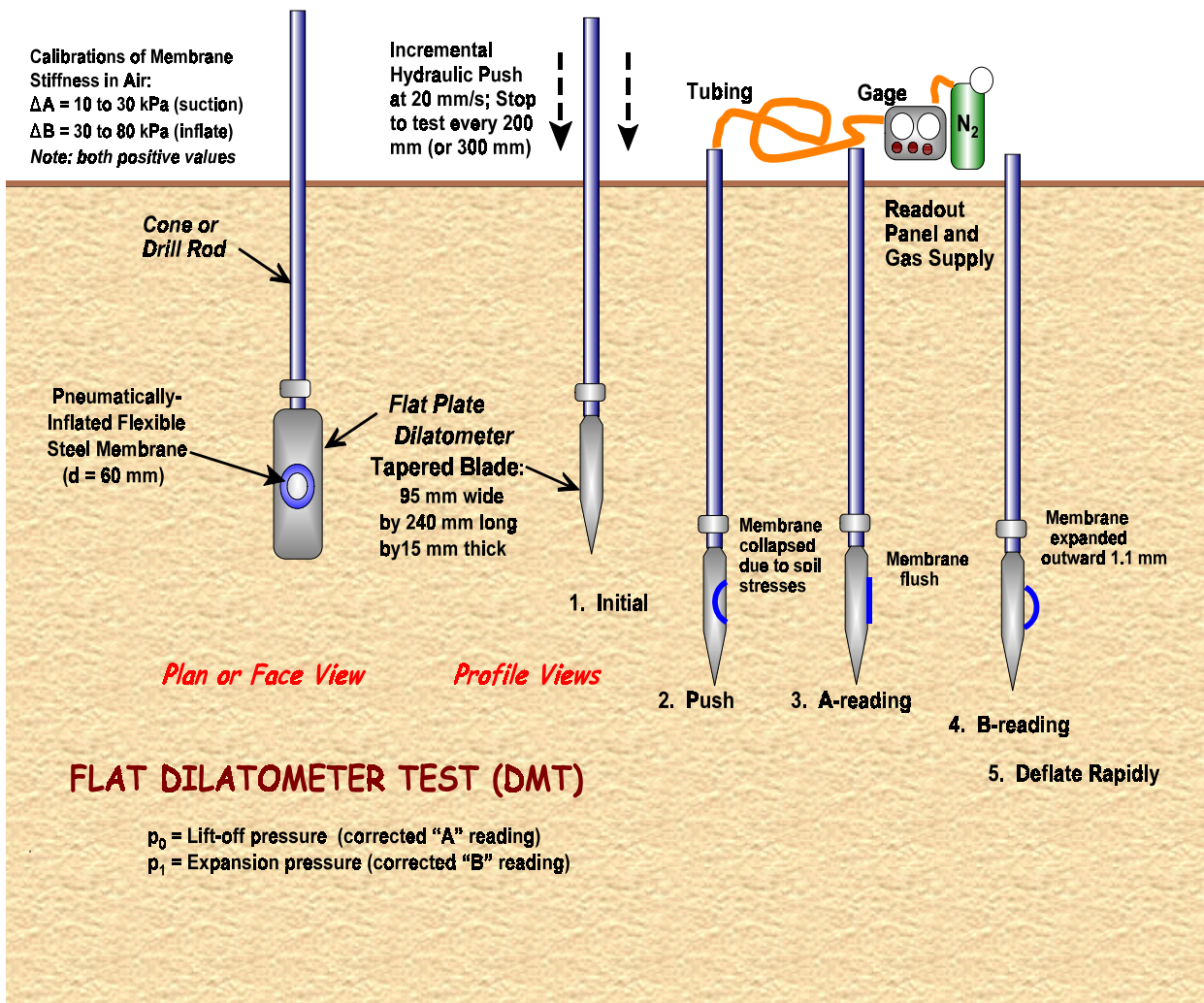


Figure 5-15. Setup and Sequence of Procedures for the Flat Plate Dilatometer Test.

The two DMT readings ( $p_0$  and  $p_1$ ) are utilized to provide three indices that can provide information on the stratigraphy, soil types, and the evaluation of soil parameters:

● *Material Index:* 
$$I_D = (p_1 - p_0)/(p_0 - u_0) \quad (5-13)$$

● *Dilatometer Modulus:* 
$$E_D = 34.7(p_1 - p_0) \quad (5-14)$$

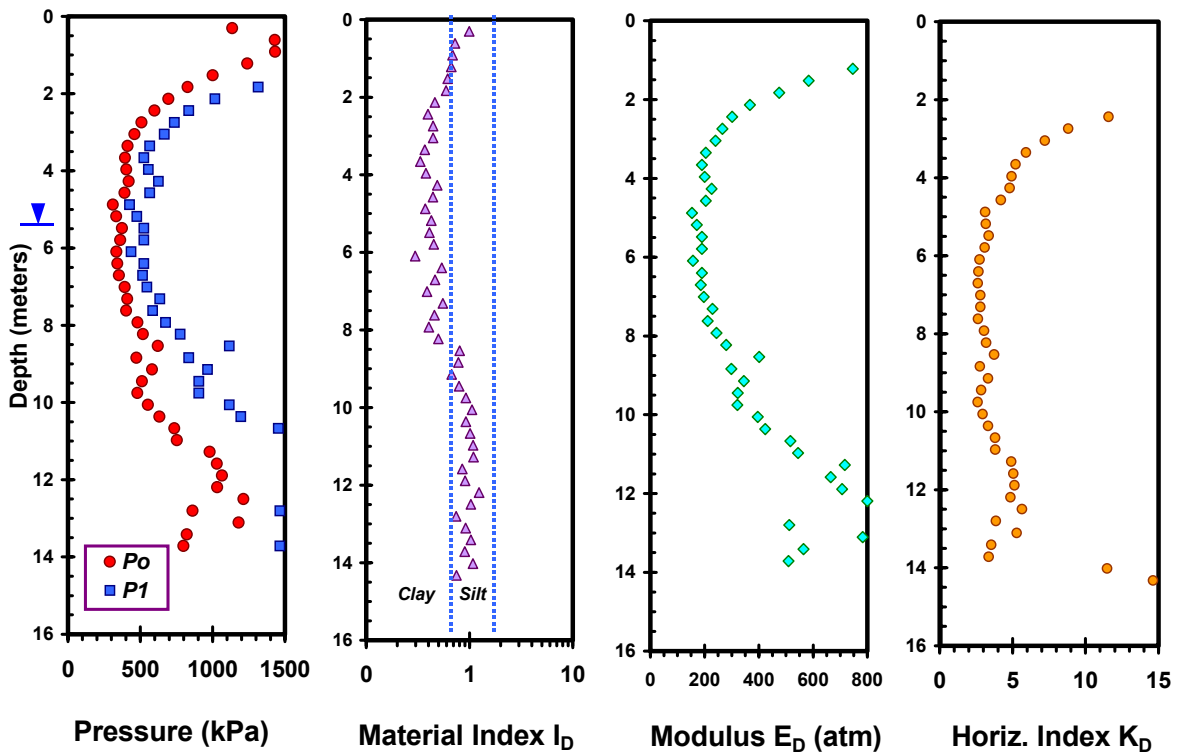
● *Horizontal Stress Index:* 
$$K_D = (p_0 - u_0)/F_{v0}N \quad (5-15)$$

where  $u_0$  = hydrostatic porewater pressure and  $F_{v0}N$  = effective vertical overburden stress. For soil behavioral classification, layers are interpreted as clay when  $I_D < 0.6$ , silts within the range of  $0.6 < I_D < 1.8$ , and sands when  $I_D > 1.8$ .



**Figure 5-16. Flat Plate Dilatometer Equipment: (a) Modern Dual-Element Gauge System; (b) Early Single-Gauge Readout; (c) Computerized Data Acquisition Model.**

Example results from a DMT conducted in Piedmont residual soils are presented in Figure 5-16, including the measured lift-off ( $p_0$ ) and expansion ( $p_1$ ) pressures, material index ( $I_D$ ), dilatometer modulus ( $E_D$ ), and horizontal stress index ( $K_D$ ) versus depth. The soils are fine sandy clays and sandy silts derived from the in-place weathering of schistose and gneissic bedrock.



**Figure 5-17. Example DMT Sounding in Piedmont residual soils (CL to ML) in Charlotte, NC.**

The total soil unit weight ( $\gamma_T$ ) can be evaluated from the material index and dilatometer modulus. For spreadsheet use, the approximate expression is:

$$\gamma_T = 1.12 \left( \gamma_w (E_D/F_{atm})^{0.1} (I_D)^{-0.05} \right) \quad (5-16)$$

where  $\gamma_w$  = unit weight of water and  $F_{atm}$  = atmospheric pressure. For each successive layer, the cumulative total overburden stress ( $F_{vo}$ ) can be calculated, as this is needed for the determination of the effective vertical overburden stress ( $F_{vo} \gamma = F_{vo} - u_o$ ) and the evaluation of the  $K_D$  parameter.

Modifications to the basic DMT test include: (1) a “C-reading” (or  $p_2$ ) that corresponds to the A-position during deflating of the membrane; (2) the measurement of thrust force during successive test intervals; (3) dissipation readings with time; and (4) addition of a geophone to permit downhole shear wave velocity measurements. General interpretation methods for soil parameters from the DMT are given in Chapter 9.

## 5.5 PRESSUREMETER TEST (PMT)

The pressuremeter test consists of a long cylindrical probe that is expanded radially into the surrounding ground. By tracking the amount of volume of fluid and pressure used in inflating the probe, the data can be interpreted to give a complete stress-strain-strength curve. In soils, the fluid medium is usually water (or gas), while in weathered and fractured rocks, hydraulic oil is used.

The original “pressiometer” was introduced by the French engineer Louis Menard in 1955. This prototype had a complex arrangement of water and air tubing and plumbing with pressure gauges and valves for testing. More recently, monocell designs facilitate the simple use of pressurized water using a screw pump. Procedures and calibrations are given by ASTM D 4719 with Figure 5-17 giving a brief synopsis. Standard probes range from 35 to 73 mm in diameter with length-to-diameter ratios varying from  $L/d = 4$  to 6 depending upon the manufacturer.

### ADVANTAGES OF PMT

- Theoretically sound in determination of soil parameters;
- Tests larger zone of soil mass than other in-situ tests;
- Develop complete  $F$ -,  $-J$  curve.

### DISADVANTAGES OF PMT

- Complicated procedures; requires high level of expertise in the field;
- Time consuming and expensive (good day gives 6 to 8 complete tests);
- Delicate, easily damaged.

There are four basic types of pressuremeter devices:

1. *Prebored (Menard) type* pressuremeter (MPMT) is conducted in a borehole, usually after pushing and removing a thin-walled (Shelby) tube. The MPMT is depicted in Figure 5-17. The initial response reflects a recompression region as probe inflates to meet walls of boring and contact with soil.

2. *Self-boring pressuremeter* (SBP) is a probe placed at the bottom of borehole and literally eats its way into the soil to minimize disturbance and preserve the  $K_o$  state of stress in the ground. Either cutter teeth or water jetting is used to advance the probe and cuttings are transmitted through its hollow center. The probe has three internal radial arms to directly measure cavity strain,  $\epsilon_c = dr/r_o$ , where  $r_o$  = initial probe radius and  $dr$  = radial change. Assuming the probe expands radially as a cylinder, volumetric strain is related to cavity strain by the expansion:  $(V/V_o) = 1 - (1 + \epsilon_c)^2$

3. *Push-in pressuremeter* (PIP) consists of a hollow thick walled probe having an area ratio of about 40 percent. Faster than prebored and SBP above, but disturbance effects negate any meaningful  $K_o$  measurements.

4. *Full-displacement type* (FDP): Similar to push-in type but complete displacement effects. Often incorporated with a conical point to form a cone pressuremeter (CPMT) or pressiocone.

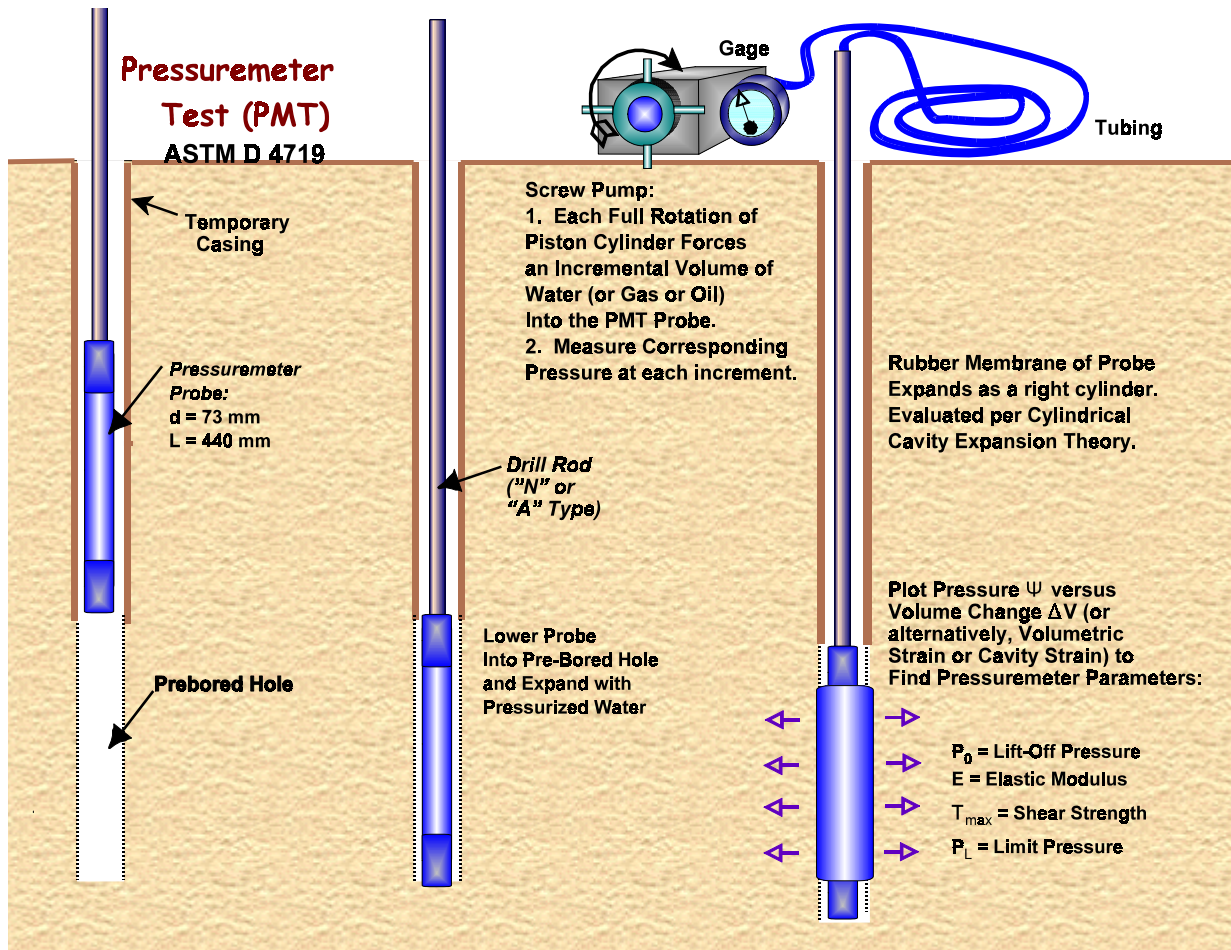


Figure 5-18. Test Procedure and Conduct of the Pre-Bored Type (Menard) Pressuremeter Test.

Procedures for the MPMT, SBP, PIP, and CPMT are similar, once the probe has been installed to the desired test depth. Often, a partial unload-reload sequence is performed during the test loading to define a pseudo-elastic response and corresponding Young's modulus ( $E_{ur}$ ).

The different components of the pressuremeter equipment are shown in Figure 5-18 including: pressure gage readout panel, inflatable Menard-type probes, self-boring Cambridge probe, cutter teeth on SBP, monocell (Texam) probe, and hydraulic jack. Simple commercial systems (Texam, Oyo, and Pencil) are now available that include the a monocell probe with a displacement-type screw pump for inflation. In soil, pressurized water is used for inflating the monocell probes, whereas air pressure is often employed in computerized pressuremeter systems such as the self-boring unit and cone pressuremeter.



**Figure 5-19. Photos of Pressuremeter Equipment, including Menard-type pressure panel, SBP probe, SBP cutter teeth, hydraulic jack, and monocell-type probe.**

The pressuremeter provides four independent measurements with each test:

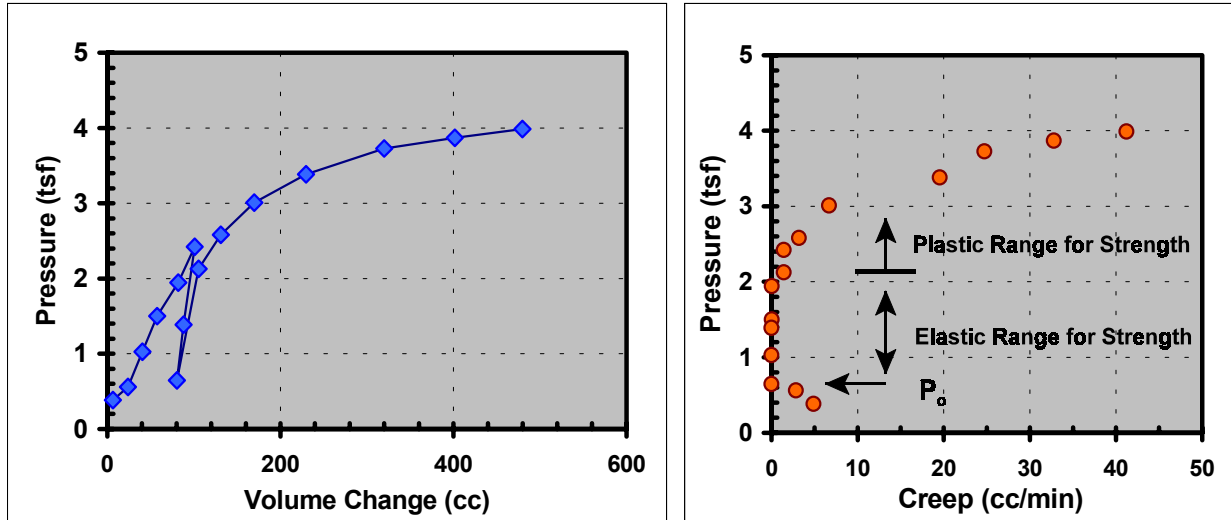
1. Lift off stress, corresponding to the total horizontal stress,  $F_{ho} = P_o$ ;
2. An "elastic" region, interpreted in terms of an equivalent Young's modulus ( $E_{PMT}$ ) during the initial loading ramp. An unload-reload cycle removes some of the disturbance effects and provides a stiffer value of E. Traditionally, the elastic modulus is calculated from:

$$E_{PMT} = 2(1+\nu) \left( \frac{V}{V_0} - 1 \right) P \quad (5-17)$$

where  $V = V_0 + \Delta V$  = current volume of probe,  $V_0$  = initial probe volume,  $\Delta P$  = change in pressure in elastic region,  $\Delta V$  = measured change in volume, and  $\nu$  = Poisson's ratio. Alternative procedures are available to directly interpret the shear modulus (G), as given in Clark (1989).

3. A "plastic" region, corresponding to the shear strength (i.e., an undrained shear strength,  $s_{uPMT}$  for clays and silts; or an effective friction angle  $\phi$  for sands).
4. Limit pressure,  $P_L$  (related to a measure of bearing capacity) which is an extrapolated value of pressure where the probe volume equals twice the initial volume ( $V = 2V_0$ ). This is analogous to  $\Delta V = V_0$ . Several graphical methods are proposed to determine  $P_L$  from measured test data. One common extrapolation approach involves a log-log plot of pressure vs. volumetric strain ( $\Delta V/V_0$ ) and when  $\log(\Delta V/V_0) = 0$ , then  $P = P_L$ .

Figure 5-19 shows a representative curve of pressure versus volume from a PMT in Utah. The recompression, pseudo-elastic, and plastic regions are indicated, as are the corresponding interpreted values of parameters.



**Figure 5-20. Menard-type Pressuremeter Results for Utah DOT Project.**

The conduct of the test permits the direct use of cylindrical cavity expansion (CEE) theory. For the simple case of undrained loading, CCE gives:

$$P_L = P_o + s_u [\ln(G/s_u) + 1] \quad (5-18)$$

so that all four measurements are interrelated by this simple expression. Moreover, the zone of soil affected by this expansion can be related to the soil rigidity index ( $I_R = G/s_u$ ). Here, the size of the region that is plasticized by the failure is represented by a large cylinder of radius  $r_p$  which is calculated from:

$$r_p = r_o \sqrt{I_R} \quad (5-19)$$

where  $r_o$  = initial radius of the probe. Additional details on calibration, procedures, and interpretation for the PMT are given in Baguelin, et al. (1978), Briaud (1989), and Clarke (1995).

## 5.6 SPECIALIZED PROBES AND IN-SITU TESTS

In addition to the common in-situ tests, there are many novel and innovative tests for special applications or needs. These are discussed elsewhere (Jamiolkowski, et al. 1985; Robertson, 1986) and include the Large Penetration Test (LPT) which is similar to the SPT, yet larger size for use in gravelly soils. The Becker Penetration Test (BPT) is essentially an instrumented steel pipe pile that is used to investigate deposits of gravels to cobbles. A number of tests attempt to directly measure the in-situ lateral stress state (i.e.,  $K_o$ ) including the Iowa stepped blade (ISB), push-in spade cells and total stress cells (TSC), and hydraulic fracturing method (HF) that is used extensively in rock mechanics. The borehole shear test (BST) is in essence a downhole direct shear test that applies normal stresses to platens and then measures the shearing resistance to pullout. The BST intends to determine  $cf$  and  $Nr$  in the field, although considerations of excess porewater pressures may be necessary in certain geologic formations. The plate load test (PLT) mimics a small shallow foundation while the screw plate load test (SPLT) consists of a downhole circular plate that is inserted at the bottom of a boring and loaded vertically to evaluate the stress-displacement characteristics of soil at depth.

## 5.7 GEOPHYSICAL METHODS

There are several kinds of geophysical tests that can be used for stratigraphic profiling and delineation of subsurface geometries. These include the measurement of mechanical waves (seismic refraction surveys, crosshole, downhole, and spectral analysis of surface wave tests), as well as electromagnetic techniques (resistivity, EM, magnetometer, and radar). Mechanical waves are additionally useful for the determination of elastic properties of subsurface media, primarily the small-strain shear modulus. Electromagnetic methods can help locate anomalous regions such as underground cavities, buried objects, and utility lines. The geophysical tests do not alter the soil conditions and therefore classify as *nondestructive*, and several are performed at the surface level (termed *non-invasive*).

### ADVANTAGES OF GEOPHYSICS

- Nondestructive and/or non-invasive
- Fast and economical testing
- Theoretical basis for interpretation
- Applicable to soils and rocks

### DISADVANTAGES OF GEOPHYSICS

- No samples or direct physical penetration
- Models assumed for interpretation
- Affected by cemented layers or inclusions.
- Results influenced by water, clay, & depth.

### 5.7.1 MECHANICAL WAVES

Geophysical mechanical wave techniques utilize the propagation of waves at their characteristic velocities for determining layering, elastic stiffnesses, and damping parameters. These tests are usually conducted at very small strain levels ( $\epsilon < 10^{-3}$  percent) and thus truly contained within the elastic region of soils. There are four basic waveforms generated within a semi-infinite elastic halfspace: *compression* (or P-waves), *shear* (or S-waves), *surface* or *Rayleigh* (R-waves), and *Love* waves (L-waves). The P- and S-waves are termed body waves and the most commonly-utilized in geotechnical site characterization (Woods, 1978). The other two types are special types of hybrid compression/shear waves that occur at the free boundary of the ground surface (R) and soil layer interfaces (L). Herein, we shall discuss methods of determining the P- and S-waves.

The compression wave ( $V_p$ ) is the fastest wave and moves as an expanding spherical front that emanates from the source. The amplitude of the compression wave is optimized if the source is a large impact-type (falling weight) or caused by explosive means (blasting). Magnitudes of P-waves for soils are in the typical range of 400 m/s  $\#$   $V_p$   $\#$  2500 m/s, whereas rocks may exhibit P-waves between 2000 and 7000 m/s, depending upon the degree of weathering and fracturing. Figure 5-20 indicates representative values for different geomaterials. Since water has a compression wave velocity of about 1500 m/s, measurements of  $V_p$  for soils below the groundwater can become difficult and unreliable.

The shear wave ( $V_s$ ) is the second fastest wave and expands as a cylindrical front having localized motion perpendicular to the direction of travel. Thus, one can polarize the wave as vertical (up/down) or horizontal (side to side). Since water cannot sustain shear forces, it has no shear wave and therefore does not interfere with  $V_s$  measurements in soils and rocks. S-wave velocities of soil are generally between 100 m/s  $\#$   $V_s$   $\#$  600 m/s, although soft peats and organic clays may have lower velocities. Representative values are presented in Figure 5-21. In geomechanics, the shear wave is the most important wave-type since it relates directly to the shear modulus. Therefore, several different methods have been developed for direct measurement of  $V_s$ , as reviewed by Campanella (1994).

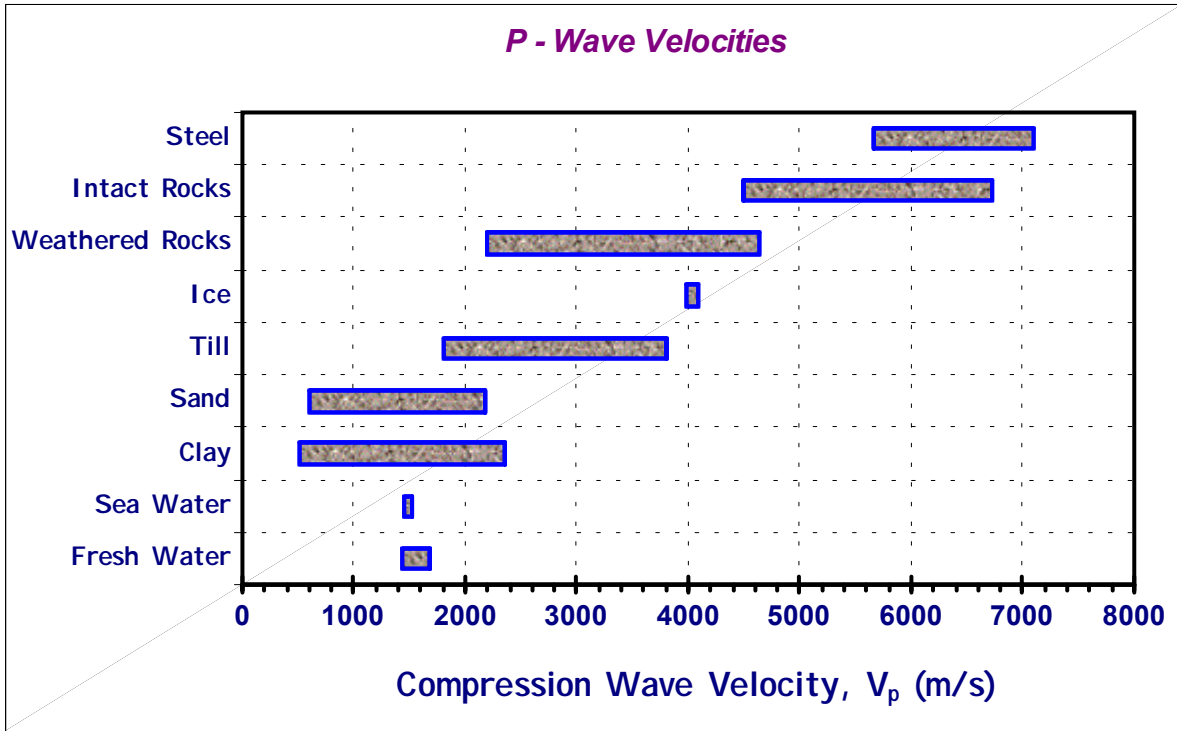


Figure 5-21. Representative Compression Wave Velocities of Various Soil and Rock Materials.

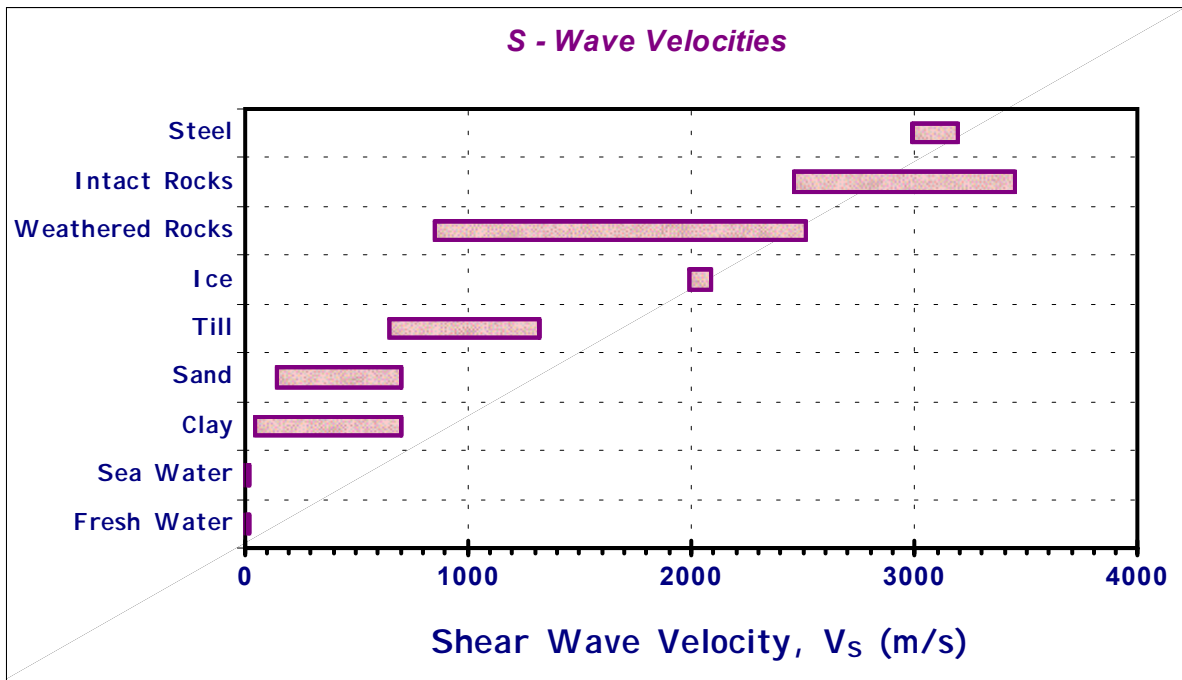


Figure 5-22. Representative Shear Wave Velocities of Various Soil and Rock Materials.



The small-strain shear modulus ( $G_{\max}$  or  $G_0$ ) is evaluated from the expression:

$$G_0 = D_T V_s^2 \quad (5-20)$$

where  $D_T = (\gamma_T/g =$  total mass density of the geomaterial,  $(\gamma_T =$  total unit weight, and  $g = 9.8 \text{ m/sec}^2 =$  gravitational acceleration constant. Note that this value of modulus applies to shear strain levels that are very small (on the order of  $10^{-3}$  percent or less). Most foundation problems (i.e. settlements) and retaining wall situations involve strains at higher levels, on the order of 0.1 percent (Burland, 1989) and would therefore require a modulus reduction factor. In addition to static (monotonic) loading, the  $G_0$  is useful in assessing ground motions during seismic site amplification and dynamically-loaded foundations.

### 5.7.2 Seismic Refraction (SR)

*Seismic refraction* is generally used for determining the depth to very hard layers, such as bedrock. The seismic refraction method is performed according to ASTM D 5777 procedures and involves a mapping of  $V_p$  arrivals using a linear array of geophones across the site, as illustrated in Figures 5-22 and 5-23 for a two-layer stratification. In fact, a single geophone system can be used by moving the geophone position and repeating the source event. In the SR method, the upper layer velocity must be less than the velocity of the lower layer. An impact on a metal plate serves as a source rich in P-wave energy. Initially, the P-waves travel solely through the soil to arrive at geophones located away from the source. At some critical distance from the source, the P-wave can actually travel through soil-underlying rock-soil to arrive at the geophone and make a mark on the oscilloscope. This critical distance ( $x_c$ ) is used in the calculation of depth to rock. The SR data can also be useful to determine the degree of rippability of different rock materials using heavy construction equipment. Most recently, with improved electronics, the shear wave profiles may also be determined by SR.

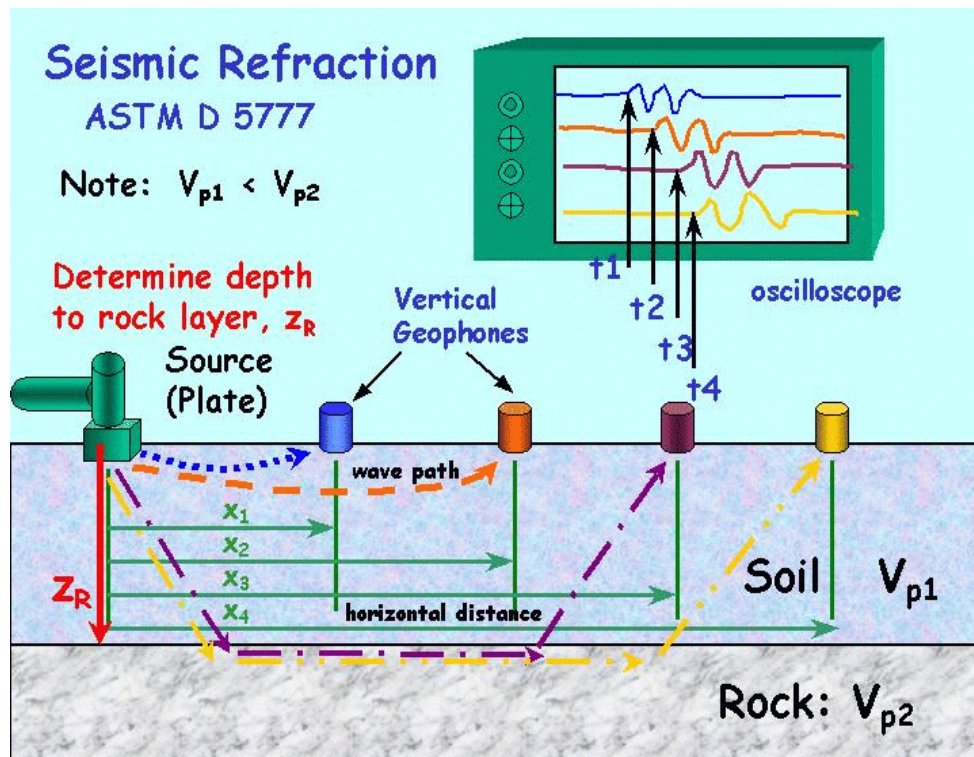


Figure 5-23. Field Setup & Procedures for Seismic Refraction Method.

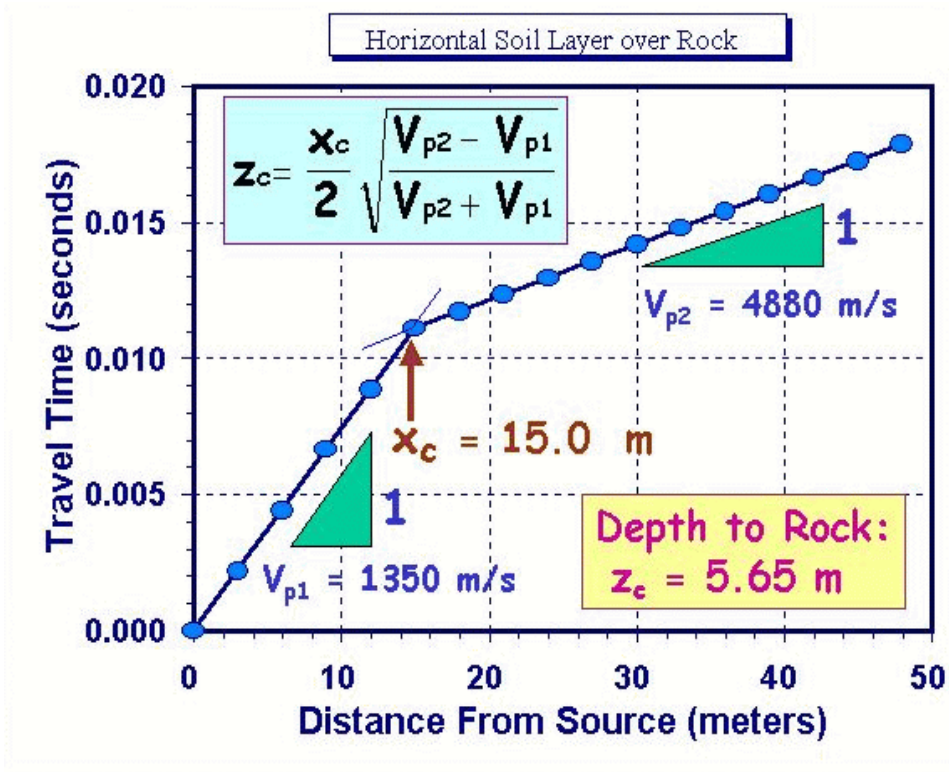
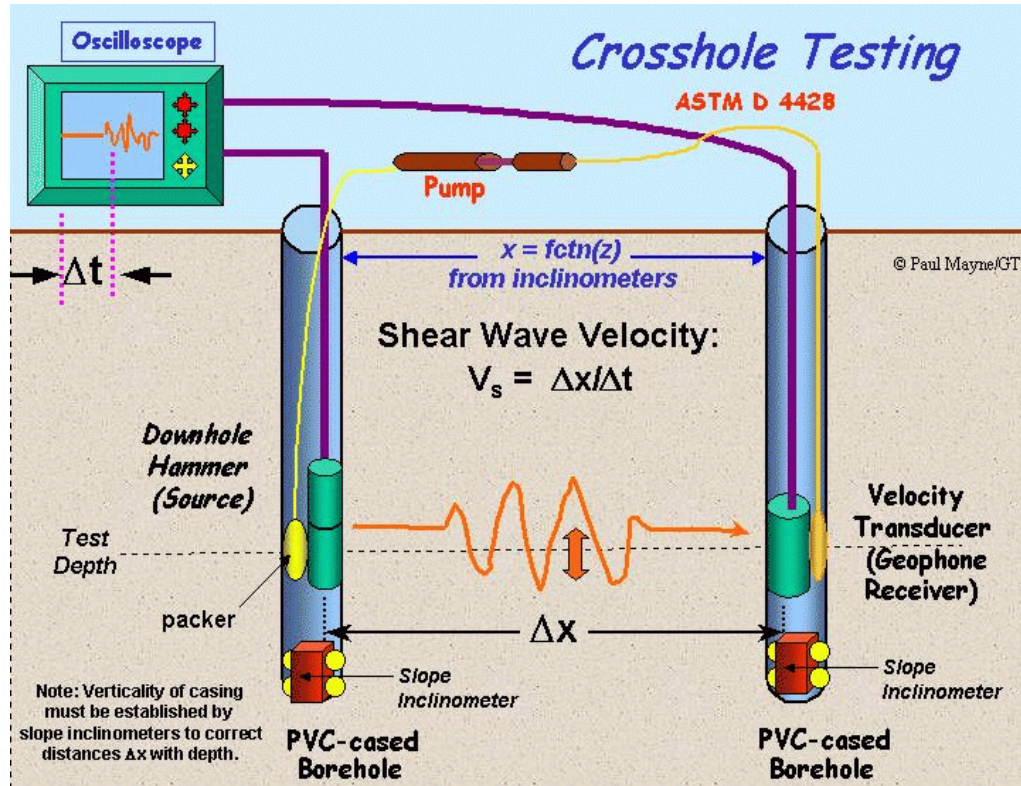


Figure 5-24. Data Reduction of SR Measurements to Determine Depth to Hard Layer.

### 5.7.3 Crosshole Tests (CHT)

*Crosshole seismic surveys* are used for determining profiles of  $V_p$  and  $V_s$  with depth per ASTM D 4428. The crosshole testing (CHT) involves the use of a downhole hammer and one or more downhole vertical geophones in an horizontal array of two or three boreholes spaced about 3 to 6 meters apart to determine the travel times of different strata (Hoar & Stokoe, 1978). A simple CHT setup using direct arrival measurements and two boreholes is depicted in Figure 5-24. The boreholes are most often cased with plastic pipe and grouted in place. After setup and curing of the grout, the borehole verticality must be checked with an inclinometer to determine changes in horizontal distances with depth, particularly if the investigations extends to depths exceeding 15 m. Special care must be exercised during testing to assure good coupling of the geophone receivers with the surrounding soil medium. Usually, inflatable packers or spring-loaded clamps are employed to couple the geophone to the sides of the plastic casing.

A special downhole hammer is preferably used to generate a vertically-polarized horizontally-propagating shear wave. An “up” strike generates a wave that is a mirror image of a “down” strike wave. The test is advantageous in that it may be conducted to great depths of up to 300 meters or more. On the other hand, there is considerable expense in pre-establishing the drilled boreholes & grouted casing, waiting for curing, inclinometer readings, and performing of the geophysical tests. A more rapid procedure is to drill the source hole to each successive test depth, insert a split spoon sampler and strike the drill rod at the surface with a trigger hammer. The disadvantage of this procedure is the absence of an “up” striking providing somewhat greater difficulty in distinguishing the initiation of each wave signal.



**Figure 5-25. Setup and Data Reduction Procedures for Crosshole Seismic Test.**

Since the P-wave arrives first, its trace is already recorded on the oscilloscope or analyzer screen. Therefore, the arrival of the S-wave is often masked because its waveform comes later. It is desirable to use a source rich in shear to increase the amplitude of the shear wave and help delineate its arrival. With reverse polarization, filtering, and signal enhancement, the S-wave signal can be easily distinguished.

#### 5.7.4 Downhole Tests (DHT)

*Downhole surveys* can be performed using only one cased borehole. Here, S-waves are propagated down to the geophone from a stationary surface point. No inclinometer survey is needed as the vertical path distance (R) is calculated strongly on depth. In the DHT, a horizontal plank at the surface is statically loaded by a vehicle wheel (to increase normal stress) and struck lengthwise to provide an excellent shear wave source, as indicated in Figure 5-25. The orientation of the axis of the downhole geophone must be parallel with the horizontal plank (because shear waves are polarized and directional). The results are paired for successive events (generally at 1-m depth intervals) and the corresponding shear wave at mid-interval is calculated as  $V_s = R/t$ , where R = the hypotenuse distance from plank to geophone and t = arrival time of the shear wave. Added accuracy is obtained by conducting both right and left strikes for same depth and superimposing the mirrored recordings to follow the crossover (Campanella, 1994).

A recent version of the downhole method is the seismic cone penetration test (SCPT) with an accelerometer located within the penetrometer. In this manner, no borehole is needed beforehand. Figure 5-26 shows the summary of shear wave trains obtained at each 1-m intervals during downhole testing by SCPTu at Mud Island in downtown Memphis/TN.

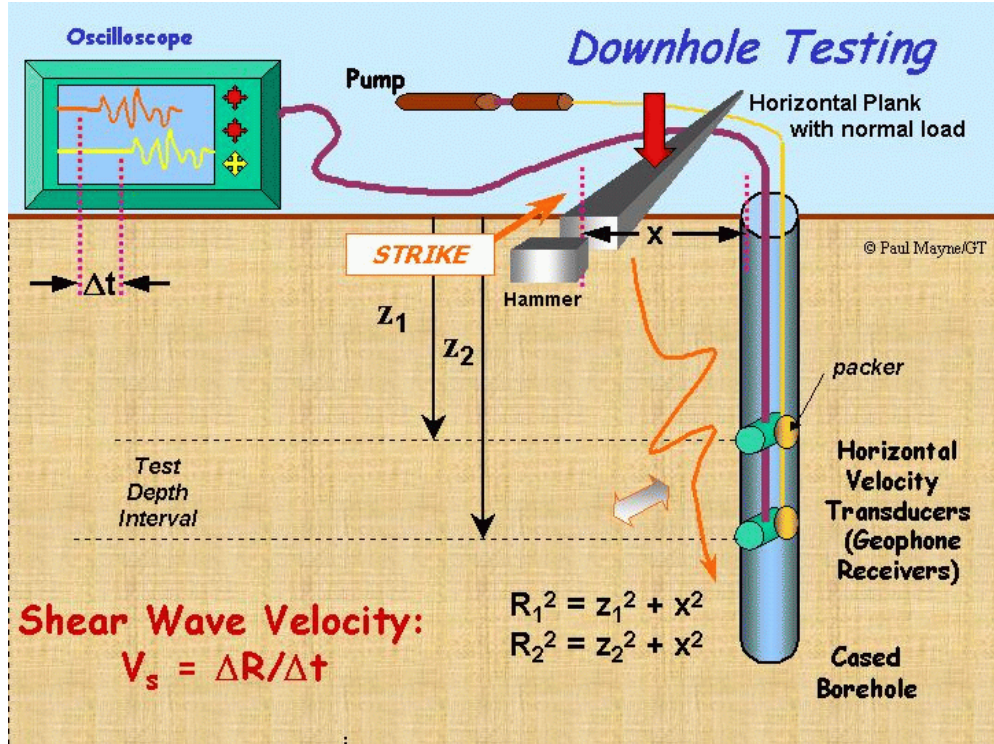


Figure 5-26. Setup and Data Reduction Procedures for Conducting a Downhole Seismic Survey.

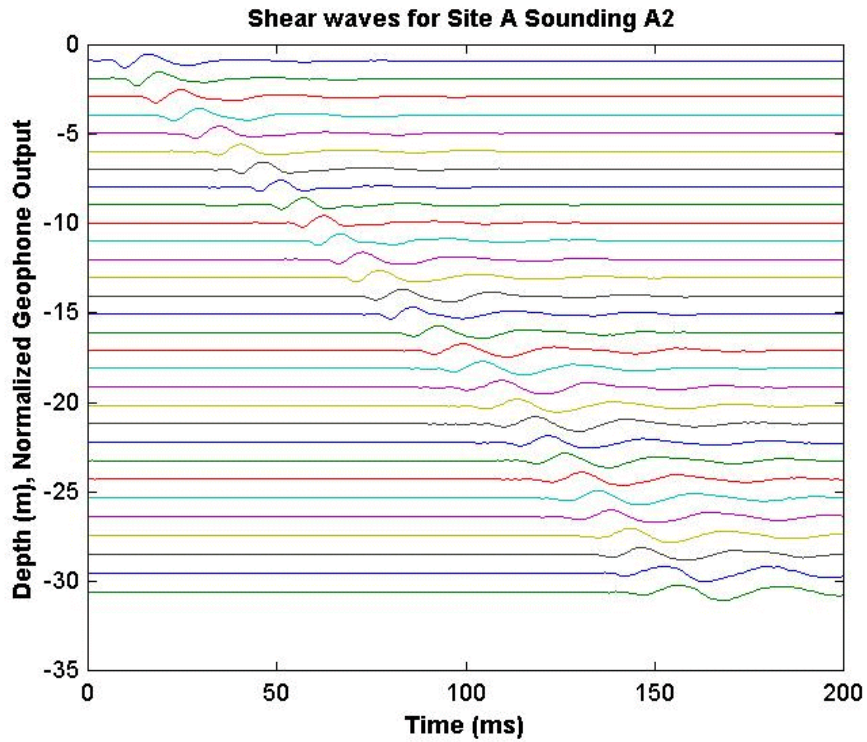
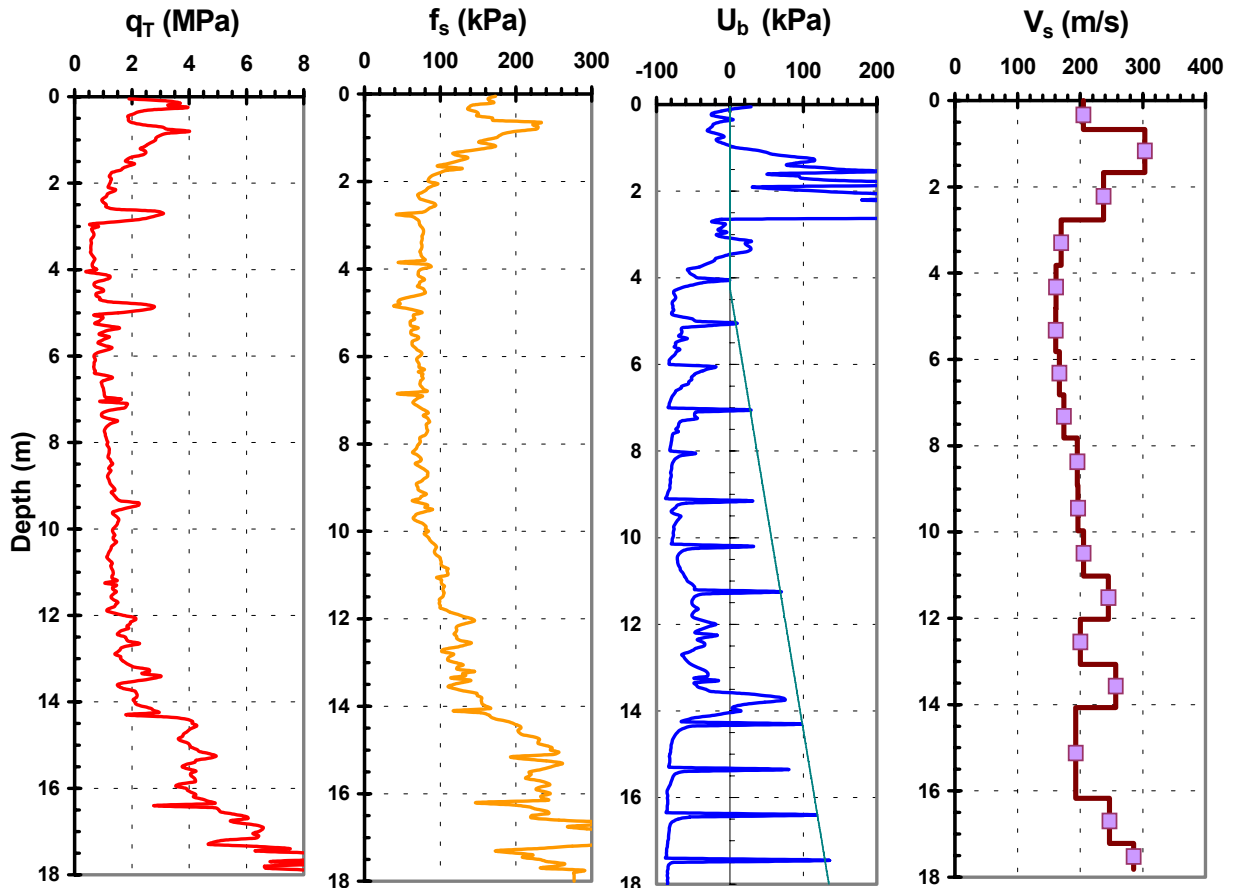


Figure 5-27. Summary Shear Wave Trains from Downhole Tests at Mud Island, Memphis, TN.

The seismic cone is a particularly versatile tool as it is a hybrid of geotechnical penetration coupled with downhole geophysical measurements (Campanella, 1994). The seismic piezocone penetration test (SCPTu) is therefore an economical and expedient means for geotechnical site characterization as it provides four independent readings with depth from a single sounding. Detailed information is obtained about the subsurface stratigraphy, soil types, and responses at complete opposite ends of the stress-strain curve. The CPT measurements are taken continuously with depth and downhole shear wave surveys are normally conducted at each rod change (generally 1-meter intervals). The penetration data ( $q_t$ ,  $f_s$ ,  $u_b$ ) reflect failure states of stress, whereas the shear wave ( $V_s$ ) provides the nondestructive response that corresponds to the small-strain stiffness. Taken together, an entire stress-strain-strength representation can be derived for all depths in the soil profile (Mayne, 2001).

Illustrative results from a SCPTu sounding in residual silts and sands of the Piedmont geology are shown in Figure 5-27. In addition to the continuous readings taken for the CPT portion, the porewater pressures were allowed to dissipate to equilibrium at each rod break. These dissipation phases provide information about the flow characteristics of the soil (namely, coefficient of consolidation and permeability), as discussed further in Chapter 6.



**Figure 5-28. Results of Seismic Piezocone Sounding in Residual Soils in Coweta County, Georgia showing four independent readings with depth.** Note: Penetration porewater pressures allowed to dissipate at each rod break.

### 5.7.5 Surface Waves

The *spectral analysis of surface waves* (SASW) is useful for developing profiles of shear wave velocity with depth. A pair of geophones is situated on the ground surface in linear array with a source. Either a transient force or variable vibrating mass is used to generate surface wave disturbances. The geophones are repositioned at varying distances from the source to develop a dispersion curve (see Figures 5-28 and 5-29). The SASW method utilizes the fact that surface waves (or Rayleigh waves) propagate to depths that are proportional to their wavelength. Thus, a full range of frequencies, or wavelengths, is examined to decipher the  $V_s$  profile through a complex numerical *inversion*. An advantage here is that SASW surveys require no borehole and are therefore noninvasive.

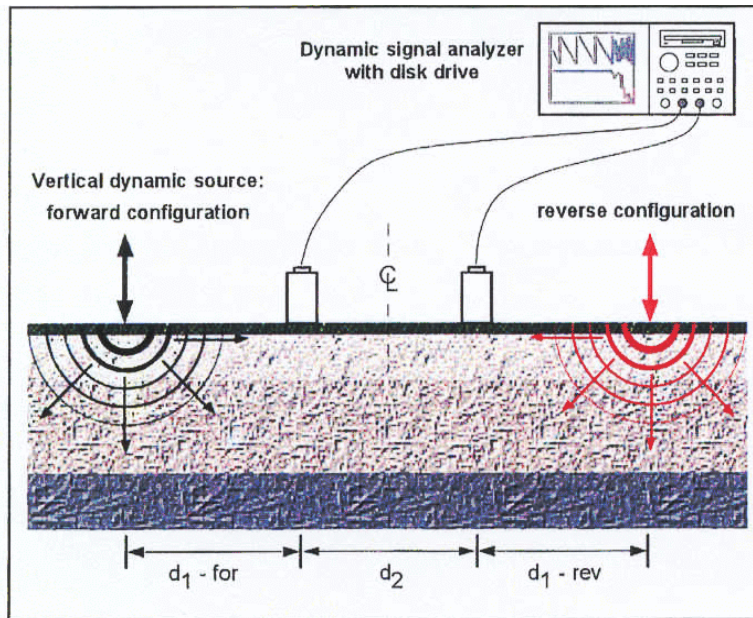
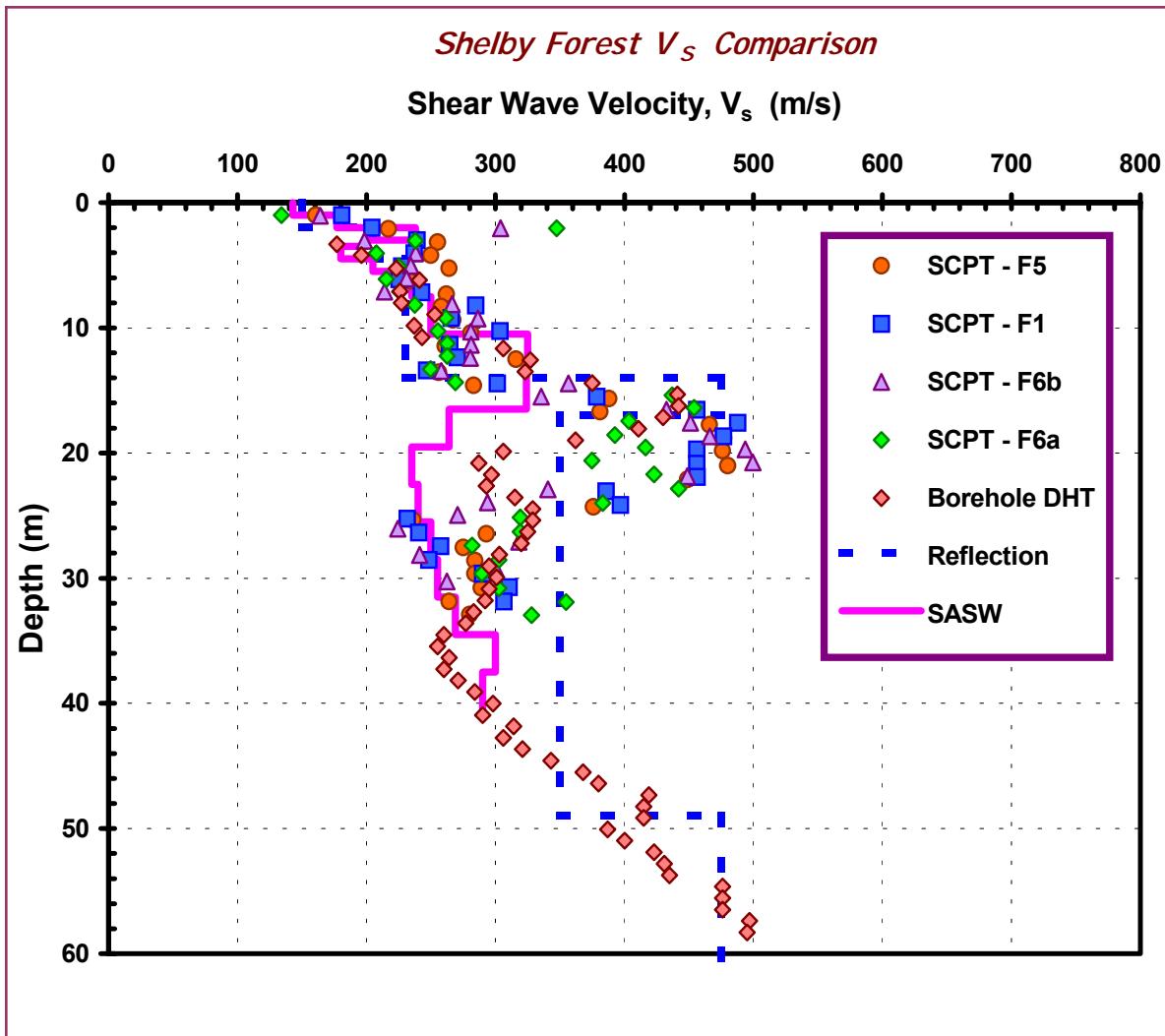


Figure 5-29. Field Setup for Conducting Spectral Analysis of Surface Waves (SASW).



Figure 5-30. Spectrum Analyzer and Data Logging Equipment for SASW.



**Figure 5-31. Comparison of Shear Wave Profiles from Different Geophysical Techniques.**

A comparison of results of shear wave velocity measurements from different geophysical methods are presented in Figure 5-30 in aeolian and sedimentary soils at a USGS test site north of Memphis, TN. The methods include conventional downhole performed in a cased borehole (DHT), several sets of seismic piezocone soundings (SCPTu), spectral analysis of surface waves (SASW), as well as a new research method using a reflection-based evaluation. In the SASW approach, the layering profile depends on the actual penetration of the surface waves, usually assumed to be reach a depth approximately equal to one-third the wavelength and depends on the frequency components. Overall, the four methods give reasonable agreement in their  $V_s$  profiles.

In terms of practice, the downhole test (DHT) provides direct reliable measurements of  $V_s$  that are comparable to CHT results, yet at considerably less expense. For soil profiles, the DHT is facilitated by the SCPT because no site preparation of cased boreholes is needed beforehand. For S-wave profiling in weathered rocks and landfills, the SASW is advantageous, as no penetration of the medium is needed.

### 5.7.6 Electromagnetic Wave Methods

Electromagnetic methods include the measurement of electrical and magnetic properties of the ground, such as resistivity, conductivity (reciprocal of resistivity), magnetic fields, dielectric characteristics, and permittivity. Detailed descriptions of these properties and their measurements are provided by Santamarina, et al. (2001). The wave frequencies can be varied greatly from as low as 10 Hz to as much as  $10^{22}$  Hz, with corresponding wavelengths ranging from  $10^7$  m down to  $10^{-14}$  m. In terms of increasing frequency, the electromagnetic waveforms include: radio, microwaves, infrared, visible, ultraviolet, x-ray, and gamma rays. Surface mapping of electromagnetic waves over a gridded coverage can provide relative or absolute information about the surface conditions, as these waves penetrate the ground.

Several electromagnetic wave techniques are available commercially for noninvasive imaging and mapping of the ground. These can provide approximate locations of buried anomalies such as underground utility lines, wells, caves, sinkholes, and other features. The methods include :

- ' Ground Penetrating Radar (GPR)
- ' Electrical Resistivity Surveys (ER)
- ' Electromagnetic Conductivity (EM)
- ' Magnetometer Surveys (MS)
- ' Resistivity Piezocone (RCPTu)

With recent improvements in electronics hardware, filtering, signal processing, inversion, micro-electronics, and software, the use & interpretation of these electromechanical wave methods has become easy, fast, and economical. A brief description of these techniques is given here with illustrative examples and more detailed information can be found at the websites in Appendix B (page B-3). As the commercial equipment comes with its data-reduction software, only final results of the measurements are shown here for sake of brevity.

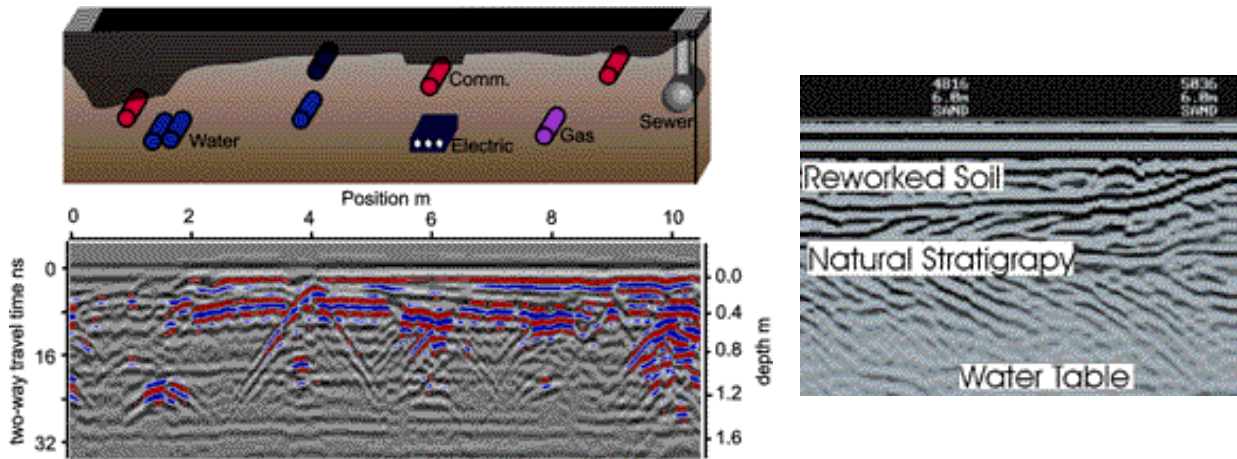
#### ***Ground Penetrating Radar (GPR)***

Short impulses of a high-frequency electromagnetic wave are transmitted into the ground using an pair of transmitting & receiving antennae. The GPR surveys are made by gridding the site and positioning or pulling the tracking cart across the ground surface. Changes in the dielectric properties of the soil (i.e., permittivity) reflect relative changes in the subsurface environment. The EM frequency and electrical conductivity of the ground control the depth of penetration of the GPR survey. Many commercial systems come with several sets of paired antennas to allow variable depths of exploration, as well as accommodate different types of ground (Figure 5-31). A recent development (GeoRadar) uses a variably-sweeping frequency to capture data at a variety of depths and soil types.

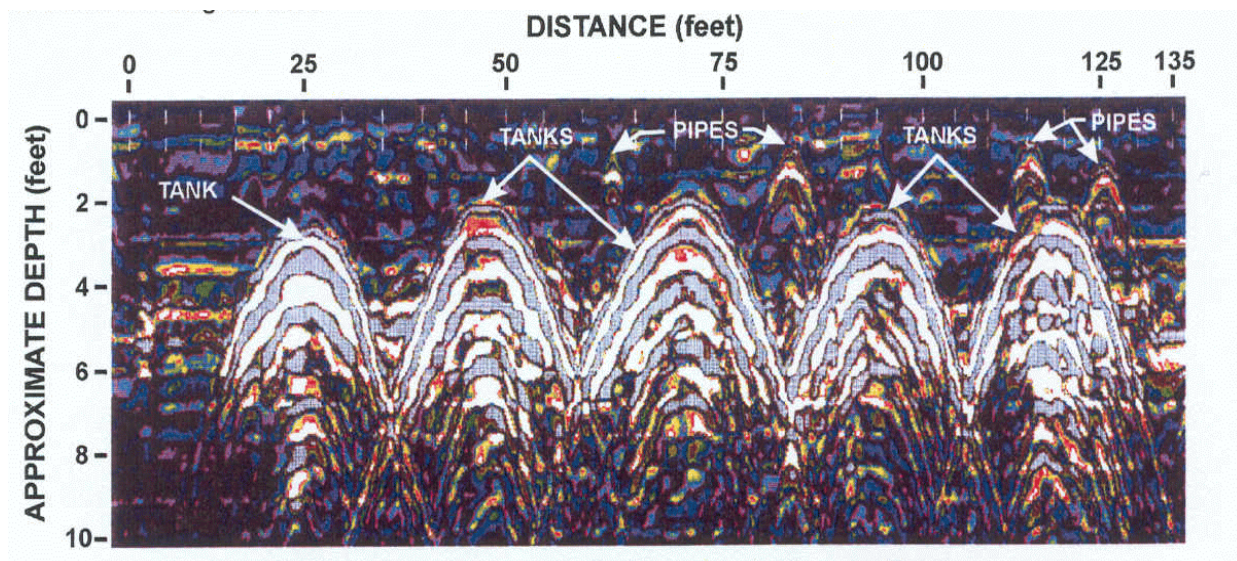


**Figure 5-32. Ground Penetrating Radar (GPR) Equipment from Xadar, GeoVision, and EKKO Sensors & Software.**





**Figure 5-33. GPR Results: (a) Buried Utility Locations and (b) Soil Profile of Fill over Soil**  
 (from EKKO Sensors & Software: [www.senssoft.on.ca](http://www.senssoft.on.ca))



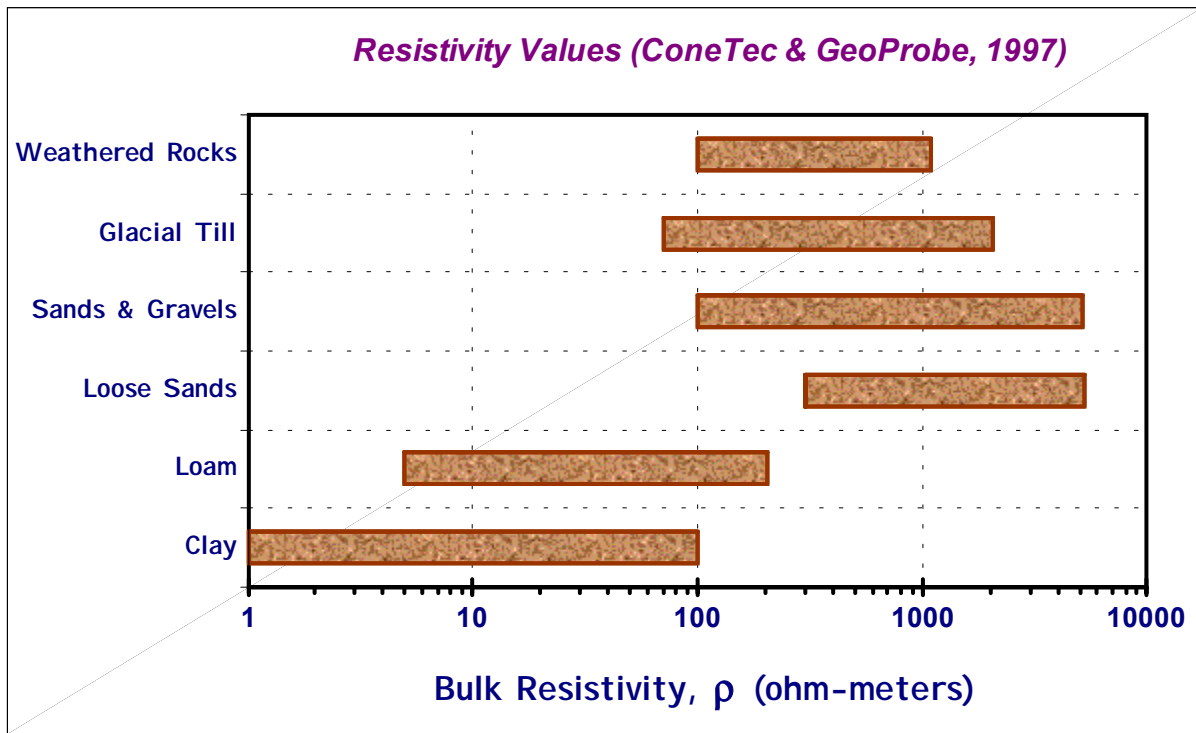
**Figure 5-33 (c) GPR Locating of Underground Tanks and Pipes (GeoVision/Geometrics).**

The GPR surveys provide a quick imaging of the subsurface conditions, leaving everything virtually unchanged and undisturbed. This can be a valuable tool used to define subsoil strata, underground tanks, buried pipes, cables, as well as to characterize archaeological sites before soil borings, probes, or excavation operations. It can also be utilized to map reinforcing steel in concrete decks, floors, and walls. Several illustrative examples of GPR surveys are shown in Figure 5-32. The GPR surveys are particularly successful in deposits of dry sands with depths of penetration up to 20 m or more (60 feet), whereas in wet saturated clays, GPR is limited to shallow depths of only 3 to 6 meters (10 to 20 feet).

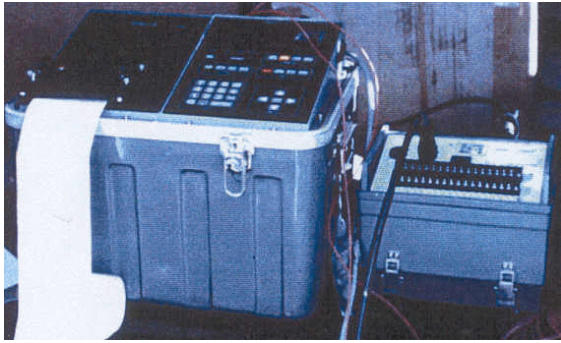
### ***Electrical Resistivity Survey (ER) or Surface Resistivity Method***

Resistivity is a fundamental electrical property of geomaterials and can be used to evaluate soil types and variations of pore fluid and changes in subsurface media (Santamarina et al., 2001). The resistivity ( $D_R$ ) is measured in ohm-meters and is the reciprocal of electrical conductivity ( $k_E = 1/D_R$ ). Conductivity is reported in siemens per meter (S/m), where S = amps/volts. Using pairs or arrays of electrodes embedded into the surface of the ground, a surface resistivity survey can be conducted to measure the difference in electrical potential of an applied current across a site. The spacing of the electrodes governs the depth of penetration by the resistivity method and the interpretation is affected by the type of array used (Wenner, dipole-dipole, Schlumberger). The entire site is gridded and subjected to parallel arrays of SR-surveys if a complete imaging map is desired. Mapping allows for relative variations of soil types to be discerned, as well as unusual features.

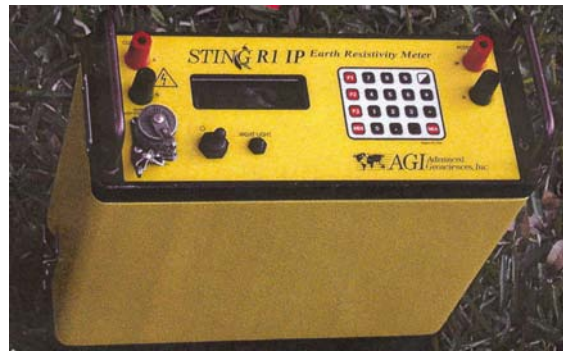
In general, resistivity values increase with soil grain size. Figure 5-33 presents some illustrative values of bulk resistivity for different soil and rock types. This resistivity technique has been used to map faults, karstic features, stratigraphy, contamination plumes and buried objects, and other uses. Figure 5-34 shows the field resistivity equipment and illustrative results from an ER survey in karst to detect caves and sinkholes. Downhole resistivity surveys can also be performed using electronic probes that are lowered vertically down boreholes, or are direct-push placed. The latter can be accomplished using a resistivity module that trails a cone penetrometer, termed a resistivity piezocone (RCPTu). Downhole resistivity surveys are particularly advantageous in distinguishing the interface between upper freshwater and lower saltwater zones in coastal regions. They are also used in detecting fluid contaminants during geoenvironmental investigations.



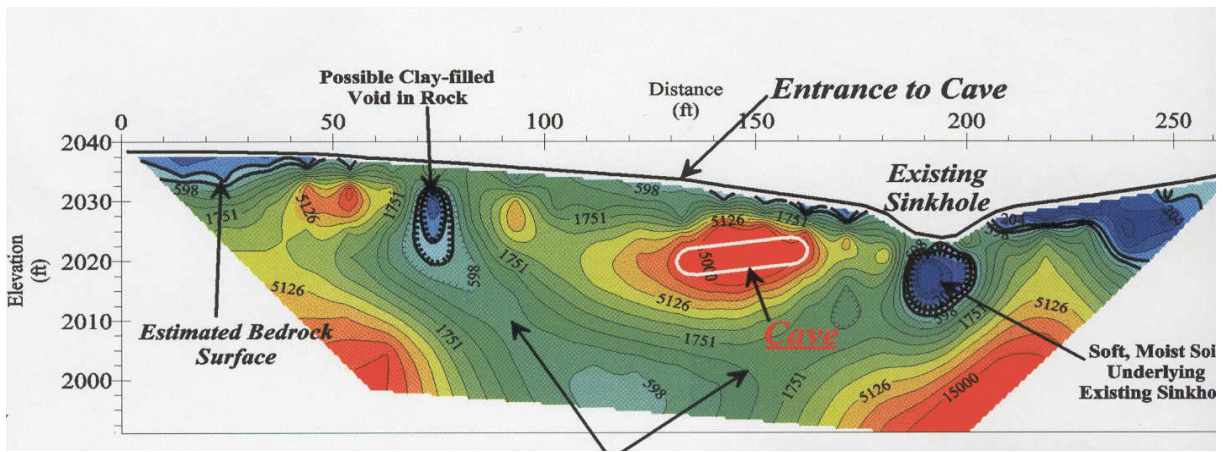
**Figure 5-34. Representative Values of Resistivity for Different Geomaterials.**



(a)



(b)

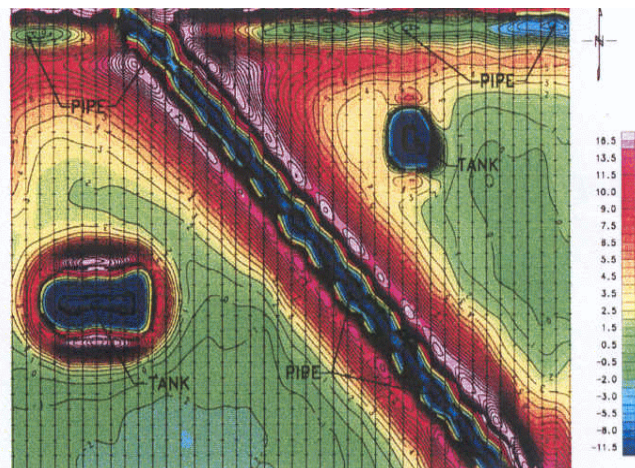


(c)

**Figure 5-35. Electrical Resistivity Equipment and Results: (a) Oyo System; (b) Advanced Geosciences Inc.; (c) Two-Dimensional Cross-Section Resistivity Profile for Detection of Sinkholes and Caves in Limestone (from Schnabel Engineering Associates).**

### *Electromagnetic Techniques*

Several types of electromagnetic (EM) methods can be used to image the ground and buried features, including: induction, frequency domain, low frequency, and time domain systems. This is best handled by mapping the entire site area to show relative variations and changes. The EM methods are excellent at tracking buried metal objects and well-know in the utility locator industry. They can also be used to detect buried tanks, map geologic units, and groundwater contaminants, generally best within the upper one or two meters, yet extend to depths of 5 m or more.



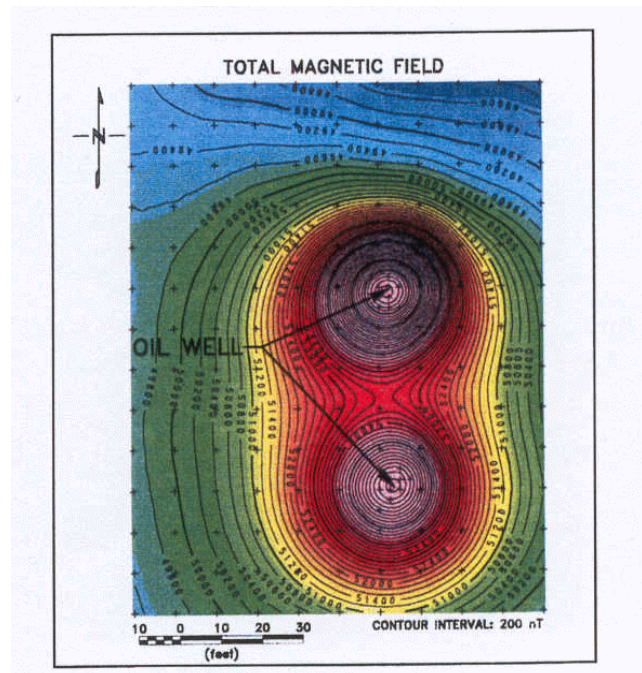
**Figure 5-36. EM Survey to Detect Underground Storage Tanks (Geonics EM-31 Survey by GeoVision).**

## Magnetic Surveys

The earth's magnetic field, as well as local anomalies and variations within the ground, can be mapped with magnetometer equipment at the ground surface. The relative readings can be used to develop color-enhanced maps that show the changes in total magnetic field across the property. Either 2-d magnetic surveys (MS) or full areal grids can be performed to provide full coverage of buried metal objects and underground features. Figure 5-32 shows results from magnetometer surveys for locating abandoned oil wells.

Additional details on SR, EM, GPR, and MS can be found in Greenhouse, et al. (1998) and the geophysical information portion of the Geoforum website at:

<http://www.geoforum.com/info/geophysical/>



**Figure 5-37. Magnetometer Survey Results (Geometrics).**

## 5.8 SUMMARY ON IN-SITU GEOTECHNICAL & GEOPHYSICAL METHODS

In-situ physical and geophysical testing provide direct information concerning the subsurface conditions, geostatigraphy, and engineering properties prior to design, bids, and construction on the ground. The electromagnetic wave geophysics (GPR, EM, ER, MS) are non-invasive and non-destructive. By mapping the entire surface area of the site, these techniques are useful in imaging the generalized subsurface conditions and detecting utilities, hidden objects, boulders, and other anomalies. The mapping is conducted on a relative scale of measurements that reflect changes across the property. They may aid in finding underground cavities, caves, sinkholes, and erosional features in limestone and dolostone terrain. In pre-occupied land, they may be used to detect underground utility lines, buried tanks and drums, and objects of environmental concern.

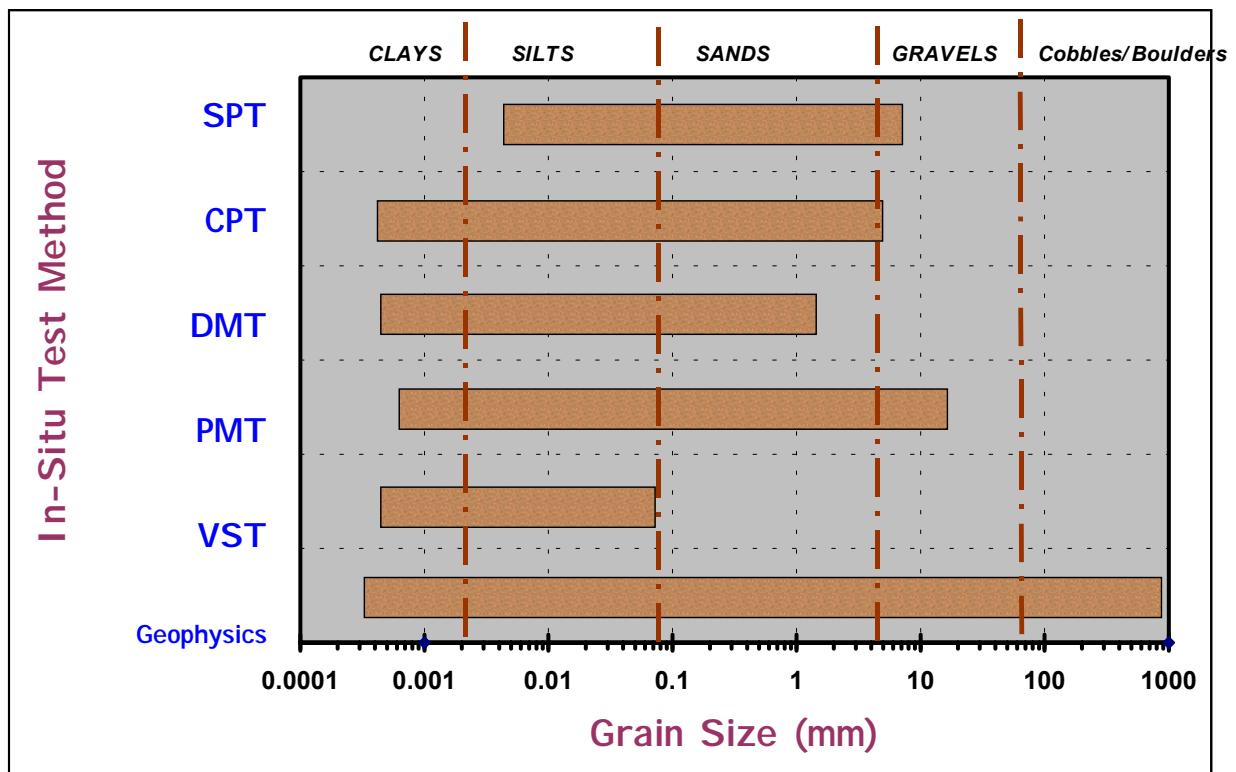
Mechanical wave geophysics (CHT, DHT, SASW, SR) provide important measurements of compression (P), shear (S), and Rayleigh (R) wave velocities that determine geostrata layering and small-strain properties of soil and rock. The SR provides P-wave velocities and SASW obtains S-wave profiles and both are conducted at the surface of the ground and are therefore non-invasive as well as non-destructive. The CHT and DHT require cased boreholes, yet the seismic penetrometer (SCPT) now offers a quick and economical version of DHT for routine application. In geotechnical applications, the shear wave velocity ( $V_s$ ) provides the fundamental measurement of small-strain stiffness, in terms of low-amplitude shear modulus ( $G_0 = D_T V_s^2$ ), where  $D_T$  is the total mass density of the ground. Traditionally, the stiffness from shear wave velocity measurements has been used in site amplification analyses during seismic ground hazard studies and the evaluation of dynamically-loaded foundations supporting machinery, yet in recent findings, this stiffness has been shown of equal importance and relevance to small-strain behavior of static and monotonic loading, including deflections of pile foundations, excavations, and walls, as well as foundation settlement evaluations (Burland, 1989; Tatsuoka & Shibuya, 1992).

In soils, in-situ geotechnical tests include penetration-type (SPT, CPT, CPTu, DMT, CPMT, VST) and probing-type (PMT, SBP) methods to directly obtain the response of the geomaterials under various loading situations and drainage conditions. These tests are complementary and should be used together with geophysics to develop an understanding of the natural soil & rock formations that comprise the project site. The general applicability of the test method depends in part on the geomaterial types encountered during the site investigation, as shown by Table 5.1 below. The relevance of each test also depends on the project type and its requirements. In general, the geophysical methods can also be applied to weathered rock masses and fractured rock formations.

The evaluation of strength, deformation, flow, and time-rate behavior of soil materials can be derived from selected tests or combinations of these test methods (see Chapter 9). Together, information from these tests allow for the rational and economical selection for deciding foundation types for bridges and buildings, safe embankment construction over soft ground, cut angles for adequate slope stability, and lateral support for underground excavations. Notably, hybrids of geotechnical and geophysical devices, such as the seismic piezocone (SCPTu) and seismic dilatometer (SDMT) provide an optimization of data collection within the same sounding, as well as information at both non-destructive small-strain stiffnesses and large-strain strength regions of the material (Mayne, 2001).

**TABLE 5-1.**

**RELEVANCE OF IN-SITU TESTS TO DIFFERENT SOIL TYPES**



[BLANK]

## CHAPTER 6.0

### GROUNDWATER INVESTIGATIONS

#### 6.1 GENERAL

Groundwater conditions and the potential for groundwater seepage are fundamental factors in virtually all geotechnical analyses and design studies. Accordingly, the evaluation of groundwater conditions is a basic element of almost all geotechnical investigation programs. Groundwater investigations are of two types as follows:

- ' Determination of groundwater levels and pressures and
- ' Measurement of the permeability of the subsurface materials.

Determination of groundwater levels and pressures includes measurements of the elevation of the groundwater surface or water table and its variation with the season of the year; the location of perched water tables; the location of aquifers (geological units which yield economically significant amounts of water to a well); and the presence of artesian pressures. Water levels and pressures may be measured in existing wells, in boreholes and in specially-installed observation wells. Piezometers are used where the measurement of the ground water pressures are specifically required (i.e. to determine excess hydrostatic pressures, or the progress of primary consolidation).

Determination of the permeability of soil or rock strata is needed in connection with surface water and groundwater studies involving seepage through earth dams, yield of wells, infiltration, excavations and basements, construction dewatering, contaminant migration from hazardous waste spills, landfill assessment, and other problems involving flow. Permeability is determined by means of various types of seepage, pressure, pumping, and flow tests.

#### 6.2 DETERMINATION OF GROUNDWATER LEVELS AND PRESSURES

Observations of the groundwater level and pressure are an important part of all geotechnical explorations, and the identification of groundwater conditions should receive the same level of care given to soil descriptions and samples. Measurements of water entry during drilling and measurements of the groundwater level at least once following drilling should be considered a minimum effort to obtain water level data, unless alternate methods, such as installation of observation wells, are defined by the geotechnical engineer. Detailed information regarding groundwater observations can be obtained from ASTM D 4750, "Standard Test Method For Determining Subsurface Liquid Levels in a Borehole or Monitoring Well" and ASTM D 5092 "Design and Installation of Groundwater Wells in Aquifers".

##### 6.2.1 Information on Existing Wells

Many states require the drillers of water wells to file logs of the wells. These are good sources of information of the materials encountered and water levels recorded during well installation. The well owners, both public and private, may have records of the water levels after installation which may provide extensive information on fluctuations of the water level. This information may be available at state agencies regulating the drilling and installation of water wells, such as the Department of Transportation, the Department of Natural Resources, State Geologist, Hydrology Departments, and Division of Water Resources.

### **6.2.2 Open Borings**

The water level in open borings should be measured after any prolonged interruption in drilling, at the completion of each boring, and at least 12 hours (preferably 24 hours) after completion of drilling. Additional water level measurements should be obtained at the completion of the field exploration and at other times designated by the engineer. The date and time of each observation should be recorded.

If the borehole has caved, the depth to the collapsed region should be recorded and reported on the boring record as this may have been caused by groundwater conditions. Perhaps, the elevations of the caved depths of certain borings may be consistent with groundwater table elevations at the site and this may become apparent once the subsurface profile is constructed (see Chapter 11).

Drilling mud obscures observations of the groundwater level owing to filter cake action and the higher specific gravity of the drilling mud compared to that of the water. If drilling fluids are used to advance the borings, the drill crew should be instructed to bail the hole prior to making groundwater observations.

### **6.2.3 Observation Wells**

The observation well, also referred to as piezometer, is the fundamental means for measuring water head in an aquifer and for evaluating the performance of dewatering systems. In theory, a “piezometer” measures the pressure in a confined aquifer or at a specific horizon of the geologic profile, while an “observation well” measures the level in a water table aquifer (Powers, 1992). In practice, however, the two terms are at times used interchangeably to describe any device for determining water head.

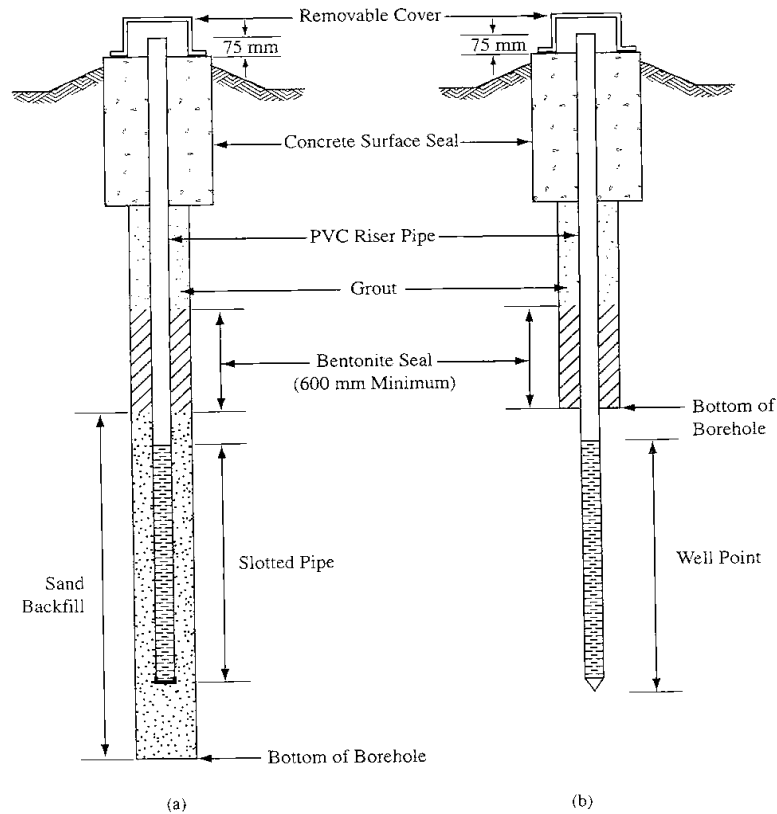
The term “observation well” is applied to any well or drilled hole used for the purpose of long-term studies of groundwater levels and pressures. Existing wells and bore holes in which casing is left in place are often used to observe groundwater levels. These, however, are not considered to be as satisfactory as wells constructed specifically for the purpose. The latter may consist of a standpipe installed in a previously drilled exploratory hole or a hole drilled solely for use as an observation well.

Details of typical observation well installations are shown in Figure 6-1. The simplest type of observation well is formed by a small-diameter polyvinyl chloride (PVC) pipe set in an open hole. The bottom of the pipe is slotted and capped, and the annular space around the slotted pipe is backfilled with clean sand. The area above the sand is sealed with bentonite, and the remaining annulus is filled with grout, concrete, or soil cuttings. A surface seal, which is sloped away from the pipe, is commonly formed with concrete in order to prevent the entrance of surface water. The top of the pipe should also be capped to prevent the entrance of foreign material; a small vent hole should be placed in the top cap. In some localities, regulatory agencies may stipulate the manner for installation and closure of observation wells.

Driven or pushed-in well points are another common type for use in granular soil formations and very soft clay (Figure 6-1b). The well is formed by a stainless steel or brass well point threaded to a galvanized steel pipe (see Dunnycliff, 1988 for equipment variations). In granular soils, an open boring or rotary wash boring is advanced to a point several centimeters above the measurement depth and the well point is driven to the desired depth. A seal is commonly required in the boring above the well point with a surface seal at the ground surface. Note that observation wells may require development (see ASTM D 5092) to minimize the effects of installation, drilling fluids, etc. Minimum pipe diameters should allow introduction of a bailer or other pumping apparatus to remove fine-grained materials in the well to improve the response time.

Local or state jurisdictions may impose specific requirements on “permanent” observation wells, including closure and special reporting of the location and construction that must be considered in the planning and installation. Licensed drillers and special fees also may be required.





**Figure 6-1. Representative Details of Observation Well Installations. (a) Drilled-in-place Stand-Pipe Piezometer, (b) Driven Well Point.**

Piezometers are available in a number of designs. Commonly used piezometers are of the pneumatic and the vibrating wire type. Interested readers are directed to Course Module No. 11 (Instrumentation) or Dunnycliff (1988) for a detailed discussion of the various types of piezometers.

#### 6.2.4 Water Level Measurements

A number of devices have been developed for sensing or measuring the water level in observation wells. Following is a brief presentation of the three common methods that are used to measure the depth to groundwater. In general, common practice is to measure the depth to the water surface using the top of the casing as a reference, with the reference point at a common orientation (often north) marked or notched on the well casing.

## **Chalked Tape**

In this method a short section at the lower end of a metal tape is chalked. The tape with a weight attached to its end is then lowered until the chalked section has passed slightly below the water surface. The depth to the water is determined by subtracting the depth of penetration of the line into water, as measured by the water line in the chalked section, from the total depth from the top of casing. This is probably the most accurate method, and the accuracy is useful in pump tests where very small drawdowns are significant. The method is cumbersome, however, when taking a series of rapid readings, since the tape must be fully removed each time. An enameled tape is not suitable unless it is roughened with sandpaper so it will accept chalk. The weight on the end of the tape should be small in volume so it does not displace enough water to create an error.

## **Tape with a Float**

In this method, a tape with a flat-bottomed float attached to its end is lowered until the float hits the water surface and the tape goes slack. The tape is then lifted until the float is felt to touch the water surface and it is just taut; the depth is then measured. With practice this method can give rough measurements, but its accuracy is poor. A refinement is to mount a heavy whistle, open at the bottom, on a tape. When it sinks in the water, the whistle will give an audible beep as the air within it is displaced.

## **Electric Water-Level Indicator**

This battery operated indicator consists of a weighted electric probe attached to the lower end of a length of electrical cable that is marked at intervals to indicate the depth. When the probe reaches the water a circuit is completed and this is registered by a meter mounted on the cable reel. Various manufacturers produce the instrument, utilizing as the signaling device a neon lamp, a horn, or an ammeter. The electric indicator has the advantage that it may be used in extremely small holes.

The instrument should be ruggedly built, since some degree of rough handling can be expected. The distance markings must be securely fastened to the cable. Some models are available in which the cable itself is manufactured as a measuring tape. The sensing probe should be shielded to prevent shorting out against metal risers. When the water is highly conductive, erratic readings can develop in the moist air above the actual water level. Sometimes careful attention to the intensity of the neon lamp or the pitch of the horn will enable the reader to distinguish the true level. A sensitivity adjustment on the instrument can be useful. If oil or iron sludge has accumulated in the observation well, the electric probe will give unreliable readings.

## **Data Loggers**

When timed and frequent water level measurements are required, as for a pump test or slug test, data loggers are useful. Data loggers are in the form of an electric transducer near the bottom of the well which senses changes in water level as changes in pressure. A data acquisition system is used to acquire and store the readings. A data logger can eliminate the need for onsite technicians on night shifts during an extended field permeability test. A further significant saving is in the technician's time back in the office. The preferred models of the data logger not only record the water level readings but permit the data to be downloaded into a personal computer and, with appropriate software, to be quickly reduced and plotted. These devices are also extremely useful for cases where measurement of artesian pressures is required or where data for tidal corrections during field permeability tests is necessary.

### 6.3 FIELD MEASUREMENT OF PERMEABILITY

The permeability ( $k$ ) is a measure of how easily water and other fluids are transmitted through the geomaterial and thus represents a flow property. In addition to groundwater related issues, it is of particular concern in geoenvironmental problems. The parameter  $k$  is closely related to the coefficient of consolidation ( $c_v$ ) since time rate of settlement is controlled by the permeability. In geotechnical engineering, we designate small  $k$  = coefficient of permeability or hydraulic conductivity (units of cm/sec), which follows Darcy's law:

$$q = k i A \quad (6-1)$$

where  $q$  = flow (cm<sup>3</sup>/sec),  $i = dh/dx$  = hydraulic gradient, and  $A$  = cross-sectional area of flow.

Laboratory permeability tests may be conducted on undisturbed samples of natural soils or rocks, or on reconstituted specimens of soil that will be used as controlled fill in embankments and earthen dams. Field permeability tests may be conducted on natural soils (and rocks) by a number of methods, including simple falling head, packer (pressurized tests), pumping (drawdown), slug tests (dynamic impulse), and dissipation tests. A brief listing of the field permeability methods is given in Table 6-1.

The hydraulic conductivity ( $k$ ) is related to the specific (or absolute) permeability,  $K$  (cm<sup>2</sup>) by:

$$K = k \frac{\gamma_w}{\mu} \quad (6-2)$$

where  $\mu$  = fluid viscosity and  $\gamma_w$  = unit weight of the fluid (i.e., water). For fresh water at  $T = 20^\circ\text{C}$ ,  $\mu = 1.005 \times 10^{-6}$  kN-sec/m<sup>2</sup> and  $\gamma_w = 9.80$  kN/m<sup>3</sup>. Note that  $K$  may be given in units of darcies (1 darcy =  $9.87 \times 10^{-9}$  cm<sup>2</sup>). Also, please note that groundwater hydrologists have confusingly interchanged  $k$  &  $K$  in their nomenclature and this conflict resides within the various ASTM standards. The rate at which water is transmitted through a unit width of an aquifer under a hydraulic gradient  $i = 1$  is defined as the transmissivity ( $T$ ) of the formation, given by:

$$T = k b \quad (6-3)$$

where  $b$  = aquifer thickness.

The coefficient of consolidation ( $c_v$  for vertical direction) is related to the coefficient of permeability by the expression:

$$c_v = k \frac{D_N}{\gamma_w} \quad (6-4)$$

where  $D_N = (1/m_v) =$  constrained modulus obtained from one-dimensional oedometer tests (i.e., in lieu of the well-known  $e$ -log  $F_v$  curve, the constrained modulus is simply  $D = \frac{F_v}{m_v}$ ). In conventional one-

dimensional vertical compression,  $c_v$  is often determined from the time rate of consolidation:

$$c_v = T H^2/t \quad (6-5)$$

where T = time factor (from Terzaghi theory), H = drainage path length, and t = measured time. For field permeability, it may be desirable to distinguish between vertical ( $c_v$ ) and horizontal consolidation ( $c_h$ ).

**TABLE 6-1.**

**FIELD METHODS FOR MEASUREMENT OF PERMEABILITY**

<u>Test Method</u>	<u>Applicable Soils</u>	<u>Reference</u>
Various Field Methods	Soil & Rock Aquifers	ASTM D 4043
Pumping tests	Drawdown in soils	ASTM D 4050
Double-ring infiltrometer	Surface fill soils	ASTM D 3385
Infiltrometer with sealed ring	Surface soils	ASTM D 5093
Various field methods	Soils in vadose zone	ASTM D 5126
Slug tests.	Soils at depth	ASTM D 4044
Hydraulic fracturing	Rock in-situ	ASTM D 4645
Constant head injection	Low-permeability rocks	ASTM D 4630
Pressure pulse technique	Low-permeability rocks	ASTM D 4630
Piezocone dissipation	Low to medium k soils	Houlsby & Teh (1988)
Dilatometer dissipation	Low to medium k soils	Robertson et al. (1988)
Falling head tests	Cased borehole in soils	Lambe & Whitman (1979)

**6.3.1 Seepage Tests**

Seepage tests in boreholes constitute one means of determining the in-situ permeability. They are valuable in the case of materials such as sands or gravels because undisturbed samples of these materials for laboratory permeability testing are difficult or impossible to obtain. Three types of tests are in common use: falling head, rising head, and constant water level methods.

In general, either the rising or the falling level methods should be used if the permeability is low enough to permit accurate determination of the water level. In the falling level test, the flow is from the hole to the surrounding soil and there is danger of clogging of the soil pores by sediment in the test water used. This danger does not exist in the rising level test, where water flows from the surrounding soil to the hole, but there is the danger of the soil at the bottom of the hole becoming loosened or quick if too great a gradient is imposed at the bottom of the hole. If the rising level is used, the test should be followed by sounding of the base of the hole with drill rods to determine whether heaving of the bottom has occurred. The rising level test is the preferred test. In those cases where the permeability is so high as to preclude accurate measurement of the rising or falling water level, the constant level test is used.

Holes in which seepage tests are to be performed should be drilled using only clear water as the drilling fluid. This precludes the formation of a mud cake on the walls of the hole or clogging of the pores of the soil by drilling mud. The tests are performed intermittently as the borehole is advanced. When the hole reaches the level at which a test is desired, the hole is cleaned and flushed using clear water pumped through a drill tool with shielded or upward-deflected jets. Flushing is continued until a clean surface of undisturbed material exists at the bottom of the hole. The permeability is then determined by one of the procedures given below. Specifications sometimes require a limited advancement of the borehole without casing upon completion of the first test at a given level, followed by cleaning, flushing, and repeat testing. The difficulty of obtaining satisfactory in situ permeability measurements makes this requirement a desirable feature since it permits verification of the test results.

Data which must be recorded for each test regardless of the type of test performed include:

1. Depth from the ground surface to groundwater surface both before and after the test,
2. Inside diameter of the casing,
3. Height of the casing above the ground surface,
4. Length of casing at the test section,
5. Diameter of the borehole below the casing,
6. Depth to the bottom of the boring from the top of the casing,
7. Depth to the standing water level from the top of the casing, and
8. A description of the material tested.

#### **Falling Water Level Method**

In this test, the casing is filled with water, which is then allowed to seep into the soil. The rate of drop of the water surface in the casing is observed by measuring the depth of the water surface below the top of the casing at 1, 2 and 5 minutes after the start of the test and at 5-minute intervals thereafter. These observations are made until the rate of drop becomes negligible or until sufficient readings have been obtained to satisfactorily determine the permeability. Other required observations are listed above.

#### **Rising Water Level Method**

This method, most commonly referred to as the "time lag method" (US Army Corps of Engineers, 1951), consists of bailing the water out of the casing and observing the rate of rise of the water level in the casing at intervals until the rise in the water level becomes negligible. The rate is observed by measuring the elapsed time and the depth of the water surface below the top of the casing. The intervals at which the readings are required will vary somewhat with the permeability of the soil. The readings should be frequent enough to establish the equalization diagram. In no case should the total elapsed time for the readings be less than 5 minutes. As noted above, a rising level test should always be followed by a sounding of the bottom of the hole to determine whether the test created a quick condition.

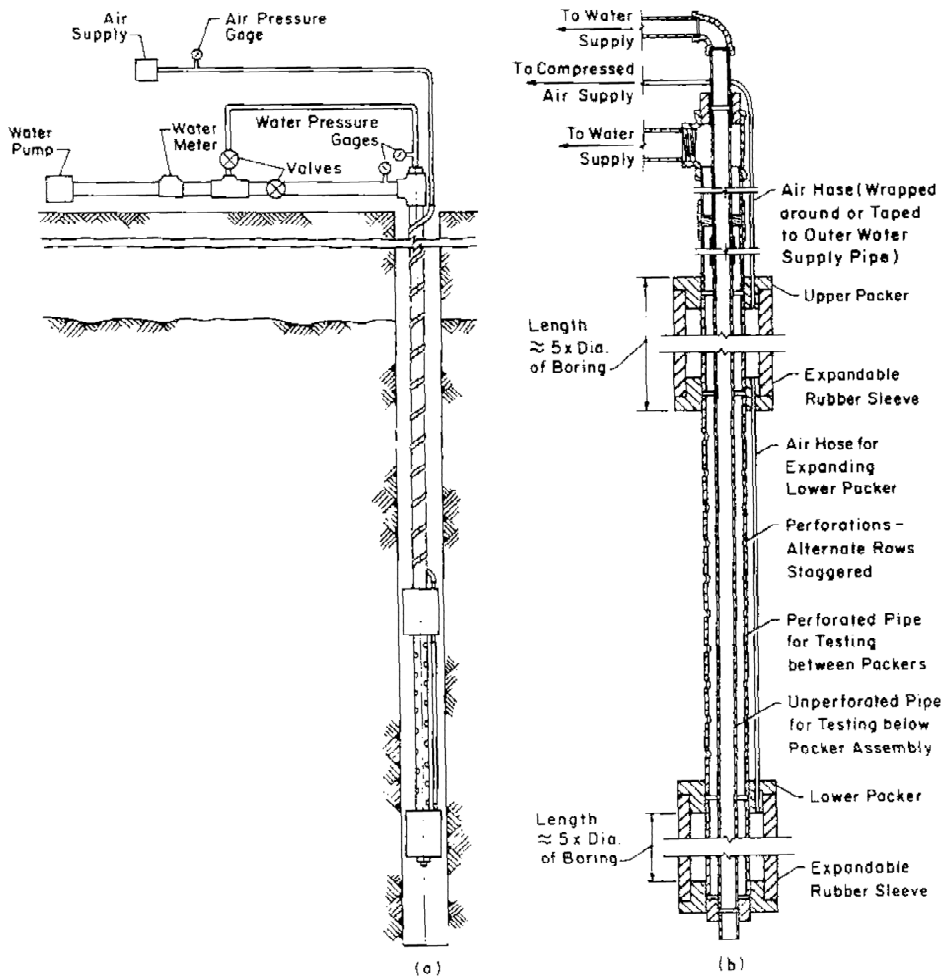
#### **Constant Water Level Method**

In this method water is added to the casing at a rate sufficient to maintain a constant water level at or near the top of the casing for a period of not less than 10 minutes. The water may be added by pouring from calibrated containers or by pumping through a water meter. In addition to the data listed in the above general discussion, the data recorded should consist of the amount of water added to the casing at 5 minutes after the start of the test, and at 5-minute intervals thereafter until the amount of added water becomes constant.

### 6.3.2 Pressure (“Packer”) Test

A test in which water is forced under pressure into rock through the walls of a borehole provides a means of determining the apparent permeability of the rock, and yields information regarding its soundness. The information thus obtained is used primarily in seepage studies. It is also frequently used as a qualitative measure of the grouting required for reducing the permeability of rock or strengthening it. Pressure tests should be performed only in holes that have been drilled with clear water.

The apparatus used for pressure tests in rock is illustrated schematically in Figure 6-2a. It comprises a water pump, a manually-adjusted automatic pressure relief valve, pressure gages, a water meter, and a packer assembly. The packer assembly, shown in Figure 6-2b, consists of a system of piping to which two expandable cylindrical rubber sleeves, called packers, are attached. The packers, which provide a means of sealing off a limited section of borehole for testing, should have a length at least five times the diameter of the hole. They may be of the pneumatically, hydraulically, or mechanically expandable type.



**Figure 6-2. Packer-Type Pressure-Test Apparatus for Determining the Permeability of Rock. (a) Schematic Diagram; (b) Detail of Packer Unit. (Lowe and Zaccheo, 1991)**

Pneumatic or hydraulic packers are preferred since they adapt to an oversized hole whereas mechanical packers may not. However, when pneumatic/hydraulic packers are used, the test apparatus must also include an air or water supply connected, through a pressure gage, to the packers by means of a high-pressure hose as shown in Figure 6-2a. The piping of the packer assembly is designed to permit testing of either the portion of the hole between the packers or the portion below the lower packer. Flow to the section below the lower packer is through the interior pipe; flow to the section between the packers is provided by perforations in the outer pipe, which have an outlet area two or more times the cross-sectional area of the pipe. The packers are normally set 0.6, 1.5 or 3 m apart and it is common to provide flexibility in testing by having assemblies with different packer spacing available, thereby permitting the testing of different lengths of the hole. The wider spacings are used for rock that is more uniform; the short spacing is used to test individual joints that may be the cause of high water loss in otherwise tight strata.

The test procedure used depends upon the condition of rock. In rock that is not subject to cave-in, the following method is in general use. After the borehole has been completed it is filled with clear water, surged, and washed out. The test apparatus is then inserted into the hole until the top packer is at the top of the rock. Both packers are then expanded and water under pressure is introduced into the hole, first between the packers and then below the lower packer. Observations of the elapsed time and the volume of water pumped at different pressures are recorded as detailed in the paragraph below. Upon completion of the test, the apparatus is lowered a distance equal to the space between the packers and the test is repeated. This procedure is continued until the entire length of the hole has been tested or until there is no measurable loss of water in the hole below the lower packer. If the rock in which the hole is being drilled is subject to cave-in, the pressure test is conducted after each advance of the hole for a length equal to the maximum permissible unsupported length of the hole or the distance between the packers, whichever is less. In this case, the test is limited, of course, to the zone between the packers.

The magnitudes of these test pressures are commonly 100, 200 and 300 kPa above the natural piezometric level. However, in no case should the excess pressure above the natural piezometric level be greater than 23 kPa per meter of soil and rock overburden above the upper packer. This limitation is imposed to insure against possible heaving and damage to the foundation. In general, each of the above pressures should be maintained for 10 minutes or until a uniform rate of flow is attained, whichever is longer. If a uniform rate of flow is not reached in a reasonable time, the engineer must use his/her discretion in terminating the test. The quantity of flow for each pressure should be recorded at 1, 2 and 5 minutes and for each 5-minute interval thereafter. Upon completion of the tests at 100, 200 and 300 kPa the pressure should be reduced to 200 and 100 kPa, respectively, and the rate of flow and elapsed time should once more be recorded in a similar manner.

Observation of the water take with increasing and decreasing pressure permits evaluation of the nature of the openings in the rock. For example, a linear variation of flow with pressure indicates an opening that neither increases nor decreases in size. If the curve of flow versus pressure is concave upward it indicates that the openings are enlarging; if convex, the openings are becoming plugged. Detailed discussion for interpretation of pressure tests is presented by Cambefort (1964). Additional data required for each test are as follows:

1. Depth of the hole at the time of each test,
2. Depth to the bottom of the top packer,
3. Depth to the top of the bottom packer,
4. Depth to the water level in the borehole at frequent intervals (this is important since a rise in water level in the borehole may indicate leakage around the top packer. Leakage around the bottom packer would be indicated by water rising in the inner pipe).

5. Elevation of the piezometric level,
6. Length of the test section,
7. Radius of the hole,
8. Length of the packer,
9. Height of the pressure gage above the ground surface,
10. Height of the water swivel above the ground surface, and
11. A description of the material tested.

The formulas used to compute the permeability from pressure tests data are (from *Earth Manual*, US Bureau of Reclamation, 1960):

$$k = \frac{Q}{2\pi LH} \ln\left(\frac{L}{r}\right) \quad \text{for } L \geq 10r \quad (6a)$$

$$k = \frac{Q}{2\pi LH} \sinh^{-1}\left(\frac{L}{2r}\right) \quad \text{for } 10r > L > r \quad (6b)$$

where, k is the apparent permeability, Q is the constant rate of flow into the hole, L is the length of the test section, H is the differential head on the test section, and r is the radius of the borehole.

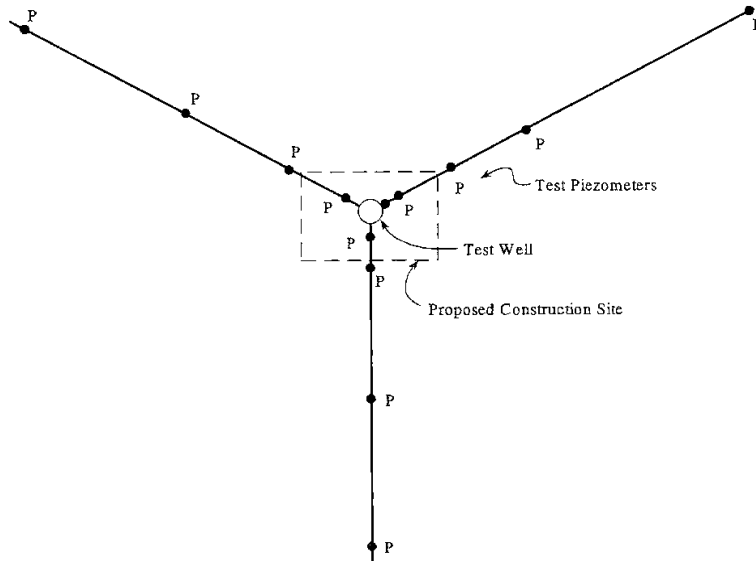
The formulas provide only approximate values of k since they are based on several simplifying assumptions and do not take into account the flow of water from the test section back to the borehole. However, they give values of the correct magnitude and are suitable for practical purposes.

### 6.3.3 Pumping Tests

Continuous pumping tests are used to determine the water yield of individual wells and the permeability of subsurface materials in situ. The data provided by such tests are used to determine the potential for leakage through the foundations of water-retaining structures and the requirements for construction dewatering systems for excavations.

The test consists of pumping water from a well or borehole and observing the effect on the water table by measuring the water levels in the hole being pumped and in an array of observation wells. The observation wells should be of the piezometer type. The depth of the test well will depend on the depth and thickness of the strata to be tested. The number, location, and depth of the observation wells or piezometers will depend on the estimated shape of the groundwater surface after drawdown. Figure 6-3 shows a typical layout of piezometers for a pumping test. As shown in Figure 6-3, the wells should be located on the radial lines passing through the test well. Along each of the radial lines there should be a minimum of four wells, the innermost of which should be within 7.5 m of the test well; The outermost should be located near the limits of the effect of drawdown, and the middle wells should be located to give the best definition of the drawdown curve based on its estimated shape.





**Figure 6-3. A General Configuration and Layout of Piezometers for a Pumping Test.**

The pump used for these tests should have a capacity of 1.5 to 2 times the maximum anticipated flow and should have a discharge line sufficiently long to obviate the possibility of the discharge water recharging the strata being tested. Auxiliary equipment required include an air line to measure the water level in the test well, a flow meter, and measuring devices to determine the depth to water in the observation well. The air line, complete with pressure gage, hand pump, and check valve, should be securely fastened to the pumping level but in no case closer than 0.6 m beyond the end of the suction line. The flow meter should be of the visual type, such as an orifice. The depth-measuring device for the observation well may be any of the types described in Section 6.2.

The test procedure for field pumping tests is as follows: Upon completion of the well or borehole, the hole is cleaned and flushed, the depth of the well is accurately measured, the pump is installed, and the well is developed. The well is then tested at 1/3, 2/3 and full capacity. Full capacity is defined as the maximum discharge attainable with the water levels in the test and observation wells stabilized. Each of the discharge rates is maintained for 4 hours after further drawdown in the test and observation well has ceased, or for a maximum of 48 hours, whichever occurs first. The discharge must be maintained constant during each of the three stages of the test and interruptions of pumping are not permitted. If pumping should accidentally be interrupted, the water level should be permitted to return to its full non-pumping level before pumping is resumed. Upon completion of the drawdown test, the pump is shut off and the rate of recovery is observed.

The basic test well data which must be recorded are:

1. Location, top elevation and depth of the well,
2. The size and length of all blank casing in the well,
3. Diameter, length, and location of all screen casing used; also the type and size of the screen opening and the material of which the screen is made,
4. Type of filter pack used, if any,
5. The water elevation in the well prior to testing, and
6. Location of the bottom of the air line.

Information required for each observation well are:

1. Location, top elevation, and depth of the well,
2. The size and elevation of the bottom of the casing (after installation of the well),
3. Location of all blank casing sections,
4. Manufacturer, type, and size of the pipes etc.
5. Depth and elevation of the well and
6. Water level in the well prior to testing.

Pump data required include the manufacturer's model designation, pump type, maximum capacity, and capacity at 1800 rpm. The drawdown test data recorded for each discharge rate consist of the discharge and drawdowns of the test well and each observation well at the time intervals shown in Table 6-1.

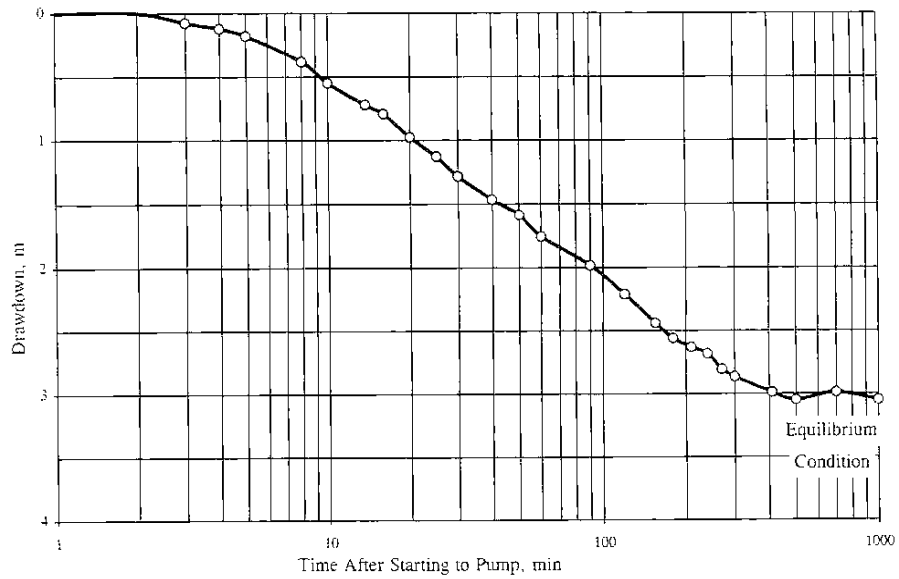
**TABLE 6-2.**

**TIME INTERVALS FOR READING DURING PUMPING TEST**

Elapsed Time	Time Interval for Readings
0-10 min	0.5 min
10-60 min	2.0 min
1-6 hour	15.0 min
6-9 hour	30.0 min
9-24 hour	1.0 hour
24-48 hour	3.0 hour
>48 hour	6.0 hour

The required recovery curve data consist of readings of the depth to water at the test location and observation wells at the same time intervals given in Table 6-2. Readings are continued until the water level returns to the prepumping level or until adequate data have been obtained. A typical time-drawdown curve is shown in Figure 6-4. Generally, the time-drawdown curve becomes straight after the first few minutes of pumping. If true equilibrium conditions are established, the drawdown curve will become horizontal.

Field drawdown tests may be conducted using 2 or more cased wells and measuring the drop in head with time. A submersible pump at a central well is used for the drawdown and the head loss at two radial distances may be measured manually or automated via pore pressure transducers. Sowers (1979) discusses the details briefly for two cases: (1) an unconfined aquifer over an impervious layer and (2) artesian aquifer. If the gradient of the drawdown is not too great ( $< 25^\circ$  slope), then the head loss in the drawdown well may be used itself ( $r_1 =$  well radius) and only two cased wells are necessary.



**Figure 6-4. Drawdown in an Observation Well Versus Pumping Time (Logarithmic Scale).**

For the case of measured drawdown pressures in an unconfined aquifer (shown in Figure 6-5), the permeability ( $k$  in cm/s) of the transmitting medium is given by:

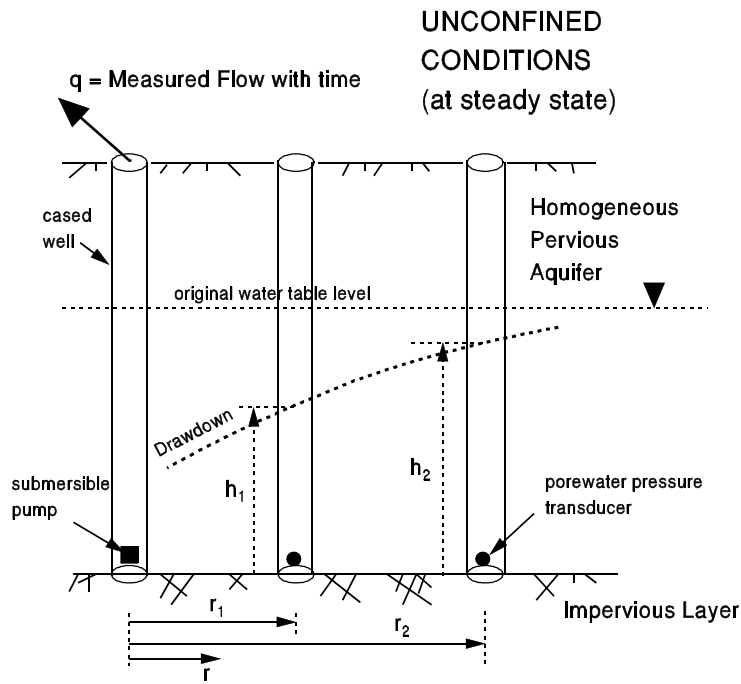
$$\text{Unconfined: } k = \frac{q \ln(r_2/r_1)}{B [(h_2)^2 - (h_1)^2]} \quad (6-7)$$

where  $q$  = measured flow with time ( $\text{cm}^3/\text{s}$ ),  $r$  = radial distance (cm), and  $h$  = height of water above the reference elevation (cm).

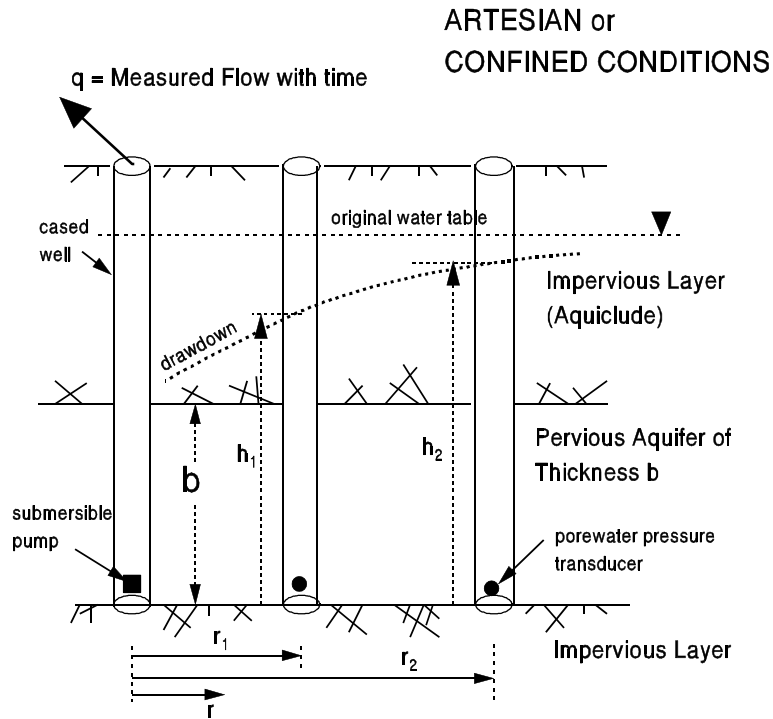
For a confined aquifer where an impervious clay aquiclude caps the permeable aquifer, the permeability is determined from:

$$\text{Confined: } k = \frac{q \ln(r_2/r_1)}{2Bb (h_2 - h_1)} \quad (6-8)$$

where  $b$  = thickness of the aquifer (Figure 6-6).



**Figure 6-5. Definitions of Terms in Pumping Test Within an Unconfined Aquifer.**



**Figure 6-6. Definitions of Terms in Pumping Test Within a Confined Aquifer System.**

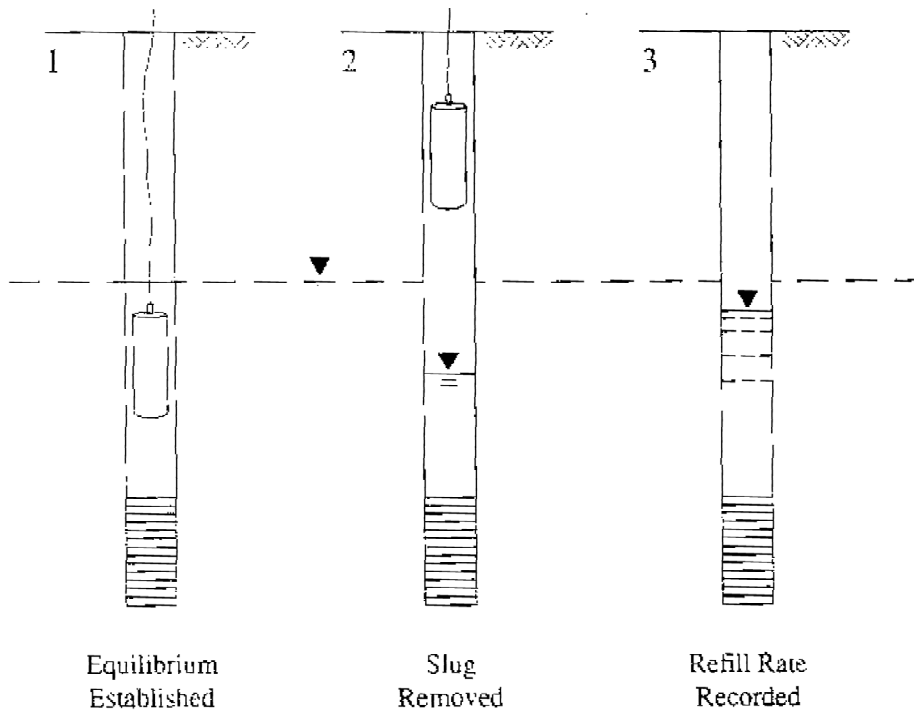
### 6.3.4 Slug Tests

Using mechanical slug tests (ASTM 4044) in which a solid object is used to displace water and induce a sudden change of head in a well to determine permeability has become common in environmental investigations. Figure 6-7 presents the slug test procedure. It is conducted in a borehole in which a screened (slotted) pipe is installed. The solid object, called a “slug”, often consists of a weighted plastic cylinder. The slug is submerged below the water table until equilibrium has been established; then the slug is removed suddenly, causing an “instantaneous” lowering of the water level within the observation well. Finally, as the well gradually fills up with water, the refill rate is recorded. This is termed the “slug out” procedure.

The permeability,  $k$ , is then determined from the refill rate. In general, the more rapid the refill rate, the higher the  $k$  value of the screened sediments.

It is also possible to run a “slug in” test. This is similar to the slug out test, except the plastic slug is suddenly dropped into the water, causing an “instantaneous” water level rise. The decay of this water level back to static is then used to compute the permeability. A slug in and slug out test can be performed on the same well.

Alternatively, instead of using a plastic slug, it is possible to lower the water level in the well using compressed air (or raising it using a vacuum) and then suddenly restore atmospheric pressure by opening a quick-release valve.



**Figure 6-7. General Procedure for Slug Test in as Screened Borehole.**

With either method, a pressure transducer and data logger are used to record time and water levels. In instances where water-level recovery is slow enough, hand-measured water levels (see Section 6.2) are adequate. Once, the data have been collected, drawdown is graphed versus time, and various equations and/or curve-matching techniques are used to compute permeability.

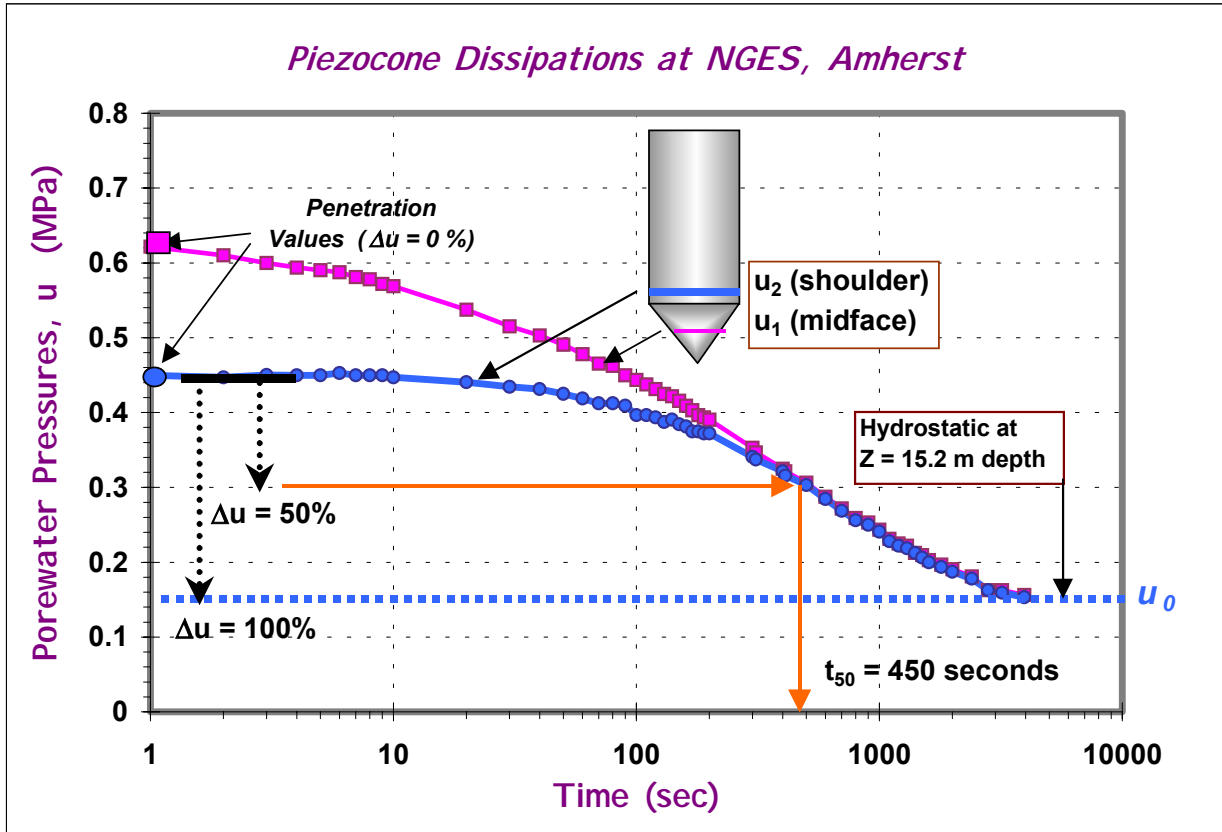
Much of the popularity of these tests results from the ease and low cost of conducting them. Unfortunately, however, slug tests are not very reliable. They can give wrong answers, lead to misinterpretation of aquifer characteristics, and ultimately, improper design of dewatering or remediation systems. Several shortcomings of the slug tests may be summarized as follows (Driscoll, 1986):

1. Variable accuracy: Slug tests may be accurate or may underestimate permeability by one or two orders or magnitude. The test data will provide no clue as to the accuracy of the computed value unless a pumping test is done in conjunction with slug tests.
2. Small zone of investigation: Because slug tests are of short duration, the data they provide reflect aquifer properties of just those sediments very near the well intake. Thus, a single slug test does not effectively integrate aquifer properties over a broad area.
3. Slug tests cannot predict the storage capacity of an aquifer.
4. It is difficult to analyze data from wells screened across the water table.
5. Rapid slug removal often causes pressure transients that can obscure some of the early test data.
6. If the true static water level is not determined with great precision, large errors can result in the computed permeability values.

Therefore, it is crucial that a qualified hydrogeologist assesses the results of the slug tests and ensures that they are properly applied and that data from them are not misused. Although the absolute magnitude of the permeability value obtained from slug tests may not be accurate, a comparison of values obtained from tests in holes judiciously located throughout a site being investigated can be used to establish the relative permeability of various portions of the site.

### **6.3.5 Piezocone Dissipation Tests**

In a CPT test performed in saturated clays and silts, large excess porewater pressures ( $\Delta u$ ) are generated during penetration of the piezocone. Soft to firm intact clays will exhibit measured penetration porewater pressures which are 3 to 6 times greater than the hydrostatic water pressure, while values of 10 to 20 times greater than the hydrostatic water pressure will typically be measured in stiff to hard intact clays. In fissured materials, zero or negative porewater pressures will be recorded. Regardless, once penetration is stopped, these excess pressures will decay with time and eventually reach equilibrium conditions which correspond to hydrostatic values. In essence, this is analogous to a push-in type piezometer. In addition to piezometers and piezocones, excess pressures occur during the driving of pile foundations, installation of displacement devices such as vibroflots for stone columns and mandrels for vertical wick-drains, as well as insertion of other in-situ tests including dilatometer, full-displacement pressuremeter, and field vane. How quickly the porewater pressures decay depends on the permeability of the surrounding medium ( $k$ ), as well as the horizontal coefficient of consolidation ( $c_h$ ), as per equation 6-4. In clean sands and gravels that are pervious, essentially drained response is observed at the time of penetration and the measured porewater pressures are hydrostatic. In most other cases, an initial undrained response occurs that is followed by drainage. For example, in silty sands, generated excess pressures can dissipate in 1 to 2 minutes, while in contrast, fat plastic clays may require 2 to 3 days for complete equalization.



**Figure 6-8. Porewater Pressure Dissipation Response in Soft Varved Clay at Amherst NGES.**  
 (Procedure for  $t_{50}$  determination using  $U_2$  readings shown)

Representative dissipation curves from two types of piezocone elements (midface and shoulder) are presented in Figure 6-8. These data were recorded at a depth of 15.2 meters in a deposit of soft varved silty clay at the National Geotechnical Experimentation Site (NGES) in Amherst, MA. Full equalization to hydrostatic conditions is reached in about 1 hour (3600 s). In routine testing, data are recorded to just 50 percent consolidation in order to maintain productivity. In this case, the initial penetration pressures correspond to 0 percent decay and a calculated hydrostatic value ( $u_0$ ) based on groundwater levels represents the 100 percent completion. Figure 6-8 illustrates the procedure to obtain the time to 50 percent completion ( $t_{50}$ ).

The aforementioned approach applies to soils that exhibit monotonic decay of porewater pressures with logarithm of time. For cases involving heavily overconsolidated and fissured geomaterials, a dilatory response can occur whereby the porewater pressures initially rise with time, reach a peak value, and then subsequently decrease with time.

For type 2 piezocones with shoulder filter elements, the  $t_{50}$  reading from monotonic responses can be used to evaluate the permeability according to the chart provided in Figure 6-9. The average relationship may be approximately expressed by:

$$k \text{ (cm / s)} \approx \left( \frac{1}{251 \cdot t_{50}} \right)^{1.25} \tag{6-9}$$

where  $t_{50}$  is given in seconds. The interpretation of the coefficient of consolidation from dissipation test data is discussed in Chapter 9 and includes a procedure for both monotonic and dilatory porewater pressure behavior.

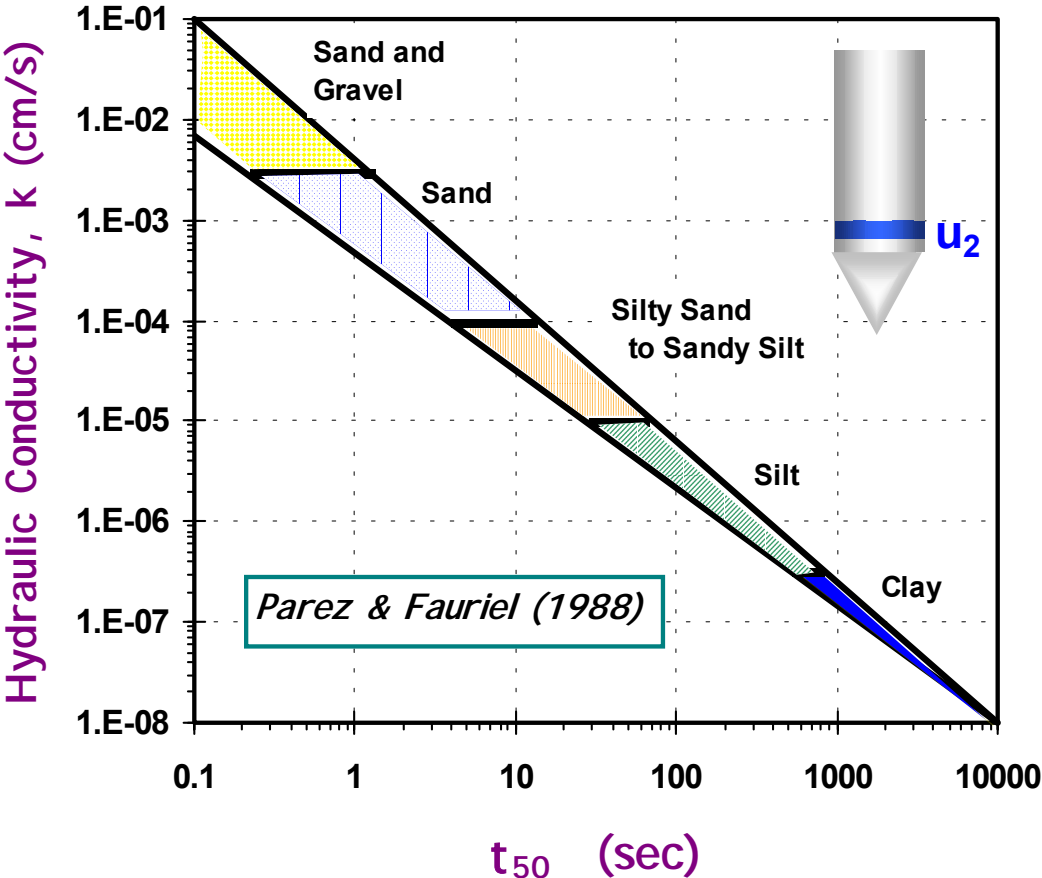


Figure 6-9. Coefficient of Permeability ( $k$  = Hydraulic Conductivity) from Measured Time to 50% Consolidation ( $t_{50}$ ) for Monotonic Type 2 Piezocone Dissipation Tests (from Parez & Fauriel, 1988).



## CHAPTER 7.0

### LABORATORY TESTING FOR SOILS

#### 7.1 GENERAL

Laboratory testing of soils is a fundamental element of geotechnical engineering. The complexity of testing required for a particular project may range from a simple moisture content determination to specialized strength and stiffness testing. Since testing can be expensive and time consuming, the geotechnical engineer should recognize the project's issues ahead of time so as to optimize the testing program, particularly strength and consolidation testing.

Before describing the various soil test methods, soil behavioral under load will be examined and common soil mechanics terms introduced. The following discussion includes only basic concepts of soil behavior. However, the engineer must grasp these concepts in order to select the appropriate tests to model the in-situ conditions. The terms and symbols shown will be used in all the remaining modules of the course. Basic soil mechanics textbooks should be consulted for further explanation of these and other terms.

##### 7.1.1 Weight-Volume Concepts

A sample of soil is usually composed of soil grains, water and air. The soil grains are irregularly shaped solids which are in contact with other adjacent soil grains. The weight and volume of a soil sample depends on the specific gravity of the soil grains (solids), the size of the space between soil grains (voids and pores) and the amount of void space filled with water. Common terms associated with weight-volume relationships are shown in Table 7-1. Of particular note is the void ratio ( $e$ ) which is a general indicator of the relative strength and compressibility of a soil sample, i.e., low void ratios generally indicate strong soils of low compressibility, while high void ratios are often indicative of weak & highly compressible soils. Selected weight-volume (unit weight) relations are presented in Table 7-2.

TABLE 7-1.

#### TERMS IN WEIGHT-VOLUME RELATIONS (After Cheney and Chassie, 1993)

Property	Symbol	Units <sup>1</sup>	How obtained (AASHTO/ASTM)	Direct Applications
Moisture Content	w	D	By measurement (T 265/ D 4959)	Classification and in weight-volume relations
Specific Gravity	$G_s$	D	By measurement (T 100/D 854)	Volume computations
Unit weight	(	$FL^{-3}$	By measurement or from weight-volume relations	Classification and for pressure computations
Porosity	n	D	From weight-volume relations	Defines relative volume of solids to total volume of soil
Void Ratio	e	D	From weight-volume relations	Defines relative volume of voids to volume of solids

<sup>1</sup> F = Force or weight; L = Length; D = Dimensionless. Although by definition, moisture content is a dimensionless fraction (ratio of weight of water to weight of solids), it is commonly reported in percent by multiplying the fraction by 100.

TABLE 7-2.

UNIT WEIGHT-VOLUME RELATIONSHIPS

<i>Case</i>	<i>Relationship</i>	<i>Applicable Geomaterials</i>
Soil Identities:	1. $G_s w = S e$ 2. Total Unit Weight: $\gamma_T = \frac{(1+w)}{(1+e)} G_s \gamma_w$	All types of soils & rocks
Limiting Unit Weight	Solid phase only: $w = e = 0$ : $\gamma_{rock} = G_s \gamma_w$	Maximum expected value for solid silica is 27 kN/m <sup>3</sup>
Dry Unit Weight	For $w = 0$ (all air in void space): $\gamma_d = G_s \gamma_w / (1+e)$	Use for clean sands and dry soils above groundwater table
Moist Unit Weight (Total Unit Weight)	Variable amounts of air & water: $\gamma_t = G_s \gamma_w (1+w)/(1+e)$ with $e = G_s w/S$	Partially-saturated soils above water table; depends on degree of saturation (S, as decimal).
Saturated Unit Weight	Set $S = 1$ (all voids with water): $\gamma_{sat} = \gamma_w (G_s + e)/(1+e)$	All soils below water table; Saturated clays & silts above water table with full capillarity.
Hierarchy:	$\gamma_d \# \gamma_t \# \gamma_{sat} < \gamma_{rock}$	Check on relative values

Note:  $\gamma_w = 9.8 \text{ kN/m}^3$  (62.4 pcf) for fresh water

7.1.2 Load-Deformation Process in Soils

When a load is applied to a soil sample, the deformation which occurs will depend on the grain-to-grain contact (intergranular) forces and the amount of water in the voids. If no porewater exists, the sample deformation will be due to sliding between soil grains and deformation of the individual soil grains. The rearrangement of soil grains due to sliding accounts for most of the deformation. Adequate deformation is required to increase the grain contact areas to take the applied load. As the amount of pore water in the void increases, the pressure it exerts on soil grains will increase and reduce the intergranular contact forces. In fact, tiny clay particles may be forced completely apart by water in the pore space.

Deformation of a saturated soil is more complicated than that of dry soil as water molecules, which fill the voids, must be squeezed out of the sample before readjustment of soil grains can occur. The more permeable a soil is, the faster the deformation under load will occur. However, when the load on a saturated soil is quickly increased, the increase is carried entirely by the pore water until drainage begins. Then more and more load is gradually transferred to the soil grains until the excess pore pressure has dissipated and the soil grains readjust to a denser configuration. This process is called *consolidation* and results in a higher unit weight and a decreased void ratio.

### 7.1.3 Principle of Effective Stress

The consolidation process demonstrates the very important principle of effective stress, which will be used in all the remaining modules of this course. Under an applied load, the total stress in a saturated soil sample is composed of the intergranular stress and porewater pressure (neutral stress). As the porewater has zero shear strength and is considered incompressible, only the intergranular stress is effective in resisting shear or limiting compression of the soil sample. Therefore, the intergranular contact stress is called the *effective stress*. Simply stated, this fundamental principle states that *the effective stress ( $F'$ ) on any plane within a soil mass is the net difference between the total stress ( $F$ ) and porewater pressure ( $u$ ).*

When pore water drains from soil during consolidation, the area of contact between soil grains increases, which increases the level of effective stress and therefore the soil's shear strength. In practice, staged construction of embankments is used to permit increase of effective stress in the foundation soil before subsequent fill load is added. In such operations the effective stress increase is frequently monitored with piezometers to ensure the next stage of embankment can be safely placed.

Soil deposits below the water table will be considered saturated and the ambient pore pressure at any depth may be computed by multiplying the unit weight of water ( $\gamma_w$ ) by the height of water above that depth. For partially saturated soil, the effective stress will be influenced by the soil structure and degree of saturation (Bishop, *et. al.*, 1960). In many cases involving silts & clays, the continuous void spaces that exist in the soil behave as capillary tubes of variable cross-section. Due to capillarity, water may rise above the static groundwater table (*phreatic surface*) as a negative porewater pressure and the soils may be nearly or fully saturated.

### 7.1.4 Overburden Stress

The purpose of laboratory testing is to simulate in-situ soil loading under controlled boundary conditions. Soils existing at a depth below the ground surface are affected by the weight of the soil above that depth. The influence of this weight, known generally as the *overburden stress*, causes a state of stress to exist which is unique at that depth for that soil. When a soil sample is removed from the ground, that state of stress is relieved as all confinement of the sample has been removed. In testing, it is important to reestablish the in-situ stress conditions and to study changes in soil properties when additional stresses representing the expected design loading are applied. In this regard, the effective stress (grain-to-grain contact) is the controlling factor in shear, state of stress, consolidation, stiffness, and flow. Therefore, the designer should try to re-establish the effective stress condition during most testing.

The test confining stresses are estimated from the total, hydrostatic, and effective overburden stresses. The engineer's first task is determining these stress and pressure variations with depth. This involves determining the total unit weights (density) for each soil layer in the subsurface profile, and determining the depth of the water table. Unit weight may be accurately determined from density tests on undisturbed samples or estimated from in-situ test measurements. The water table is routinely recorded on the boring logs, or can be measured in open standpipes, piezometers, and dissipation tests during CPTs and DMTs.

The total vertical (overburden) stress ( $F_{vo}$ ) at any depth ( $z$ ) may be found as the accumulation of total unit weights ( $\gamma_t$ ) of the soil strata above that depth:

$$F_{vo} = \int \gamma_t dz = \gamma_t z \quad (7-1)$$

For soils above the phreatic surface, the applicable value of total unit weight may be dry, moist, or saturated depending upon the soil type and degree of capillarity (see Table 7-2). For soil elements situated below the groundwater table, the saturated unit weight is normally adopted.

The hydrostatic pressure depends upon the degree of saturation and level of the phreatic surface and is determined as follow:

$$\text{Soil elements above water table: } u_o = 0 \quad (\text{Completely dry}) \quad (7-2a)$$

$$u_o = \gamma_w(z - z_w) \quad (\text{Full capillarity}) \quad (7-2b)$$

$$\text{Soil elements below water table: } u_o = \gamma_w(z - z_w) \quad (7-2c)$$

where  $z$  = depth of soil element,  $z_w$  = depth to groundwater table. Another case involves partial saturation with intermediate values between (7-2a and 7-2b) which literally vary daily with the weather and can be obtained via tensiometer measurements in the field. Usual practical calculations adopt (7-2a) for many soils, yet the negative capillary values from (7-2b) often apply to saturated clay & silt deposits.

The effective vertical stress is obtained as the difference between (7-1) and (7-2):

$$F'_{vo} = F_{vo} - u_o \quad (7-3)$$

A plot of effective overburden profile with depth is called a  $F'_v$  diagram and is extensively used in all aspects of foundation testing and analysis (see Holtz & Kovacs, 1981; Lambe & Whitman, 1979).

### 7.1.5 Selection and Assignment of Tests

Certain considerations regarding laboratory testing, such as when, how much, and what type, can only be decided by an experienced geotechnical engineer. The following minimal criteria should be considered while determining the scope of the laboratory testing program:

- C Project type (bridge, embankment, rehabilitation, buildings, etc.)
- C Size of the project
- C Loads to be imposed on the foundation soils
- C Types of loads (i.e., static, dynamic, etc.)
- C Critical tolerances for the project (e.g., settlement limitations)
- C Vertical and horizontal variations in the soil profile as determined from boring logs and visual identification of soil types in the laboratory
- C Known or suspected peculiarities of soils at the project location (i.e., swelling soils, collapsible soils, organics, etc.)
- C Presence of visually observed intrusions, slickensides, fissures, concretions, etc.

The selection of tests should be considered preliminary until the geotechnical engineer is satisfied that the test results are sufficient to develop reliable soil profiles and provide the soil parameters needed for design.

Following this subsection are brief discussions of frequently used soil properties and tests. These discussions assume that the reader will have access to the latest volumes of AASHTO and ASTM standards containing details of test procedures and will study them in connection with this presentation. Table 7-3 presents a summary list of AASHTO and ASTM tests frequently used for laboratory testing of soils.

**TABLE 7-3.**

**AASHTO AND ASTM STANDARDS FOR FREQUENTLY-USED  
LABORATORY TESTING OF SOILS**

<b>Test Category</b>	<b>Name of Test</b>	<b>Test Designation</b>	
		<b>AASHTO</b>	<b>ASTM</b>
Visual Identification	Practice for Description and Identification of Soils (Visual-Manual Procedure)	-	D 2488
	Practice for Description of Frozen Soils (Visual-Manual Procedure)	-	D 4083
Index Properties	Test Method for Determination of Water (Moisture) Content of Soil by Direct Heating Method	T 265	D 4959
	Test Method for Specific Gravity of Soils	T 100	D 854
	Method for Particle-Size Analysis of Soils	T 88	D 422
	Test Method for Amount of Material in Soils Finer than the No. 200 (75-: m) Sieve		D 1140
	Test Method for Liquid Limit, Plastic Limit, and Plasticity Index of Soils	T 89 T 90	D 4318
	Test Method for Laboratory Compaction Characteristics of Soil Using Standard Effort (600 kN-m/m <sup>3</sup> )	T 99	D 698
	Test Method for Laboratory Compaction Characteristics of Soil Using Modified Effort (2,700 kN-m/m <sup>3</sup> )	T 180	D 1557
Corrosivity	Test Method for pH of Peat Materials	-	D 2976
	Test Method for pH of Soils	-	D 4972
	Test Method for pH of Soil for Use in Corrosion Testing	T 289	G 51
	Test Method for Sulfate Content	T 290	D 4230
	Test Method For Resistivity	T 288	D 1125 G 57
	Test Method for Chloride Content	T 291	D 512
	Test Methods for Moisture, Ash, and Organic Matter of Peat and Other Organic Soils	T 194	D 2974
	Test Method for Classification of Soils for Engineering Purposes	M 145	D 2487 D 3282

**TABLE 7-3 (Continued)**

**AASHTO AND ASTM STANDARDS FOR FREQUENTLY USED  
LABORATORY TESTING OF SOILS**

<b>Test Category</b>	<b>Name of Test</b>	<b>Test Designation</b>	
		<b>AASHTO</b>	<b>ASTM</b>
Strength Properties	Unconfined Compressive Strength of Cohesive Soil	T 208	D 2166
	Unconsolidated, Undrained Compressive Strength of Clay and Silt Soils in Triaxial Compression	T 296	D 2850
	Consolidated-Undrained Triaxial Compression Test on Cohesive Soils	T 297	D 4767
	Direct Shear Test of Soils For Consolidated Drained Conditions	T 236	D 3080
	Modulus and Damping of Soils by the Resonant-Column Method (Small-Strain Properties)	-	D 4015
	Test Method for Laboratory Miniature Vane Shear Test for Saturated Fine-Grained Clayey Soil	-	D 4648
	Test Method for Bearing Ratio of Soils in Place	-	D 4429
	Test Method for CBR (California Bearing Ratio) of Laboratory-Compacted Soils	-	D 1883
	Test method For Resilient Modulus of Soils	T 294	-
Method for Resistance R-Value and Expansion Pressure of Compacted Soils	T 190	D 2844	
Permeability	Test Method for Permeability of Granular Soils (Constant Head)	T 215	D 2434
	Test Method for Measurement of Hydraulic Conductivity of Saturated Porous Materials Using a Flexible Wall Permeameter	-	D 5084
Compression Properties	Method for One-Dimensional Consolidation Properties of Soils (Oedometer Test)	T 216	D 2435
	Test Methods for One-Dimensional Swell or Settlement Potential of Cohesive Soils	T 258	D 4546
	Test Method for Measurement of Collapse Potential of Soils	-	D 5333

### 7.1.6 Visual Identification of Soils

Guidelines for visual identification of soils can be used in field as well as laboratory investigations.

<b>Visual Identification of Soils</b>	
AASHTO ASTM	- D 2488, D 4083
Purpose	<ol style="list-style-type: none"> <li>1. Verify the field description of soil color and soil type.</li> <li>2. Select representative specimens for various tests.</li> <li>3. Select specimens for special tests (i.e., slickensided soils for triaxial testing) to determine the effects of the soil macro structure on the overall properties.</li> <li>4. Locate and identify changes, intrusions, and disturbances within a sample.</li> <li>5. Verify or revise the soil description to be included in the boring logs or in soil profile presentations.</li> </ol>
Procedure	<p>The visual-manual examination should be done expeditiously to ascertain the percent fines, relative percentages of gravel, sand, silt, &amp; clay, as well as constituents &amp; composition.</p>
Commentary	<p>Prior to assigning laboratory tests, all soil samples submitted to a laboratory should be subjected to visual examination and identification. It is advisable for the geotechnical engineer to be present during the opening of samples for visual inspection. He should remain in contact with the laboratory, as he can offer valuable assistance in assessing soil properties.</p> <p><b>Disturbed Samples</b> As discussed earlier, disturbed samples are normally bulk samples of various sizes. Visual examinations of these samples are limited to the color, contents (i.e., gravel, concretions, sand, etc.) and consistency, as determined by handling a small, representative piece of the sample. The color of the soil should be determined by examining the samples in a jar or sealed can, where the moisture content is preserved near or at its natural condition. If more than one sample is obtained from the same deposit, the uniformity of the sample or lack of it is determined at this stage. This determination is used to decide on the proper mixing and quartering of disturbed samples to obtain representative specimens.</p> <p><b>Undisturbed Samples</b> Undisturbed samples should be opened for examination one sample at a time. Prior to opening, the sample number, depth and other identifying marks placed on the sample tube or wrapping should be checked against field logs. Samples should be laid on their side on a clean table top. If samples are soft, they should be supported in a sample cradle of appropriate size; they should not be examined on a flat table top.</p> <p>Samples should be examined in a humid room where possible, or in rooms where the temperature is neither excessively warm nor cold. Once the samples are unwrapped, the technician, engineer or geologist examining the sample identifies its color, soil type, variations and discontinuities identifiable from surface features such as silt and sand seams, trace of organics, fissures, shells, mica, other minerals, and important features.</p> <p>The apparent relative strength, as determined by a hand-held penetrometer, is often noted during this process. Samples should be handled very gently to avoid disturbing the material. The examination should be done quickly before changes in the natural moisture content occur.</p>

### 7.1.7 Index Properties

Index properties are used to characterize soils and determine their basic properties such as moisture content, specific gravity, particle size distribution, consistency and moisture-density relationships.

<b>Moisture Content</b>	
AASHTO ASTM	T 265 D 4959
Purpose	To determine the amount of water present in a quantity of soil in terms of its dry weight and to provide general correlations with strength, settlement, workability and other properties.
Procedure	Oven-dry the soil at a temperature of $110 \pm 5^\circ\text{C}$ to a constant weight (evaporate free water); this is usually achieved in 12 to 18 hours.
Commentary	<p>Determination of the moisture content of soils is the most commonly used laboratory procedure. The moisture content of soils, when combined with data obtained from other tests, produces significant information about the characteristics of the soil. For example, when the in situ moisture content of a sample retrieved from below the phreatic surface approaches its liquid limit, it is an indication that the soil in its natural state is susceptible to larger consolidation settlement.</p> <p>Serious errors may be introduced if the soil contains other components, such as petroleum products or easily ignitable solids. When the soils contain fibrous organic matter, absorbed water may be present in the organic fibers as well as in the soil voids. The test procedure does not differentiate between pore water and absorbed water in organic fibers (although the procedure does suggest evaluating organic soils at a lower temperature of <math>60^\circ\text{C}</math> to reduce decomposition of highly organic soils). Thus the moisture content measured will be the total moisture lost rather than free moisture lost (from void spaces). As discussed later, this may introduce serious errors in the determination of Atterberg limits.</p>

<b>Specific Gravity</b>	
AASHTO ASTM	T 100 D 854
Purpose	To determine the specific gravity of the soil grains.
Procedure	The specific gravity is determined as the ratio of the weight of a given volume of soil solids at a given temperature to the weight of an equal volume of distilled water at that temperature, both weights being taken in air.
Commentary	<p>Some qualifying words like <i>true</i>, <i>absolute</i>, <i>apparent</i>, <i>bulk</i> or <i>mass</i>, etc. are sometimes added to "specific gravity". These qualifying words modify the sense of specific gravity as to whether it refers to soil grains or to soil mass. The soil grains have permeable and impermeable voids inside them. If all the internal voids of soil grains are excluded for determining the true volume of grains, the specific gravity obtained is called <i>absolute</i> or <i>true</i> specific gravity.</p> <p>Complete de-airing of the soil-water mix during the test is imperative while determining the <i>true</i> or <i>absolute</i> value of specific gravity.</p> <p>A value of specific gravity is necessary to compute the void ratio of a soil, it is used in the hydrometer analysis, and it is useful to predict the unit weight of a soil (see Table 7-2). Occasionally, the specific gravity may be useful in soil mineral classifications; e.g., iron minerals have a larger value of specific gravity than silica.</p>



## Unit Weight

The measurement of unit weight for undisturbed soil samples in the laboratory is simply determined by weighing a portion of a soil sample and dividing by its volume. This is convenient with thin-walled tube (Shelby) samples, as well as piston, Sherbrooke, Laval, and NGI samplers, as well. The water content should be obtained at the same time to allow conversion from total to dry unit weights, as needed.

Where undisturbed samples are not available, the unit weight is evaluated from weight-volume relations between the water content and/or void ratio, as well as the assumed or measured degree of saturation (see Table 7-2). Additional methods using in-situ test data are discussed in Chapter 9.



**Figure 7-1. Laboratory Sieves for Mechanical Analysis for Grain Size Distributions.**

Shown (right to left) are Sieve Nos. 3/8-in. (9.5-mm), No. 10 (2.0-mm), No. 40 (250-µm) and No. 200 (750-µm) and example soil particle sizes including (right to left): medium gravel, fine gravel, medium-coarse sand, silt, and dry clay (kaolin).

<b>Sieve Analysis</b>	
AASHTO ASTM	T 88 D 422, D 1140
Purpose	To determine the percentage of various grain sizes. The grain size distribution is used to determine the textural classification of soils (i.e., gravel, sand, silty clay, etc.) which in turn is useful in evaluating the engineering characteristics such as permeability, strength, swelling potential, and susceptibility to frost action.
Procedure	<p>Wash a prepared representative sample through a series of sieves (screens). Figure 7-1 shows a selection of sieves and soil particle sizes. The amount retained on each sieve is collected, dried, and weighed to determine the percentage of material passing that sieve size. Figure 7-2 shows several grain size distributions obtained from sieving and hydrometer methods including natural clays, silts, and various sands.</p> <div style="text-align: center;"> <p>The graph plots Percent Passing (by weight) on the y-axis (0 to 100) against Grain Size (mm) on the x-axis (0.0001 to 10). Three curves are shown: Silica Sand (blue diamonds), Piedmont Silt (red squares), and Plastic Kaolin (green circles). Vertical dashed lines indicate Clay Size (&lt; 0.075 mm), Silt Size (0.075 to 0.25 mm), Sand Size (0.25 to 75 mm), and Gravel (&gt; 75 mm). The Silica Sand curve shows 0% passing for sizes up to 0.075 mm, then rises to 100% at 75 mm. The Piedmont Silt curve shows 0% passing up to 0.075 mm, then rises to 100% at 75 mm. The Plastic Kaolin curve shows 0% passing up to 0.075 mm, then rises to 100% at 0.25 mm.</p> </div> <p style="text-align: center;"><b>Figure 7-2: Representative Grain Size Curves for Several Soil Types.</b></p>
Commentary	<p>Obtaining a representative specimen is an important aspect of this test. When samples are dried for testing or “washing,” it may be necessary to break up the soil clods. Care should be made to avoid crushing of soft carbonate or sand particles. If the soil contains a substantial amount of fibrous organic materials, these may tend to plug the sieve openings during washing. The material settling over the sieve during washing should be constantly stirred to avoid plugging.</p> <p>Openings of fine (&lt; No. 200) mesh or fabric are easily distorted as a result of normal handling and use. They should be replaced often. A simple way to determine whether sieves should be replaced is the periodic examination of the stretch of the sieve fabric on its frame. The fabric should remain taut; if it sags, it has been distorted and should be replaced. A common cause of serious errors is the use of “dirty” sieves. Some soil particles, because of their shape, size or adhesion characteristics, have a tendency to be lodged in the sieve openings.</p>

<b>Hydrometer Analysis</b>	
AASHTO ASTM	T 88 D 1140
Purpose	To determine distribution (percentage) of particle sizes smaller than No. 200 sieve (< 0.075 mm) and identify the silt, clay, and colloids percentages in the soil.
Procedure	Soil passing the No. 200 sieve is mixed with a dispersant and distilled water and placed in a special graduated cylinder in a state of liquid suspension. The specific gravity of the mixture is periodically measured using a calibrated hydrometer to determine the rate of settlement of soil particles. The relative size and percentage of fine particles are determined based on Stoke's law for settlement of idealized spherical particles.
Commentary	<p>The principal value of the hydrometer analysis is in obtaining the clay fraction (percent finer than 0.002 mm). This is because the soil behavior for a cohesive soil depends principally on the type and percent of clay minerals, the geologic history of the deposit, and its water content rather than on the distribution of particle sizes.</p> <p>Replicable results can be obtained when soils are largely composed of common mineral ingredients. Results can be distorted and erroneous when the composition of the soil is not taken into account to make corrections for the specific gravity of the specimen. Particle size of highly organic soils cannot be determined by the use of this method.</p>

<b>Atterberg Limits</b>	
AASHTO ASTM	T 89, T 90 D 4318
Purpose	To describe the consistency and plasticity of fine-grained soils with varying degrees of moisture.
Procedure	<p>For the portion of the soil passing the No. 40 sieve, the moisture content is varied to identify three stages of soil behavior in terms of consistency. These stages are known as the liquid limit (LL), plastic limit (PL) and shrinkage limit (SL) of soils.</p> <ul style="list-style-type: none"> <li>' The <i>liquid limit</i> (LL) is defined as the water content at which 25 blows of the liquid limit machine (Figure 7-3a) closes a standard groove cut in the soil pat for a distance of 12.7 cm. An alternate procedure in Europe and Canada uses a fall cone device to obtain better repeatability (Figure 7-3b).</li> <li>' The <i>plastic limit</i> (PL) is as the water content at which a thread of soil, when rolled down to a diameter of 3 mm, will crumble.</li> <li>' The <i>shrinkage limit</i> (SL) is defined as that water content below which no further soil volume change occurs with further drying.</li> </ul>
Commentary	<p>The Atterberg limits provide general indices of moisture content relative to the consistency and behavior of soils. The LL defines a liquid/semi-solid change, while the PL is a solids boundary. The difference is termed the <i>plasticity index</i> (<math>PI = LL - PL</math>). The <i>liquidity index</i> is <math>LI = (w - PL) / PI</math> is an indicator of stress history; <math>LI &gt; 1</math> for normally consolidated (NC) soils and <math>LI &lt; 0</math> for over-consolidated (OC) soils. By and large, these are approximate and empirical values. They were originally developed for agronomic purposes. Their widespread use by engineers has resulted in the development of a large number of rough empirical relationships for characterizing soils.</p> <p>Considering the abstract and manual nature of the test procedure, Atterberg limits should only be performed by experienced technicians. Lack of experience, and lack of care will introduce serious errors in the test results.</p>

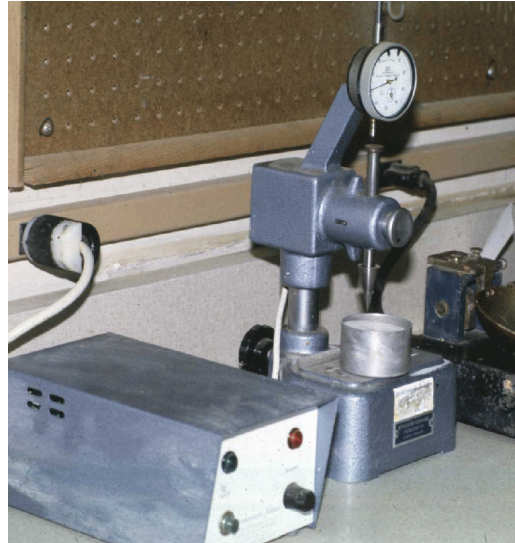


Figure 7-3. Liquid Limit Test by (a) Manual Casagrande Cup Device; (b) Electric Fall Cone.

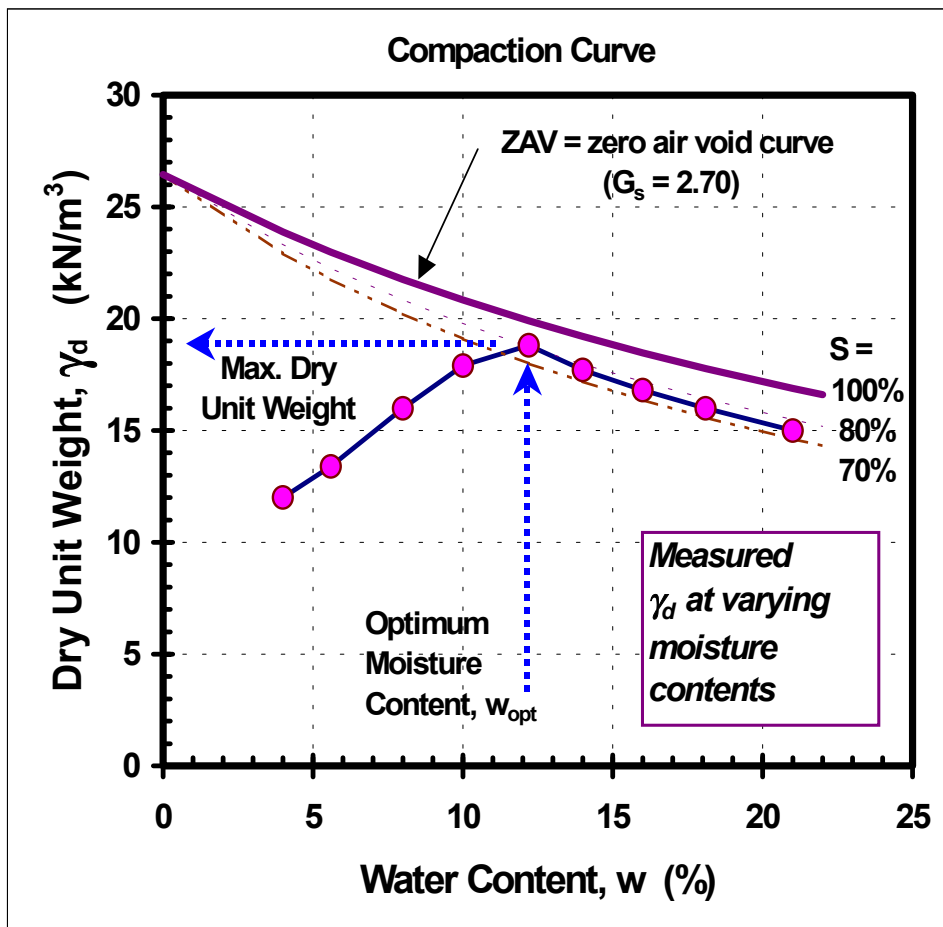


Figure 7-4. A Representative Moisture-Density Relationship from a Standard Compaction Test.

<b>Moisture-Density (Compaction) Relationship</b>	
AASHTO ASTM	T 99 (Standard Proctor), T 180 (Modified Proctor) D 698 (Standard Proctor), D 1557 (Modified Proctor)
Purpose	To determine the maximum dry density attainable under a specified nominal compaction energy for a given soil and the (optimum) moisture content corresponding to this density.
Procedure	Compaction tests are performed using disturbed, prepared soils with or without additives. Normally, soil passing the No. 4 sieve is mixed with water to form samples at various moisture contents ranging from the dry state to wet state. These samples are compacted in layers in a mold by a hammer in accordance with a specified nominal compaction energy. Dry density is determined based on the moisture content and the unit weight of compacted soil. A curve of dry density versus moisture content is plotted in Figure 7-4 and the maximum ordinate on this curve is referred to as the maximum dry density ( $\rho_{dmax}$ ). The water content at which this dry density occurs is termed as the optimum moisture content (OMC).
Commentary	<p>In the construction of highway embankments, earth dams, retaining walls, structure foundations and many other facilities, loose soils must be compacted to increase their densities. Compaction increases the strength and stiffness characteristics of soils. Compaction also decreases the amount of undesirable settlement of structures and increases the stability of slopes and embankments.</p> <p>The density of soils is measured as the unit dry weight, <math>\rho_d</math> (weight of dry soil divided by the bulk volume of the soil). It is a measure of the amount of solid materials present in a unit volume. The higher the amount of solid materials, the stronger and more stable the soil will be. To provide a “relative” measure of compaction, the concept of relative compaction is used. Relative compaction is the ratio (expressed as a percentage) of the density of compacted or natural in-situ soils to the maximum density obtainable in a compaction test. Often it is necessary to specify the achieving of a certain level of relative compaction (e.g. 95%) in the construction or preparation of foundations, embankments, pavement sub-bases and bases, and for deep-seated deposits such as loose sands. The design and selection of a placement method to improve the strength, dynamic resistance and consolidation characteristics of deposits depend heavily on relative compaction measurements.</p> <p>During the compaction of several specimens, the total unit weight of each compacted specimen is measured at each water content and the two soil identities used to obtain the needed parameters:</p> $(1) G_s w = S e, \text{ and}$ $(2) \rho_t = G_s \rho_w (1+w)/(1+e).$ <p>The dry unit weight is obtained as:</p> $\rho_d = \rho_t/(1+w).$ <p>It is also convenient to plot the zero air voids (ZAV) curve on the moisture-density graph, corresponding to 100 percent saturation (see Figure 7-4). The measured compaction curve response should not fall on or above this ZAV line. The maximum dry unit weight (“density”) found as the peak value often corresponds to saturation levels of between 70 to 85 percent.</p> <p>Where a variety of soils are to be used for construction, a moisture-density relationship for each major type of soil present at the site should be established.</p>

<b>Moisture-Density (Compaction) Relationship</b>	
AASHTO ASTM	T 99 (Standard Proctor), T 180 (Modified Proctor) D 698 (Standard Proctor), D 1557 (Modified Proctor)
	<p>When additives such as Portland cement, lime, or fly ash are used to determine the maximum density of mixed compacted soils in the laboratory, care should be taken to duplicate the expected delay period between mixing and compaction in the field. It should be kept in mind that these chemical additives start reacting as soon as they are added to the wet soil. They cause substantial changes in soil properties, including densities achievable by compaction. If in the field the period between mixing and compaction is expected to be three hours, for example, then in the laboratory the compaction of the soil should also be delayed three hours after mixing the stabilizing additives.</p> <p>Relative density (<math>D_R</math>) (ASTM D 4253) is often a useful parameter in assessing the engineering characteristics of granular soils and is defined as:</p> $D_R = 100 (e_{max} - e)/(e_{max} - e_{min}) \quad (7-4)$ <p>that can also be expressed in terms of dry unit weights. A greater discussion of <math>D_R</math> is given later in Chapter 9.</p>

<b>Classification of Soils</b>	
AASHTO ASTM	M 145 D 2487, D 3282
Purpose	To provide in a very concise manner information on the type and fundamental characteristics of soils, their utility as construction or foundation materials, their constituents, etc.
Procedure	See Section 4.6
Commentary	See Section 4.6

<b>Corrosivity of Soils</b>	
AASHTO ASTM	T 288, T 289, T 290, T 291 G 51, D 512, D 1125, D 2976, D 4230, D 4972
Purpose	To determine the aggressiveness and corrosivity of soils, pH, sulfate and chloride content of soils.
Procedure	Usually the pH of a soil material is determined electrometrically by a pH meter which is a potentiometer equipped with a glass-calomel electrode system calibrated with buffers of known pH. Measurements are commonly performed on a suspension of soil, water and/or alkaline (usually calcium chloride) solutions.
Commentary	Because of their environment or composition soils may have varying degrees of acidity or alkalinity, as measured by the pH test. Measurements of pH are particularly important for determining corrosion potential where metal piles, culverts, anchors, metal strips, or pipes are to be used. pH is also an important parameter for evaluating the durability of geosynthetics.

<b>Resistivity</b>	
AASHTO ASTM	T 288 G 57
Purpose	To determine the corrosion potential of soils.
Procedure	The laboratory test for measuring the resistivity of soils is performed using dried prepared soil passing the No. 8 screen. The soil is placed in a box approximately 10.2 cm x 15.2 cm x 4.5 cm with electrical terminals attached to the sides of the box such that they remain in contact with the soil. The terminals in turn are connected to an ohmmeter. A reading of the current passing through the dry soil is taken as the baseline reference resistance. The soil material is then removed and 50 ml to 100 ml of distilled water is added and thoroughly mixed, and placed back in the box. Another reading is taken. The conductivity (conductivity is the reverse of resistivity) of the soil as read by the ohmmeter increases as water is added. The procedure is repeated until the conductivity begins dropping. The highest conductivity, or the lowest resistivity, is used to compute the resistivity of the soil. The method is very sensitive to the distribution of water in the soils placed in the box. The resistivity may also vary significantly with the presence of soluble salts in soils.
Commentary	Where construction materials susceptible to corrosion are to be used in subgrades it is necessary to determine the corrosion potential of soils. This test is routinely performed for structures where metallic reinforcements, soil anchors, nails, culverts, pipes, or piles are included.

<b>Organic Content of Soils</b>	
AASHTO ASTM	T 194 D 2974
Purpose	To help classify the soil and identify its engineering characteristics.
Procedure	Oven-dried (at $110 \pm 5^\circ\text{C}$ ) samples <u>after</u> determination of moisture content are further gradually heated to $440^\circ\text{C}$ which is maintained until the specimen is completely ashed (no change in mass occurs after a further period of heating). The organic content is then calculated from the weight of the ash generated.
Commentary	<p>Organic materials affect the behavior of soils in varying degrees. The behavior of soils with low organic contents (&lt;20% by weight) generally are controlled by the mineral components of the soil. When the organic content of soils approaches 20%, the behavior changes to that of organic, or peaty soils. The consolidation characteristics, permeability, strength and stabilization of these soils are largely governed by the properties of organic materials. Thus it is important to determine the organic content of soils. It is not sufficient to simply label a soil as "organic" without showing the organic content.</p> <p>Organic soils are those formed throughout the ages at low-lying sediment-starved areas by the accumulation of dead vegetation and sediment. Top soils are very recently formed mixtures of soil and vegetation that form part of the food chain. Top soils are not suitable for use in construction and therefore its organic content is not usually determined.</p>

### 7.1.8 Strength Tests

The design and analysis of shallow and deep foundations, excavations, earth retention structures, and fills and slopes require a thorough understanding of soil strength parameters. The selection of strength parameters needed and the corresponding types of tests to be performed vary depending on the type of construction, the foundation design, the intensity, type and duration of loads to be imposed, and soil materials existing at the site.

The shear strength should be determined by a combination of both field and laboratory tests. Lab tests provide reference strengths under controlled boundaries and loading. However, limited quality samples are obtained from the field, particularly for sandy materials. The interpretation of strength from in-situ tests in sands and clays is important and discussed in Chapter 9.

For clays, commonly used laboratory tests include the unconfined compression (UC) and unconsolidated undrained tests (UU), however, these do not attempt to replicate the ambient stress regime in the ground prior to loading and therefore can only be considered as index strengths. Preferably, the consolidated triaxial shear and direct shear box tests can be used in conjunction with consolidation/oedometer tests in a normalized stress history approach (Ladd & Foott, 1974; Jamiolkowski, et al. 1985).

Both undisturbed and remolded or compacted samples are used for strength tests. Where soils are to be disturbed and remolded, compacted or stabilized specimens are tested for strength determination at specified moisture contents and densities. These may be chosen on the basis of design requirements or the in-situ density and moisture content of soils. Where obtaining undisturbed samples is not practical (i.e., sandy and gravelly soils), specimens remolded close to their natural moisture content and density are prepared for testing.

#### Total and Effective Stress Analysis

Soils are controlled by the effective stress strength envelope ( $c_f$  and  $N_f$ ) and therefore the proper determination of these parameters is paramount. The strength envelope is best determined by either a series of (1) consolidated undrained triaxial shear tests with porewater pressure measurements (CU); (2) consolidated drained triaxial tests at slow strain rates (CD); or (3) drained direct shear tests (DDS). For long-term analyses, the drained parameters are equal to effective cohesion intercept  $c_f$  and effective friction angle  $N_f$  from the effective stress Mohr-Coulomb envelope (see Figure 7-5). The shear strength ( $J_{max}$ ) is given by:

$$J_{max} = c_f + F_N \sigma_v \tan N_f \quad (7-5)$$

Usually,  $c_f = 0$  is adopted because lab tests are affected by rate & duration effects and  $c_f$  is a bond that weathers with time (e.g., Mesri & Abdel-Ghaffar, 1993). Effective strength parameters apply to all soil types, including gravels, sands, silts, and clays.

The stress dependency of soil can be characterized by the stress path method. A stress path gives a numerical and graphical representation of the past, present and future state of stress on a representative soil element. It captures the geologic stress history of the element, the current stresses acting on the element, and the anticipated future changes in stress on the element. The stress path method determines what these stresses are, subjects representative elements of soil to these stress paths, and measures the resulting mechanical behavior of the soil. The measurements are used to determine strength, compressibility and permeability for specific stress paths. These stress path dependent mechanical properties are then used in analysis and design to predict the future performance of a constructed facility.

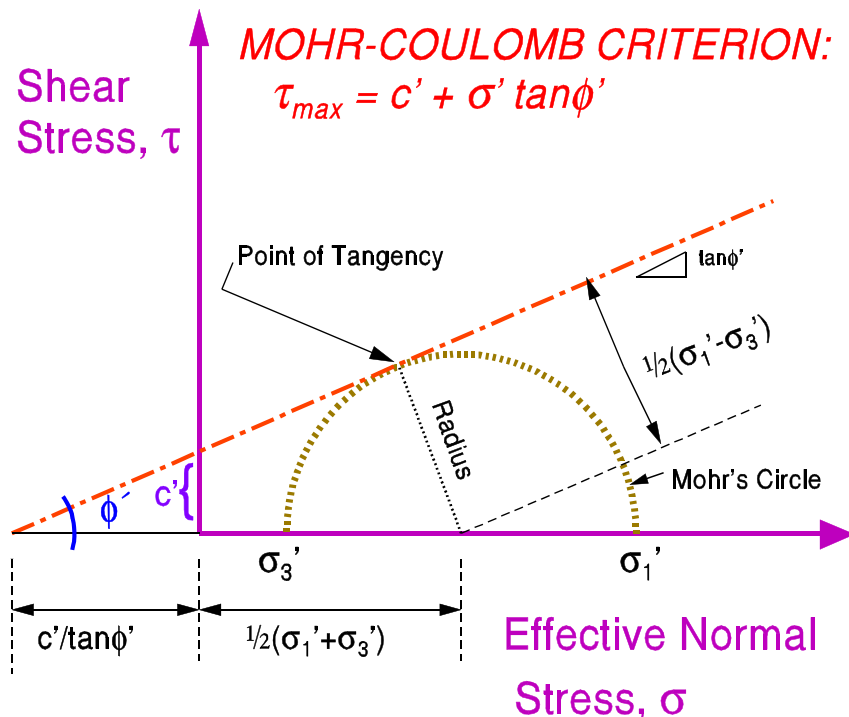


The triaxial test results can be used to develop the “stress path” of the soil under the test conditions by plotting the effective strength for each load increment from the start to finish of the test. Using the stress path method, the test results can then be analyzed with respect to the approximate field stress and strain conditions before, during, and after construction (Lambe, 1967 and Lambe and Marr, 1979).

For short-term loading of clays & silts, total stress analysis uses the undrained shear strength (designated  $s_u$  or  $c_u$ )<sup>1</sup> that is a soil behavioral response that reflects the combination of the effective stress frictional envelope ( $c_f$  and  $N_f$ ) plus excess porewater pressures that depend on stress history. From this regard, perhaps the simple shear is the most appropriate test for stability & bearing capacity analyses, however, the device is not in widespread use in the U.S. Other modes of  $s_u$  include triaxial compression & extension, plane strain active & passive, true triaxial, hollow cylinder, and directional shear, all of which provide different values of  $s_u$  depending upon the boundary conditions, direction of loading, strain rate, and initial stress state. As this is a complex issue, the best value is calculated from the normalized value (Jamioolkowski, et al., 1985):

$$s_u / F_{v0} r = 0.5 \sin N_f \text{OCR}^{0.8} \quad (7-6)$$

For extensively fissured clays and tills, the macrofabric of discontinuities reduces the overall strength and (7-6) should be reduced by a factor of 2. In the case of fissured geomaterials, it is also common that these exhibit past problems with landsliding and slope instability, therefore the drained strength parameters may be more appropriately assigned to the residual values ( $c_r$  and  $N_r$ ). Residual strengths can be determined by ring shear tests or series of repeated drained direct shear box tests (Lupini, et al. 1981).



**Figure 7-4. Definitions of Effective Stress Parameters For Mohr-Coulomb Failure Criterion.**

<sup>1</sup> Note: The old archaic term “cohesion” designated “c” has been replaced with undrained shear strength.

**Unconfined Compressive Strength of Soils**

AASHTO ASTM	T 208 D 2166
----------------	-----------------

**Purpose** To determine the undrained shear strength ( $c_u$ ) of clay and silty clay soils.

**Procedure** The soil specimens are tested without any confinement or lateral support ( $F_3=0$ ). Axial load is rapidly applied to the sample to cause failure. At failure the total minor principal stress is zero ( $F_3 = 0$ ) and the total major principal stress is  $F_1$  (see Figure 7-6). The maximum measured force over the sample area is  $q_u$  and referred to as the unconfined compression strength. Since the undrained strength is independent of the confining pressure,  $c_u = q_u/2$ .

Axial Strain, $\epsilon_a$ (%)	Axial Stress, $\sigma_a$ (kPa)
0	0
0.2	10
0.4	20
0.6	30
0.8	45
1.0	60
1.2	75
1.4	85
1.6	95
1.8	102
2.0	100
2.5	95
3.0	90
3.5	88
4.0	85
4.5	82
5.0	80

**Figure 7-6. Measured Stress-Strain for Unconfined Compressive Test.**

**Commentary** The determination of unconfined compressive strength of undisturbed, remolded or compacted soils is limited to cohesive or naturally or artificially cemented soils. Application of this test to non-cohesive soils may result in underestimation of the shear strength. The test is inexpensive and requires a relatively short period of time to complete. However, due to the absence of lateral pressures and lack of control over pore pressures, it has major inaccuracies.

The stress-strain curves and failure modes observed during testing provide an index value of the soil properties in addition to strength. For example, an ill-defined failure or yielding of the sample signifies a relatively soft, fat clay, while a sudden brittle failure indicates that of a desiccated clay or cemented material. The stress-strain curves developed from these tests should be used with caution when determining soil modulus for input to numerical analyses, such as finite element analysis, which are very sensitive to minor variations of the modulus.

Soils with inclined fissures, sand & silt lenses and slickensides have a tendency to fail prematurely along these weaker planes in unconfined compression tests. It is essential that such failure modes be reported to the geotechnical engineer, who may request further more sophisticated testing such as triaxial tests to obtain more realistic determination of the in situ strength.

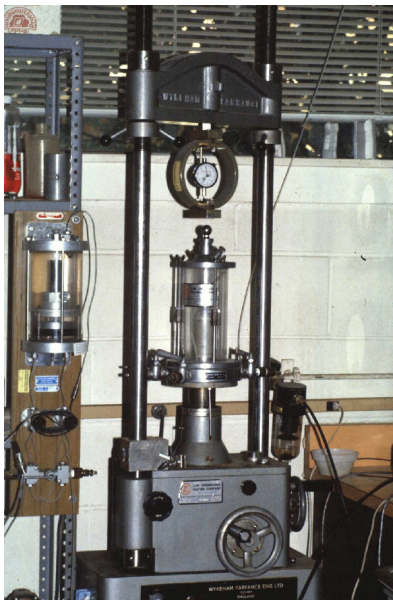
<b>Triaxial Strength</b>	
AASHTO ASTM	T 296, T 297 D 2850, D 4767
Purpose	To determine strength characteristics of soils including detailed information on the effects of lateral confinement, porewater pressure, drainage and consolidation. Triaxial tests provide a reliable means to determine the friction angle of natural clays & silts, as well as reconstituted sands. The stiffness (modulus) at intermediate to large strains can also be evaluated.
Procedure	<p>The triaxial test set-up is shown in Figure 7-7. Test samples are typically 35 to 75 mm in diameter and have a height to length ratio between 2 and 2.5. The sample is encased by a thin rubber membrane and placed inside a plastic cylindrical chamber that is usually filled with water or glycerine. The sample is subjected to a total confining pressure (<math>F_3</math>) by compression of the fluid in the chamber acting on the membrane. A backpressure (<math>u_0</math>) is applied directly to the specimen through a port in the bottom pedestal. Thus, the sample is initially consolidated with an effective confining stress: <math>F_3 r = (F_3 - u_0)</math>. (Note that air should not be used as a compression medium). To cause shear failure in the sample, axial stress is applied through a vertical loading ram (commonly called <i>deviator stress</i> = <math>F_1 - F_3</math>). Axial stress may be applied at a constant rate (strain controlled) or by means of a hydraulic press or dead weight increments or hydraulic pressure (stress controlled) until the sample fails.</p> <p>The axial load applied by the loading ram corresponding to a given axial deformation is measured by a proving ring or electronic load cell attached to the ram. Connections to measure drainage into or out of the sample, or for porewater pressure are also provided. Deflections are monitored by either dial indicators, LVDTs, or DCDTs.</p>
Commentary	<p>In general, there are five types of triaxial tests:</p> <ul style="list-style-type: none"> <li>C Undrained Unconsolidated (UU test)</li> <li>C Consolidated Undrained (CU test)</li> <li>C Consolidated Drained (CD test)</li> <li>C Consolidated Undrained with pore pressure measurement (<b>66</b>)</li> <li>C Cyclic Triaxial Loading Tests (CTX)</li> </ul> <p>In a UU test, the samples are not allowed to drain or consolidate prior to or during the testing. The results of undrained tests depend on the degree of saturation (S) of the specimens. Where S=100%, the test results will provide a value of undrained shear strength (<math>s_u</math>), however, the test is affected by sample disturbance and rate effect (Ladd, 1991). This test is not applicable for granular (S=100%) soils.</p> <p>The (<b>66</b>) test with porewater pressure measurements is the most useful as it provides a direct measure of the undrained shear strength (<math>s_u</math>), for triaxial compressive mode, as well as the important effective stress parameters (<math>c\tau</math> and <math>Nr</math>). The CD tests also provide the parameters <math>c\tau</math> and <math>Nr</math>. Cyclic triaxial tests are used for projects with repeated and/or cyclic loading, resilient modulus determinations, and/or liquefaction analysis of soils. In each of these tests, the specimen is initially consolidated to the effective vertical overburden stress (<math>F_{vo}r</math>) prior to shear. If additional specimens from the same tube are tested, these may be tested at confining stress levels of 0.5 (<math>F_{vo}r</math>) to 1.5 (<math>F_{vo}r</math>), in order to provide a range of operating values.</p> <p>The results can be presented in terms of Mohr Circles of stress to obtain the strength parameters (Figure 7-8). If more than two or three tests are conducted, the results are more conveniently plotted on q-p space, where <math>q = \frac{1}{2}(F_1 - F_3)</math> and <math>p r = \frac{1}{2}(F_1 r + F_3 r)</math>, as illustrated in Figure 7-9. In addition, the entire stress path from start to finish can be followed</p>



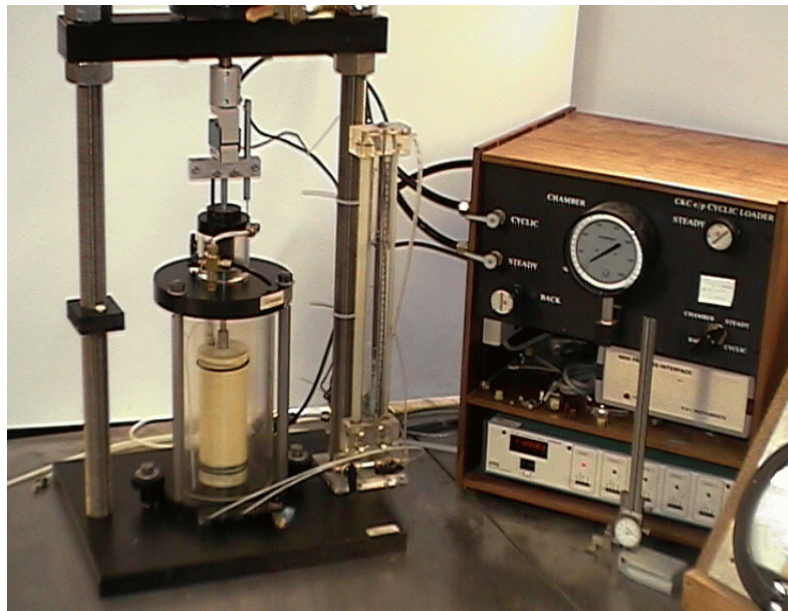
(a)



(b)



(c)



(d)

**Figure 7-7. Triaxial Test Apparatuses and Equipment:**

(a) Specimen Being Consolidated in Triaxial Cell Prior to Shear; (b) Automated Cyclic Triaxial Equipment (Geocomp Corp); (c) Mechanical Gear-Driven Load Frame and Triaxial System (Wykeham Farrance Ltd.); (d) Controlled Triaxial System for Isotropic and/or  $K_0$ -Consolidated Triaxial Compression and Extension Testing (CKC System).

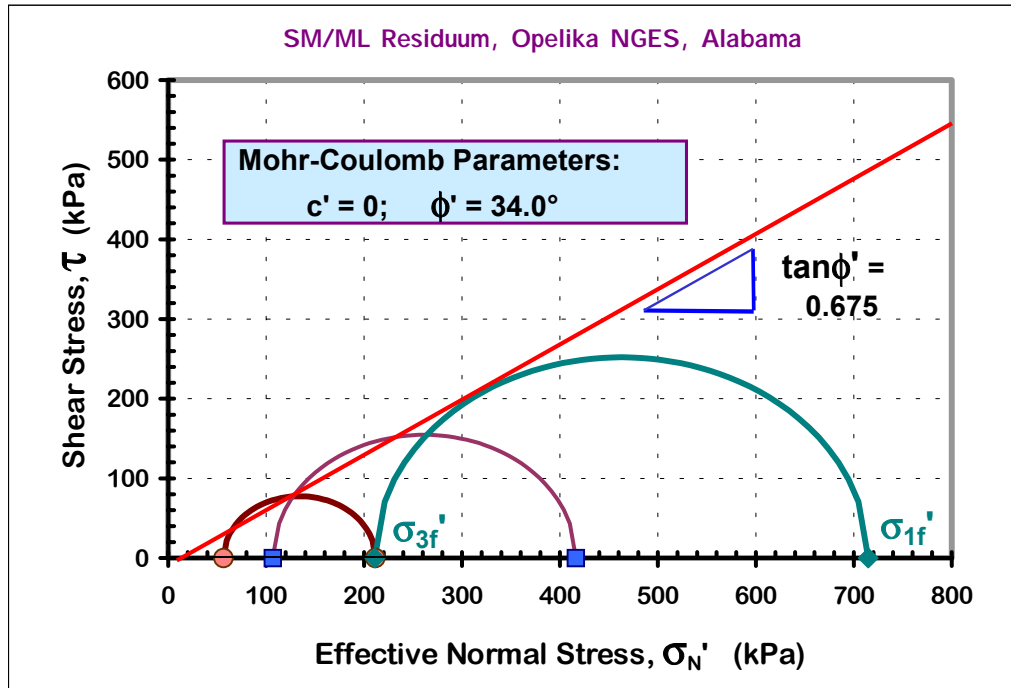
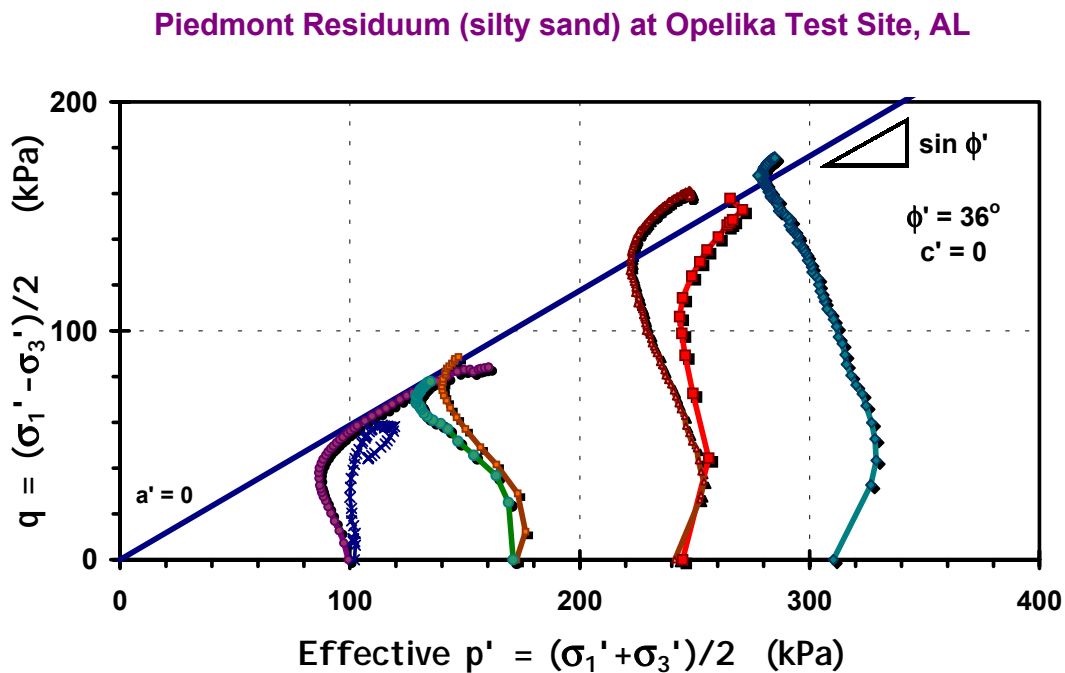


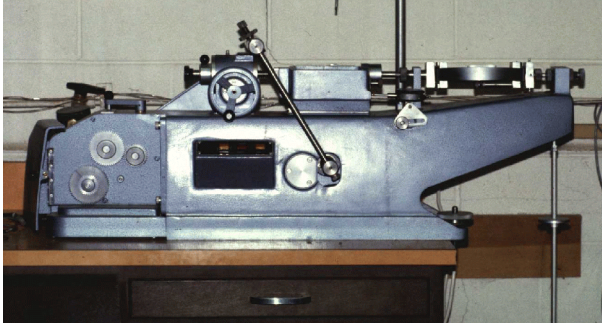
Figure 7-8. Effective Stress Mohr Circles for Consolidated Undrained Triaxial Tests.



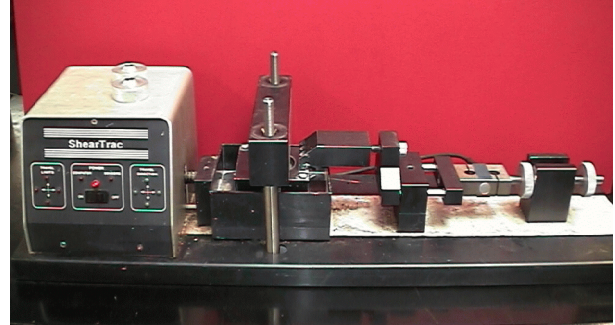
Mohr Coulomb Strength Parameters: Intercept  $a' = c' \cos \phi'$ ; Slope:  $\tan \alpha = \sin \phi'$

Figure 7-9. Effective  $q$ - $p'$  Strength Envelopes for Consolidated Undrained Triaxial Tests.

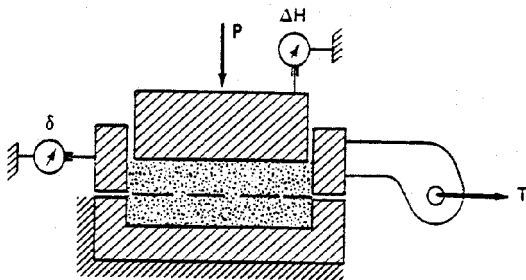
<b>Direct Shear</b>	
AASHTO ASTM	T 236 D 3080
Purpose	To determine the shear strength of soils along a pre-defined (horizontal) planar surface
Procedure	The direct shear (DS) test is performed by placing a specimen into a cylindrical or square-shaped shear box which is split in the horizontal plane. DS devices are shown in Figure 7-10. A vertical (normal) load is applied over the specimen that is allowed to consolidate. While either the upper or lower part of the box is held stationary, a horizontal load is exerted on the other part of the box in an effort to shear the specimen on a predefined horizontal plane. The test is repeated at least three times using different normal stresses ( $F_N/r$ ). The results are plotted in the form shear stress ( $J$ ) vs. horizontal displacement ( $*$ ), and corresponding $J$ vs. $F_N/r$ . The effective cohesion intercept and angle of internal friction values can be determined from this latter plot.
Commentary	<p><b>Direct Shear (Box) Test</b></p> <p>The DS test is the oldest and simplest form of shear test arrangement. It has several inherent shortcomings due to the forced plane of shearing:</p> <ul style="list-style-type: none"> <li>C The failure plane is predefined and horizontal; this plane may not be the weakest.</li> <li>C As compared to the triaxial test, there is little control over the drainage of the soil.</li> <li>C The stress conditions across the soil sample are very complex. The distribution of normal stresses and shearing stresses over the sliding surface is not uniform; typically the edges experience more stress than the center. Due to this, there is progressive failure of the specimen, i.e., the entire strength of the soil is not mobilized simultaneously.</li> </ul> <p>In spite of the above shortcomings, the direct shear test is commonly used as it is simple and easy to perform. The device uses much less soil than a standard triaxial device, therefore consolidation times are shorter. The DS provides reasonably reliable values for the effective strength parameters, <math>c_f</math> and <math>N_f r</math>, provided that slow rates of testing are utilized (see Figure 7-11).</p> <p>Repeated cycles of shearing along the same direction provide an evaluation of the residual strength parameters (<math>c_r</math> and <math>N_r r</math>). The direct shear test is particularly applicable to those foundation design problems where it is necessary to determine the angle of friction between the soil and the material of which the foundation is constructed, e.g., the friction between the base of a concrete footing and underneath soil. In such cases, the lower box is filled with soil and the upper box contains the foundation material.</p> <p><b>Direct Simple Shear (DSS) Test</b></p> <p>The DSS test was developed in an attempt to refine the direct shear test by providing shear strain distortion, rather than horizontal displacement. Earlier DSS test devices used a cylindrical specimen confined in rubber membrane reinforced with a series of evenly spaced rigid rings. Later versions developed by the Norwegian Geotechnical Institute (NGI) used square specimens with hinged end plates that could tilt to maintain fixed specimen length during shearing. The NGI version is used by a number of European geotechnical agencies. Some of the studies performed show that this device provides a means of studying plane strain (i.e., embankment loads). Studies at MIT, NGI, Swedish Geotechnical Institute, and Politecnico di Torino have concluded that the DSS provides the most representative mode for the mobilized undrained strength in stability analyses involving embankments, footings, and excavations in soft ground.</p>



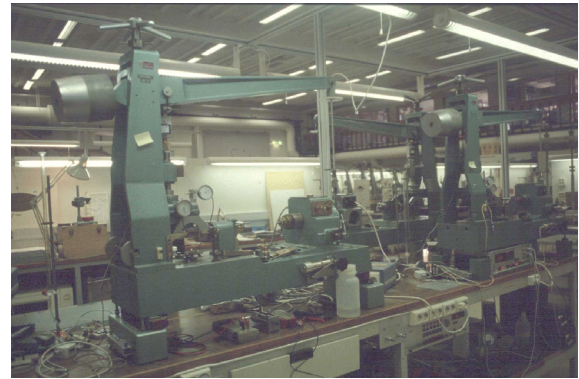
(a)



(b)

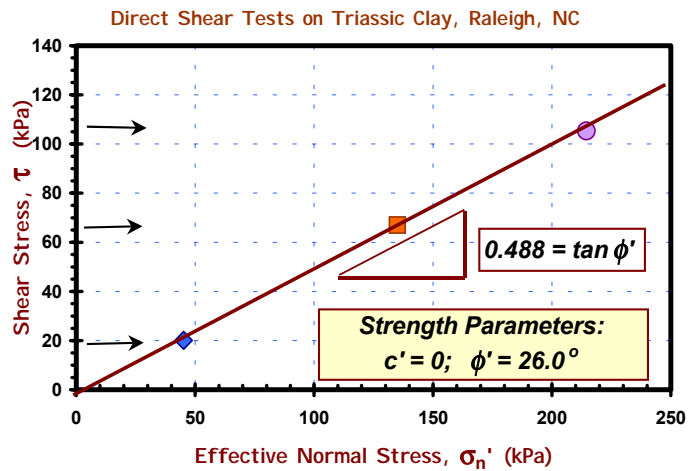
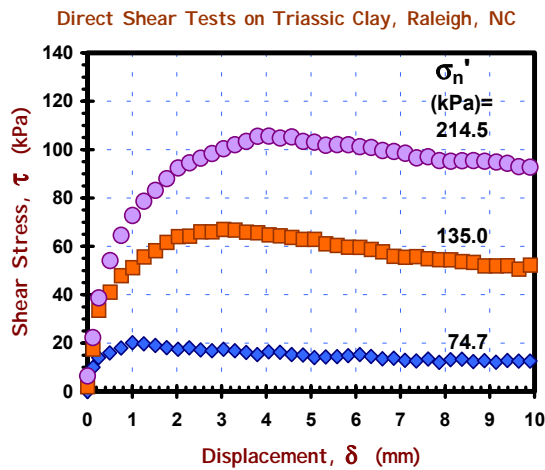


(c)



(d)

**Figure 7-10. Direct Shear Test Devices:** (a) Mechanical Wykeham Farrance Device; (b) Electro-Mechanical ShearTrac (GeoComp Corp) ; (c) Shear Box Cross-Section; (d) NGI Direct Simple Shear.



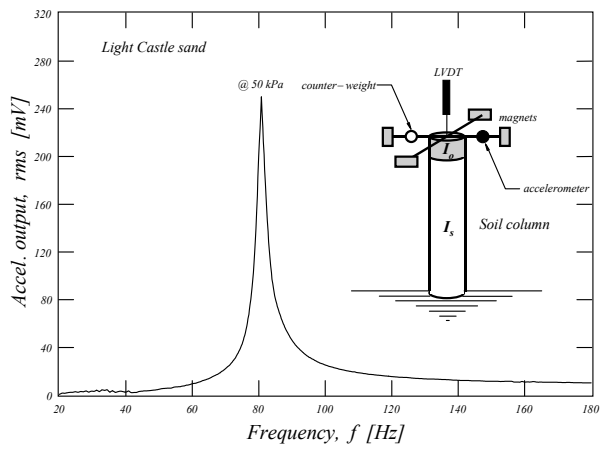
**Figure 7-11. Illustrative Results from DS Tests on Clay Involved in Route 1 Slope Stability Study, Raleigh, NC.**

<b>Resonant Column</b>	
ASTM	D 4015
Purpose	To determine the shear modulus ( $G_{\max}$ or $G_0$ ) and damping ( $D$ ) characteristics of soils at small strains for cases where dynamic forces are involved, particularly seismic ground amplification and machinery foundations. Recent research has shown the results are also applicable to static loading at very small strains ( $< 10^{-6}$ percent); for example (Burland, 1989).
Procedure	Prepared cylindrical specimens are placed in an special triaxial chamber and consolidated to ambient overburden stresses (Figure 7-12). Very low amplitude torsional vibrations are applied to one end of the specimen by use of a special loading cap with electromagnetics. The resonant frequency, damping, and strain amplitudes are measured by the use of motion transducers (Woods, 1994).
Commentary	<p>The resonant column test (RCT) requires a high-caliber laboratory setup with special care in calibration and maintenance of frequency-domain electronics (e.g., spectrum analyzer). The fundamental measurement of shear wave velocity (<math>V_s</math>) provides the small-strain shear modulus:</p> $G_{\max} = D_T (V_s)^2 \quad (7-7)$ <p>where <math>D_T = \rho_T/g</math> = total soil mass density and <math>g = 9.8 \text{ m/s}^2</math> = gravitational acceleration constant. Although field methods such as the crosshole, downhole, surface wave, and suspension logging techniques provide direct in-situ measurements of <math>V_s</math>, the RCT is advantageous in that it can evaluate the variation (decrease) of <math>G_{\max}</math> with increasing shear strain (<math>\gamma</math>), as well as the increase of damping (<math>D</math>) with <math>\gamma</math>, as illustrated in Figure 7-13. There are however significant time (soil aging) effects, which can lead to lower values than obtained in the field.</p> <p>Generally, the RCT is considered a nondestructive test and the material properties are essentially unchanged during the small-strain torsional loading. Therefore, it is common that the same specimen can be subjected to several levels of effective confining stress. Over three decades experience with the RCT on soils indicates that <math>G_{\max}</math> is a function of void ratio (<math>e</math>) and mean effective confining stress, <math>F_o' = 1/3(F_{vo}r+2 F_{ho}r)</math>, as well as cementation, aging, saturation, and other factors. A well-known expression is:</p> $G_{\max} = (625/e^{1.3})(F_{ATM} F_o')^{0.5} OCR^5 \quad (7-8)$ <p>where <math>5 = (PI^{0.72})/50</math> and <math>F_{ATM}</math> = atmospheric pressure (1 bar . 100 kPa . 1 tsf).</p>

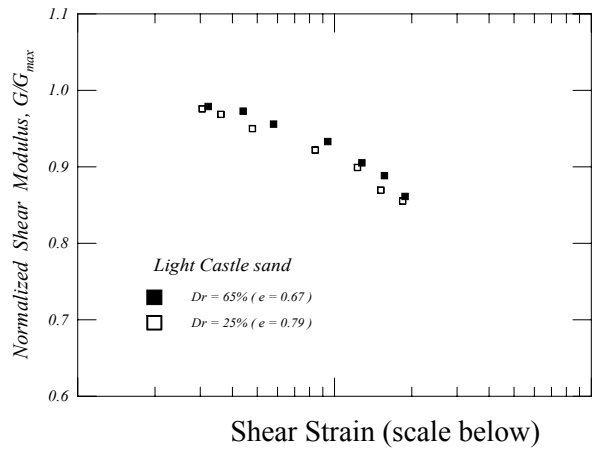


**Figure 7-12. Resonant Column Test (RCT) Equipment for Determining  $G_{\max}$  and  $D$  in Soils.**

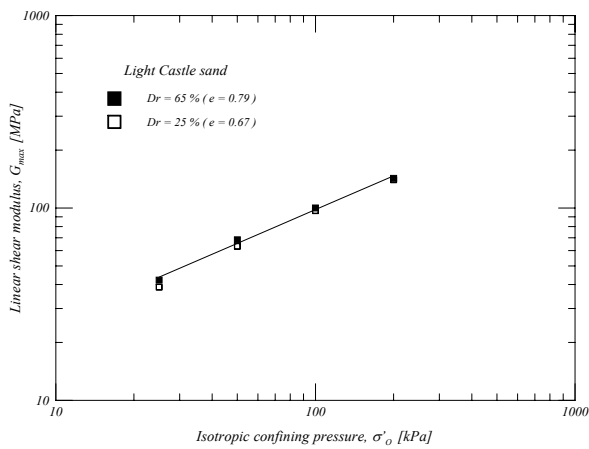




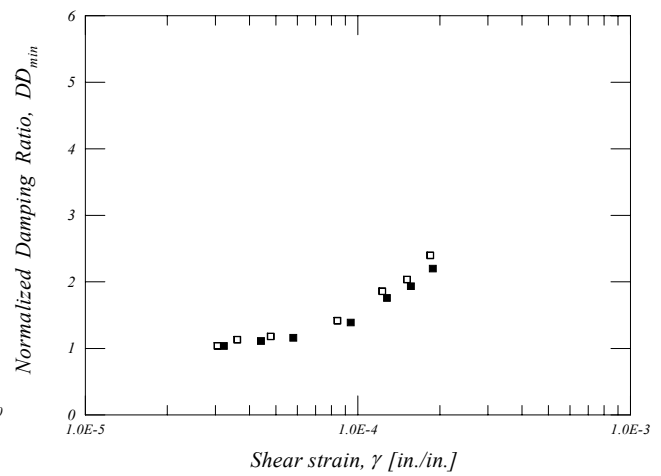
(a)



(b)



(c)



(d)

**Figure 7-13. Results from Resonant Column Testing of Light Castle Sand:**  
 (a) Measured Resonance at a Given Effective Confining Stress and Shear Strain;  
 (b) Normalized Modulus Reduction ( $G/G_{max}$ ) with Shear Strain; (c) Variation of Small-Strain Shear Modulus ( $G_{max}$ ) with Effective Confining Stress Level; and (d) Damping Ratio ( $D$ ) increase with Shear Strain.

<b>Miniature Vane</b>	
AASHTO ASTM	- D 4648
Purpose	To determine the undrained shear strength ( $s_u$ ) and sensitivity ( $S_t$ ) of saturated clays and silts
Procedure	The test is performed by inserting a four-bladed vane into the soil and applying rotation to shear a cylindrical surface. The undrained shear strength is computed from the measured torque (see Chapter 5). The miniature vane is similar to the field vane shear device, except that it is smaller (blade diameter 12.7 mm, blade height 25.4 mm).
Commentary	<p>The test assumes that the stresses applied are limited to the cylindrical surface represented by the diameter and the height of the vane. This is hardly the case in reality. Depending on the strength and stiffness, the soils in an area radiating outward from the surface of the idealized cylindrical zone are also disturbed by the shearing action of the vane. A portion of the torque therefore is used to mobilize this zone. Thus the assumption that the only sheared zone is the one defined by the outline of the vane blades introduces varying degrees of error.</p> <p>The analysis of the test assumes that strength of the soil being tested is isotropic, which is not true for all deposits. The test, however, can be a useful tool for measuring anisotropy and remolded strength of saturated clays and silts. The ratio of peak to remolded undrained strengths is the <i>sensitivity</i> (<math>S_t</math>). The laboratory vane shear test should be used as an index test.</p>

<b>California Bearing Ratio (CBR)</b>	
AASHTO ASTM	T 193 D 4429 (for field); D 1883 (for laboratory)
Purpose	To determine the bearing capacity of a compacted soil under controlled moisture and density conditions.
Procedure	<p>The test results are expressed in terms of a bearing ratio which is commonly known as the California Bearing Ratio (CBR). The CBR is obtained as the ratio of the unit load required to cause a certain depth of penetration of a piston into a compacted specimen of soil at some water content and density, to the <i>standard unit load</i> required to obtain the same depth of penetration on a standard sample of crushed stone (usually limestone). Typically soaked conditions should be used to simulate anticipated long-term conditions in the field.</p> <p>The CBR test is run on three identically compacted samples. Each series of the CBR test is run for a given relative density and moisture content. The geotechnical engineer must specify the conditions (dry, at optimum moisture, after soaking, 95% relative density, etc.) under which each test should be performed.</p>
Commentary	CBR is a practical bearing capacity test, yet provides only discrete point test data for evaluation. Most CBR testing is laboratory-based, thus the results will be highly dependent on the representativeness of the samples tested. The test results are used for highway, airport, parking lot and other pavement designs using empirical local or agency-specific methods (i.e., FHWA, FAA, AASHTO). More often than not, pavement failures are due to poor drainage, overloaded truck traffic, increased overall road traffic, and wear.

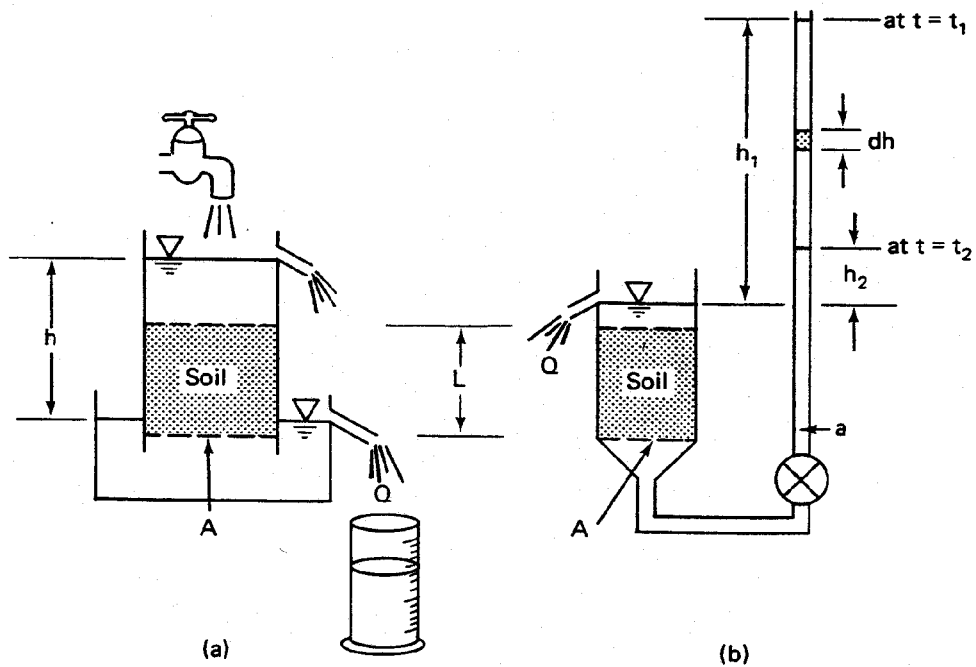
<b>R-Value Test</b>	
AASHTO ASTM	T 190 D 2844
Purpose	To determine the ability of a soil to resist lateral deformation when a vertical load acts upon it. The resistance is indicated by the R-value.
Procedure	<p>Measuring the R-value of a soil is done with a stabilometer. A stabilometer is similar to a triaxial device consisting of a metal cylinder in which there is a rubber membrane; the annular space between the two is filled with oil that transmits lateral pressure to the specimen.</p> <p>Compacted, unstabilized or stabilized soils and aggregates, can be used in these tests. Samples are compacted using a special kneading compaction device. When the specimen is vertically loaded, a lateral pressure is transmitted to the soil, which can be measured on a pressure gage. From the displacement measured for a specified lateral pressure, the R-value is determined.</p>
Commentary	<p>The R-Value test was developed by the California Division of Highways for use in the empirical design method developed by them. Later it was widely adopted for use in pavement design. The kneading compactor used to prepare the test samples is considered to more closely model the compaction mode of field equipment by its kneading action. Specimens fabricated by this method develop internal structures more representative of actual field compacted materials where soil particles are kneaded together rather than densified by impact force.</p> <p>The R-Value is used either directly or translated into more common factors (i.e., CBR) through correlation charts to be used with other more common design methods (i.e., AASHTO). This test method indirectly measures the strength of pavement materials by measuring the resistance to deformation under lateral and normal stresses.</p> <p>The test also allows the measurement of swell pressure of expansive soils. The strength data is used in the design of pavements to determine the thickness of various components of pavement structures. The swell pressure or expansion pressure data is used in determining the suitability of expansive soils for use under pavements and the intensity of stress needed, in the form of overburden, to control the expansion of these soils.</p>

<b>Resilient Modulus</b>	
AASHTO ASTM	T 294 -
Purpose	To determine the approximate relationships between applied stress and deformation loading of pavement component materials.
Procedure	A compacted or undisturbed cylindrical specimen is placed in an oversized triaxial chamber. An axial deviator stress of constant magnitude and duration and frequency is applied at the same time that a lateral stress is maintained in the triaxial chamber. The recoverable or resilient axial strain of the specimen is measured for varying increments of axial stresses.
Commentary	The test is time-consuming and requires special test and laboratory setup. One specimen can be used for a variety of axial loads. Both undisturbed and disturbed specimens representing the pavement materials can be used. Sample preparation of remolded specimens requires a thorough appreciation of the existing or expected field conditions. Values obtained can be used to determine the linear or non-linear elastic response of pavement component materials.

### 7.1.9 Permeability

The hydraulic conductivity or permeability is an important flow property of soils.

<b>Permeability of Soils</b>	
AASHTO ASTM	T 215 D 2434 (Granular Soils), D 5084 (All Soils)
Purpose	To determine the potential of flow of fluids through soils.
Procedure	<p>The ease with which a fluid passes through a porous medium is expressed in terms of coefficient of <i>permeability</i> (<math>k</math>), also known as <i>hydraulic conductivity</i>. There are two basic standard types of test procedures to directly determine permeability: (1) constant-head; and (2) falling-head procedures (see Figure 7-14).</p> <p>In both procedures, undisturbed, remolded, or compacted samples can be used. The permeability of coarse materials is determined by constant head tests. The permeability of clays is normally determined by the use of a falling head permeameter. The difference between the two tests is that in the former, the hydraulic gradient of the specimen is kept constant, while in the latter, the head is allowed to decrease as the water permeates the specimen. Evaluations of soil permeability are obtained from time readings required for a measured volume of water to pass through the soil as shown in Figure 7-14.</p>
Commentary	<p>Permeability is one of the major parameters used in selecting soils for various types of construction. In some cases it may be desirable to place a high-permeability material immediately under a pavement surface to facilitate the removal of water seeping into the base or sub-base courses. In other cases, such as retention pond dikes, it may be detrimental to use high-permeability materials. Permeability also significantly influences the choice of backfill materials.</p> <p>Both test procedures determine permeability of soils under specified conditions. The geotechnical engineer must establish which test conditions are representative of the problem under consideration. As with all other laboratory tests, the geotechnical engineer has to be aware of the limitations of this test. The process is sensitive to the presence of air or gases in the voids and in the permeant or water. Prior to the test, distilled, de-aired water should be run through the specimen to remove as much of the air and gas as practical. It is a good practice to use de-aired or distilled water at temperatures slightly higher than the temperature of the specimen. As the water permeates through the voids and cools, it will have a tendency to dissolve the air and some of the gases, thus removing them during this process. The result will be a more representative, albeit idealized, permeability value.</p> <p>The type of permeameter, (i.e., flexible wall - ASTM D 5084 -versus rigid - ASTM D 2434 and AASHTO T215) may also affect the final results. For testing of fine-grained, low-permeability soils, the use of flexible-wall permeameters is recommended which are essentially very similar to the triaxial test apparatus (see Figure 7-15). When rigid wall units are used, the permeant may find a route at the sample-permeameter interface, thus it may drain through that interface rather than travel through the specimen. This will produce erroneous results.</p> <p>It should be emphasized that permeability is sensitive to viscosity. In computing permeability, the correction factors for viscosity and temperatures should be applied. During testing, the temperature of the permeant and the laboratory should be kept constant.</p> <p>Laboratory permeability tests produce reliable results under ideal conditions. Permeability of fine-grained soils can also be computed from one-dimensional consolidation test results, although these results are not as accurate as direct <math>k</math> measurements (e.g., Tavenas, et al. 1983).</p>



Computation of Coefficient of Permeability, k

For *Constant Head Test* (Figure a):

$$k = \frac{QL}{hAt} \quad (7-9)$$

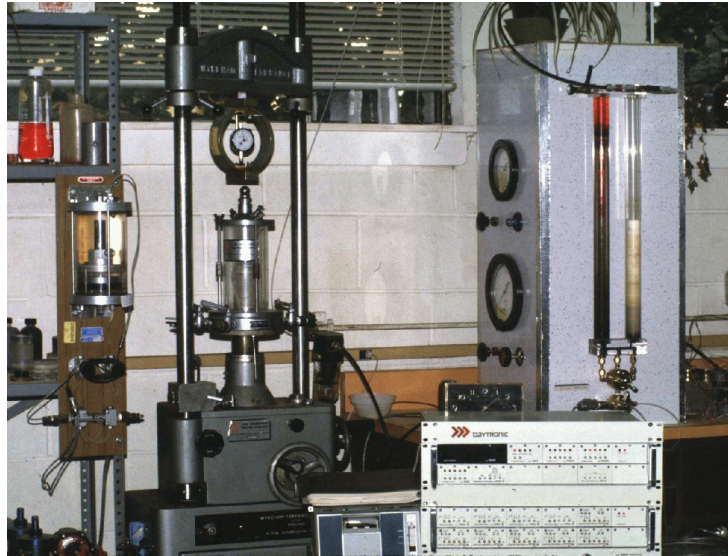
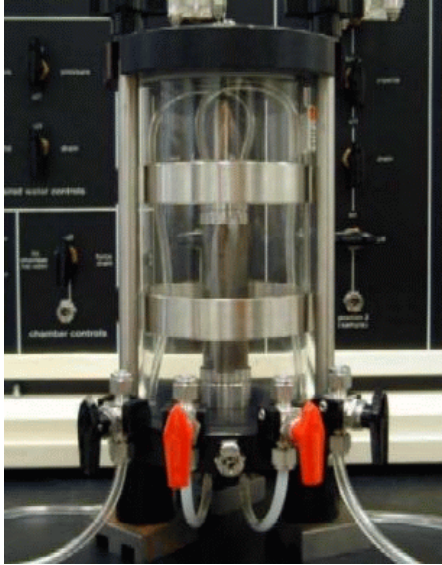
where  $Q$  = total discharge volume,  $m^3$ , in time,  $t$  (seconds), and  
 $A$  = cross-sectional area of soil sample,  $m^2$

For *Falling Head Test* (Figure b)

$$k = 2.3 \frac{aL}{A \Delta t} \log_{10} \frac{h_1}{h_2} \quad (7-10)$$

where  $a$  = area of standpipe,  
 $A, L$  = soil sample area and length,  
 $t$  = time for standpipe head to decrease from  $h_1$  to  $h_2$ .

**Figure 7-14. Permeability Test Schematics: (a) Constant Head Device; (b) Falling Head Test.**



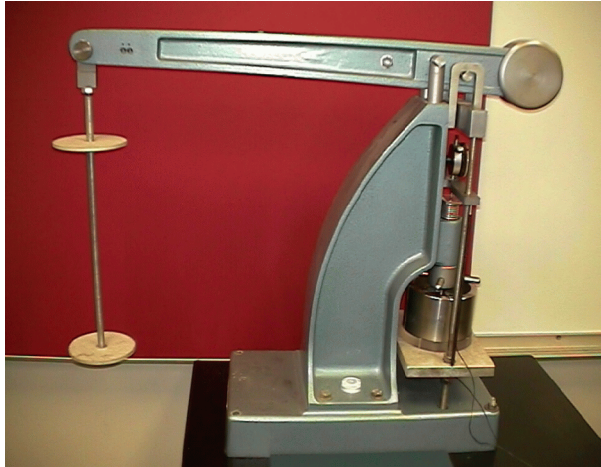
**Figure 7-15. Permeameter Equipment: (a) Flexible-Walled Permeameter Cell; (b) Permeability Station with Automatic Volume Change Device (left) and Backpressure Panel Board (right side).**

### 7.1.10 Consolidation

The one-dimensional *consolidation* test (or *oedometer* test) provides one of the most useful and reliable laboratory measurements for soil behavior. The test determines the compressibility parameters ( $C_c$ ,  $C_s$ ,  $C_r$ ), stiffness in terms of constrained modulus ( $D\gamma = 1/m_v$ ), preconsolidation stress ( $F_p\gamma$ ), rate of consolidation ( $c_v$ ), creep rate ( $C^*$ ), and approximate value of permeability ( $k$ ).

<b>One-Dimensional Consolidation</b>	
AASHTO ASTM	T 216 D 2435
Purpose	Determination of preconsolidation stress, compression characteristics, creep, stiffness, and flow rate properties of soils under loading.
Procedure	<p>The test is performed using a small 50-mm to 75-mm diameter thin specimen (25 mm thick) taken from an undisturbed sample. Selection of representative samples for testing is critical. Prepared samples are placed in a rigid-walled loading device called a consolidometer or oedometer (see Figure 7-16). All loads and recorded deformations are in the vertical direction.</p> <p>The specimen is subjected to incremental loads, which are doubled after each equilibrium phase is reached (after <math>t_p</math> corresponding to the end of primary consolidation). Tradition would use a 24-hour increment per load, although this is conservative. Alternatively, specimens can be loaded continuously with monitoring by load cells and porewater pressure transducers.</p> <p>Generally, it is desirable to perform an unload-reload cycle during the test, with the unloading initiated at a loading increment along the virgin portion of the consolidation curve. The unload-reload cycle provides a more reliable estimate of the recompression characteristics of the soil.</p>

<b>One-Dimensional Consolidation</b>	
AASHTO ASTM	T 216 D 2435
Commentary	<p>When saturated soil masses are subjected to incremental loads, they undergo various degrees of dimensional change. Initially, the incremental load is resisted and carried by the liquid phase of the soil, which develops excess porewater pressures (<math>u</math>) in the soil voids. Depending on the permeability and the availability of drainage layer(s) in contact with the soil, the liquids in the voids begin draining and continue to do so until the <math>u</math> is dissipated. As the hydrostatic pressure decreases, a proportional amount of the incremental load is transferred to the solid portion of the soil. When the excess hydrostatic pressure reaches zero, all of the new load is carried by the soil's solids. This process is called primary consolidation. In granular, high-permeability soils, this transfer takes place very quickly (since water can drain fast). In clays and low-permeability soils, primary consolidation takes a longer time, which can affect the long-term performance of structures supported by these soils. Time rate is expressed by the coefficient of consolidation (<math>c_v</math>).</p> <p>The one-dimensional consolidation test is most commonly used for the determination of consolidation properties of soils. This test method assumes that dimensional change due to consolidation will take place in the vertical direction. This assumption is generally acceptable for stiff or medium, confined cohesive soils, but it is not true for soft soils or for soils that are not confined (i.e., bridge approaches). The data and the analysis produced from this test have proved to be reasonably reliable.</p> <p>Results of one-dimensional consolidation tests can be presented in a variety of ways, the two most common include: (1) <math>e</math>-<math>\log F_v</math> graphs whereby the compression indices (<math>C_r</math>, <math>C_c</math>, <math>C_s</math>) are determined as the slopes of <math>e</math> vs. <math>\log F_v</math> for the recompression, virgin compression, and swelling lines, respectively; or (2) <math>F_v</math> vs. <math>v</math> graphs where the slope is equal to the constrained modulus (<math>D_r</math>). Most importantly, the consolidation test provides the magnitude of the preconsolidation stress (<math>F_{vmax} = F_p = P_c</math>) of the natural deposit, as shown in Figure 7-16c. The effective preconsolidation represents the recorded past stress history of the soil that may have undergone erosion, desiccation, seismic events, groundwater fluctuations, and other mechanisms of overconsolidation, as discussed further in Chapter 9.</p> <p>In many clays, the primary consolidation is typically followed by secondary compression or long-term creep and represented by the parameter <math>C_\alpha</math>. In thick clay deposits, the magnitude of secondary compression may be substantial. For soils known for their tendency to have significant secondary compression particularly under heavy incremental loads, it may be necessary to predict the long-term effects of secondary compression. In that case, each incremental of the test load is left in place until such time that the time-settlement curve plotted for that load becomes asymptotic to a horizontal line.</p> <p>Heavy organic clays also require longer loading periods. The time-settlement curves produced by heavy organic soils may not clearly show the end of the primary consolidation. In those cases, it may be necessary to monitor the pore pressures of the soil to determine the end of the primary stage. It should be noted that the magnitude of secondary, long term, compression of highly (20% or more) organic soils may be as large or larger than the primary consolidation. Secondary compression in these soils takes place as a result of the continuing compression of organic fibers. The substantial dissipation of the excess hydrostatic pressures during the test does not signal the end of significant compression; expulsion of absorbed water with associated compression from the body of the fiber itself may continue for a long period of time.</p>



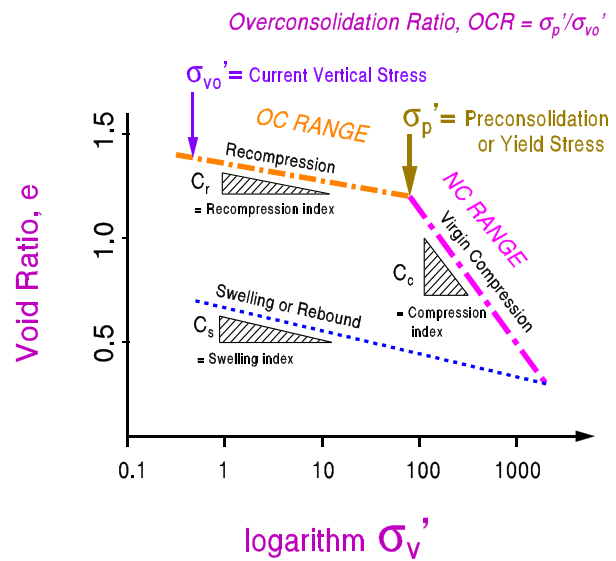
(a)



(b)



(c)



(d)

**Figure 7-16. One Dimensional Consolidation Devices and Results:**  
 (a) Wykeham Farrance oedometer with moment loading arm; (b) Pneumatic consolidometers (Anteus); (c) Rowe cell using hydraulic loading system (GeoComp Corp); and (d) Idealized graphs of  $e$ - $\log F_v r$  for obtaining parameters.



<b>Swell Potential of Clays</b>	
AASHTO ASTM Test	T 256 D 4546
Purpose	To estimate the swell potential of (expansive) soils
Procedure	The swell test is typically performed in a consolidation apparatus. The swell potential is determined by observing the swell of a laterally-confined specimen when it is surcharged and flooded. Alternatively, after the specimen is inundated, the height of the specimen is kept constant by adding loads. The vertical stress necessary to maintain zero volume change is the swelling pressure.
Commentary	<p>Swelling is a characteristic reaction of some clays to saturation. The potential for swell depends on the mineralogical composition. While montmorillonite (smectite) exhibits a high degree of swell potential, illite has none to moderate swell characteristics, and kaolinite exhibits almost none. The percentage of volumetric swell of a soil depends on the amount of clay, its relative density, the compaction moisture and density, permeability, location of the water table, presence of vegetation and trees, and overburden stress. Swelling of foundation, embankment, or pavement soils result in serious and costly damage to structures above them. It is therefore important to estimate the swell potential of these soils. The one dimensional swell potential test is used to estimate the percent swell and swelling pressures developed by the swelling soils.</p> <p>This test can be performed on undisturbed, remolded, or compacted specimens. If the soil structure is not confined (i.e. bridge abutment) such that swelling may occur laterally and vertically, triaxial tests can be used to determine three dimensional swell characteristics.</p>

<b>Collapse Potential of Soils</b>	
AASHTO ASTM	- D 5333
Purpose	To estimate the collapse potential of soils
Procedure	The collapse potential of suspected soils is determined by placing an undisturbed, compacted or remolded specimen in the consolidometer ring and in a loading device at their natural moisture content. A load is applied and the soil is saturated to measure the magnitude of the vertical displacement.
Commentary	<p>Loess or loess type soils is predominantly composed of silts, and contain 3% to 5% clay. Loess deposits are wind blown formations. Loess type deposits have similar composition and they are formed as a result of the removal of organics by decomposition or the leaching of certain minerals (calcium carbonate). In both cases disturbed samples obtained from these deposits will be classified as silt. When dry or at low moisture content the in situ material gives the appearance of a stable silt deposit. At high moisture contents these soils collapse and undergo sudden changes in volume. Loess, unlike other non-cohesive soils, will stand on almost a vertical slope until saturated. It has a low relative density, a low unit weight and a high void ratio. Structures founded on such soils, upon saturation, may be seriously damaged from the collapse of the foundation soils.</p> <p>The collapse during wetting occurs due to the destruction of clay binding which provide the original strength of these soils. It is conceivable that remolding and compacting may also destroy the original structure.</p>

## **7.2 QUALITY ASSURANCE FOR LABORATORY TESTING**

The ability to maintain the quality of samples is largely dependent on the quality assurance program followed by the field and laboratory staff. Significant changes in the material properties may take place as a result of improper storage, transportation and handling of samples resulting in misleading test, and therefore design, results.

### **7.2.1 Storage**

Undisturbed soil samples should be transported and stored such that their structure and their moisture content are maintained as close to their natural conditions as practicable (AASHTO T 207, ASTM D 4220 and D 5079). Specimens stored in special containers should not be placed, even temporarily, in direct sunlight. Undisturbed soil samples should be stored in an upright position with the top side up.

Long term storage of soil samples should be in temperature-controlled environments. The temperature control requirements may vary from subfreezing to ambient and above, depending on the environment of the parent formation. The relative humidity for soil storage normally should be maintained at 90 percent or higher.

Storage of soil samples long term in sampling tubes is not recommended. During long term storage, the sample tubes may experience corrosion. This accompanied by the adhesion of the soil to the tube may develop such resistance to extrusion that some soils may experience internal failures during the extrusion. Often these failures can not be seen by the naked eye; only x-ray radiography (ASTM D 4452) will reveal the presence of such conditions. If these samples are tested as undisturbed specimens the results may be misleading.

Long term storage of samples, even under the best conditions, may cause changes in the characteristics of the of samples. Research has shown that soil samples stored more than fifteen or more days undergo substantial changes in strength characteristics. Soil samples stored for long periods of time provide poor quality specimens, and often unreliable results. Stress relaxation, temperature changes and prolonged exposure to the environment in these cases may have serious impacts on the sample characteristics.

### **7.2.2 Sample Handling**

Careless handling of undisturbed soil samples may cause major disturbances with serious design and construction consequences. Samples should always be handled by experienced personnel in a manner that, during preparation, the sample maintains its structural integrity and its moisture condition. Saws and knives used to trim soils should be clean and sharp. Preparation time should be kept to a minimum, especially where the maintenance of the moisture content is critical. During preparation, specimens should not be exposed to direct sun or precipitation. If samples are dropped, in or out of containers, it is reasonable to expect that they will be disturbed. They should not be used for critical tests (i.e. elastic moduli, triaxial) requiring undisturbed specimens.

### **7.2.3 Specimen Selection**

The selection of representative specimens for testing is one of the most important aspects of sampling and testing procedures. Selected specimens must be representative of the formation being investigated. Seldom one finds a uniform homogeneous deposit or formation.

The senior laboratory technician, the geologist and/or the geotechnical engineer need to study the drilling logs, understand the geology of the site, and visually examine the samples before selecting the test specimens. Samples should be selected on the basis of their color, physical appearance, and structural features. Specimens should be selected to represent all types of materials present at the site, not just the worst or the best. Samples with discontinuities and intrusions may cause premature failures in the laboratory. They, however, would not cause such failures in situ. Such failures should be noted but not selected as representative of the deposit of the formation.

There is no single set of rules that can be applied to all specimen selection. In selecting the proper specimens, the geotechnical engineer, the geologist, and senior laboratory technician must apply their knowledge and experience with the geologic setting, materials, and project requirements.

#### **7.2.4 Equipment Calibration**

All laboratory equipment should be periodically checked to verify that they meet the tolerances as established by the AASHTO and ASTM test procedures. Sieves, ovens, compaction molds, triaxial and permeability cells should be periodically examined to assure that they meet the opening size, temperature and volumetric tolerances. Compression or tension testing equipment, including proving rings and transducers should be checked quarterly and calibrated at least once a year using U.S. Bureau of Standards certified equipment. Scales, particularly electronic or reflecting mirror types, should be checked at least once every day to assure that they are leveled and in proper adjustment. Electronic equipment and software should also be checked periodically (i.e. quarterly) to assure that all is well.

#### **7.2.5 Pitfalls**

Sampling and testing of soils are the most important and fundamental steps in the design and construction of all types of structures. Omissions or errors introduced in these steps, if gone undetected, will be carried through the process of design and construction resulting often in costly or possibly unsafe facilities. Table 7-4 lists topics that should be considered for proper handling of samples, preparation, and laboratory test procedures. Table 7-4 should in no way be construed as being a complete list of possible important items in the handling or testing of soil specimens; there are many more. These are just some of the more common ones.

TABLE 7-4.

COMMON SENSE GUIDELINES FOR LABORATORY TESTING OF SOILS

- 
- 
1. Protect samples to prevent moisture loss and structural disturbance.
  2. Carefully handle samples during extrusion of samples; samples must be extruded properly and supported upon their exit from the tube.
  3. Avoid long term storage of soil samples in Shelby tubes.
  4. Properly number and identify samples.
  5. Store samples in properly controlled environments.
  6. Visually examine and identify soil samples after removal of smear from the sample surface.
  7. Use pocket penetrometer or miniature vane only for an indication of strength.
  8. Carefully select "representative" specimens for testing.
  9. Have a sufficient number of samples to select from.
  10. Always consult the field logs for proper selection of specimens.
  11. Recognize disturbances caused by sampling, the presence of cuttings, drilling mud or other foreign matter and avoid during selection of specimens.
  12. Do not depend solely on the visual identification of soils for classification.
  13. Always perform organic content tests when classifying soils as peat or organic. Visual classifications of organic soils may be very misleading.
  14. Do not dry soils in overheated or underheated ovens.
  15. Discard old worn-out equipment; old screens for example, particularly fine (<No. 40) mesh ones need to be inspected and replaced often, worn compaction mold or compaction hammers (an error in the volume of a compaction mold is amplified 30x when translated to unit volume) should be checked and replaced if needed.
  16. Performance of Atterberg Limits requires carefully adjusted drop height of the Liquid Limit machine and proper rolling of Plastic Limit specimens.
  17. Do not use of tap water for tests where distilled water is specified.
  18. Properly cure stabilization test specimens.
  19. Never assume that all samples are saturated as received.
  20. Saturation must be performed using properly staged back pressures.
  21. Use properly fitted o-rings, membranes etc. in triaxial or permeability tests.
  22. Evenly trim the ends and sides of undisturbed samples.
  23. Be careful to identify slickensides and natural fissures. Report slickensides and natural fissures.
  24. Also do not mistakenly identify failures due to slickensides as shear failures.
  25. Do not use unconfined compression test results (stress-strain curves) to determine elastic moduli.
  26. Incremental loading of consolidation tests should only be performed after the completion of each primary stage.
  27. Use proper loading rate for strength tests.
  28. Do not guesstimate e-log p curves from accelerated, incomplete consolidation tests.
  29. Avoid "Reconstructing" soil specimens, disturbed by sampling or handling, for undisturbed testing.
  30. Correctly label laboratory test specimens.
  31. Do not take shortcuts: using non-standard equipment or non-standard test procedures.
  32. Periodically calibrate all testing equipment and maintain calibration records.
  33. Always test a sufficient number of samples to obtain representative results in variable material.
- 
-

### 7.3 SELECTION AND ASSIGNMENT OF TESTS

Certain considerations regarding laboratory testing, such as when, how much, and what type, can only be decided by an experienced geotechnical engineer. The following minimal criteria should be considered while determining the scope of the laboratory testing program:

- C Project type (bridge, embankment, rehabilitation, buildings, etc.)
- C Size of the project
- C Loads to be imposed on the foundation soils
- C Types of loads (i.e., static, dynamic, etc.)
- C Critical tolerances for the project (e.g., settlement limitations)
- C Vertical and horizontal variations in the soil profile as determined from boring logs and visual identification of soil types in the laboratory
- C Known or suspected peculiarities of soils at the project location (i.e., swelling soils, collapsible soils, organics, etc.)
- C Presence of visually observed intrusions, slickensides, fissures, concretions, etc.

The selection of tests should be considered preliminary until the geotechnical engineer is satisfied that the test results are sufficient to develop reliable soil profiles and provide the soil parameters needed for design. Laboratory visual identification of all soil samples extracted from the borings should be performed. The soil groups with similar engineering properties should be classified using the Unified Soil Classification System (ASTM D2487) [preferred for geotechnical practice] or the AASHTO system (M145) with classification tests performed on selected samples as requested by the engineer. Moisture content analysis should be performed on all cohesive samples and, if possible, on all samples. The geotechnical engineer should then determine the appropriate tests required to obtain the design parameters or validate design parameters obtained from field tests for each soil layer. A summary of information needs and testing considerations for a range of applications is provided in Table 7-5 (from GEC 5). Additional guidance on the selection of soil and rock properties is contained in the FHWA “Soil and Foundations Workshop” reference manual.

**Table 7-5. Summary of information needs and testing considerations for a range of highway applications.**  
 (from FHWA Geotechnical Engineering Circular 5 – Soil and Rock Properties, 2002)

Geotechnical Issues	Engineering Evaluations	Required Information for Analyses	Field Testing	Laboratory Testing
<b>Shallow Foundations</b>	<ul style="list-style-type: none"> <li>● bearing capacity</li> <li>● settlement (magnitude &amp; rate)</li> <li>● shrink/swell of foundation soils (natural soils or embankment fill)</li> <li>● chemical compatibility of soil and concrete</li> <li>● frost heave</li> <li>● scour (for water crossings)</li> <li>● extreme loading</li> </ul>	<ul style="list-style-type: none"> <li>● subsurface profile (soil, groundwater, rock)</li> <li>● shear strength parameters</li> <li>● compressibility parameters (including consolidation, shrink/swell potential, and elastic modulus)</li> <li>● frost depth</li> <li>● stress history (present and past vertical effective stresses)</li> <li>● chemical composition of soil</li> <li>● depth of seasonal moisture change</li> <li>● unit weights</li> <li>● geologic mapping including orientation and characteristics of rock discontinuities</li> </ul>	<ul style="list-style-type: none"> <li>● vane shear test</li> <li>● SPT (granular soils)</li> <li>● CPT</li> <li>● dilatometer</li> <li>● rock coring (RQD)</li> <li>● nuclear density</li> <li>● plate load testing</li> <li>● geophysical testing</li> </ul>	<ul style="list-style-type: none"> <li>● 1-D oedometer tests</li> <li>● direct shear tests</li> <li>● triaxial tests</li> <li>● grain size distribution</li> <li>● Atterberg Limits</li> <li>● pH, resistivity tests</li> <li>● moisture content</li> <li>● unit weight</li> <li>● organic content</li> <li>● collapse/swell potential tests</li> <li>● rock uniaxial compression test and intact rock modulus</li> <li>● point load strength test</li> </ul>
<b>Driven Pile Foundations</b>	<ul style="list-style-type: none"> <li>● pile end-bearing</li> <li>● pile skin friction</li> <li>● settlement</li> <li>● down-drag on pile</li> <li>● lateral earth pressures</li> <li>● chemical compatibility of soil and pile</li> <li>● driveability</li> <li>● presence of boulders/ very hard layers</li> <li>● scour (for water crossings)</li> <li>● vibration/heave damage to nearby structures</li> <li>● extreme loading</li> </ul>	<ul style="list-style-type: none"> <li>● subsurface profile (soil, ground water, rock)</li> <li>● shear strength parameters</li> <li>● horizontal earth pressure coefficients</li> <li>● interface friction parameters (soil and pile)</li> <li>● compressibility parameters</li> <li>● chemical composition of soil/rock</li> <li>● unit weights</li> <li>● presence of shrink/swell soils (limits skin friction)</li> <li>● geologic mapping including orientation and characteristics of rock discontinuities</li> </ul>	<ul style="list-style-type: none"> <li>● SPT (granular soils)</li> <li>● pile load test</li> <li>● CPT</li> <li>● vane shear test</li> <li>● dilatometer</li> <li>● piezometers</li> <li>● rock coring (RQD)</li> <li>● geophysical testing</li> </ul>	<ul style="list-style-type: none"> <li>● triaxial tests</li> <li>● interface friction tests</li> <li>● grain size distribution</li> <li>● 1-D oedometer tests</li> <li>● pH, resistivity tests</li> <li>● Atterberg Limits</li> <li>● organic content</li> <li>● moisture content</li> <li>● unit weight</li> <li>● collapse/swell potential tests</li> <li>● slake durability</li> <li>● rock uniaxial compression test and intact rock modulus</li> <li>● point load strength test</li> </ul>

Table 7-5. Summary of information needs and testing considerations for a range of highway applications (continued).

Geotechnical Issues	Engineering Evaluations	Required Information for Analyses	Field Testing	Laboratory Testing
<b>Drilled Shaft Foundations</b>	<ul style="list-style-type: none"> <li>● shaft end bearing</li> <li>● shaft skin friction</li> <li>● constructability</li> <li>● down-drag on shaft</li> <li>● quality of rock socket</li> <li>● lateral earth pressures</li> <li>● settlement (magnitude &amp; rate)</li> <li>● groundwater seepage/dewatering</li> <li>● presence of boulders/ very hard layers</li> <li>● scour (for water crossings)</li> <li>● extreme loading</li> </ul>	<ul style="list-style-type: none"> <li>● subsurface profile (soil, ground water, rock)</li> <li>● shear strength parameters</li> <li>● interface shear strength friction parameters (soil and shaft)</li> <li>● compressibility parameters</li> <li>● horizontal earth pressure coefficients</li> <li>● chemical composition of soil/rock</li> <li>● unit weights</li> <li>● permeability of water-bearing soils</li> <li>● presence of artesian conditions</li> <li>● presence of shrink/swell soils (limits skin friction)</li> <li>● geologic mapping including orientation and characteristics of rock discontinuities</li> <li>● degradation of soft rock in presence of water and/or air (e.g., rock sockets in shales)</li> </ul>	<ul style="list-style-type: none"> <li>● technique shaft</li> <li>● shaft load test</li> <li>● vane shear test</li> <li>● CPT</li> <li>● SPT (granular soils)</li> <li>● dilatometer</li> <li>● piezometers</li> <li>● rock coring (RQD)</li> <li>● geophysical testing</li> </ul>	<ul style="list-style-type: none"> <li>● 1-D oedometer</li> <li>● triaxial tests</li> <li>● grain size distribution</li> <li>● interface friction tests</li> <li>● pH, resistivity tests</li> <li>● permeability tests</li> <li>● Atterberg Limits</li> <li>● moisture content</li> <li>● unit weight</li> <li>● organic content</li> <li>● collapse/swell potential tests</li> <li>● rock uniaxial compression test and intact rock modulus</li> <li>● point load strength test</li> <li>● slake durability</li> </ul>
<b>Embankments and Embankment Foundations</b>	<ul style="list-style-type: none"> <li>● settlement (magnitude &amp; rate)</li> <li>● bearing capacity</li> <li>● slope stability</li> <li>● lateral pressure</li> <li>● internal stability</li> <li>● borrow source evaluation (available quantity and quality of borrow soil)</li> <li>● required reinforcement</li> </ul>	<ul style="list-style-type: none"> <li>● subsurface profile (soil, ground water, rock)</li> <li>● compressibility parameters</li> <li>● shear strength parameters</li> <li>● unit weights</li> <li>● time-rate consolidation parameters</li> <li>● horizontal earth pressure coefficients</li> <li>● interface friction parameters</li> <li>● pullout resistance</li> <li>● geologic mapping including orientation and characteristics of rock discontinuities</li> <li>● shrink/swell/degradation of soil and rock fill</li> </ul>	<ul style="list-style-type: none"> <li>● nuclear density</li> <li>● plate load test</li> <li>● test fill</li> <li>● CPT</li> <li>● SPT (granular soils)</li> <li>● dilatometer</li> <li>● vane shear</li> <li>● rock coring (RQD)</li> <li>● geophysical testing</li> </ul>	<ul style="list-style-type: none"> <li>● 1-D Oedometer</li> <li>● triaxial tests</li> <li>● direct shear tests</li> <li>● grain size distribution</li> <li>● Atterberg Limits</li> <li>● organic content</li> <li>● moisture-density relationship</li> <li>● hydraulic conductivity</li> <li>● geosynthetic/soil testing</li> <li>● shrink/swell</li> <li>● slake durability</li> <li>● unit weight</li> </ul>

Table 7-5. Summary of information needs and testing considerations for a range of highway applications (continued).

Geotechnical Issues	Engineering Evaluations	Required Information for Analyses	Field Testing	Laboratory Testing
<b>Excavations and Cut Slopes</b>	<ul style="list-style-type: none"> <li>● slope stability</li> <li>● bottom heave</li> <li>● liquefaction</li> <li>● dewatering</li> <li>● lateral pressure</li> <li>● soil softening/progressive failure</li> <li>● pore pressures</li> </ul>	<ul style="list-style-type: none"> <li>● subsurface profile (soil, ground water, rock)</li> <li>● shrink/swell properties</li> <li>● unit weights</li> <li>● hydraulic conductivity</li> <li>● time-rate consolidation parameters</li> <li>● shear strength of soil and rock (including discontinuities)</li> <li>● geologic mapping including orientation and characteristics of rock discontinuities</li> </ul>	<ul style="list-style-type: none"> <li>● test cut to evaluate stand-up time</li> <li>● piezometers</li> <li>● CPT</li> <li>● SPT (granular soils)</li> <li>● vane shear</li> <li>● dilatometer</li> <li>● rock coring (RQD)</li> <li>● in situ rock direct shear test</li> <li>● geophysical testing</li> </ul>	<ul style="list-style-type: none"> <li>● hydraulic conductivity</li> <li>● grain size distribution</li> <li>● Atterberg Limits</li> <li>● triaxial tests</li> <li>● direct shear tests</li> <li>● moisture content</li> <li>● slake durability</li> <li>● rock uniaxial compression test &amp; intact rock modulus</li> <li>● point load strength test</li> </ul>
<b>Fill Walls/ Reinforced Soil Slopes</b>	<ul style="list-style-type: none"> <li>● internal stability</li> <li>● external stability</li> <li>● settlement</li> <li>● horizontal deformation</li> <li>● lateral earth pressures</li> <li>● bearing capacity</li> <li>● chemical compatibility with soil and wall materials</li> <li>● pore pressures behind wall</li> <li>● borrow source evaluation (available quantity and quality of borrow soil)</li> </ul>	<ul style="list-style-type: none"> <li>● subsurface profile (soil, ground water, rock)</li> <li>● horizontal earth pressure coefficients</li> <li>● interface shear strengths</li> <li>● foundation soil/wall fill shear strengths</li> <li>● compressibility parameters (including consolidation, shrink/swell potential, and elastic modulus)</li> <li>● chemical composition of fill/ foundation soils</li> <li>● hydraulic conductivity of soils behind wall</li> <li>● time-rate consolidation parameters</li> <li>● geologic mapping including orientation and characteristics of rock discontinuities</li> </ul>	<ul style="list-style-type: none"> <li>● SPT (granular soils)</li> <li>● CPT</li> <li>● dilatometer</li> <li>● vane shear</li> <li>● piezometers</li> <li>● test fill</li> <li>● nuclear density</li> <li>● pullout test (MSEW/RSS)</li> <li>● rock coring (RQD)</li> <li>● geophysical testing</li> </ul>	<ul style="list-style-type: none"> <li>● 1-D Oedometer</li> <li>● triaxial tests</li> <li>● direct shear tests</li> <li>● grain size distribution</li> <li>● Atterberg Limits</li> <li>● pH, resistivity tests</li> <li>● moisture content</li> <li>● organic content</li> <li>● moisture-density relationships</li> <li>● hydraulic conductivity</li> </ul>
<b>Cut Walls</b>	<ul style="list-style-type: none"> <li>● internal stability</li> <li>● external stability</li> <li>● excavation stability</li> <li>● dewatering</li> <li>● chemical compatibility of wall/soil</li> <li>● lateral earth pressure</li> <li>● down-drag on wall</li> <li>● pore pressures behind wall</li> <li>● obstructions in retained soil</li> </ul>	<ul style="list-style-type: none"> <li>● subsurface profile (soil, ground water, rock)</li> <li>● shear strength of soil</li> <li>● horizontal earth pressure coefficients</li> <li>● interface shear strength (soil and reinforcement)</li> <li>● hydraulic conductivity of soil</li> <li>● geologic mapping including orientation and characteristics of rock discontinuities</li> </ul>	<ul style="list-style-type: none"> <li>● test cut to evaluate stand-up time</li> <li>● well pumping tests</li> <li>● piezometers</li> <li>● SPT (granular soils)</li> <li>● CPT</li> <li>● vane shear</li> <li>● dilatometer</li> <li>● pullout tests (anchors, nails)</li> <li>● geophysical testing</li> </ul>	<ul style="list-style-type: none"> <li>● triaxial tests</li> <li>● direct shear</li> <li>● grain size distribution</li> <li>● Atterberg Limits</li> <li>● pH, resistivity tests</li> <li>● organic content</li> <li>● hydraulic conductivity</li> <li>● moisture content</li> <li>● unit weight</li> </ul>



## CHAPTER 8.0

### LABORATORY TESTING FOR ROCKS

#### 8.1 INTRODUCTION

Laboratory rock testing is performed to determine the strength and elastic properties of intact specimens and the potential for degradation and disintegration of the rock material. The derived parameters are used in part for the design of rock fills, cut slopes, shallow and deep foundations, tunnels, and the assessment of shore protection materials (rip-rap). Deformation and strength properties of intact specimens aid in evaluating the larger-scale rock mass that is significantly controlled by joints, fissures, and discontinuity features (spacing, roughness, orientation, infilling), water pressures, and ambient geostatic stress state.

#### 8.2 LABORATORY TESTS

Common laboratory tests for intact rocks include measurements of strength (point load index, compressive strength, Brazilian test, direct shear), stiffness (ultrasonics, elastic modulus), and durability (slaking, abrasion). Table 8-1 gives a summary list of laboratory rock tests and procedures by ASTM. Brief sections discuss the common tests (denoted with an asterisk\*) useful for a standard highway project involving construction in rock.

##### 8.2.1 Strength Tests

The laboratory determination of intact rock strength is accomplished by the following tests: point load index, unconfined compression, triaxial compression, Brazilian test, and direct shear. The uniaxial (or unconfined) compression test provides the general reference value, having a respective analogy with standard tests on concrete cylinders. The uniaxial compressive strength ( $q_u = F_u$ ) is obtained by compressing a trimmed cylindrical specimen in the longitudinal direction and taking the maximum measured force divided by the cross-sectional area. The point load index serves as a surrogate for the UCS and is a simpler test in that irregular pieces of rock core can be used. A direct tensile test requires special end preparation that is difficult for most commercial labs, therefore tensile strength is more often evaluated by compression loading of cylindrical specimens across their diameter (known as the Brazilian test). Direct shear tests are used to investigate frictional characteristics along rock discontinuity features.



**Figure 8-1: (a) Intact Rock Specimens for Laboratory Testing; (b) Compressive Strength Testing.**

TABLE 8-1.

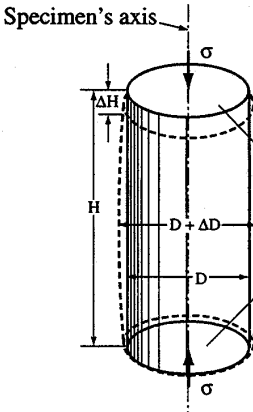
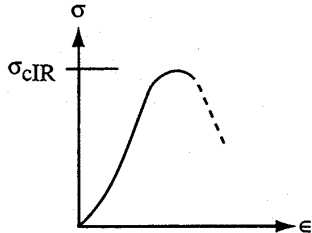
STANDARDS & PROCEDURES FOR LABORATORY TESTING OF INTACT ROCK

<i>Test Category</i>	<i>Name of Test</i>	<i>Test Designation</i>	
		<i>AASHTO</i>	<i>ASTM</i>
Point Load Strength	Method for determining point load index ( $I_s$ )	-	D 5731*
Compressive Strength	Compressive strength ( $q_u = F_u$ ) of core in unconfined compression (uniaxial compression test)	-	D 2938*
	Triaxial compressive strength without pore pressure	T 226	D 2664
Creep Tests	Creep-cylindrical hard rock core in uniaxial compression	-	D 4341
	Creep-cylindrical soft rock core in uniaxial compression	-	D 4405
	Creep-cylindrical hard rock core, in triaxial compression	-	D 4406
Tensile Strength	Direct tensile strength of intact rock core specimens	-	D 3936
	Splitting tensile strength of intact core (Brazilian test)	-	D 3967*
Direct Shear	Laboratory direct shear strength tests - rock specimens, under constant normal stress	-	D 5607*
Permeability	Permeability of rocks by flowing air	-	D 4525
Durability	Slake durability of shales and similar weak rocks	-	D 4644*
	Rock slab testing for riprap soundness, using sodium/magnesium sulfate	-	D 5240*
	Rock-durability for erosion control under freezing/thawing	-	D 5312*
	Rock-durability for erosion control under wetting/drying	-	D 5313
Deformation and Stiffness	Elastic moduli of intact rock core in uniaxial compression	-	D 3148*
	Elastic moduli of intact rock core in triaxial compression	-	D 5407
	Pulse velocities and ultrasonic elastic constants in rock	-	D 2845*
Specimen Preparation	Rock core specimen preparation	-	D 4543
	Rock slab preparation for durability testing	-	D 5121

*Note:* \*Routine rock test procedure described in this manual

<b>Point Load Index (Strength)</b>	
ASTM	D 5731
Purpose	To determine strength classification of rock materials through an index test.
Procedure	<p>Rock specimens in the form of core (diametral and axial), cut blocks or irregular lumps are broken by application of concentrated load through a pair of spherically truncated, conical platens. The distance between specimen-platen contact points is recorded. The load is steadily increased, and the failure load is recorded.</p> <p>There is little sample preparation. However, specimens should conform to the size and shape requirements as specified by ASTM. In general, for the diametral test, core specimens with a length-to-diameter ratio of 1.0 are adequate while for the axial test core specimens with length-to-diameter ratio of 0.3 to 1.0 are suitable. Specimens for the block and the irregular lump test should have a length of <math>50 \pm 35</math> mm and a depth/width ratio between 0.3 and 1.0 (preferably close to 1.0). The test specimens are typically tested at their natural water content.</p> <p>Size corrections are applied to obtain the point load strength index, <math>I_{s(50)}</math>, of a rock specimen. A strength anisotropy index, <math>I_{a(50)}</math>, is determined when <math>I_{s(50)}</math> values are measured perpendicular and parallel to planes of weakness.</p>
Commentary	<p>The test can be performed in the field with portable equipment or in the laboratory (Figure 8-1). The point load index is used to evaluate the uniaxial compressive strength (<math>F_u</math>). On the average, <math>F_u \approx 25 I_{s(50)}</math>. However, the coefficient term can vary from 15 to 50 depending upon the specific rock formation, especially for anisotropic rocks. The test should not be used for weak rocks where <math>F_u &lt; 25</math> MPa.</p> <div style="text-align: center;"> <p>The diagram illustrates the Point Load Test Apparatus. It features a vertical cylindrical assembly. At the bottom is a hydraulic jack. Above it is a loading frame. A graduated scale is positioned around the central shaft. A rock core is held between two conical ends. A follower needle is attached to the top of the rock core. A pressure gage is connected to the top of the assembly via a flexible hydraulic hose.</p> </div>

**Figure 8-1: Point Load Test Apparatus.** (Adopted from Roctest)

<b>Uniaxial Compression Test</b>	
AASHTO ASTM	- D 2938
Purpose	To determine the uniaxial compressive strength of rock ( $q_u = F_u = F_C$ ).
Procedure	<p>In this test, cylindrical rock specimens are tested in compression without lateral confinement. The test procedure is similar to the unconfined compression test for soils and concrete. The test specimen should be a rock cylinder of length-to-width ratio (H/D) in the range of 2 to 2.5 with flat, smooth, and parallel ends cut perpendicular to the cylinder axis. Originally, specimen diameters of NX size were used (<math>D = 2\frac{1}{8}</math> in. = 44 mm), yet now the standard size is NQ core (<math>D = 1\frac{7}{8}</math> in. = 47.6 mm).</p> <div style="text-align: center;">  </div> <div style="margin-left: 550px; border: 1px solid black; padding: 5px; width: fit-content;"> <p>State of stress in the middle part of the sample:  <math>\sigma_1 = \sigma</math> , <math>\sigma_2 = \sigma_3 = 0</math></p> </div> <div style="margin-left: 550px; border: 1px solid black; padding: 5px; width: fit-content;"> <p>Specimen strains:  <math>\epsilon_{axial} = -\frac{\Delta H}{H}</math>    <math>\epsilon_{radial} = -\frac{\Delta D}{D}</math></p> </div> <div style="margin-left: 200px; margin-top: 20px;"> <p>(b)</p>  </div> <p><b>Figure 8-2: Uniaxial Compression Test on Rock with (a) Definitions of stress conditions and strains, (b) Derived stress-strain curve with peak stress corresponding to the uniaxial compressive strength (<math>q_u = F_u</math>)</b></p>
Commentary	<p>The uniaxial compression test is most direct means of determining rock strength. The results are influenced by the moisture content of the specimens, and thus should be noted. The rate of loading and the condition of the two ends of the rock will also affect the final results. Ends should be planar and parallel per ASTM D 4543. The rate of loading should be constant as per the ASTM test procedure. Inclined fissures, intrusions, and other anomalies will often cause premature failures on those planes. These should be noted so that, where appropriate, other tests such as triaxial or direct shear tests can be required.</p>

<b>Splitting Tensile (Brazilian) Test for Intact Rocks</b>	
AASHTO ASTM	None D 3967
Purpose	To evaluate the (indirect) tensile shear of intact rock core, $F_T$ .
Procedures	<p>Core specimens with length-to-diameter ratios (L/D) of between 2 to 2.5 are placed in a compression loading machine with the load platens situated diametrically across the specimen. The maximum load (P) to fracture the specimen is recorded and used to calculate the split tensile strength.</p> <div style="text-align: center;"> <p style="text-align: center;"><i>Compression Loading Machine</i></p> <p style="text-align: center;"><b>P = maximum measured force</b></p> <p style="text-align: center;"><i>L = specimen length</i></p> <p style="text-align: center;"><b>D = diameter</b></p> <p style="text-align: center;"><b>Splitting (Brazilian) Tensile Strength:</b> <b><math>\sigma_T = 2 P / (\pi LD)</math></b></p> </div> <p><b>Figure 8-3. Setup for Brazilian Tensile Test in Standard Loading Machine.</b></p>
Commentary	<p>The Brazilian or split-tensile strength (<math>F_T</math>) is significantly more convenient and practicable for routine measurements than the direct tensile strength test (<math>T_0</math>). The test gives very similar results to those from direct tension (Jaeger &amp; Cook, 1976). It is a more fundamental strength measurement of the rock material, as this corresponds to a more likely failure mode in many situations than compression. Also, note that the point load index is actually a type of Brazilian tensile strength, that is correlated back to compressive strength. Additional details on tensile strengths of rocks is given in Chapter 10.</p>

### Direct Shear Strength of Rock

AASHTO  
ASTM

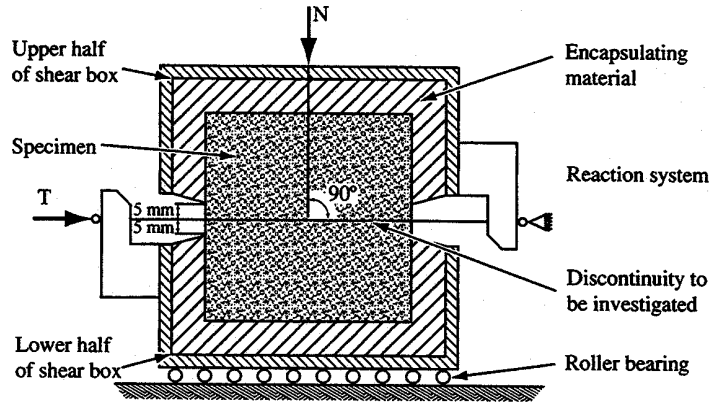
-  
D 5607

Purpose

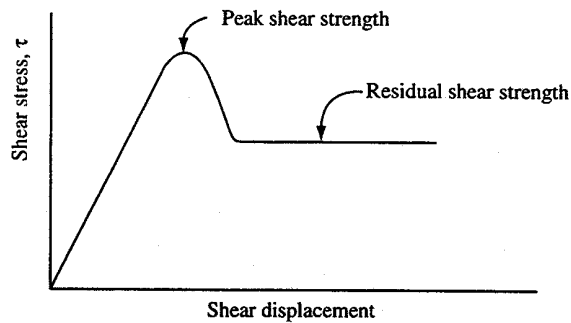
To determine the shear strength characteristics of rock along a plane of weakness.

Procedure

The laboratory test equipment is shown below in Figure 8-4. The specimen is placed in the lower half of the shear box and encapsulated in either synthetic resin or mortar. The specimen must be positioned so that the line of action of the shear force lies in the plane of the discontinuity to be investigated, and the normal force acts perpendicular to this surface. Once the encapsulating material has hardened, the specimen is mounted in the upper half of the shear box in the same manner. A strip approximately 5 mm wide above and below the shear surface must be kept free of encapsulating material. The test is then carried out by applying a horizontal shear force  $T$  under a constant normal load,  $N$ .



(a)



(b)

**Figure 8-4: (a) General Set-up for Direct Shear Strength Testing of Rock (Wittke, 1990) (b) Derived Shear Stress vs. Shear Displacement Curve. (ASTM D 5607, 1995)**

(Direct Shear Testing of Rock - Continued)	
Commentary	<p>Determination of shear strength of rock specimens is an important aspect in the design of structures such as rock slopes, foundations and other purposes. Pervasive discontinuities (joints, bedding planes, shear zones, fault zones, schistosity) in a rock mass, and genesis, crystallography, texture, fabric, and other factors can cause the rock mass to behave as an anisotropic and heterogeneous discontinuum. Therefore, the precise prediction of rock mass behavior is difficult.</p> <p>For nonplanar joints or discontinuities, shear strength is derived from a combination base material friction and overriding of asperities (dilatancy), shearing or breaking of the asperities, rotations at or wedging of the asperities (Patton, 1966). Sliding on and shearing of the asperities can occur simultaneously. When the normal force is not sufficient to restrain dilation, the shear mechanism consists of the overriding of the asperities. When the normal load is large enough to completely restrain dilation, the shear mechanism consists of the shearing off of the asperities.</p> <p>Using this test method to determine the shear strength of intact rock may generate overturning moments that induce premature tensile breaking. Thus, the specimen would fail in tension first rather than in shear.</p> <p>Rock shear strength is influenced by the overburden stresses; therefore, the larger the overburden stress, the larger the shear strength.</p> <p>In some cases, it may be desirable to conduct tests in-situ rather than in the laboratory to more accurately determine a representative shear strength of the rock mass, particularly when design is controlled by discontinuities filled with very weak material.</p>

### 8.2.2 Durability

The evaluation of rock durability becomes an issue when the materials are to be subjected to the natural elements, seasonal weather, and repeated cycles of temperature (e.g., flowing water, wetting and drying, wave action, freeze and thaw, etc.) in its proposed use. Tests to measure durability depend on the type of rock, on its use in construction, and on the elements to which the rock will be subjected. The basis for durability tests are empirical and the results produced are an indication of the rock's resistance to natural processes; the rock's behavior in actual use may vary greatly from the test results. These tests, however, provide reasonably reliable tools for quality control. The suitability of various types of rock for different uses should, in addition to these test results, depend on their performance in previous applications. An example of the use of rock durability tests is in the evaluation of shale in rock fill embankments.

<b>Slake Durability</b>	
AASHTO ASTM	- D 4644 (for shales and similar weak rocks)
Purpose	To determine the durability of shale or other weak or soft rocks subjected to cycles of wetting and drying.
Procedure	<p>In this test dried fragments of rock of known weight are placed in a drum fabricated with 2.0 mm square mesh wire cloth. Figure 8-4 shows a schematic of the test apparatus. The drum is rotated in a horizontal position along its longitudinal axis while partially submerged in distilled water to promote wetting of the sample. The specimens and the drum are dried at the end of the rotation cycle (10 minutes at 20 rpm) and weighed. After two cycles of rotating and drying the weight loss and the shape and size of the remaining rock fragments are recorded and the Slake Durability Index (SDI) is calculated. Both the SDI and the description of the shape and size of the remaining particles are used to determine the durability of soft rocks.</p> <div style="text-align: center;"> </div> <p><b>Figure 8-5: Rotating Drum Assembly and Setup of Slake Durability Equipment.</b> (ASTM D 4644, 1995)</p>
Commentary	This test is typically performed on shales and other weak rocks that may be subject to degradation in the service environment. When some shales are newly exposed to atmospheric conditions, they can degrade rapidly and affect the stability of a rock fill or cut, the subgrade on which a foundation is to be placed, or the base and side walls of drilled shafts prior to placement of concrete.



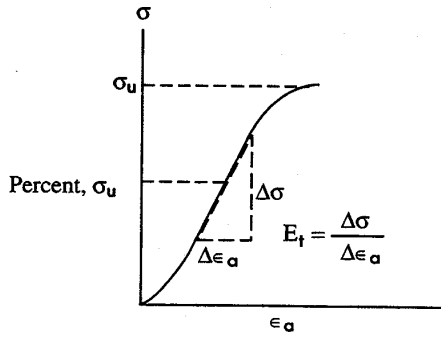
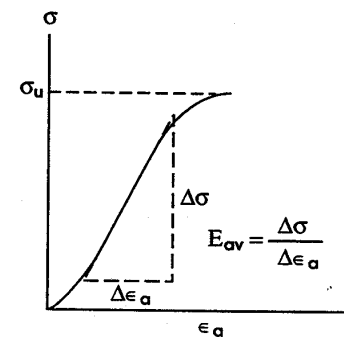
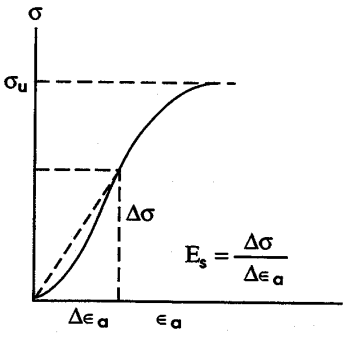
<b>Soundness of Riprap</b>	
AASHTO ASTM	- D 5240
Purpose	To determine the soundness of rock subjected to erosion.
Procedure	The procedure is known as the Rock Slab Soundness Test. Two representative, sawed, rock slab specimens are immersed in a solution of sodium or magnesium sulfate and dried and weighed for five cycles. The percent weight loss as a result of these tests is expressed as percent soundness.
Commentary	One of the most effective means to control erosion along riverbanks and coastal beaches is by covering exposed soil with rip-rap, or a combination of geosynthetics and rip-rap. Rock or stone used in this mode is subject to degradation from weathering effects due to repeated cycles of wetting & drying, as well as repeated exposure to salts used in de-icing of roadways. This test is used to estimate this type of degradation. A similar test for aggregates is available through ASTM C 88.

<b>Durability Under Freezing and Thawing</b>	
AASHTO ASTM	- D 5312
Purpose	To determine the resistance of rock used for erosion control to repeated cycles of freezing and thawing.
Procedure	Slabs of representative rock specimens are subjected to freezing and thawing cycles in the laboratory. The loss of dry weight at the end of five successive cycles of freezing, thawing, and drying is expressed as percent loss due to freeze/thaw.
Commentary	This test is useful in assessing the durability of rock due to weathering effects, in particularly for stone and gravel aggregates used in northern climates where seasonal winters will degrade their use in highway construction. It can also be used to assess the durability of armor stones placed for shore protection or rip-rap placed for shoreline protection or dam embankment protection.

As discussed above, none of these tests provide results which can be used independent of each other or independent of other tests and experience. Often the behavior of rip-rap stone in actual use will vary widely from the laboratory behavior.

### 8.2.3. Deformation Characteristics of Intact Rocks

The stiffness of rocks is represented by an equivalent elastic modulus at small- to intermediate-strains.

<b>Elastic Moduli</b>	
AASHTO ASTM	- D 3148
Purpose	To determine the deformation characteristics of intact rock at intermediate strains and permit comparison with other intact rock types.
Procedure	<p>This test is performed by placing an intact rock specimen in a loading device and recording the deformation of the specimen under axial stress. The Young's modulus, either average, secant, or tangent moduli, can be determined by plotting axial stress versus axial strain curves.</p> <div style="display: flex; justify-content: space-around; align-items: flex-end;"> <div style="text-align: center;">  <p>(a) Tangent Modulus Measured at a Fixed Percentage of Ultimate Strength</p> </div> <div style="text-align: center;">  <p>(b) Average Modulus of Linear Portion of Axial Stress-Strain Curve</p> </div> </div> <div style="text-align: center; margin-top: 20px;">  <p>(c) Secant Modulus Measured up to a Fixed Percentage of Ultimate Strength</p> </div> <p><b>Figure 8-6: Definitions for Determining Elastic (Young's) Modulus from Axial Stress-Strain Measurements During Compression Loading</b>, including (a) Tangent, (b) Average, and (c) Secant Values. (ASTM D 3148)</p>
Commentary	The results of these tests cannot always be replicated because of localized variations in the each unique rock specimen. They provide reasonably reliable data for engineering applications involving rock classification type, but must be adjusted to take into account rock mass characteristics such as jointing, fissuring, and weathering.

<b>Ultrasonic Testing</b>	
AASHTO ASTM	- D 2845
Purpose	To determine the pulse velocities of compression and shear waves in intact rock and the ultrasonic elastic constants of isotropic rock.
Procedure	<p>Ultrasound waves are transmitted through a carefully prepared rock specimen. The ultrasonic elastic constants are calculated from the measured travel time and distance of compression and shear waves in a rock specimen. Figure 8-7 shows a schematic diagram of typical apparatus used for ultrasonic testing.</p> <div style="text-align: center;"> </div> <p>Note: Components shown by dashed lines are optional, depending on method of travel-time measurement and voltage sensitivity of oscilloscope.</p> <p><b>Figure 8-7: Schematic Diagram of the Ultrasonics Apparatus (ASTM D 2845)</b></p>
Commentary	<p>The primary advantages of ultrasonic testing are that it yields compression (P-wave) and shear (S-wave) velocities, and ultrasonic values for the elastic constants of intact homogeneous isotropic rock specimens. Elastic constants for rocks having pronounced anisotropy may require measurements to be taken across different directions to reflect orthorhombic stiffnesses and moduli, particularly if pronounced foliation, banding, layering, and fabric are evident.</p> <p>The ultrasonic evaluation of elastic rock properties of intact specimens is useful for rock classification purposes and the evaluation of static and dynamic properties at small strains (shear strains <math>&lt; 10^{-4}</math> %). Older equipment only provides ultrasonic P-waves measurements, while new designs obtain both P- and S-wave velocities. When compared with wave velocities obtained from field geophysical tests, the ultrasonics results provide an index of the degree of fissuring within the rock mass. This test is relatively inexpensive to perform and is nondestructive, thus may be conducted prior to strength testing of intact cores to optimize data collection.</p>

### 8.3 QUALITY ASSURANCE FOR LABORATORY TESTING OF ROCKS

In general, the general quality assurance guidelines presented previously on the laboratory testing of soils (Chapter 7) also apply for laboratory testing of intact rock. Herein, certain precautions applicable to laboratory rock testing are presented.

#### 8.3.1 Cautions

Omissions or errors introduced during laboratory testing, if undetected, will be carried through the process of design and construction, possibly resulting in costly or unsafe facilities. Table 8-2 lists topics that should be considered and given proper attention in order that a reasonable assessment of the rock will be ascertained and an optimization of the geotechnical investigation can be realized in terms of economy, performance, and safety. Guidance in the proper handling and storage of rock cores may be found in ASTM D 5079 (Preserving & Transporting Rock Core Samples).

TABLE 8-2.

#### COMMON SENSE GUIDELINES FOR LABORATORY TESTING OF ROCKS

- 
- 
1. Provide protection of samples to avoid moisture loss and structural disturbance.
  2. Clearly indicate proper numbering and identification of samples.
  3. Storage of samples in controlled environments to prevent drying, overheating, & freezing.
  4. Take care in the handling & selection of representative specimens for testing.
  5. Consult the field logs while selecting test specimens.
  6. Recognizing disturbances & fractures caused by coring procedures.
  7. Maintain trimming & testing equipment in good operating condition.
  8. Use of proper fittings, platens, o-rings, & membranes in triaxial, uniaxial, and shear tests.
  9. Careful tolerances in trimming of ends and sides of intact cores.
  10. Document frequency, spacing, conditions, & infilling of joints and discontinuities.
  11. Maintain calibration of instruments used to measure load, deflections, temperatures, & time.
  12. Use of properly-determined loading rate for strength tests.
  13. Photo documentation of sample cores, fracture patterns, & test specimens for report.
  14. Carefully align & level all specimens in directional loading apparatuses and test frames.
  15. Record initial baselines, offsets, and eccentricities prior to testing.
  16. Save remnant rock pieces after destructive testing by uniaxial, triaxial, & direct shear.
  17. Conduct nondestructive tests (i.e., porosity, unit weight, ultrasonics) prior to destructive strength testing (compression, tensile, shear).
- 
-

## CHAPTER 9.0

### INTERPRETATION OF SOIL PROPERTIES

#### 9.1 INTRODUCTION

The results of the field and laboratory testing program must be compiled into a simplified representation of the subsurface conditions that includes the geostatigraphy and interpreted engineering parameters. Natural geomaterials are particularly difficult to quantify because they exhibit complex behavior and involve the actions and interactions of literally infinite numbers of particles that comprise the soil and/or rock mass. In contrast to the more “well-behaved” civil engineering materials, soils are affected by their initial stress state, direction of loading, composition, drainage conditions, and loading rate.

Whereas the properties of man-made materials (e.g., brick, concrete, steel) can be varied on demand, soil and rock formations have already been provided by Mother Nature, and in many cases, have been situated in-place for many thousands of years. Thus, the properties of soil and rock properties must be evaluated through a program of limited testing and sampling. In certain cases, the soil properties may be altered or changed using ground modification techniques. Moreover, in many situations, the ground conditions must be left as is because of the impracticality of addressing such large masses of material within economic and timely considerations. Therefore, a geotechnical site characterization of the geomaterials must be made using a selection of geophysics, drilling, sampling, in-situ testing, and laboratory methods.

All interpretations of geotechnical data will involve a degree of uncertainty because of the differing origins, inherent variability, and innumerable complexities associated with natural materials. The interpretations of soil parameters and properties will rely on a combination of direct assessment by laboratory testing of recovered undisturbed samples and in-situ field data that are evaluated by theoretical, analytical, statistical, and empirical relationships. Usually, there are far fewer laboratory tests than field tests because of the greater time and expense involved in conducting the lab tests. It is also more difficult to acquire a reliable set of representative and undisturbed samples of the various soil strata. Therefore, much reliance falls on the more abundant data from in-situ and field tests for evaluating and interpreting soil parameters. The application of empirical correlations and theoretical relationships should be done carefully, with due calibration and verification with the companion sets of laboratory tests, to ensure that proper site characterization is achieved. Notably, many interrelationships between engineering properties and field tests have developed separately from individual sources, with different underlying assumptions, reference basis, and specific intended backgrounds, often for a specific soil.

Emphasis in this chapter is on the interpretation of soil properties from in-situ tests for the analysis and design of foundations, embankments, slopes, and earth-retaining structures in soils. Correlation of properties to laboratory index tests and typical ranges of values are also provided to check the reasonableness of field and laboratory test results. Reference is made to the FHWA Geotechnical Engineering Circular No. 5: *Evaluation of Soil & Rock Properties* (2001) for more detailed directions on the procedures and methodologies, as well as examples of data processing and evaluation. Herein, selected procedures are presented for evaluating geostatigraphy, density, strength, stiffness, and flow characteristics. Generally, these are not unique and singular relationships because of the wide diversity of soil materials worldwide, yet intended to provide a guide to the selection of geotechnical engineering parameters that are needed in stability and deformation analyses.

## 9.2 COMPOSITION AND CLASSIFICATION

Soil composition includes the relative size distributions of the grain particles, their constituent characteristics (mineralogy, angularity, shape), and porosity (density and void ratio). These can be readily determined by the traditional approach to soil investigation using a drilling & sampling program followed by laboratory testing. Of recent, these methods are complemented by direct-push technologies that infer soil behavioral classifications, including the CPT, DMT, and others. Although no samples are obtained with these latter tests, the directly-measured readings indicate how a particular soil may react to loading, strain rate, and/or flow conditions, therefore aiding in the selection of appropriate engineering parameters. The behavior of soil materials is controlled not only by their constituents, but also by less tangible and less-quantifiable factors as age, cementation, fabric (packing arrangements, inherent structure), stress-state anisotropy, and sensitivity. In-situ tests provide an opportunity to observe the soil materials with all their relevant characteristics under controlled loading conditions.

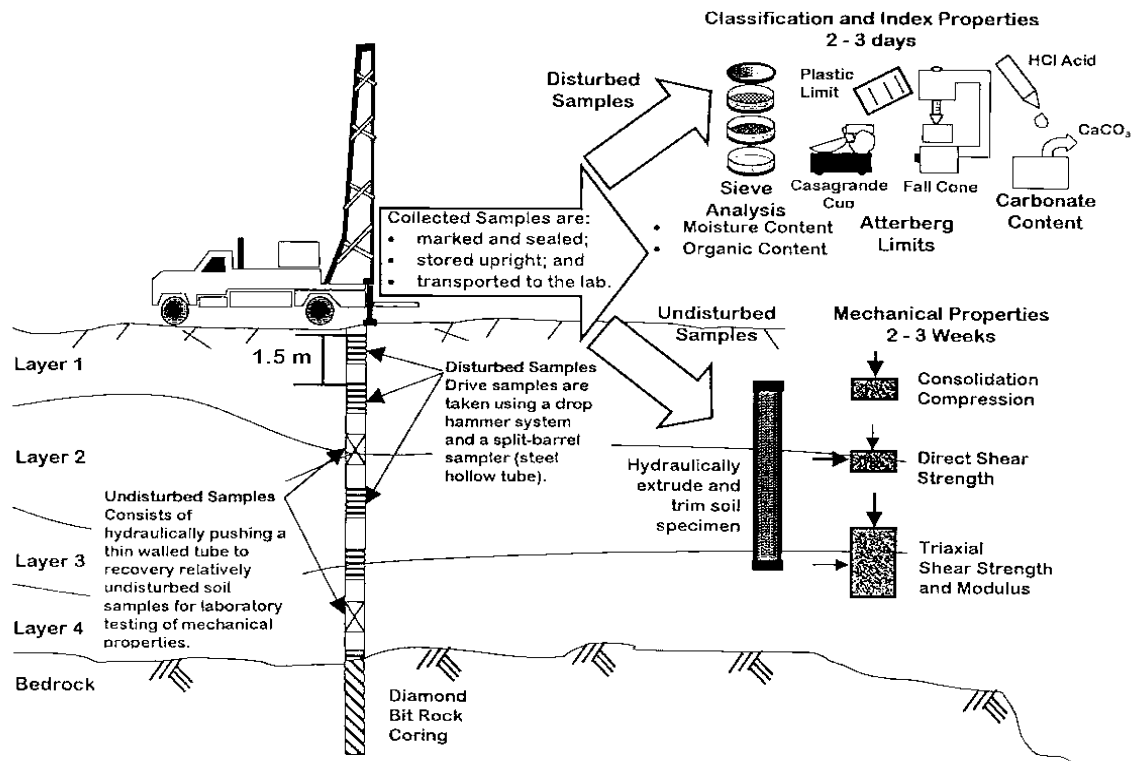
### 9.2.1. Soil Classification and Geostatigraphy

In the field, there are three approaches to soil classification and the delineation of geostatigraphy: drilling & sampling, cone penetration, and flat plate dilatometer soundings. Samples taken from the ground often undergo disturbance effects and are therefore well-suited to USCS classification techniques that require total destruction. Testing by the cone and dilatometer measure the in-situ response of soil while in its original position and environment, thus indicating a “soil behavioral” type of classification at the moment of testing. The field tests are primarily conducted by deployment of vertical soundings to determine the type, thickness, and variability of soil layers, depth of bedrock, level of groundwater, and presence of lenses, seams, inclusions, and/or voids. Traditionally, site investigations have been accomplished using rotary drilling and drive sampling methods, as depicted in Figure 9-1. Yet recently, the cone penetrometer and dilatometer have become recognized as expedient and economical exploratory tools in soil deposits. Moreover, these methods should be taken as complementary to each other, rather than substitutional.

### 9.2.2 Soil Classification by Soil Sampling and Drilling

Routine sampling involves the recovery of auger cuttings, drive samples, and pushed tubes from rotary-drilled boreholes (ASTM D 4700). The boring may be created using solid flight augers ( $z < 10$  m), hollow-stem augers ( $z < 30$  m), wash-boring techniques ( $z < 90$  m), and wire-line techniques (applicable to 200 m or more). At select depths, split-barrel samples are obtained according to ASTM D 1586 and a visual-manual examination of the recovered samples is sufficient for a general quantification of soil type (ASTM D-2488). These 0.3-m long drive samples are collected only at regular 1.5-m intervals, however, and thus reflect only a portion of the subsurface stratigraphy. Less frequently, thin-walled undisturbed tube samples are obtained per ASTM D 1587. More recently, sampling by a combination of direct-push and percussive forces has become available (e.g., geoprobe sampling; sonic drilling), whereby 25-mm diameter continuously-lined plastic tubes of soil are recovered. Although disturbed, the full stratigraphic profile can be examined for soil types, layers, seams, lenses, color changes, and other details.

For soil types, the percent fines (PF) content is a particularly important demarcation of grain sizes. Materials retained on a U.S. No. 200 sieve correspond to particles greater than 0.075 mm in diameter and termed **granular** materials. These include sands and gravels that exhibit, for the most part, mechanical properties due to normal and shearing forces. Soils passing the No. 200 sieve (smaller than 0.075 mm) are called **fines** or **fine-grained** soils. These include silt-, clay-, and colloidal-size materials that, in addition to responding to normal and shear stresses, can have properties which are significantly affected by micro-level phenomena including chemical reactions, electrical forces, capillary hydraulics, and bonding.



**Figure 9-1. Delineation of Geostatigraphy and Soil & Rock Types by Drill & Sampling Methods.**

A difficulty with the USCS system is its reliance on disaggregated and remolded samples. Natural soils exist in the ground in specially-sorted arrangements and particle assemblages, in some instances with bonded or cemented particles, complex fabric, varves, seams, layering sequences, sensitivity, and aging effects. The stress-strain-strength-time behavior of soils to loading depends in part upon these special and inherent features. The USCS makes no attempt to quantify any of the unique aspects of this in-place structure, but instead merely relies on a cumulative counting of particle sizes and two remolded indices. Consequently, there are a number of instances (e.g., marine deposits, sensitive clays, cemented sands) where the USCS fails to warn the engineer that some unusual behavioral responses or difficulties that may occur during construction in these geomaterials.

Imagine the innumerable possibilities of varied soil types when considering, for example, a clayey sand (SC). The USCS permits this classification for a predominantly sandy material having more than fifty percent of the grain size retained on a No. 200 sieve. The fines may range anywhere from 16 to 49 percent fines and the plasticity tests on material passing a No. 40 sieve fall above the A-line. The composition of the sand particles may either be quartz or feldspar or calcium carbonate or other, or alternatively, a combination of many minerals. The particles of sand may be angular or rounded, or subangular or subrounded. The percentage of fines may consist of silts and/or clays of different mineralogies (e.g., illite, kaolin, montmorillonite, smectite, diatoms, or other). These combinations of coarse- and fine-grained particles may have been placed together in recent times (e.g., Holocene soil < 10,000 years ago) or existed as a more aged soil that weathered into its present makeup many millennia ago (e.g., Cretaceous soil < 120 million years ago). The clayey sand may exist under loose and normally-consolidated conditions as an

intact material, or perhaps became heavily overconsolidated to the point of being fissured, with cracks now pervasive throughout its matrix. Over time, the soil may have been subjected to freeze-thaw, desiccation, drought, flooding, groundwater chemistry, and other factors. Despite these events, use of the USCS would result in the classification of this material as “SC” without further distinction.

### 9.2.3. Soil Classification by Cone Penetration Testing

The cone penetrometer provides indirect assessments of soil classification type (in the classical sense) by measuring the response during full-displacement. During a cone penetration test (CPT), the continuously-recorded measurements of tip resistance ( $q_c$ ), sleeve friction ( $f_s$ ), and porewater pressures ( $u_b$ ) are affected by the particle sizes, mineralogy, soil fabric, age, stress state, and other factors, as depicted in Figure 9-2 (Hegazy, 1998). In contrast, laboratory methods provide a mechanical analysis by completely disassembling the soil into grouped particle sizes and remolded fines contents. In the CPT (and DMT), the natural soil behavior is reflected, thus perhaps giving a different vantage point, and alternate classification.

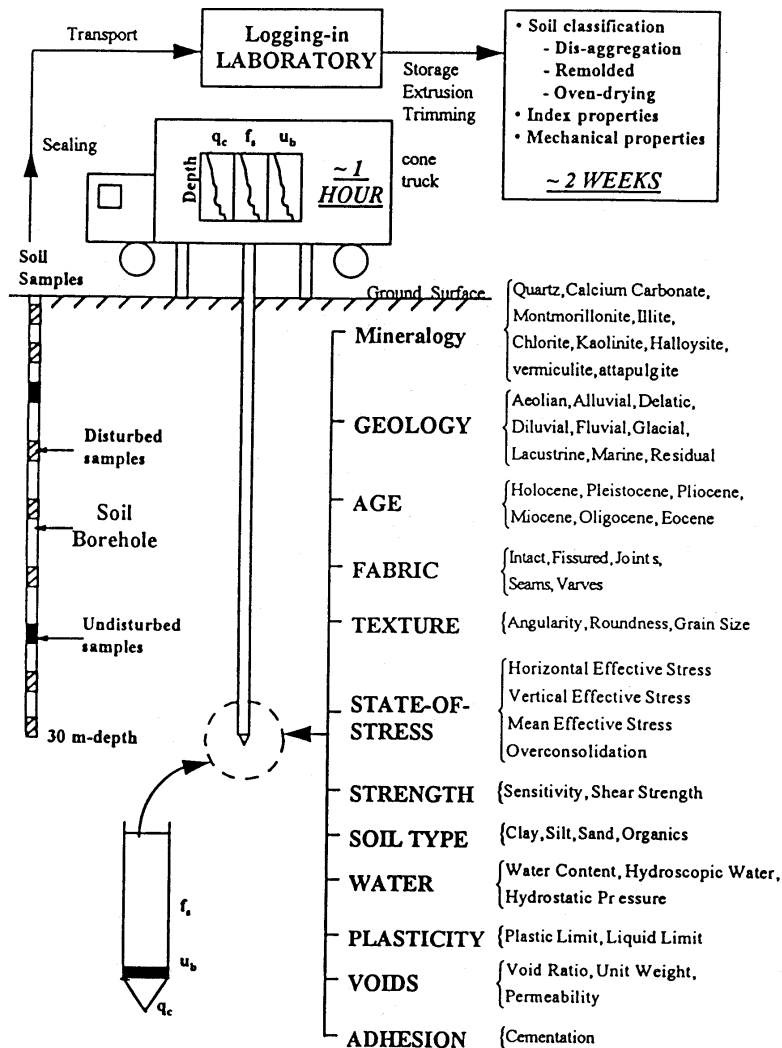


Figure 9-2. Factors Affecting Cone Penetrometer Test Measurements in Soils (Hegazy, 1998).



Soil classification by cone penetrometer involves the use of empirical charts with boundaries between data groupings of similar type. Often, a visual examination of the recorded channel outputs is sufficient to distinguish between fine-grained soils (silts and clays) and coarse-grained materials (sands). Note that the CPT is not used extensively in gravelly soils. In soft to stiff intact clays and silts, it is imperative that the tip resistance be corrected to  $q_t$  (Lunne, et al. 1997), as detailed previously in Chapter 5.2. In sands and fissured clays, the correction is often not so significant.

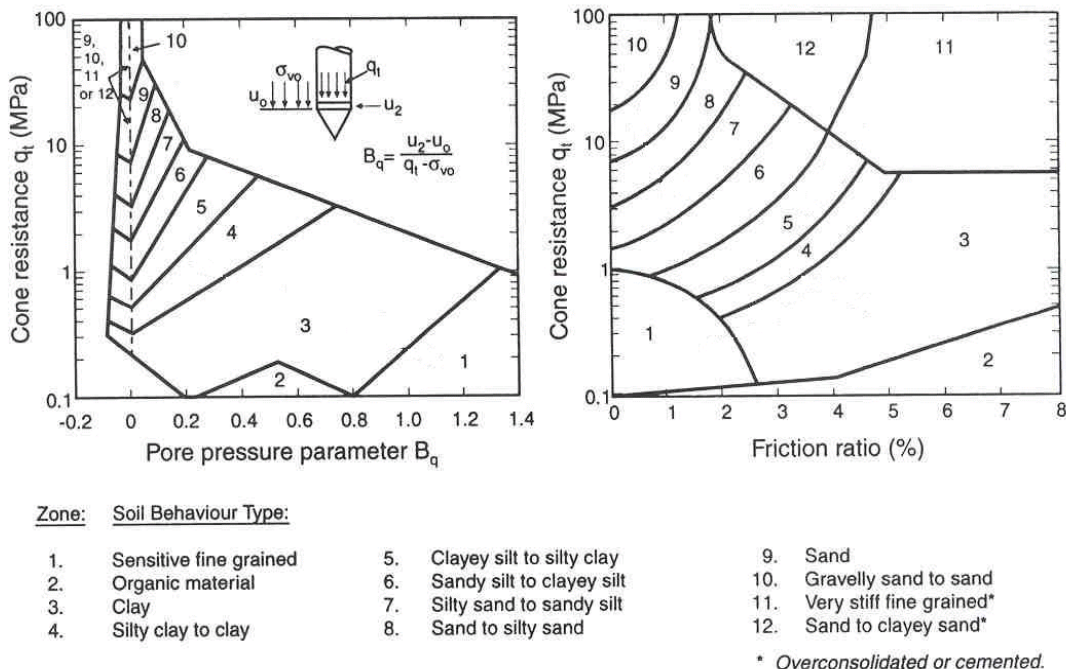
A general *rule of thumb* is that the tip stress in sands is  $q_t > 40$  atm (Note: one atmosphere =  $1 \text{ kg/cm}^2 = 1 \text{ tsf} = 100 \text{ kPa}$ ), while in many soft to stiff clays and silts,  $q_t < 20$  atm. In clean sands, penetration porewater pressures are near hydrostatic values ( $u_2 = u_0 = \gamma_w z$ ) since the permeability is high, while in soft to stiff intact clays, measured  $u_2$  are often 3 to 10 times  $u_0$ . Notably, in fissured clays and silts, the shoulder porewater readings can be zero or negative (up to minus one atmosphere, or -100 kPa). With the sleeve friction reading ( $f_s$ ), a processed value termed the friction ratio (FR) is used:

$$\text{CPT Friction Ratio, } FR = R_f = f_s/q_t \quad (9-1)$$

With CPT data, soil classification can be accomplished using a combination of two readings (either  $q_t$  and  $f_s$ , or  $q_t$  and  $u_b$ ), or with all three readings. For this, it is convenient to define a normalized porewater pressure parameter,  $B_q$ , defined by:

$$\text{Porewater Pressure Parameter, } B_q = \frac{u_2 - u_0}{q_t - \sigma_{vo}} \quad (9-2)$$

A chart using  $q_t$ , FR, and  $B_q$  is presented in Figure 9-3, indicating twelve classification regions.



**Figure 9-3. Chart for Soil Behavioral Classification by CPT (Robertson, et al., 1986).**

## 9.2.4 Soil Classification by Flat Dilatometer

Soil classification by flat plate dilatometer tests (DMT) also involves a soil behavioral response. The test can be performed in clay, silt, and sand, but is not appropriate for gravels. A dimensionless material index ( $I_D$ ) is used to evaluate soil type according to the empirical rules (Marchetti, 1980):

$$\text{DMT Material Index: } I_D = (p_1 - p_o) / (p_o - u_o) \quad (9-3)$$

where  $p_o$  = corrected contact pressure and  $p_1$  = corrected expansion pressure, as detailed in Chapter 5.4. For the DMT, the soil types are distinguished by the following ranges: *Clay*:  $I_D < 0.6$ ; *Silt*:  $0.6 < I_D < 1.8$ ; *Sand*:  $1.8 > I_D$ . Values outside of the range:  $0.1 < I_D < 6$  should be checked and verified.

## 9.3 Density

### 9.3.1. Unit Weight

The calculations of overburden stresses within a soil mass require evaluations of the unit weight or mass density of the various strata. *Unit weight* is defined as soil weight per unit volume (units of  $\text{kN/m}^3$ ) and denoted by the symbol ( $\gamma$ ). *Soil mass density* is measured as mass per volume (in either  $\text{g/cc}$  or  $\text{kg/m}^3$ ) and denoted by  $D$ . In common use, the terms "unit weight" and "density" are used interchangeably. Their interrelationship is:

$$\gamma = D g \quad (9-4)$$

where  $g$  = gravitational constant =  $9.8 \text{ m/sec}^2$ . A reference value for fresh water is adopted, whereby  $D_w = 1 \text{ g/cc}$ , and the corresponding ( $\gamma_w = 9.8 \text{ kN/m}^3$ ). In the laboratory, soil unit weight is measured on tube samples of natural soils and depends upon the specific gravity of solids ( $G_s$ ), water content ( $w_n$ ), and void ratio ( $e_0$ ), as well as the degree of saturation ( $S$ ). These parameters are interrelated by the soil identity:

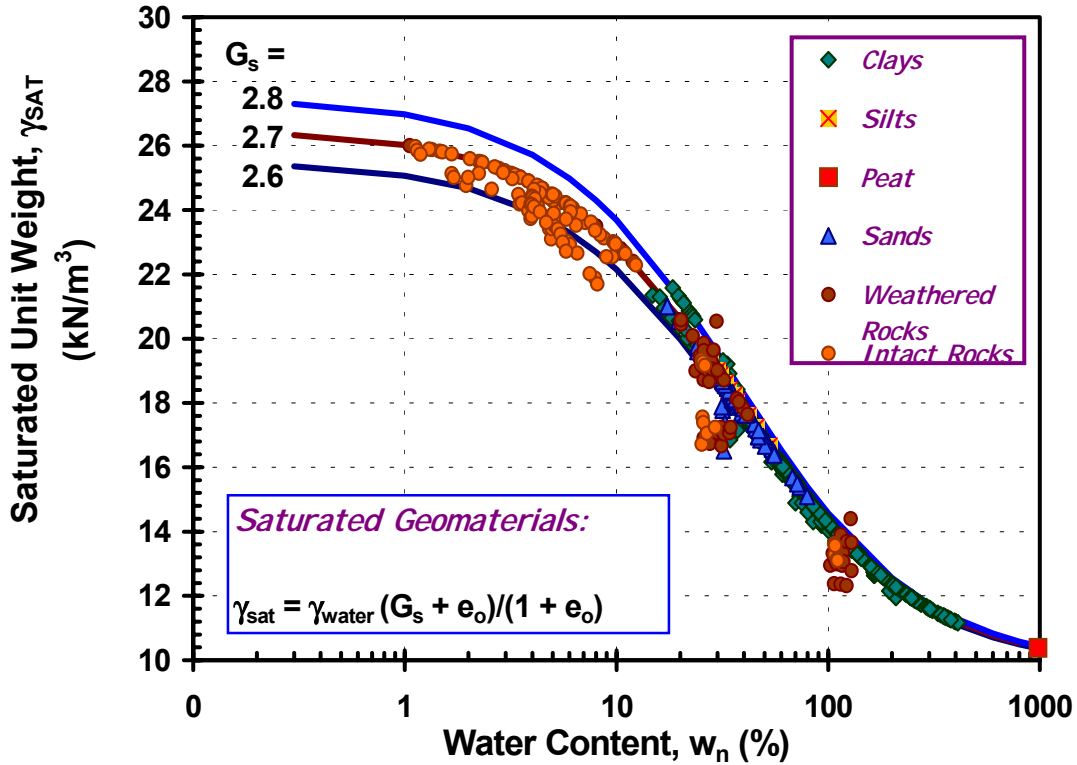
$$G_s w_n = S e_0 \quad (9-5)$$

where  $S = 1$  (100%) for saturated soil (generally assumed for soil layers lying below the groundwater table) and  $S = 0$  (assumed for granular soils above the water table). For the case of clays and silts above the water table, the soils may have degrees of saturation between 0 to 100%. Full saturation can occur due to capillarity effects and varies as the atmospheric weather. The identity relationship for total unit weight is:

$$\gamma_T = \frac{(1 + w_n)}{(1 + e_0)} G_s \gamma_w \quad (9-6)$$

When placing compacted fills, field measurements of soil mass density can be made using drive tubes (ASTM D 2937), sand cone method (ASTM D 1556), or nuclear gauge (ASTM D 2922). To obtain unit weights with depth in natural soil formations, either high-quality thin-walled tube samples (ASTM D 1587) or geophysical gamma logging techniques (ASTM D 5195) can be employed. Often, thin-walled tube sampling of clean sands is not viable. Also, sampling at great depths is time consuming and sometimes difficult. Alternatively, the values of ( $\gamma$  (and  $D$ ) may be estimated from empirical relationships. For example, since the value of  $G_s = 2.7 \pm 0.1$  for many soils, saturated unit weight can be related to the water content by combining (9-5) and (9-6) for  $S = 1$ , as illustrated in Figure 9-4. The effects of cementation, geochemical changes, sensitivity, leaching and/or presence of metal oxides or other minerals can result in differences with this trend.

## Unit Weight Evaluation of Soils & Rocks



**Figure 9-4. Interrelationship Between Saturated Unit Weight and In-Place Water Content of Geomaterials.**

During in-situ testing, the in-place water content is not normally measured directly in the field during the site exploration phase. Therefore, if data reduction is sought immediately, a surrogate measure of the in-situ water content (or void ratio) can be made via the results of shear wave velocity ( $V_s$ ) profiles. Methods for determining  $V_s$  in the field are reviewed in Section 5.7. For saturated soils, Figure 9-5 presents an observed relationship between the total unit weight ( $\gamma_T$ ) in terms of  $V_s$  and depth  $z$ . Note that for rocks and cemented materials, the trends are distinctly separate from those of particulate geomaterials. The estimation of unit weights for dry to partially saturated soils depends on the degree of saturation, as defined by (9-5) and (9-6).

The total overburden stress ( $F_{vo}$ ) is calculated from (see Section 7.1.4):

$$F_{vo} = E(\gamma_T) z \quad (9-7)$$

which in turn is used to obtain the effective vertical overburden stress:

$$F_{vo}\gamma = F_{vo} - u_0 \quad (9-8)$$

where the hydrostatic porewater pressure ( $u_0$ ) is determined from the water table (see equation 7-2).

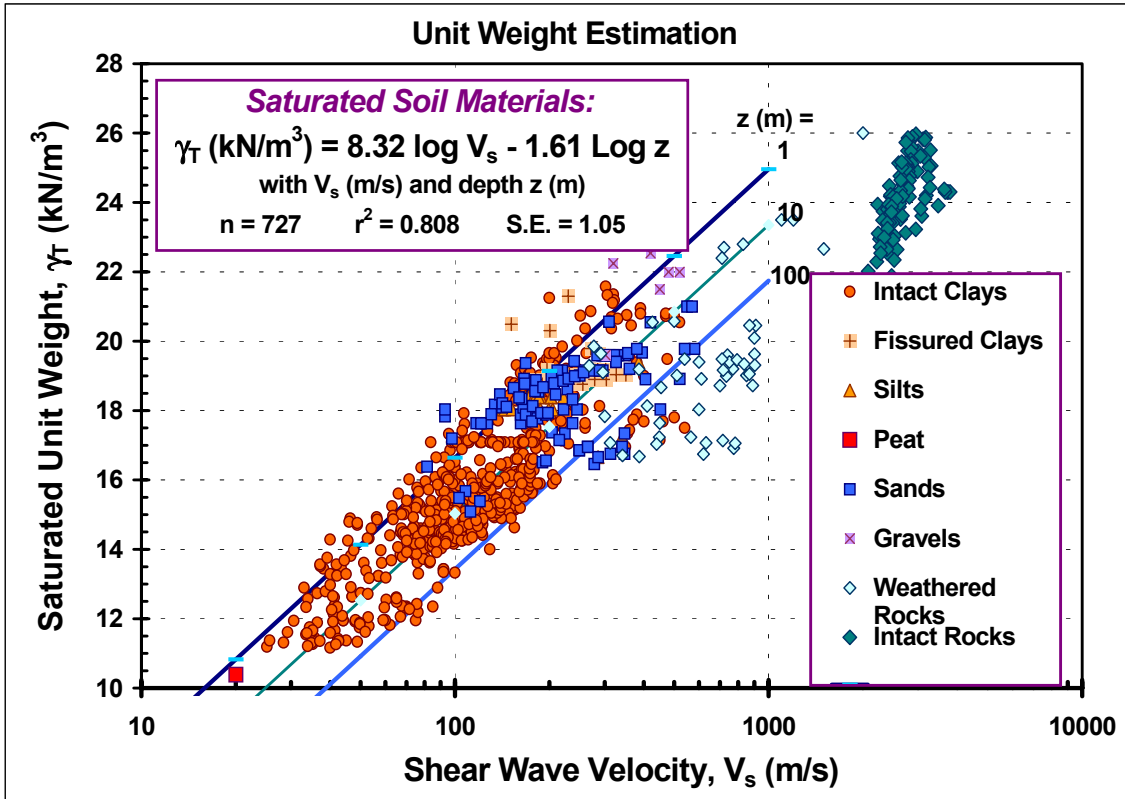


Figure 9-5. Unit Weight Relationship with Shear Wave Velocity and Depth in Saturated Geomaterials. (Note:  $n$  = number of data points;  $r^2$  = coefficient of determination; S.E. = standard error of dependent variable).

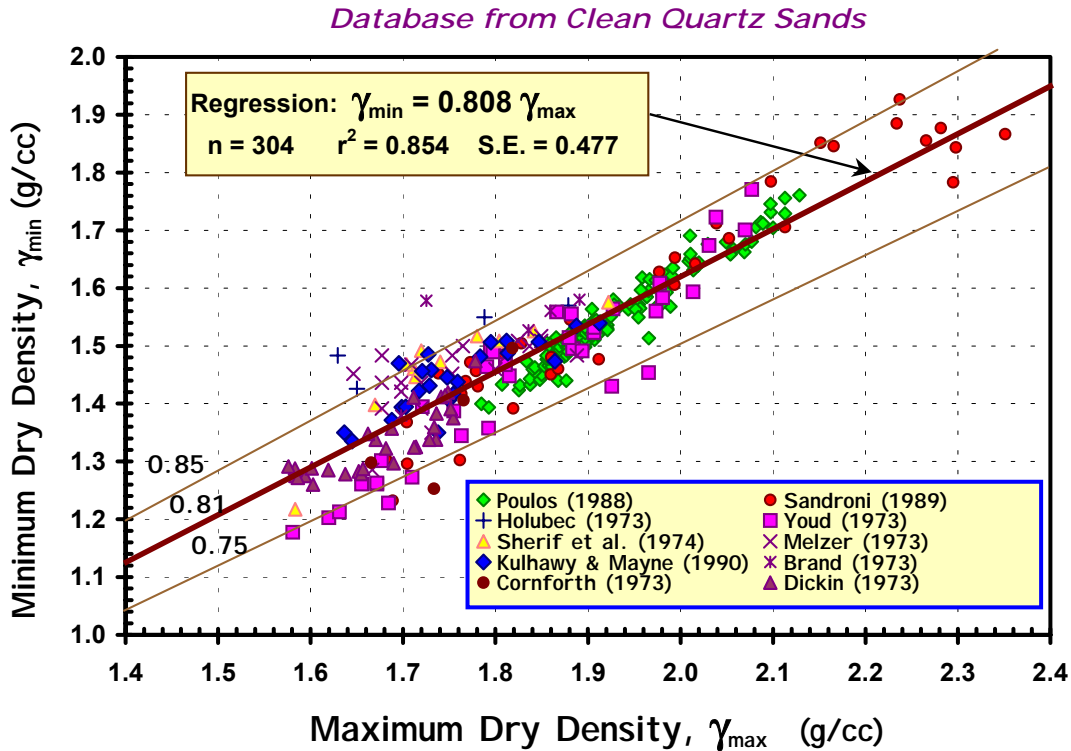
### 9.3.2. Relative Density Correlations

The *relative density* ( $D_R$ ) is used to indicate the degree of packing of sand particles and applicable strictly to granular soils having less than 15 percent fines. The relative density is defined by:

$$D_R = \frac{e_{\max} - e_0}{e_{\max} - e_{\min}} \quad (9-9)$$

where  $e_{\max}$  = void ratio at the loosest state (ASTM D 4254) and  $e_{\min}$  = void ratio at the densest state (ASTM D 4253). The direct determination of  $D_R$  by the above definition is not common in practice, however, because three separate parameters ( $e_0$ ,  $e_{\max}$ , and  $e_{\min}$ ) must be evaluated. Moreover, it is very difficult to directly determine the in-place void ratio of clean sands and granular soils with depth because undisturbed sampling is generally not possible. For a given soil, the maximum and minimum void states are apparently related (Poulos, 1988). A compiled database indicates ( $n = 304$ ;  $r^2 = 0.851$ ; S.E. = 0.044):

$$e_{\min} = 0.571 e_{\max} \quad (9-10)$$



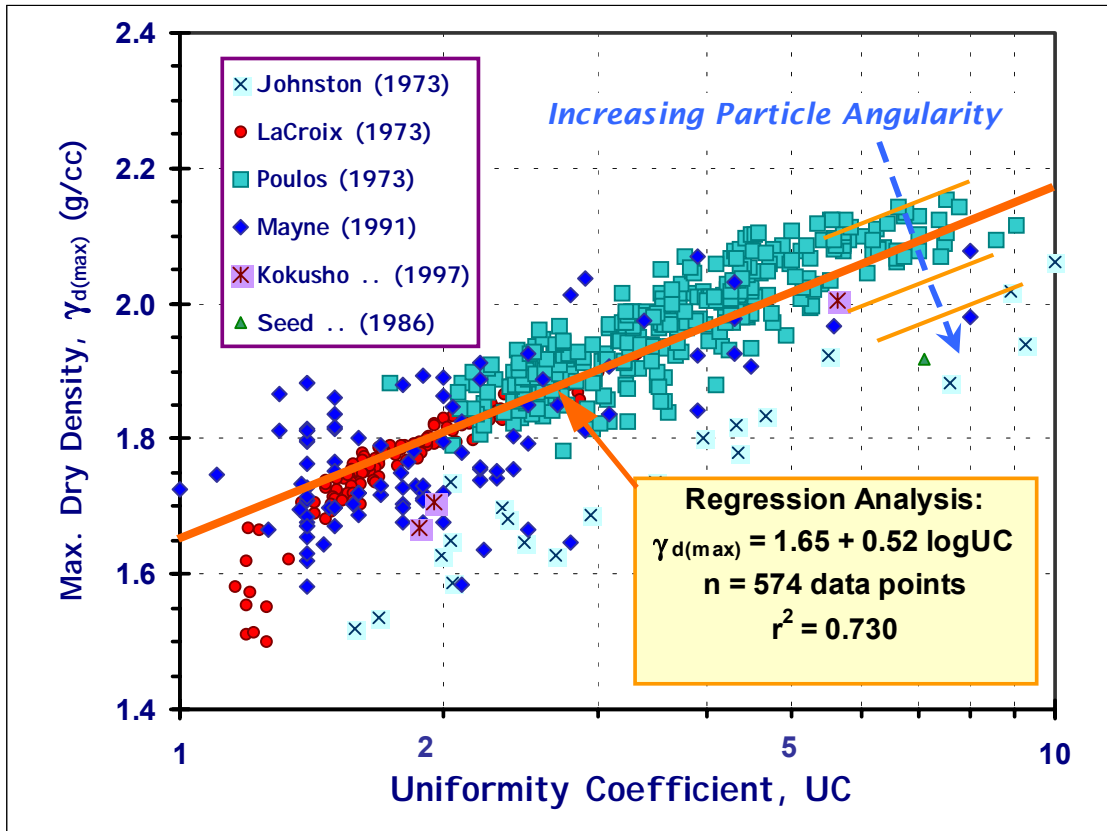
**Figure 9-6. Interrelationship Between Minimum and Maximum Dry Densities of Quartz Sands.**  
 (Note: Conversion in terms of mass density and unit weight: 1 g/cc = 9.8 kN/m<sup>3</sup> = 62.4 pcf)

For dry states ( $w = 0$ ), the dry density is given as:  $\gamma_d = G_s \gamma_w / (1+e)$  and the relationship between the minimum and maximum densities is shown in Figure 9-6 for a variety of sands. The mean trend is given by the regression line:

$$\gamma_{d (min)} = 0.808 \gamma_{d (max)} \quad (9-11)$$

Laboratory studies by Youd (1973) showed that both  $e_{max}$  and  $e_{min}$  depend upon uniformity coefficient ( $UC = D_{60}/D_{10}$ ), as well as particle angularity. For a number of sands (total  $n = 574$ ), this seems to be borne out by the trend presented in Figure 9-7 for the densest state corresponding to  $e_{min}$  and  $\gamma_{d (max)}$ . The correlation for maximum dry density  $[\gamma_{d (max)}]$  in terms of UC for various sands is shown in Figure 9-7 and expressed by ( $n = 574$ ;  $r^2 = 0.730$ ):

$$\gamma_{d (max)} = 9.8 [1.65 + 0.52 \log (UC)] \quad (9-12)$$

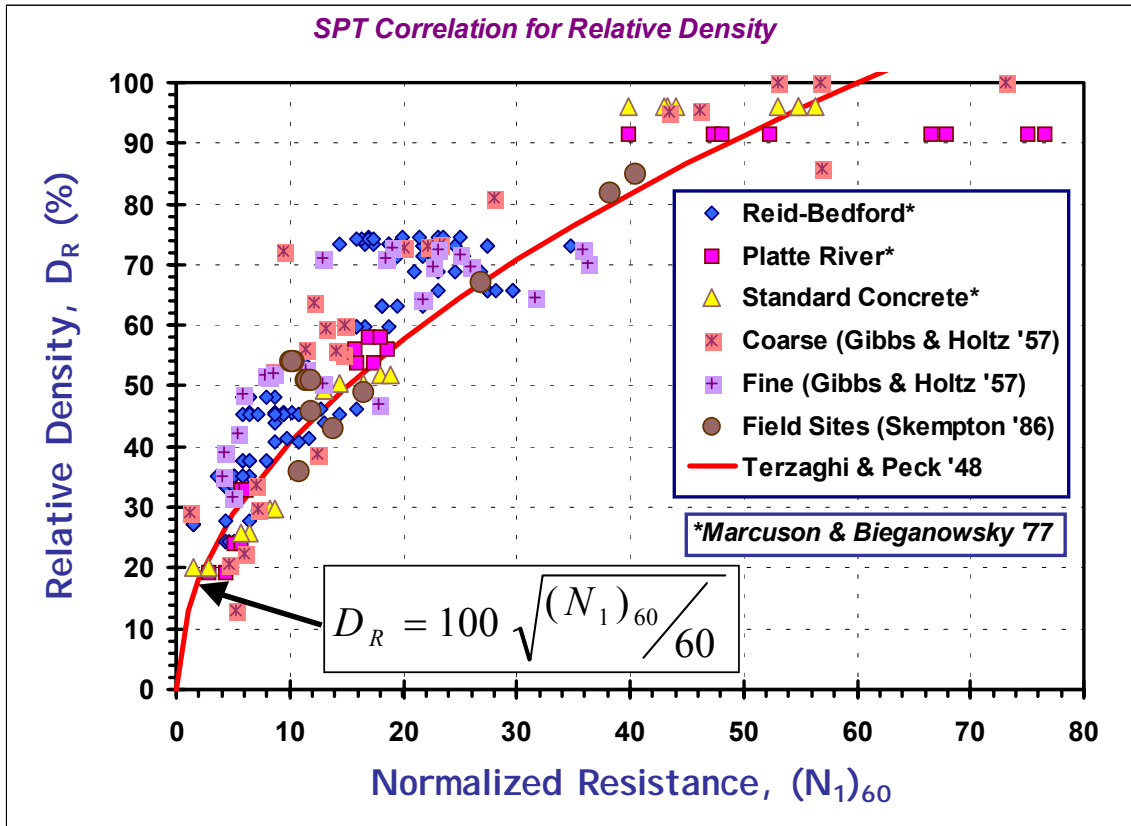


**Figure 9-7. Maximum Dry Density Relationship with Sand Uniformity Coefficient ( $UC = D_{60}/D_{10}$ ).**  
 (Note: Conversion in terms of mass density and unit weight:  $1 \text{ g/cc} = 9.8 \text{ kN/m}^3 = 62.4 \text{ pcf}$ )

From a more practical stance, in-situ penetration test data are used to evaluate the in-place relative density of sands. The original  $D_R$  relationship for the SPT suggested by Terzaghi & Peck (1967) has been re-examined by Skempton (1986) and shown reasonable for many quartz sands. The evaluation of relative density (in percent) is given in terms of a normalized resistance  $[(N_1)_{60}]$ , as shown in Figure 9-8:

$$D_R = 100 \cdot \sqrt{\frac{(N_1)_{60}}{60}} \quad (9-13)$$

where  $(N_1)_{60} = N_{60}/(F_{vo}')^{0.5}$  is the measured N-value corrected to an energy efficiency of 60% and normalized to a stress level of one atmosphere. Note here that the effective overburden stress is given in atmospheres. In a more general fashion, the normalized SPT resistance can be defined by:  $(N_1)_{60} = N_{60}/(F_{vo}'/p_a)^{0.5}$  for any units of effective overburden stress, where  $p_a$  is a reference stress = 1 bar = 1 kg/cm<sup>2</sup> = 1 tsf = 100 kPa. The range of normalized SPT values should be limited to  $(N_1)_{60} < 60$ , since above this value, apparent grain crushing occurs due to high dynamic compressive forces. Additional effects of overconsolidation, particle size, and aging may also be considered, as these too affect the correlation (Skempton, 1986; Kulhawy & Mayne, 1990).



**Figure 9-8. Relative Density of Clean Sands from Standard Penetration Test Data.**

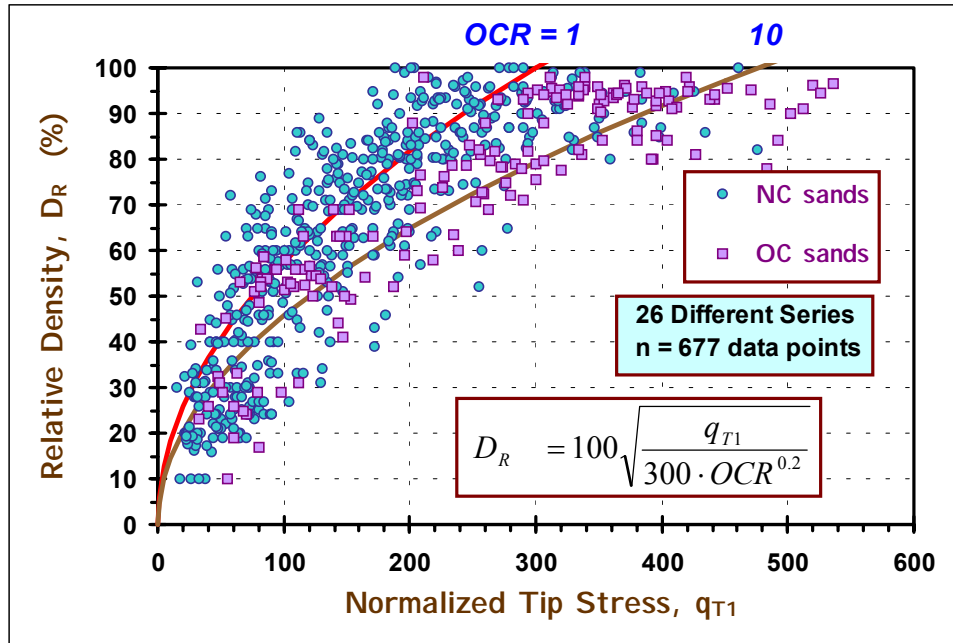
Note: normalized value  $(N_1)_{60} = N_{60}/(F_{vo}\gamma)^{0.5}$  where  $F_{vo}\gamma$  is in units of bars or tsf.

A comparable approach for the CPT can be made based on calibration chamber test data on clean quartz sands (Figure 9-9). The trends for relative density (in percent) of unaged uncemented sands are:

$$\text{Normally-Consolidated Sands: } D_R = 100 \sqrt{\frac{q_{t1}}{300}} \quad (9-14a)$$

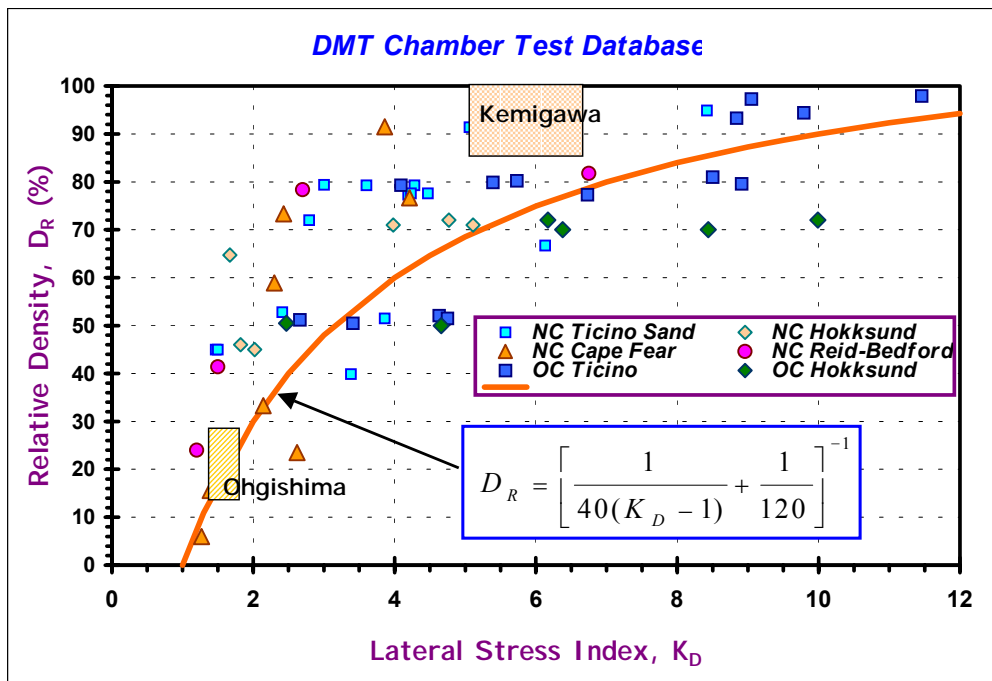
$$\text{Overconsolidated Sands: } D_R = 100 \sqrt{\frac{q_{t1}}{300 \text{OCR}^{0.2}}} \quad (9-14b)$$

where  $q_{t1} = q_c/(F_{vo})^{0.5}$  is the normalized tip resistance with both the measured  $q_c$  and effective overburden stress are in atmospheric units. The relationship should be restricted to  $q_{t1} < 300$  because of possible grain crushing effects. For any units of effective overburden stress and cone tip resistance, the normalized value is given by:  $q_{t1} = (q_t/p_a)/(F_{vo}/p_a)^{0.5}$ , where  $p_a$  is a reference stress = 1 bar . 1 kg/cm<sup>2</sup> . 1 tsf . 100 kPa . Additional effects due to overconsolidation ratio (OCR), mean particle size, soil compressibility, and aging can also be considered (Kulhawy and Mayne, 1991), but these factors are often not well quantified during routine site investigations. As indicated by Figure 9-9b, an increase in OCR in the sand will lower the apparent relative density given by eq (9-13).



**Figure 9-9. Relative Density Evaluations of NC and OC Clean Quartz Sands from CPT Data.**  
 Note: normalized resistance is  $q_{t1} = q_c / (F_{vo}')^{0.5}$  with stresses in atmospheres (1 atm . 1 tsf . 100 kPa).

Based on limited flat dilatometer tests (DMT) conducted in the field and calibration chambers, an approximate value of  $D_R$  can be obtained from the DMT lateral stress index, as given in Fig. 9-10.



**Figure 9-10. Relative Density of Clean Sands Versus DMT Horizontal Stress Index,**  
 $K_D = (p_o - u_o) / F_{vo}'$ .

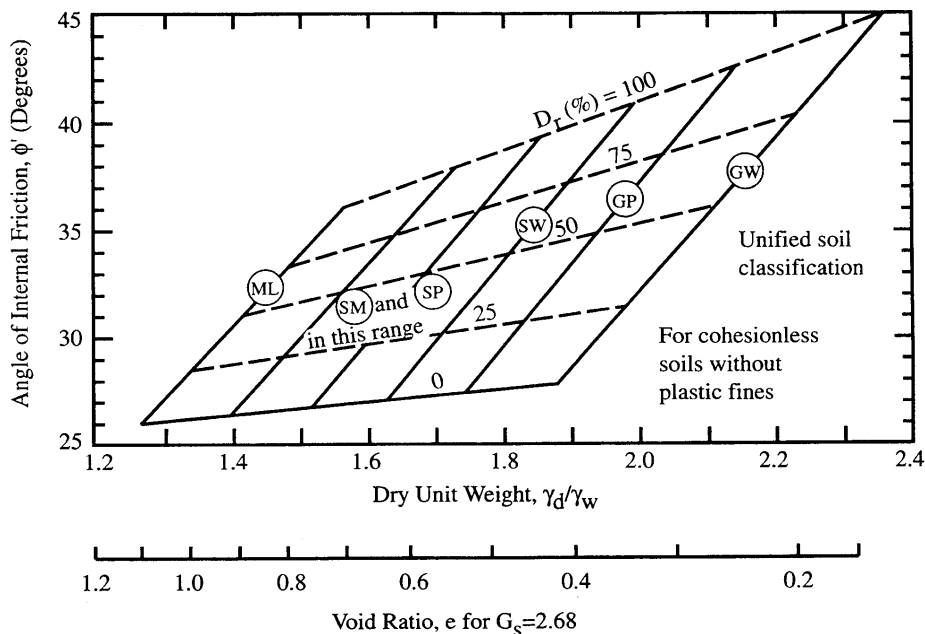


## 9.4. STRENGTH AND STRESS HISTORY

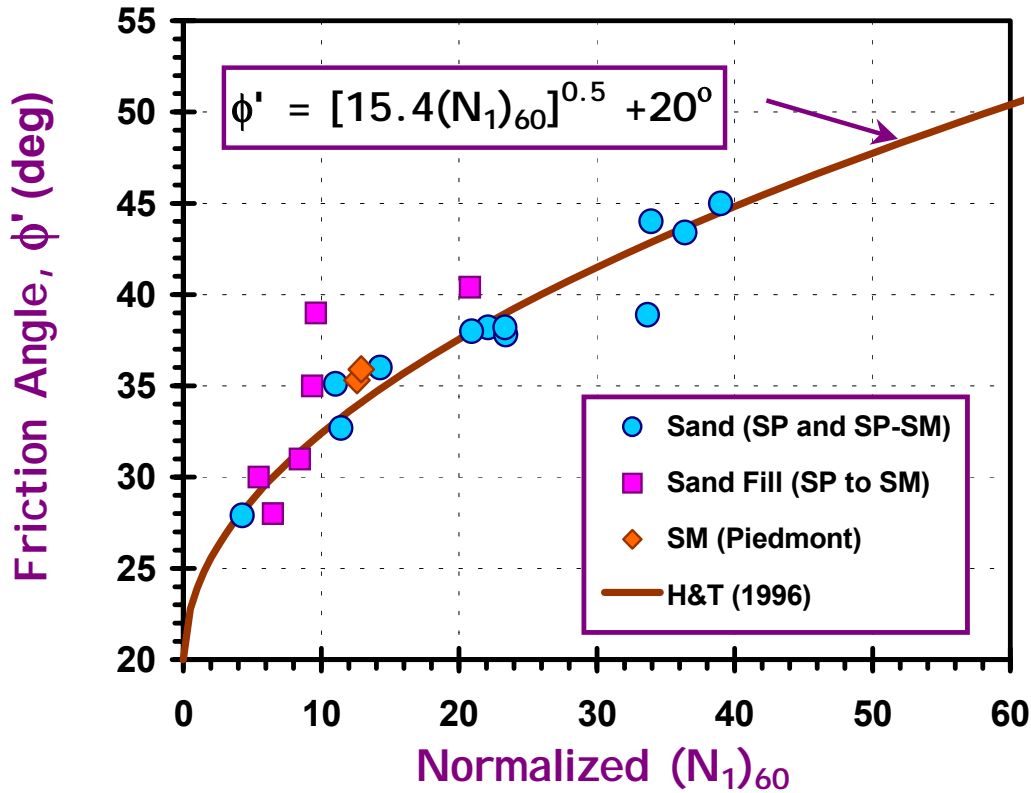
The results of in-situ test measurements are convenient for evaluating the strength of soils and their relative variability across a project site. For sands, the drained strength corresponding to the effective stress friction angle ( $N_r$ ) is interpreted from the SPT, CPT, DMT, and PMT. For short-term loading of clays and silts, the undrained shear strength ( $s_u$ ) is appropriate and best determined from normalized relationships with the degree of overconsolidation. In this manner, in-situ test data in clays are used to evaluate the effective preconsolidation stress ( $F_{pr}$ ) from CPT, CPTu, DMT, and  $V_s$ , which in turn provide the corresponding overconsolidation ratios ( $OCR = F_{pr}/F_{vo}$ ). The long-term strength of intact clays and silts is represented by the effective stress strength parameters ( $N_r$  and  $c_r = 0$ ) that are best determined from either consolidated undrained triaxial tests with porewater pressure measurements, drained triaxial tests, or slow direct shear box tests in the lab. For fissured clay materials, the residual strength parameters ( $N_{r,r}$  and  $c_{r,r} = 0$ ) may be appropriate, particularly in slopes and excavations, and these values should be obtained from either laboratory ring shear tests or repeated direct shear box test series.

### 9.4.1. Drained Friction Angle of Sands

The peak friction angle of sands ( $N_r$ ) depends on the mineralogy of the particles, level of effective confining stresses, and the packing arrangement (Bolton, 1986). Sands exhibit a nominal value of  $N_r$  due solely to mineralogical considerations that corresponds to the critical state (designated  $N_{cs,r}$ ). The critical state represents an equilibrium condition for the particles at a given void ratio and effective confining stress level. For clean quartzitic sands, a characteristic  $N_{cs,r} = 33^\circ$ , while a feldspathic sand may show  $N_{cs,r} = 30^\circ$  and a micaceous sandy soil exhibit  $N_{cs,r} = 27^\circ$ . Under many natural conditions, the sands are denser than their loosest states and dilatancy effects contribute to a peak  $N_r$  that is greater than  $N_{cs,r}$ . Figure 9-11 shows typical values of  $N_r$  and corresponding unit weights over the full range of cohesionless soils.



**Figure 9-11. Typical Values of  $N_r$  and Unit Weight for Cohesionless Soils.**  
(NAVFAC DM 7.1, 1982)



**Figure 9-12. Peak Friction Angle of Sands from SPT Resistance** (data from Hatanaka & Uchida, 1996).  
 Note: The normalized resistance is  $(N_1)_{60} = N_{60}/(F_{vo}'/p_a)^{0.5}$ , where  $p_a = 1 \text{ bar} = 1 \text{ tsf} = 100 \text{ kPa}$ .

The effective stress friction angle ( $N_r$ ) of sands is commonly evaluated from in-situ test data. In a recent program, special expensive undisturbed samples of sand were obtained by freezing and, after thawing, tested under triaxial conditions to obtain the peak  $N_r$ . These values were subsequently correlated with  $N$ -values obtained in the same boreholes and adjacent borings using the energy-corrections and normalization procedures described previously. The peak friction angles ( $N_r$ ) in terms of the  $(N_1)_{60}$  resistances are presented in Figure 9-12.

In one viewpoint, the cone penetrometer can be considered a miniature pile foundation and the measured tip stress ( $q_T$ ) represented the actual end bearing resistance ( $q_b$ ). In bearing capacity calculations, the pile end bearing is obtained from limit plasticity theory that indicates:  $q_b = N_q F_{vo} r$ , where  $N_q$  is a bearing capacity factor for surcharge and depends upon the friction angle. Thus, one popular method of interpreting CPT results in sand is to invert the expression ( $N_q = q_T / F_{vo} r = fctn N_r$ ) to obtain the value of  $N_r$  (e.g., Robertson & Campanella, 1983). One method for evaluating the peak  $N_r$  of clean quartz sands from normalized CPT tip stresses is presented in Figure 9-13.

Wedge-plasticity solutions have been developed for determining  $N_r$  of clean sands using the flat plate dilatometer test (DMT), as summarized by Marchetti (1997), and these have been recently calibrated with data from different sand types at documented experimental test sites, as shown in Figure 9-14. Theoretical curves are presented for the active ( $K_A$  case), at-rest ( $K_0$ ), and passive earth pressure conditions ( $K_p$  case), with the latter giving reasonable values of  $N_r$  compared with the experimental data.

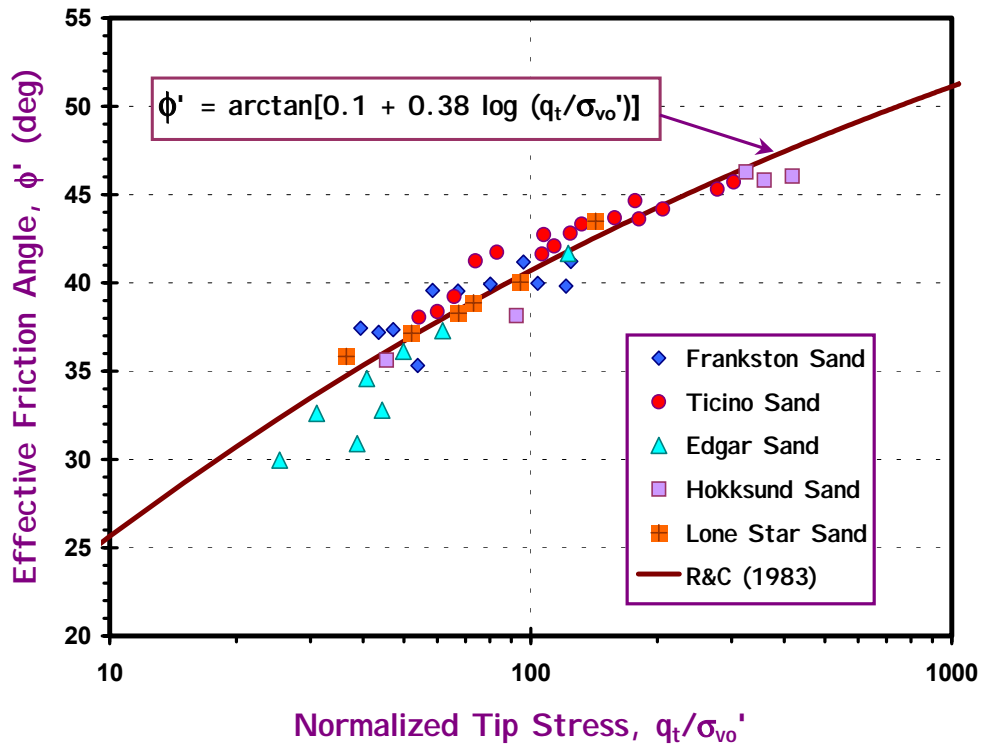


Figure 9-13. Peak Friction Angle of Unaged Clean Quartz Sands from Normalized CPT Tip Resistance. (Calibration Chamber Data Compiled by Robertson & Campanella, 1983).

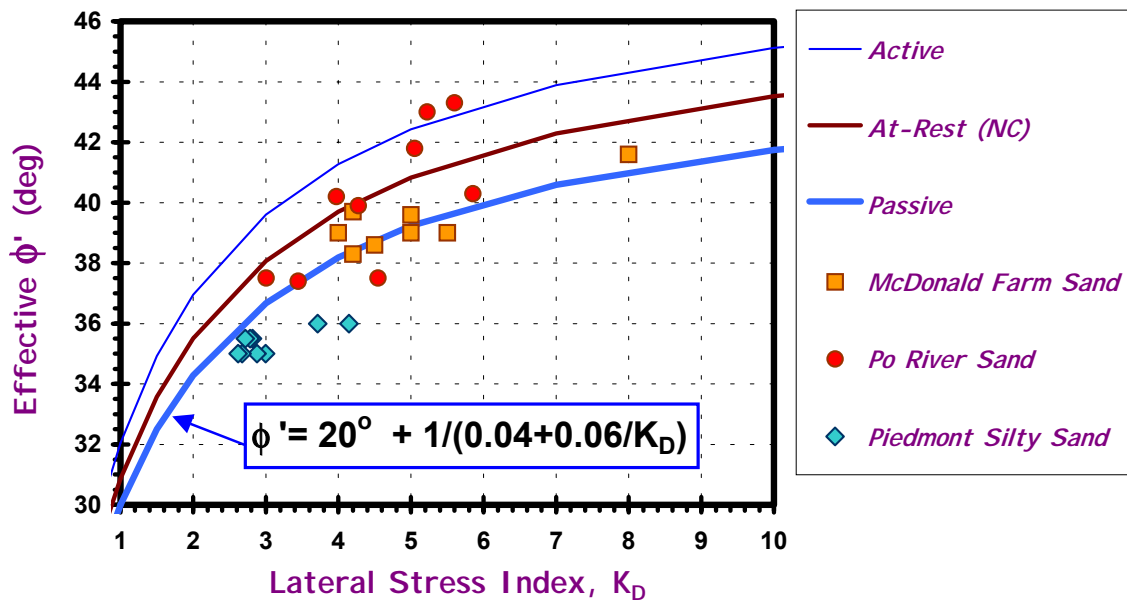
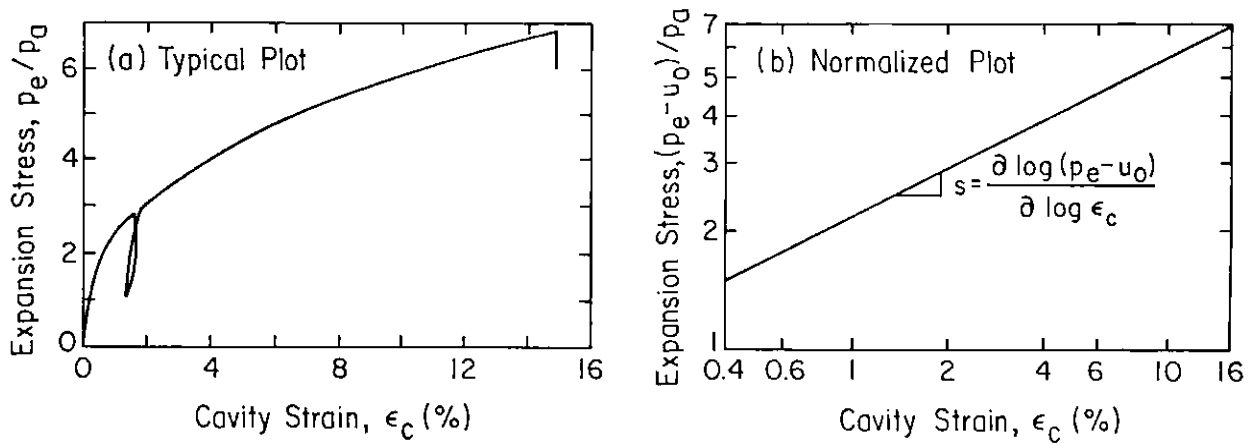


Figure 9-14. Evaluation of Peak Friction Angle of Sands from DMT Results Based on Wedge-Plasticity Solutions (Marchetti, 1997) and Experimental Data (Mayne, 2001).



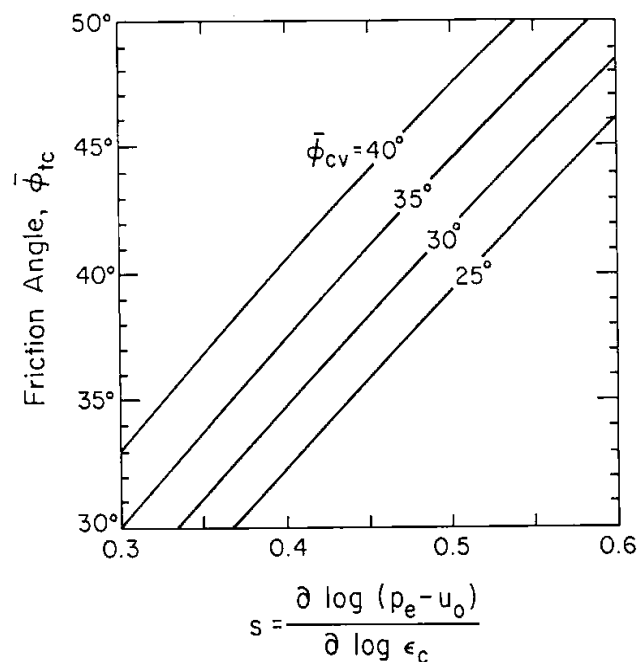
**Figure 9-15. Processing of PMT Data in Sands for Peak Nr Determination** ( after Wroth, 1984).

Note: the term  $p_a$  is a reference stress equal to one atmosphere = 1 bar . 100 kPa

The results of pressuremeter tests can be used to evaluate the strength of sands on the basis of dilatancy theory (Wroth, 1984). Figure 9-15 illustrates the processing of the measured expansion pressure curve versus measured cavity strains. Since cavity strain ( $\epsilon_c = r/r_0$ ) is directly measured during self-boring pressuremeter test (Section 5.5), a conversion to the volumetric strain ( $\epsilon_{vol} = V/V_0$ ) obtained during the more common pre-bored pressuremeter is given as:

$$\epsilon_c = (1 - \epsilon_{vol})^{-0.5} - 1 \quad (9-15)$$

On a log-log plot of effective pressure ( $p_e - u_0$ ) versus cavity strain ( $\epsilon_c$ ), the parameter  $s$  is obtained as the slope (Figure 9-15b), such that  $s = \frac{\partial \log(p_e - u_0)}{\partial \log \epsilon_c}$ . Together with the corresponding critical state  $N_{cv}$  of the sand (often taken as  $33^\circ$ ), the peak Nr for triaxial compression mode is obtained from Fig. 9-16.



**Figure 9-16. Relation Between Peak Nr for Clean Sands and Slope Parameter (s) from PMT Data.**

### 9.4.2. Preconsolidation Stress of Clays

The effective preconsolidation stress ( $F_{p,r}$ ) is an important parameter that governs the strength, stiffness, geostatic lateral stress state, and porewater pressure response of soils. It is best determined from one-dimensional oedometer tests (consolidation tests) on high-quality tube samples of the soil. Sampling disturbance, extrusion, and handling effects tend to reduce the magnitude of  $F_{p,r}$  from the actual in-place value. The normalized form is termed the overconsolidation ratio (OCR) and defined by:

$$\text{OCR} = F_{p,r}/F_{v,r} \quad (9-16)$$

Soils are often overconsolidated to some degree because they are old in geologic time scales and have undergone many changes. Mechanisms causing overconsolidation include erosion, desiccation, groundwater fluctuations, aging, freeze-thaw cycles, wet-dry cycles, glaciation, and cementation.

A representative  $e\text{-log}(F_v, \eta)$  curve obtained from one-dimensional consolidation testing on a marine clay is presented in Figure 9-17. The observed preconsolidation stress is seen to separate the recompression phase (“elastic strains”) from the virgin compression portion (primarily “plastic strains”) of the response.

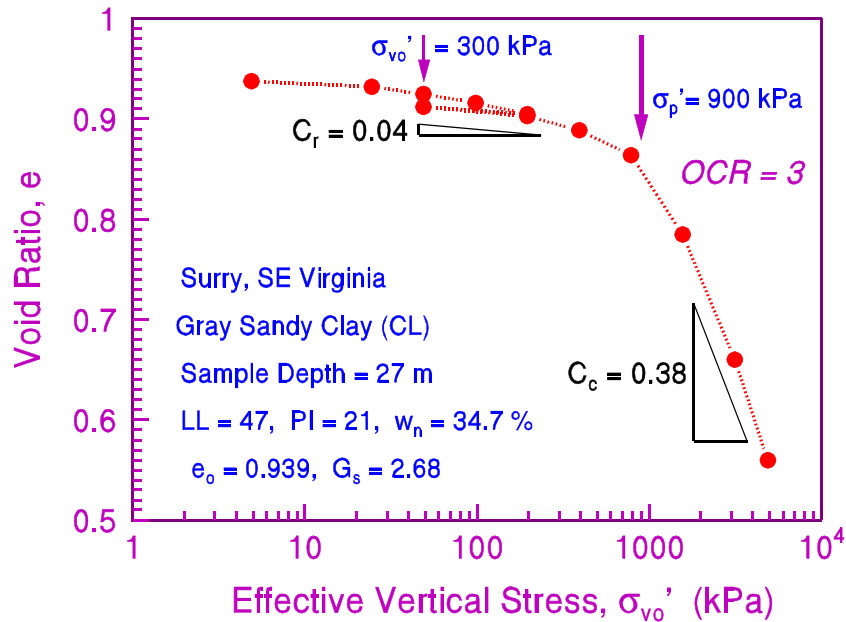
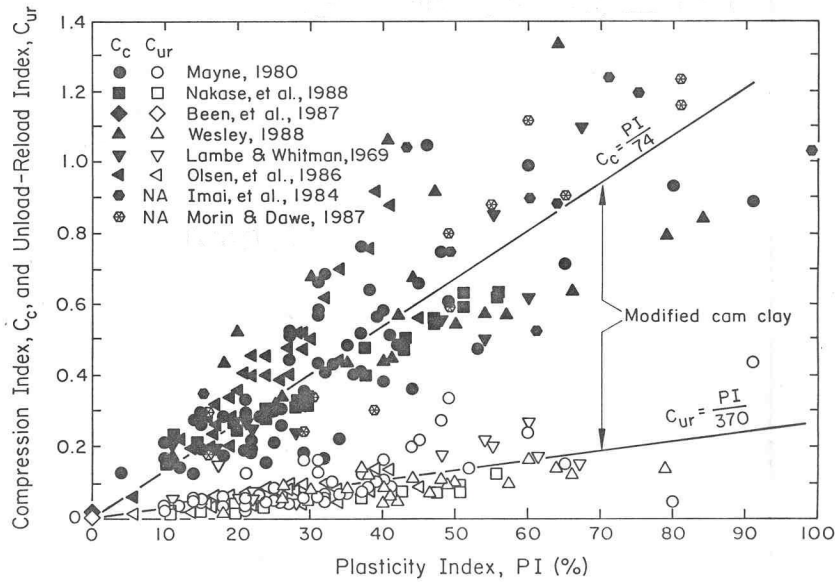


Figure 9-17. Representative Consolidation Test Results in Overconsolidated Clay

A check on the reasonableness of the obtained compression indices may be afforded via empirical relationships with the plasticity characteristics of the clay. A long-standing expression for the compression index ( $C_c$ ) in terms of the liquid limit (LL) is given by (Terzaghi, et al., 1996):

$$C_c = 0.009 (\text{LL}-10) \quad (9-17)$$

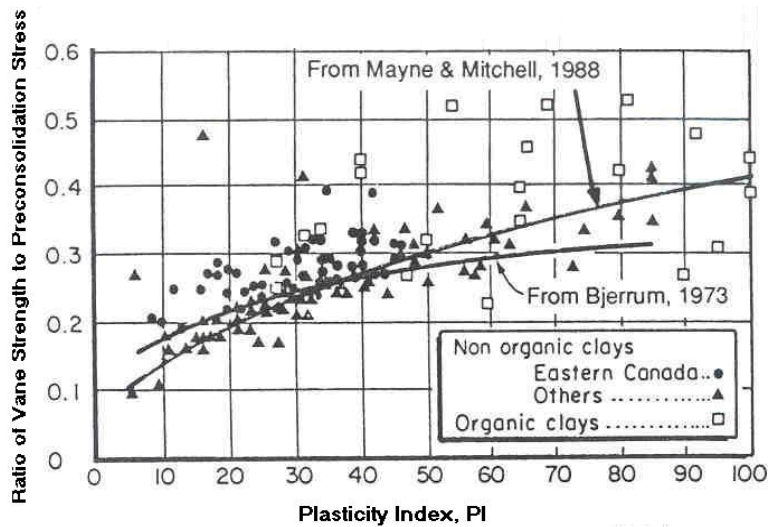
In natural deposits, the measured  $C_c$  may be greater than that given by (9-17) because of inherent fabric, structure, and sensitivity. For example, in the case in Fig. 9-17 with LL = 47, (9-17) gives a calculated  $C_c = 0.33$  vs. measured  $C_c = 0.38$  in the oedometer.



**Figure 9-18. Trends for Compression and Swelling Indices in Terms of Plasticity Index.**

Statistical expressions for the virgin compression index ( $C_c$ ) and the swelling index ( $C_{ur}$ ) from unload-reload cycles are given in Figure 9-18 in relation to the plasticity index (PI). However, it should be noted that the PI is obtained on remolded soil, while the consolidation indices are measurements on natural clays and silts. Thus, structured soils with moderate to high sensitivity and cementation will depart from these observed trends and signify that additional testing and care are warranted.

In clays and silts, the profile of preconsolidation stress can be evaluated via in-situ test data. A relationship between  $F_{pr}$ , plasticity index (PI) and the (raw) measured vane strength ( $s_{uv}$ ) is given in Figure 9-19. This permits immediate assessment of the degree of overconsolidation of natural soil deposits.



**Figure 9-19. Ratio of Measured Vane Strength to Preconsolidation Stress ( $s_{uv}/F_{pr}$ ) vs. Plasticity Index ( $I_p$ ) (after Leroueil and Jamiolkowski, 1991).**

For the electric cone penetrometer, Figure 9-20 shows a relationship for  $F_{pr}$  in terms of net cone tip resistance ( $q_t - F_{v0}$ ) for intact clay deposits. Fissured clays are seen to lie above this trend. For the piezocone,  $F_{pr}$  can be evaluated from excess porewater pressures ( $u_1 - u_0$ ), as seen in Figure 9-21.

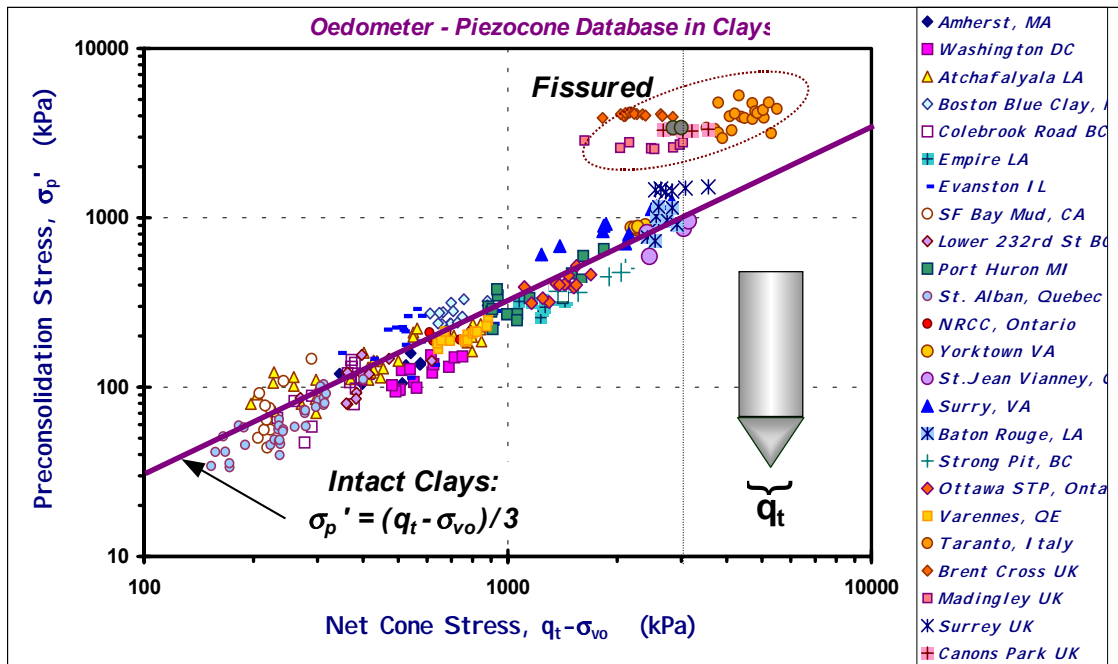


Figure 9-20. Preconsolidation Stress Relationship with Net Cone Tip Resistance from Electrical CPT.

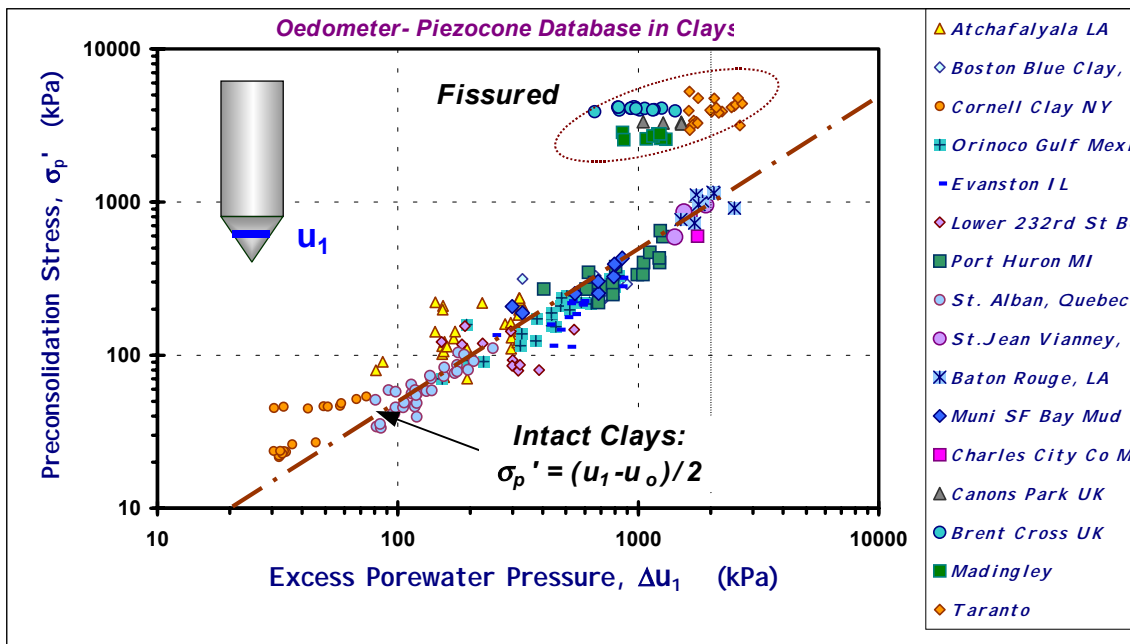


Figure 9-21. Relationship Between Preconsolidation Stress and Excess Porewater Pressures from Piezocones.

A direct correlation between the effective preconsolidation stress and effective contact pressure ( $p_0 - u_0$ ) measured by the flat dilatometer is given in Figure 9-22, again noting that intact clays and fissured clays respond differently. The shear wave velocity ( $V_s$ ) can also provide estimates of  $F_{pr}$ , per Figure 9-23. In all cases, profiles of  $F_{pr}$  obtained by in-situ tests should be confirmed by discrete oedometer results.

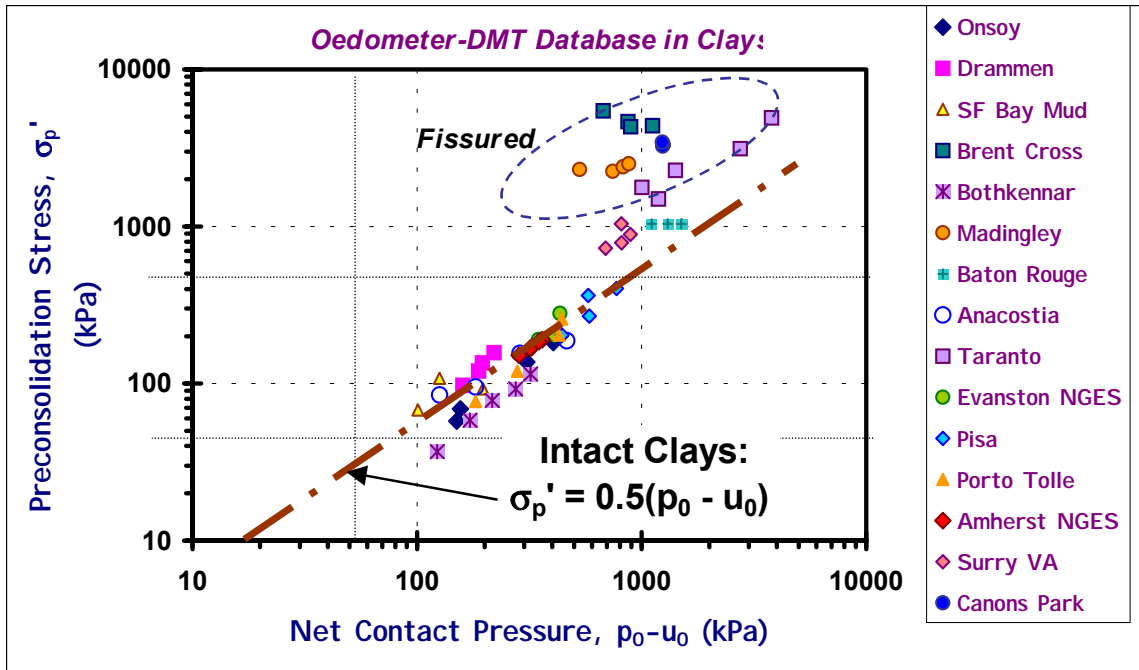


Figure 9-22. Relationship Between Preconsolidation Stress and DMT Effective Contact Pressure in Clays.

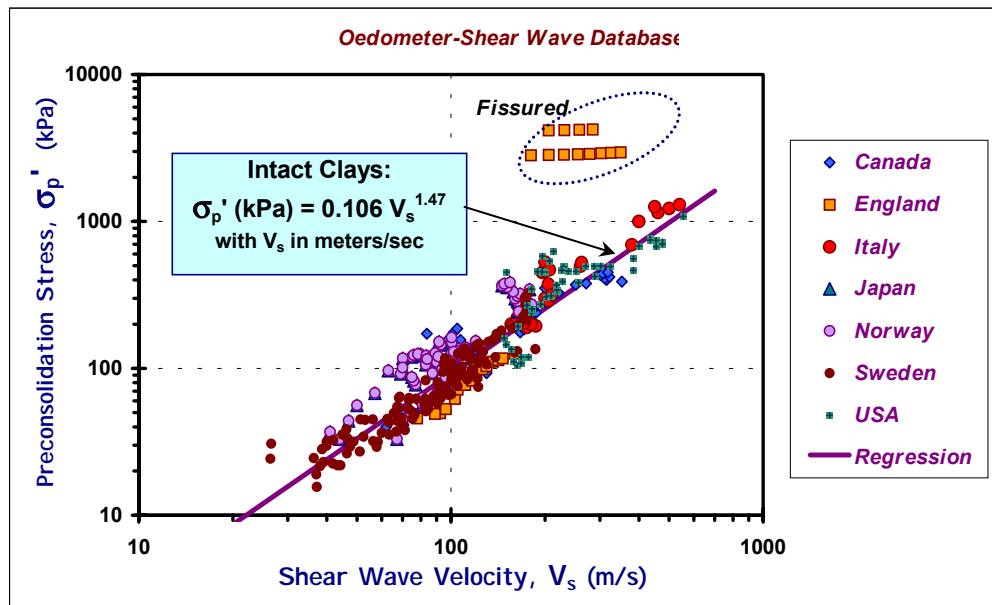
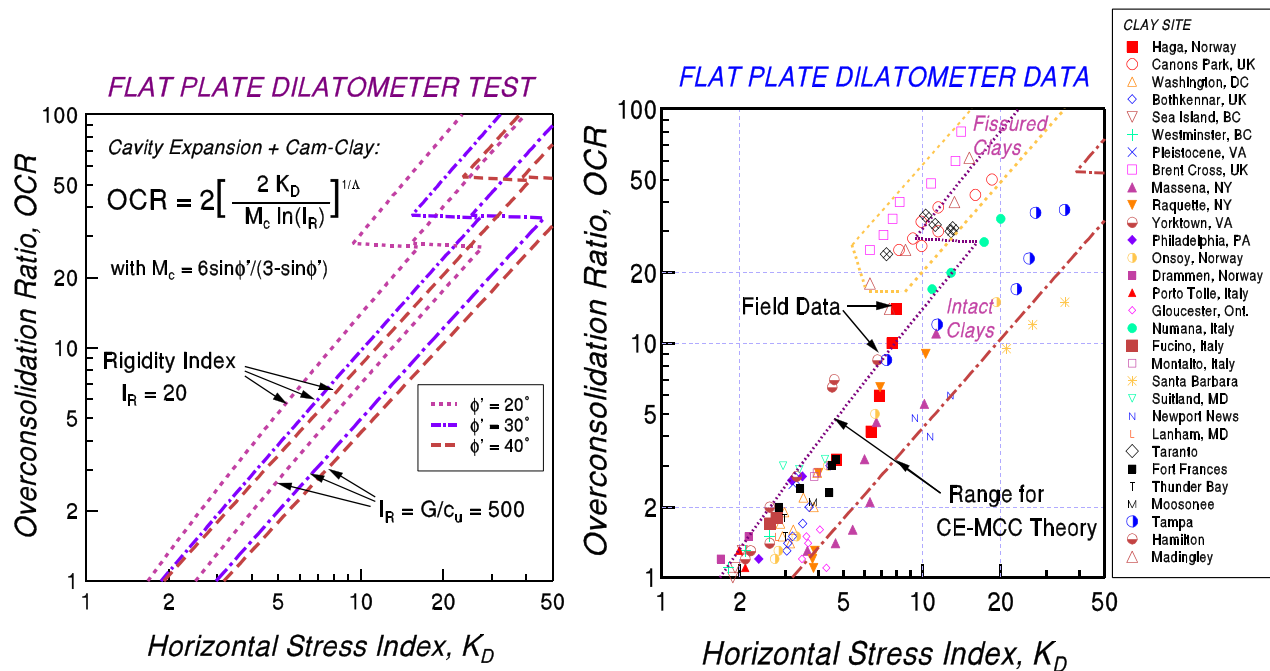


Figure 9-23. Relationship Between Preconsolidation Stress and Shear Wave Velocity in Clays. (Data from Mayne, Robertson, & Lunne, 1998)





**Figure 9-24. Relationships Between Overconsolidation Ratio and DMT Horizontal Stress Index,  $K_D$  from (a) Cavity Expansion-Critical State Theory, and (b) Worldwide Database from Clays.**

The stress history can also be expressed in terms of a dimensionless parameter, the overconsolidation ratio,  $OCR = F_p r / F_{vo} r$ . For the flat dilatometer test (DMT), the OCR can be theoretically related to the horizontal stress index [ $K_D = (p_0 - u_0) / F_{vo} r$ ] using a hybrid formulation based on cavity expansion and critical state soil mechanics, as shown in Figure 9-24a (Mayne, 2001). The relationship is not a singular expression between OCR and  $K_D$ , as has been suggested earlier (e.g., Marchetti, 1980; Schmertmann, 1986) but also depends on other clay properties and parameters, including the effective stress friction angle ( $Nr$ ), plastic volumetric strain ratio, ( $\gamma$ ), and the undrained rigidity index,  $I_R = G/s_{u0}$ , where  $G$  = shear modulus and  $s_{u0}$  = undrained shear strength. The parameter  $\gamma = 1 - C_s/C_c$ , where  $C_s$  = swelling index and  $C_c$  = virgin compression index, as obtained from one dimensional consolidation test results (Chapter 6). The parameter  $M_c$  is used to represent the frictional characteristics:  $M_c = 6 \sin Nr / (3 - \sin Nr)$ . The relationship between OCR and  $K_D$  may also depend upon other variables that have not yet been incorporated into the expression, including the age of the deposit, its fabric, structure, and mineralogy.

An important facet is whether the clay is intact or fissured. Fissuring can be caused by excessive unloading (erosion) until passive earth pressure conditions are invoked, or by extensive desiccation and other mechanisms. The degree of fissuring effectively reduces the operational strength of the clay. Consequently, when the limiting OCR has been reached (see Section 9.4.4), the above expression in Figure 9-24a has been adjusted to reflect an operational shear strength ( $s_v$ ) reduced to one-half its value for intact clays.

Compiled data from clays tested worldwide are presented in Figure 9-24b to show the general trend between OCR and  $K_D$ . The boundaries from the *Cavity Expansion-Modified Cam Clay* (CE-MCC) evaluations are superimposed to show the data fall within these ranges. In addition, using expected mean values of soil parameters ( $Nr = 30^\circ$ ,  $\gamma = 0.8$ ,  $I_R = 100$ ), results in the expression:  $OCR = (0.63 K_D)^{1.25}$  which is rather similar to the original and singular equation suggested by Marchetti (1980):  $OCR = (0.50 K_D)^{1.56}$ .

A similar approach for obtaining the OCR from piezocone test results in clays is shown in Figure 9-25, using a formulation based on CE-MCC concepts (Mayne, 1991). In this case, two separate measurements are utilized from the piezocone data ( $q_T$  and  $u_2$ ), thus reducing the number of input parameters needed in the expression. Consequently, the overconsolidation ratio is related to the normalized piezocone parameter,  $(q_T - u_2)/F_{vo}r$ , as well as the parameters  $M_c = 6 \sin Nr / (3 - \sin Nr)$  and  $\Lambda = 1 - C_g/C_c$ .

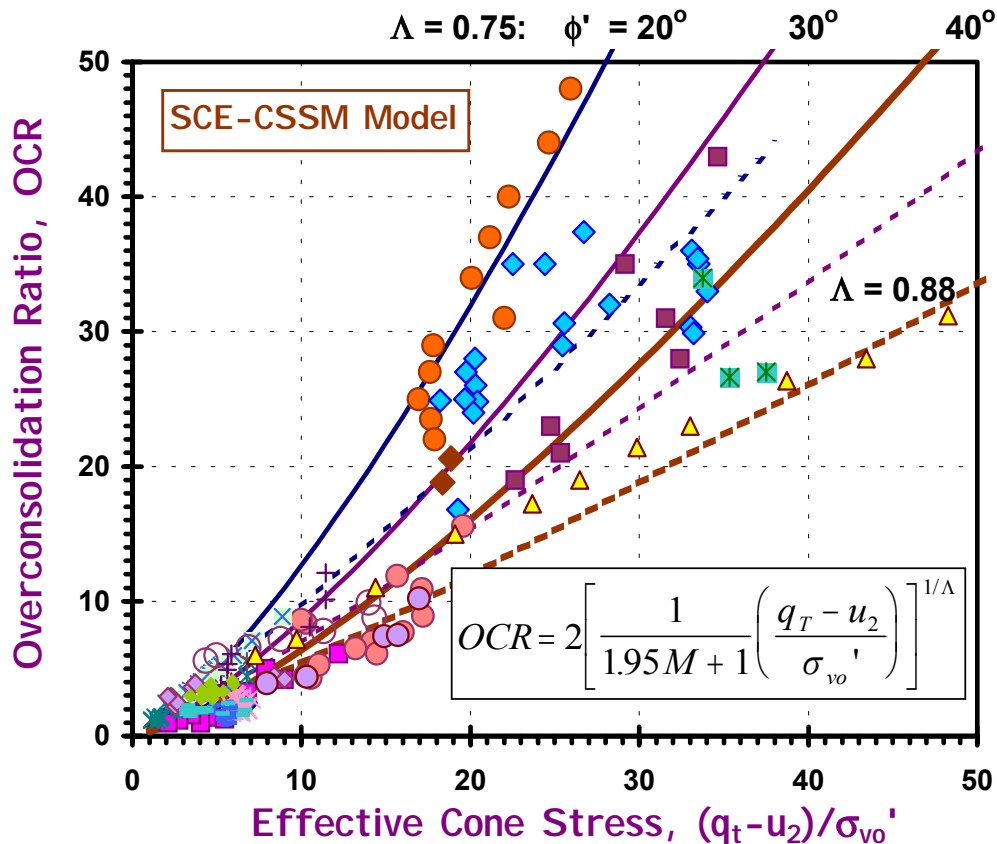
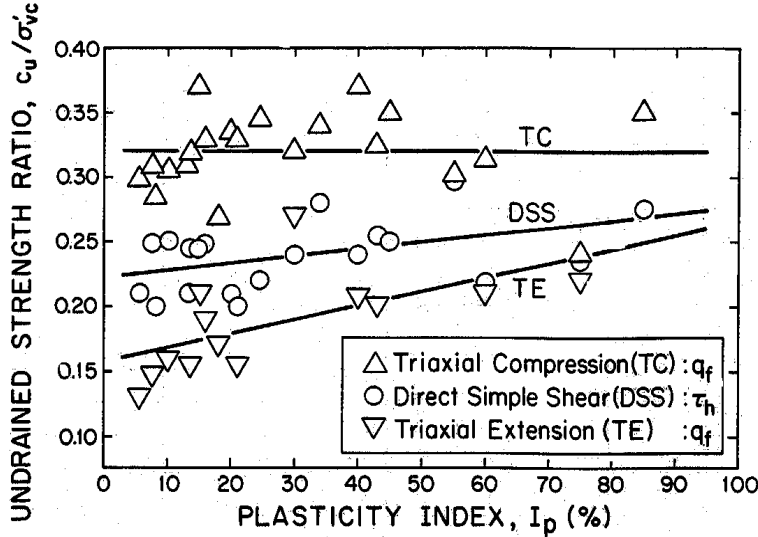


Figure 9-25. Summary Calibrations of OCR Evaluations Using Piezocone Results in Clays with Superimposed Curves from Analytical Model.

### 9.4.3. Undrained Strength of Clays & Silts

The undrained shear strength ( $s_u$  or  $c_u$ ) is not a unique property of soils, but a behavioral response to loading that depends upon applied stress direction, boundary conditions, strain rate, overconsolidation, degree of fissuring, and other factors. Therefore, it is often a difficult task to directly compare undrained strengths measured by a variety of different lab and field tests, unless proper accounting of these factors is given due consideration and adjustments are made accordingly. For example, the undrained shear strength represents the failure condition corresponding to the peak of the shear stress vs. shear strain curve. The time to reach the peak is a rate effect, such that consolidated undrained triaxial tests are usually conducted with a time-to-failure on the order of several hours, whereas a vane shear may take several minutes, yet in contrast to seconds by a cone penetrometer.

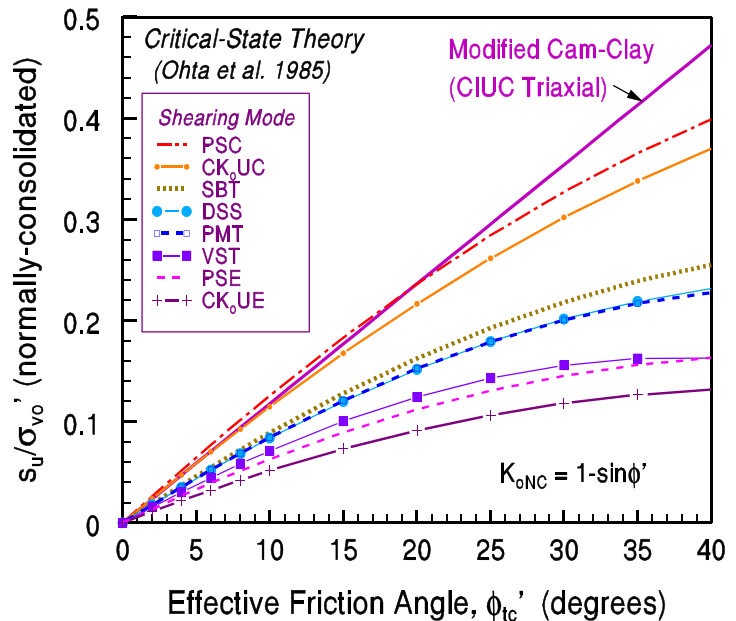
The direction of loading has a marked influence on the measured undrained strength (e.g., Jamiolkowski, et al., 1985) and this facet is known as *strength anisotropy*. The undrained strength corresponding to horizontal loading of clays (termed extension-type loading or passive mode) is less than that under vertical loading (compression or active mode). The mode of simple shear is an intermediate value and corresponds to a representative average undrained shear strength for routine design purposes (Ladd, 1991).



Since most commercial and governmental laboratories are not equipped to run series of triaxial compression (TC), direct simple shear (DSS), and triaxial extension (TE) tests, either empirical or constitutive relationships may be employed. For normally-consolidated clays & silts, Figure 9-26 shows the relative hierarchy of these modes and the observed trends with plasticity index ( $I_p$ ). In this presentation, the undrained shear strength has been normalized by the effective overburden stress level, as denoted by the ratio ( $s_u/F_{vo}r$ , or  $c_u/F_{vo}r$ ), that refers to the older  $c/pf$  ratio.

**Figure 9-26. Modes of Undrained Shear Strength Ratio ( $s_u/F_{vo}r$ )<sub>NC</sub> for Normally-Consolidated Clays** (Jamiolkowski, et al. (1985).

The theoretical interrelationships of undrained loading modes for normally-consolidated clay are depicted in Figure 9-27 using a constitutive model (Ohta, et al., 1985). The ratio for normally consolidated clay ( $s_u/F_{vo}r$ )<sub>NC</sub> increases with  $Nr$  for each of the shearing modes, including isotropically-consolidated triaxial compression (CIUC), plane strain compression (PSC), anisotropically-consolidated triaxial compression ( $CK_0UC$ ), shear box test (SBT), direct simple shear (DSS), pressuremeter (PMT), vane shear (VST), plane strain extension (PSE), and anisotropically-consolidated triaxial extension test ( $CK_0UE$ ). Laboratory data from 206 clays confirm the general nature of these relations (Kulhawy & Mayne, 1990).



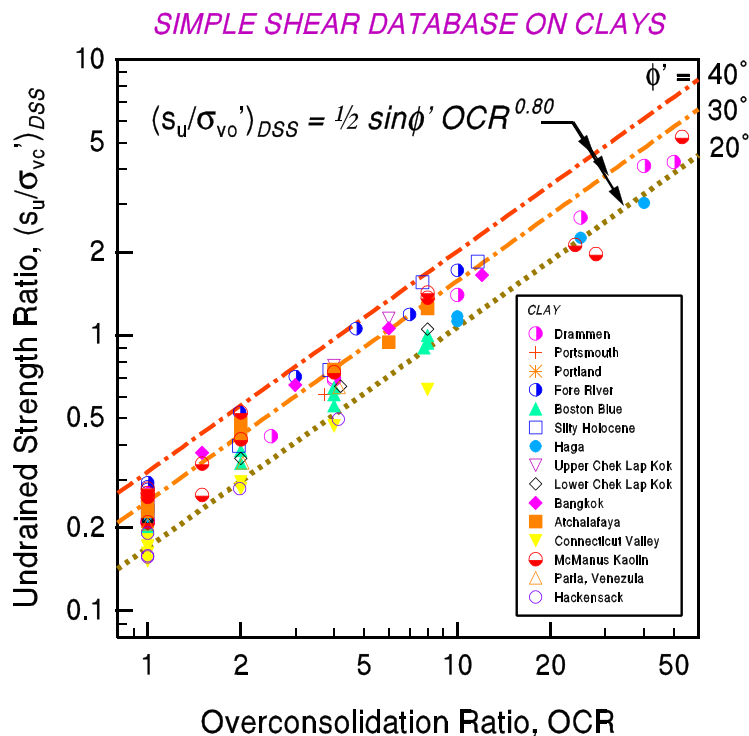
**Figure 9-27. Normalized Undrained Strengths for NC Clay Under Different Loading Modes by Constitutive Model** (Ohta, et al., 1985).

Based on extensive experimental data (Ladd, 1991) and critical state soil mechanics (Wroth, 1984), the ratio  $(s_u/F_{vo}r)$  increases with overconsolidation ratio (OCR) according to:

$$(s_u/F_{vo}r)_{OC} = (s_u/F_{vo}r)_{NC} OCR^{\Lambda} \quad (9-18)$$

where  $\Lambda = 1 - C_s/C_c$  and generally taken to be about 0.8 for unstructured and uncemented soils. Thus, if a particular shearing mode is required, it can be assessed using either Figures 9-26 or 9-27 to obtain the NC value and equation (9-17) to determine the undrained strength for overconsolidated states. In many situations involving embankment stability analyses and bearing capacity calculations, the simple shear mode may be considered an average and representative value of the undrained strength characteristics, as shown by Figure 9-28 and given by:

$$(s_u/F_{vo}r)_{DSS} = \frac{1}{2} \sin Nr OCR^{\Lambda} \quad (9-19)$$



**Figure 9-28. Undrained Strength Ratio Relationship with OCR and  $Nr$  for Simple Shear Mode.**

For intact soft clays and silts at low OCRs  $< 2$ , equation (9-18) reduces to the simple form ( $Nr = 30^\circ$ ):

$$s_u(DSS) = 0.22 F_p r \quad (9-20)$$

which is consistent with backcalculated strengths from failures of embankments, footings, and excavations, as well as the correction of vane shear strengths measured in-situ (Terzaghi, et al. 1996). Projects involving soft ground construction should utilize equation (9-19) in evaluating the mobilized undrained shear strength for design (Jamiołkowski, et al., 1985; Ladd, 1991).

### 9.4.4. Lateral Stress State

The lateral geostatic state of stress ( $K_0$ ) is one of the most elusive measurements in geotechnical engineering. It is often represented as the coefficient of horizontal stress  $K_0 = F_{ho}r / F_{vo}r$  where  $F_{ho}r =$  effective lateral stress and  $F_{vo}r =$  effective vertical stress. A number of innovative devices have been devised to measure the in-place total horizontal stress ( $F_{ho}$ ) including: total stress cell (push-in spade), self-boring pressuremeter, hydraulic fracturing apparatus, and the Iowa stepped blade. Recent research efforts attempt to use sets of directionalized shear wave measurements to decipher the in-situ  $K_0$  in soil formations.

For practical use, it is common to relate the  $K_0$  state to the degree of overconsolidation, such as:

$$K_0 = (1 - \sin \phi') OCR^{\sin \phi'} \quad (9-21)$$

which was developed on the basis of special laboratory tests including instrumented oedometer tests, triaxial cells, and split rings (Mayne & Kulhawy, 1982). Figure 9-29 shows the general applicability of (9-20) compared with direct field data measurements of  $K_0$  for clays and sands.

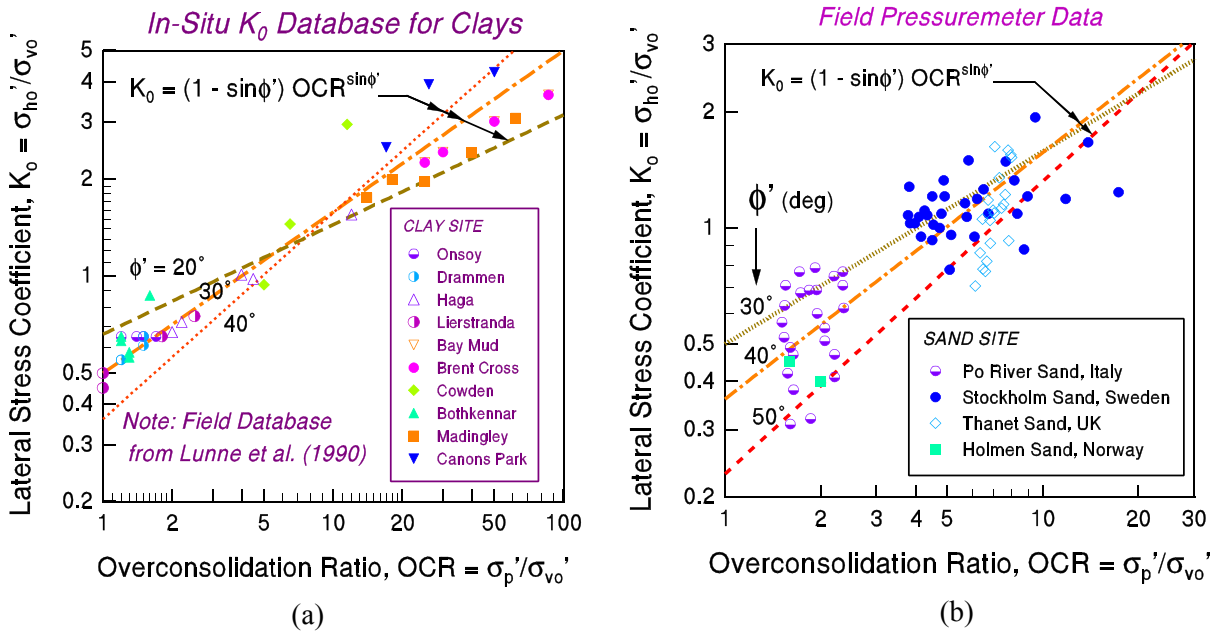


Figure 9-29. Field  $K_0$  - OCR Relationships for (a) Natural Clays and (b) Natural Sands.

In general, the value of  $K_0$  has an upper bound value limited by the passive coefficient,  $K_p$ . The simple Rankine value is given by:

$$K_p = \tan^2 (45^\circ + \frac{1}{2} \phi') = (1 + \sin \phi') / (1 - \sin \phi') \quad (9-22)$$

When the in-situ  $K_0$  reaches the passive value  $K_p$ , fissures and cracks can develop within the soil mass. This can be important in sloped masses since extensive fissuring is often associated with drained strengths that are at or near the residual strength parameters ( $N_r r$  and  $c_r r = 0$ ). In desiccated clays, fissuring can occur before the passive earth pressures are reached. In cemented materials, a value of  $K_p$  in excess of (9-22) can be achieved if bonding exists, such that:  $K_p = N_N + 2cr / F_{vo}r$  where  $N_N = (1 + \sin \phi') / (1 - \sin \phi')$ .

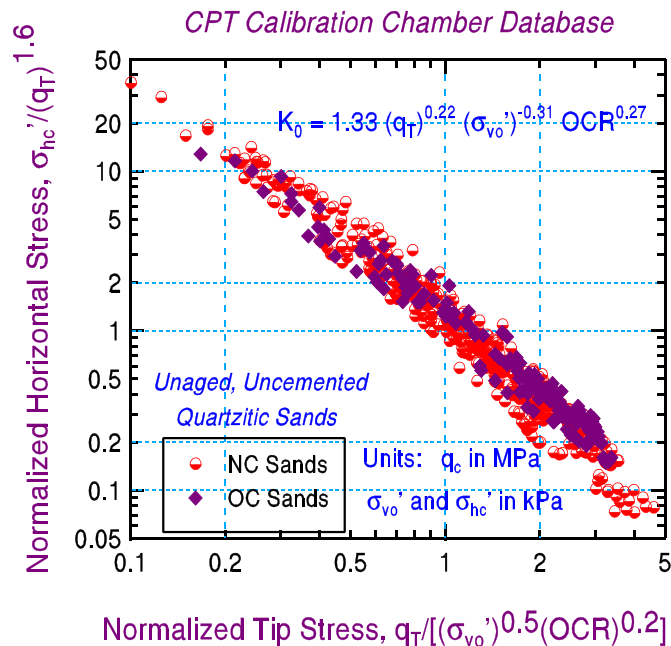
A limiting value of OCR can be defined when (9-21) equals (9-22):

$$OCR_{limit} = \left[ \frac{(1 + \sin \phi')}{(1 - \sin \phi')^2} \right]^{(1/\sin \phi')} \quad (9-22)$$

A network of fissures in the deposit can effectively reduce the operational undrained shear strength of the clay. Thus, the  $OCR_{limit}$  can be used to place upper bounds on calculated  $s_u$  values given by equations (9-18) and (9-19), as well as set upper bounds for  $K_0$  given by (9-21).

For evaluating  $K_0$  in clays, it is recommended that (9-21) be used in conjunction with the profile of OCR determined from oedometer tests and supplemented with the in-situ correlations given in Section 9.4.2. Triaxial or direct shear testing can be used to provide the relevant  $N_f$  of the material. The flat dilatometer test (DMT) has also been used for directly assessing  $K_0$  in-situ for clays, silts, and sands, and a comprehensive review of the available relationships is given by Mayne & Martin (1998).

For the determination of  $K_0$  in clean quartz sands by CPT, a calibration chamber database has been compiled and analyzed (Lunne, et al., 1997). The results have been based on statistical multiple regression studies of 26 separate sands worldwide where boundary effects of the chamber sizes were considered (Kulhawy & Mayne, 1990). Each flexible-walled calibration chamber was between 0.9 and 1.5 m in diameter with height of same magnitude. Preparation of a sand deposit in these large chambers takes approximately one week by pluviation or slurry methods. Relative densities range from about 10 % to almost 100 %. After placement, the sample is subjected to one of a variety of stress conditions using applied vertical and horizontal stresses and normally-consolidated to overconsolidated states ( $1 \leq OCRs \leq 15$ ). Tests are usually dry or saturated, with or without back pressures. The final phase is the conduct of the CPT through the center of the cylindrical specimen. The summary results of the chamber test database are presented in Figure 9-30 indicating a relationship between the applied lateral stress and measured cone tip stress.



**Figure 9-30. Relationship for Lateral Stress State Determination in Sands from CPT.**

Combining the expression from Figure 9-30 with equation (9-21), an estimate of the overconsolidation ratio of the sand can be made (Mayne, 1995, 2001):

$$OCR = \left[ \frac{1.33}{K_{oNC}} \frac{q_T^{0.22}}{(\sigma_{vo}')^{0.31}} \right]^{1/(\alpha-0.27)} \quad (9-23)$$

where  $K_{oNC} = 1 - \sin \phi$  and  $\alpha = \sin \phi$ .

### 9.5. STIFFNESS AND DEFORMATION PARAMETERS

The stiffness of soils is represented by several parameters, including consolidation indices ( $C_c$ ,  $C_r$ ,  $C_s$ ), drained moduli ( $E_r$ ,  $G_r$ ,  $K_r$ ,  $D_r$ ), undrained moduli ( $E_u$ ,  $G_u$ ), and and/or subgrade reaction coefficient ( $k_s$ ). The elastic constants are defined as per Figure 9-30. For undrained loading, no volume change occurs ( $\Delta V/V = 0$ ), while for drained loading, volumetric changes can be contractive (decrease) or dilative (increase). In some manner, all of the deformation parameters are interrelated (usually via elastic theory). For example, the recompression index ( $C_r$ ), which is often taken equal to the swelling index ( $C_s$ ), can be related to the constrained modulus ( $D_r = \Delta \sigma_v / \Delta \epsilon_v$ ) obtained from consolidation tests:

$$D_r = [(1+e_0)/C_r] \ln(10) F_{vo} r \quad (9-24)$$

which is valid for the overconsolidated portion only. When the imposed embankment loading exceeds the preconsolidation stress of the underlying natural clay such that the soil becomes normally-consolidated, the corresponding  $D_r$  would utilize  $C_c$  in equation (9-24)

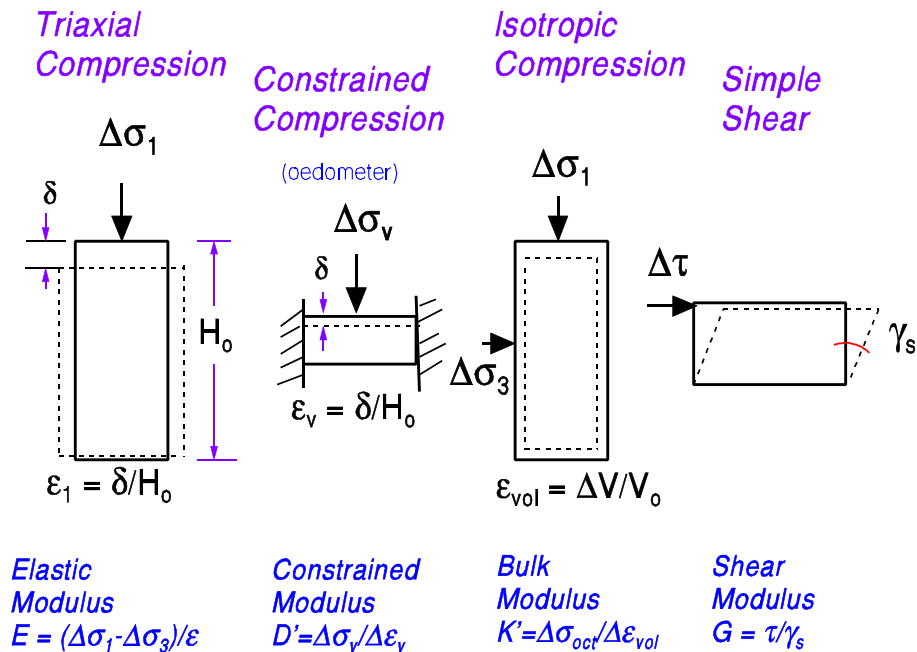


Figure 9-31. Definitions of Elastic Moduli in Terms of Loading & Applied Boundary Conditions.

The drained moduli are interrelated by the following expressions (Lambe & Whitman, 1979):

$$E_r = 2 G_r (1 + \nu_r) \quad (9-25)$$

$$D_r = E_r (1 - \nu_r) / [(1 + \nu_r)(1 - 2 \nu_r)] \quad (9-26)$$

$$K_r = E_r / [3(1 - 2 \nu_r)] \quad (9-27)$$

where  $\nu_r = 0.2$  is the drained Poisson's ratio for all types of geomaterials (Tatsuoka & Shibuya, 1992). For undrained loading, the equivalent Poisson's ratio is  $\nu_u = 0.5$ , and therefore the relationship between Young's modulus and shear modulus becomes:

$$E_u = 3 G_u \quad (9-28)$$

Note that the constrained modulus and bulk modulus are not applicable for undrained conditions.

Certain in-situ tests attempt to measure the deformation characteristics of soils directly in place, including the pressuremeter, flat dilatometer, plate load test, and screw plate. In fact, elastic theory is usually invoked for these tests to determine an equivalent elastic modulus ( $E$ ). However, major difficulties occur in assessing the appropriate magnitude of modulus due to the degree of disturbance caused during installation, degree of drainage, and corresponding level of strains imposed, particularly since the stress-strain-strength behavior of soils is nonlinear, anisotropic, and strain-rate dependent. That is, modulus is a non-singular value that varies with stress level, strain, and loading rate. In many geotechnical investigations, only the results of SPT and/or CPT are available, yet an assessment of deformation parameters is needed for settlement analyses and calculations of deflections. The penetration data reflect measurements taken late in the stress-strain response, corresponding to the strength of the material, as implicated by Figure 9-31.

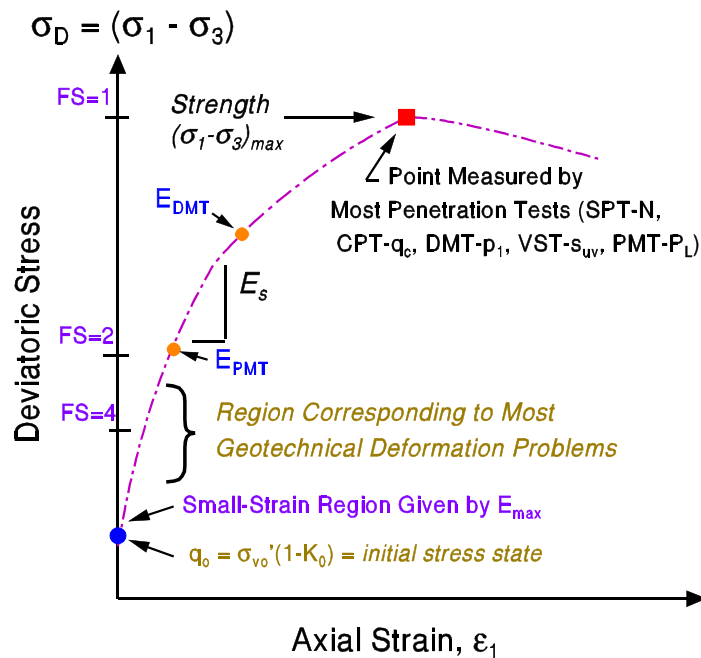


Figure 9-32. Idealized Stress-Strain Curve and Stiffnesses of Soils at Small- and Large-Strains.



The PMT and DMT provide data earlier in the stress-strain curve, yet perhaps often beyond the values of interest, unless unload-reload measurements are taken to better define an equivalent elastic region. Corresponding factors of safety (FS) from initial stress state ( $K_o$ ) to failure ( $J_{max}$ ) can be associated with the moduli, as shown in Figure 9-31. The initial stiffness is represented by the nondestructive value obtained from the shear wave velocity and provides a clear benchmark value.

### 9.5.1. Small-Strain Modulus

Recent research outside of the U.S. has found that the small-strain stiffness from shear wave velocity ( $V_s$ ) measurements applies to the initial static monotonic loading, as well as the dynamic loading of geomaterials (Burland, 1989; Tatsuoka & Shibuya, 1992; LoPresti et al., 1993). Thus, the original dynamic shear modulus ( $G_{dyn}$ ) has been re-termed the maximum shear modulus (now designated  $G_{max}$  or  $G_0$ ) that provides an upper limit stiffness given by:  $G_0 = D_r V_s^2$  where  $D_r = (\tau/g = \text{total mass density of the soil, } (\tau = \text{total unit weight (saturated value can be obtained from Fig. 9-5), and } g = 9.8 \text{ m/s}^2 = \text{gravitational constant. This } G_0 \text{ is a fundamental stiffness of all solids in civil engineering and can be measured in all soil types from colloids, clays, silts, sands, gravels, boulders, to fractured and intact rocks. The corresponding equivalent elastic modulus is found from: } E_{max} = E_0 = 2G_0(1+\nu) \text{ where } \nu = 0.2 \text{ is a representative value of Poisson's ratio of geomaterials at small strains. Shear waves can be measured by both field techniques (Section 5.7) and laboratory methods (see Figures 7-12 and 7-13).$

In certain geologic materials, it has been possible to develop calibrated correlations between specific tests (e.g., PMT, DMT) and performance monitored data from full-scale foundations and embankments. These tests provide a modulus intermediate along the stress-strain-strength curve (Fig. 9-32). Of particular note, the small-strain modulus from shear wave velocity measurements provides an excellent reference value, as this is the maximum stiffness of the soil at a given void ratio and effective confining state. Herein, a generalized approach based on the small strain stiffness from shear wave measurements will be discussed, whereby the initial modulus ( $E_0$ ) is reduced to an appropriate stress level for the desired FS.

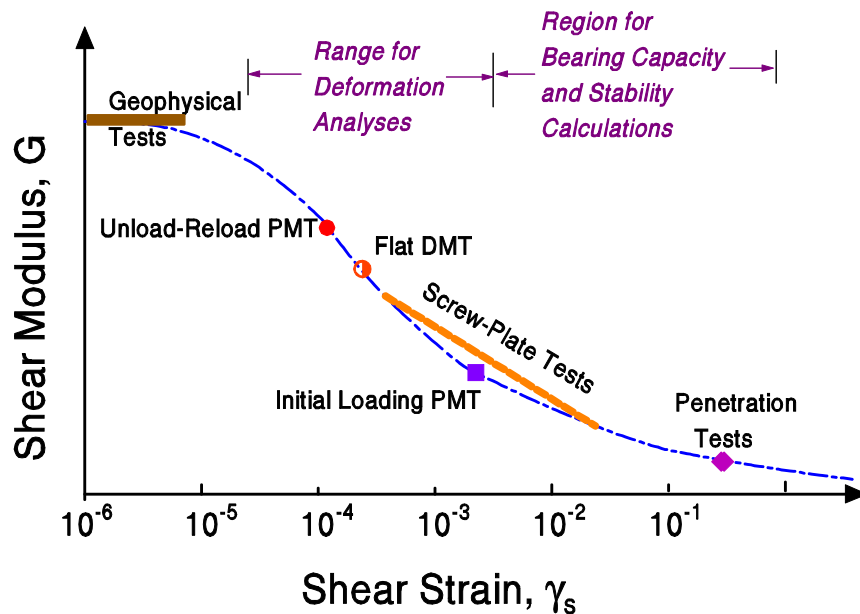


Figure 9-33. Conceptual Variation of Shear Modulus with Strain Level Under Static Monotonic Loading and Relevance to In-Situ Tests.

### 9.5.2. Modulus Reduction

Shear modulus reduction with shear strain is often shown in normalized form, with the corresponding  $G$  divided by the maximum  $G_{\max}$  (or  $G_0$ ). The relationship between  $G/G_0$  and logarithm of shear strain is well recognized for dynamic loading conditions (e.g., Vucetic and Dobry, 1991), however, the monotonic static loading shows a more severe decay with strain, as seen in Figure 9-33. The cyclic curve is representative resonant column test results, whereas the monotonic response has been only recently observed by special internal & local strain measurements in triaxial and torsional tests (e.g., Tatsuoka & Shibuya, 1992; Jamiolkowski, et al. 1994).

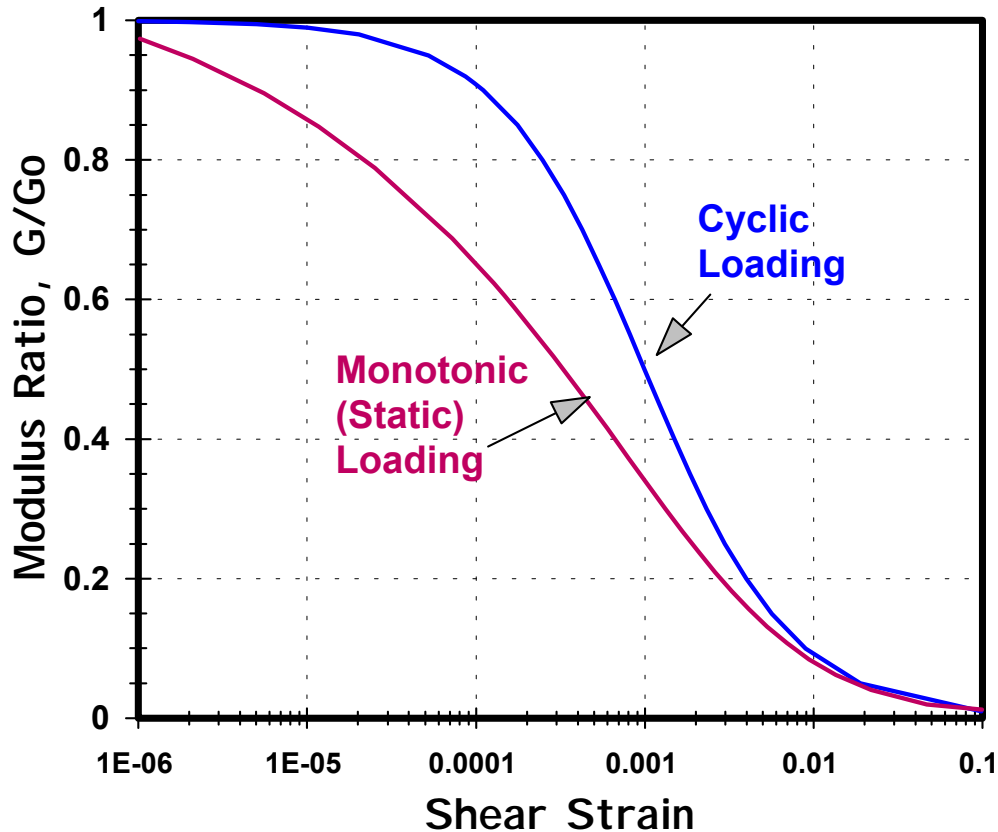
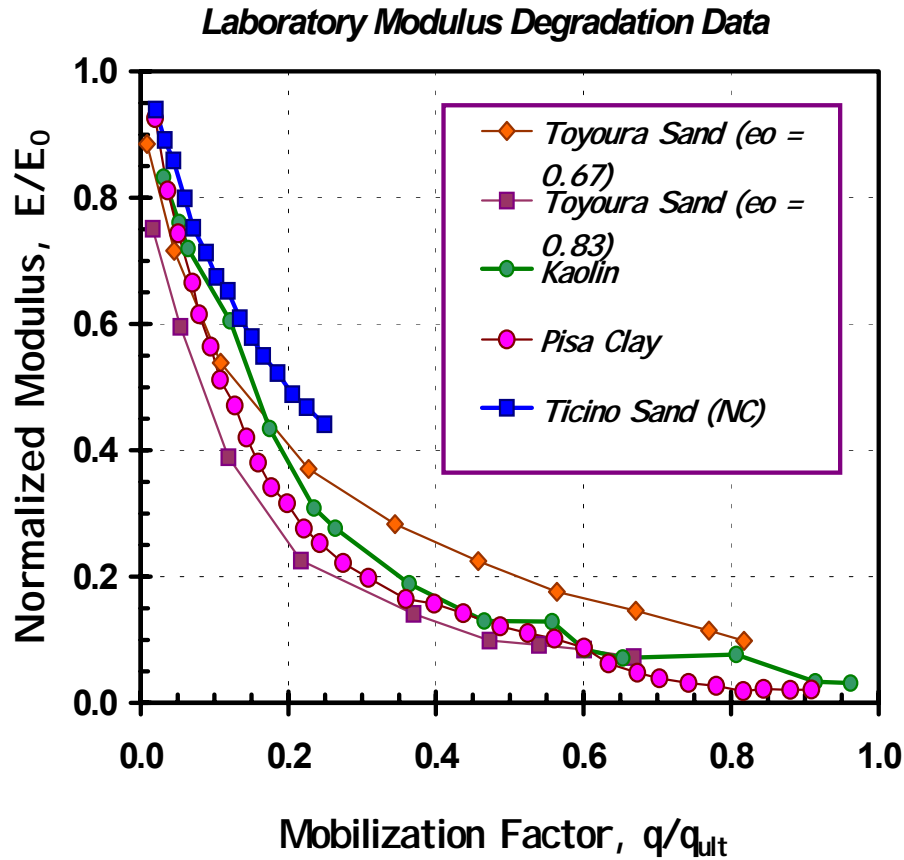


Figure 9-34. Modulus Reduction with Log Shear Strain for Initial Monotonic (Static) and Dynamic (Cyclic) Loading Conditions.

An alternate means of presenting modulus reduction is terms of shear stress level. Figure 9-34 shows a selection of normalized secant moduli ( $E/E_0$ ) with varying stress level ( $q/q_{ult}$ ) obtained from laboratory tests on uncemented, unstructured sands and clays. The stress level is expressed as  $J/J_{\max}$  or  $q/q_{ult}$ , where  $J = q = \frac{1}{2}(F_1 - F_3) =$  shear stress and  $J_{\max} = q_{ult} =$  the shear strength. The laboratory monotonic shear tests have been performed under triaxial and torsional shear conditions with local internal strain instrumentation to allow measurements spanning from small- to intermediate- to large-strain response (LoPresti, et al. 1993, 1995; Tatsuoka & Shibuya, 1992).



**Figure 9-35. Modulus Degradation from Instrumented Laboratory Tests on Uncemented and Unstructured Geomaterials.**

A modified hyperbola can be used as a simple means to reduce the small-strain stiffness ( $E_0$ ) to secant values of  $E$  at working load levels, in terms of mobilized strength ( $q/q_{ult}$ ). Figure 9-35 illustrates the suggested trends for unstructured clays and uncemented sands. The generalized form may be given as (Fahey & Carter, 1993):

$$E/E_0 = 1 - f(q/q_{ult})^g \tag{9-29}$$

where  $f$  and  $g$  are fitting parameters. Values of  $f = 1$  and  $g = 0.3$  appear reasonable first-order estimates for unstructured and uncemented geomaterials (Mayne, et al. 1999a) and these provide a best fit for the measured data shown before in Figure 9-34. The mobilized stress level can also be considered as the reciprocal of the factor of safety, or  $(q/q_{ult}) = 1/FS$ . That is, for  $(q/q_{ult}) = 0.5$ , the corresponding  $FS = 2$ .

Other numerical forms for modulus degradation are available (e.g., Duncan & Chang, 1970; Hardin & Drnevich, 1972; Tatsuoka & Shibuya, 1992) and several have a more fundamental basis or a better fitting over the full range of strains from small- to intermediate- to large-ranges (e.g., Puzrin & Burland, 1998). The intent here, however, is to adopt a simplified approach for facilitating the use of small-strain stiffness data into highway engineering practice.

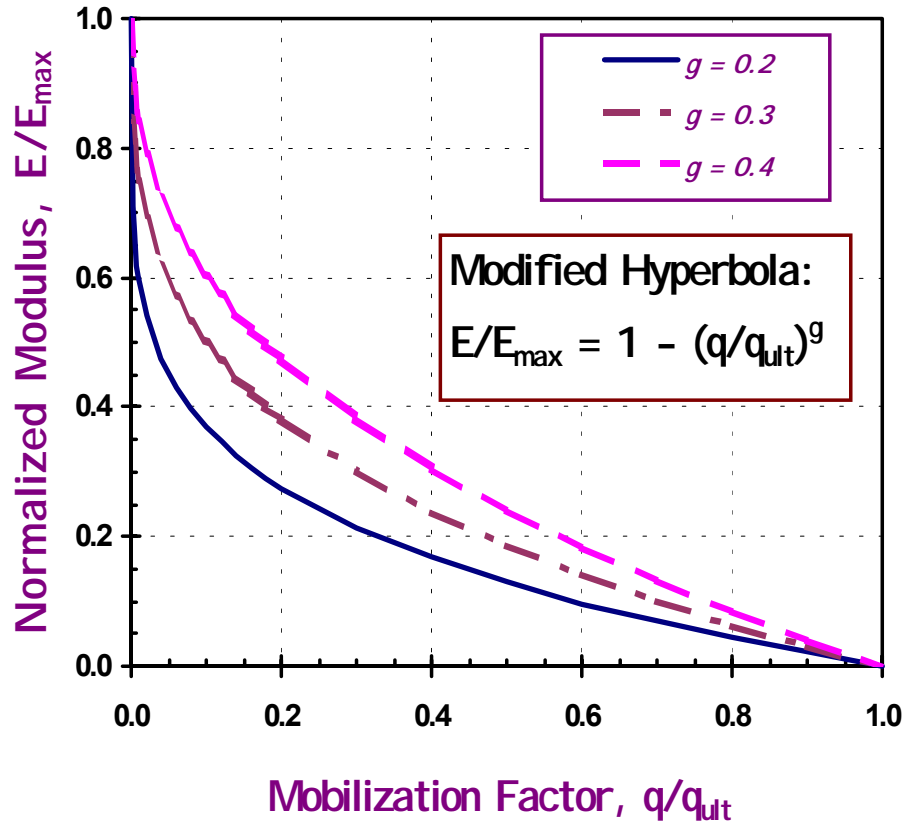


Figure 9-36. Modified Hyperbolas to Illustrate Modulus Degradation Curves (Cases shown for  $f = 1$ ). Note: Mobilized shear strength =  $q/q_u = 1/FS$ , where  $FS$  = factor of safety.

### 9.5.3. Direct and Indirect Assessments of $G_0$

It is particularly simple and economical to measure shear wave velocity profiles for determination of the small strain stiffness,  $E_0 = 2 G_0 (1 + \nu)$ , by taking  $\nu = 0.2$  and  $G_0 = D_T (V_s)^2$ . Several methods previously discussed in Chapter 5.7 include the crosshole (CHT), downhole (DHT), surface wave (SASW), as well as laboratory resonant column test (RCT). The seismic cone (Figure 9-34) and seismic dilatometer offer the advantages of collecting penetration data and geophysical measurements within a single sounding. The results shown in Figure 9-34 from Memphis, TN indicate an optimization of data collection with four independent readings including: tip stress ( $q_t$ ), sleeve friction ( $f_s$ ), porewater pressures ( $u_2$ ), and shear wave velocity ( $V_s$ ). Additional field methods for  $V_s$  profiling are in development and include: downhole suspension logging, seismic refraction, and seismic reflection. Additional lab methods for determining  $V_s$  of recent vintage include bender elements and specially-instrumented triaxial and torsional shear devices.

In some cases, direct measurements of  $G_0$  will not be available and its estimation may be required. A series of correlative relationships is given subsequently for the CPT and DMT. These correlations may be used also to check on the reasonableness of acquired data.

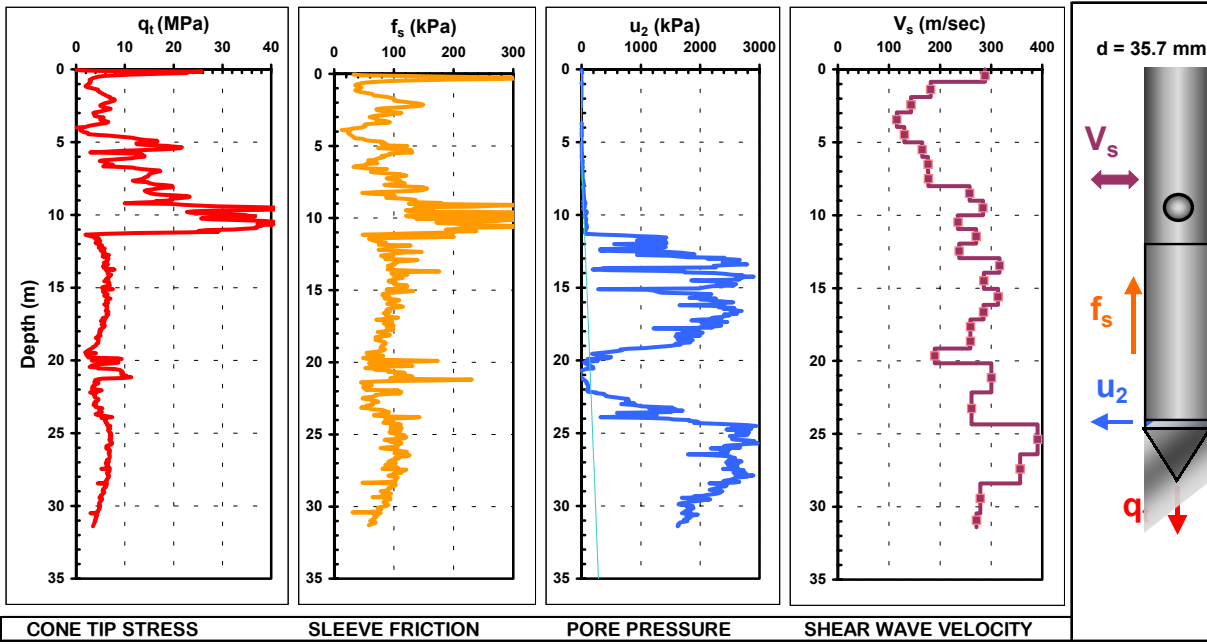


Figure 9-37. Results of Seismic Piezocone Tests (SCPTu) in Layered Soil Profile, Wolf River, Memphis, TN.

The small-strain shear modulus of quartzitic sands may be estimated from the cone tip stress and effective overburden stress, as indicated by Figure 9-35. Similarly, a relationship for obtaining  $G_0$  from DMT in quartz sands is presented in Figure 9-36.

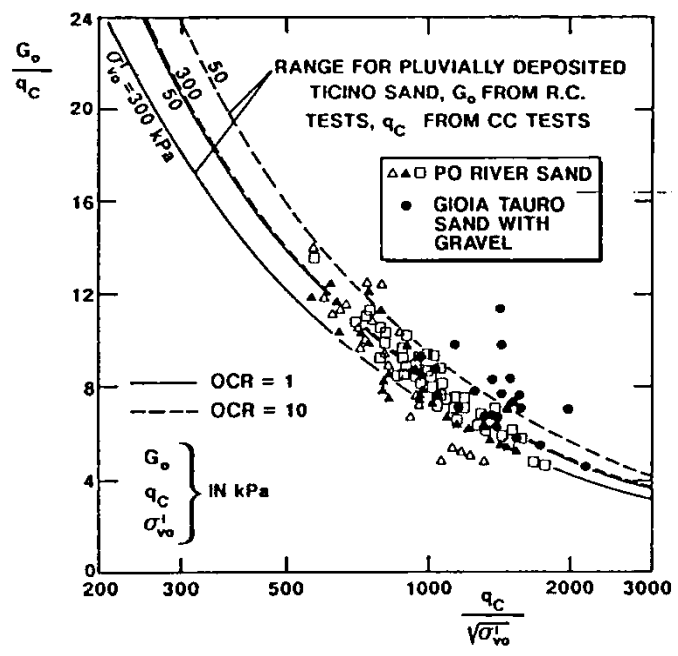


Figure 9-38. Ratio of  $G_0/q_c$  with Normalized CPT Resistance for Uncemented Sands (Baldi, et al. 1989).

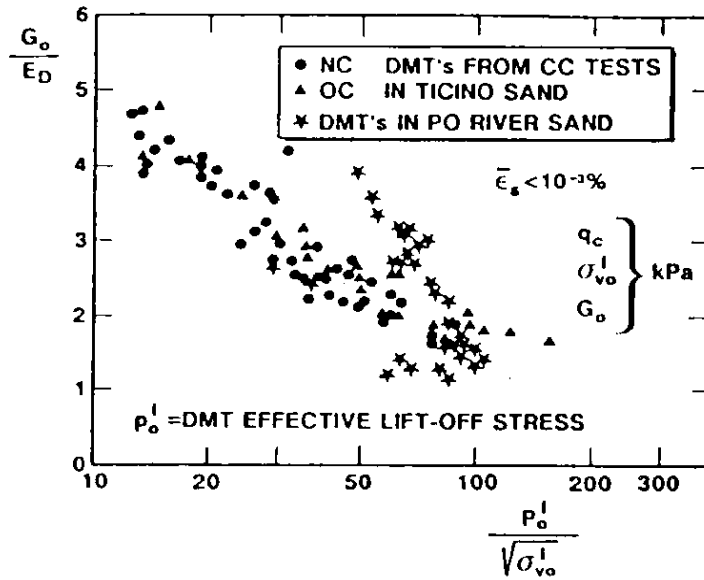


Figure 9-39. Ratio of  $G_0/E_D$  with Normalized DMT Reading for Clean Quartz Sands (Baldi, et al. 1989).

For clays, a relationship between  $G_0$  and corrected tip stress  $q_T$  has been noted (Figure 9-37) which also depends upon the in-place void ratio ( $e_0$ ). Similarly, for the DMT in clays, a trend occurs between  $G_0$  and dilatometer modulus,  $E_D$  (Figure 9-38).

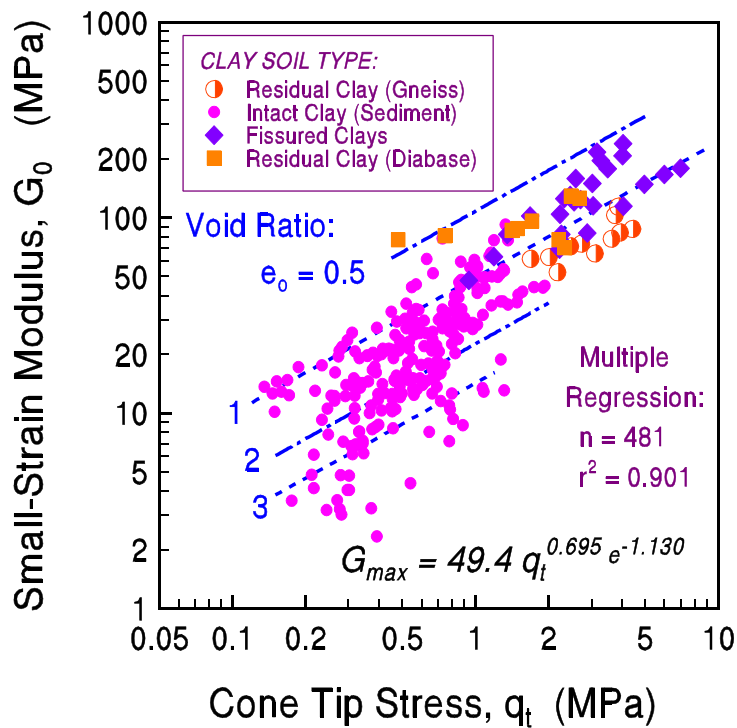


Figure 9-40. Trend Between  $G_0$  and CPT Tip Stress  $q_T$  in Clay Soils (Mayne & Rix, 1993).

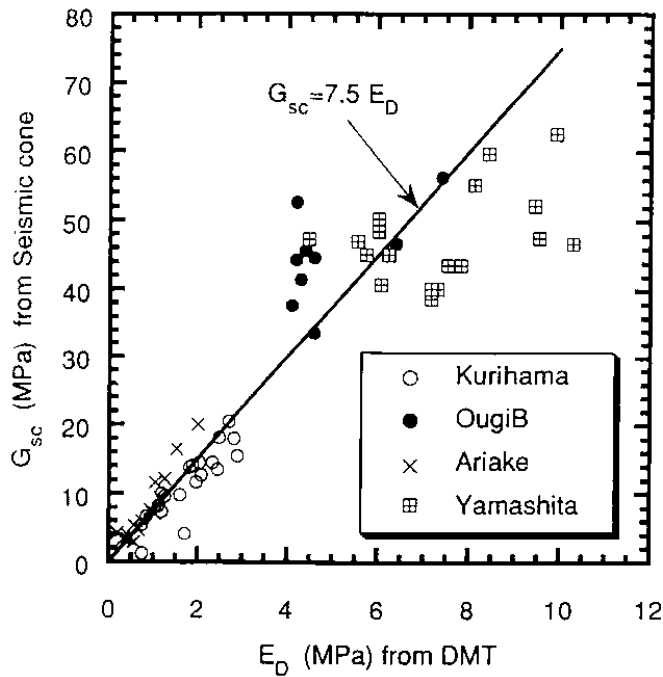


Figure 9-41. Trend Between  $G_0$  and DMT modulus  $E_D$  in Clay Soils (Tanaka & Tanaka, 1998).

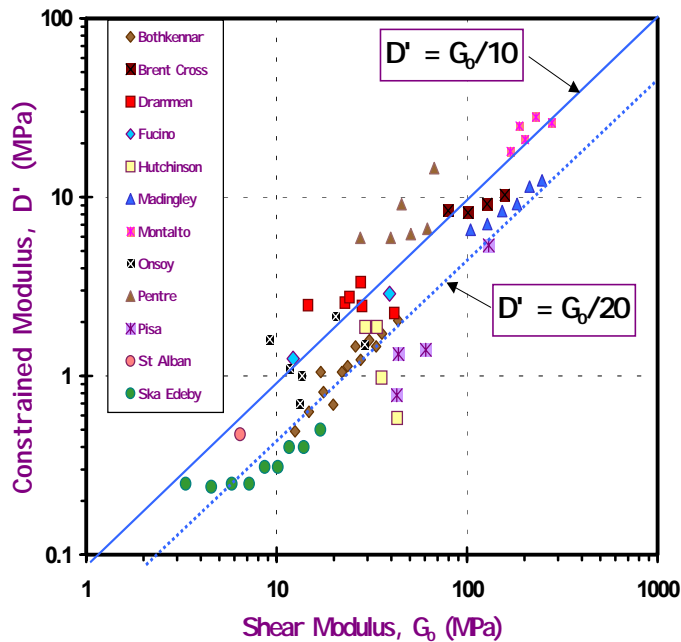


Figure 9-42. Modulus ( $D'$ ) vs. Shear Modulus ( $G_0$ ) in Clays. Dataset from Burns & Mayne (1998).

In each case, the value of initial shear modulus ( $G_0$ ) is either directly measured or approximately assessed, and then reduced to the appropriate level of strain or stress by consideration of the relative factor of safety (FS). An alternative would be to directly relate the constrained modulus to the fundamental  $G_0$ , such as shown in Figure 9-39 for a wide variety of clays. In these data, all  $G_0$  values were obtained from field measurements using either downhole methods (DHT or SCPTu) or crosshole tests (CHT), or in one case, spectral analysis of surface waves (SASW).

## 9.6. FLOW PROPERTIES

Soils exhibit flow properties that control hydraulic conductivity ( $k$ ), rates of consolidation, construction behavior, and drainage characteristics in the ground. Field measurements for soil permeability have been discussed previously in Chapter 6 and include pumping tests with measured drawdown, slug tests, and packer methods. Laboratory methods are presented in Chapter 7 and include falling head and constant head types in permeameters. An indirect assessment of permeability can be made from consolidation test data. Typical permeability values for a range of different soil types are provided in Table 9-1. Results of pressure dissipation readings from piezocone and flat dilatometer and holding tests during pressuremeter testing can be used to determine permeability and the coefficient of consolidation (Jamiolkowski, et al. 1985). Herein, only the piezocone approach will be discussed.

The permeability ( $k$ ) can be determined from the dissipation test data, either by use of the direct correlative relationship presented earlier (Figure 6-7), or alternatively by the evaluation of the coefficient of consolidation  $c_h$ . Assuming radial flow, the horizontal permeability ( $k_h$ ) is obtained from:

$$k_h = \frac{c_h \gamma_w}{D'} \quad (9-30)$$

where  $D'$  = constrained modulus obtained from oedometer tests.

### 9.6.1. Monotonic Dissipation

In fine-grained soils, excess porewater pressures ( $u$ ) are generated during penetration of any probe (pile, cone, blade). For example, in Figure 9-34, large  $u_2$  readings are observed in the clay layer from 11 to 19 m depth. If penetration is halted, the  $u$  will decay eventually to zero (thus the porewater transducer will read the hydrostatic value,  $u_0$ ). The rate of decay depends on the coefficient of (horizontal) consolidation ( $c_h$ ) and permeability ( $k_h$ ) of the medium. An example of piezocone dissipation for both type 1 and 2 filter elements is given in Figure 6-6. These are termed *monotonic* porewater decays because the readings always decrease with time and generally are associated with soft to firm clays and silts. For these cases, the strain path method (Teh & Houlsby, 1991) may be used to determine  $c_h$  from the expression:

$$c_h = \frac{T^* a^2 \sqrt{I_R}}{t_{50}} \quad (9-31)$$

where  $T^*$  = modified time factor from consolidation theory,  $a$  = probe radius,  $I_R = G/s_u$  = rigidity index of the soil, and  $t$  = measured time on the dissipation record (usually taken at 50% equalization).

Several solutions have been presented for the modified time factor  $T^*$  based on different theories, including cavity expansion, strain path, and dislocation points (Burns & Mayne, 1998). For monotonic dissipation response, the strain path solutions (Teh & Houlsby, 1991) are presented in Figure 9-40(a) and (b) for both midface and shoulder type elements, respectively.

The determination of  $t_{50}$  from shoulder porewater decays is illustrated by example in Figure 6-6. For the particular case of 50% consolidation, the respective time factors are  $T^* = 0.118$  for the type 1 (midface element) and  $T^* = 0.245$  for the type 2 (shoulder element).



**TABLE 9-1.**

**REPRESENTATIVE PERMEABILITY VALUES FOR SOILS**

(Modified after Carter and Bentley, 1991)

	10 <sup>-11</sup>	10 <sup>-10</sup>	10 <sup>-9</sup>	10 <sup>-8</sup>	10 <sup>-7</sup>	10 <sup>-6</sup>	10 <sup>-5</sup>	10 <sup>-4</sup>	10 <sup>-3</sup>	10 <sup>-2</sup>	10 <sup>-1</sup>	1
k =	↓	↓	↓	↓	↓	↓	↓	↓	↓	↓	↓	↓
<i>Hydraulic Conductivity</i>		<b>meters/sec (m/s)</b>										
or	10 <sup>-9</sup>	10 <sup>-8</sup>	10 <sup>-7</sup>	10 <sup>-6</sup>	10 <sup>-5</sup>	10 <sup>-4</sup>	10 <sup>-3</sup>	10 <sup>-2</sup>	10 <sup>-1</sup>	1	10	100
<i>Coefficient of Permeability</i>	↓	↓	↓	↓	↓	↓	↓	↓	↓	↓	↓	↓
	<b>centimeters/sec (cm/s)</b>											
Permeability:	Practically Impermeable		Very low		Low		Medium		High			
Drainage conditions:	Practically Impermeable		Poor		Fair		Good					
Typical soil Groups*:	GC → GM →		SM		SW →		GW →					
	CH SC		SM-SC MH ML-CL		SP →		GP →					
Soil types:	Homogeneous clays below the zone of weathering		Silts, fine sands, silty sands, glacial till, stratified clays				Clean sands, sand and gravel mixtures			Clean gravels		
			Fissured and weathered clays and clays modified by the effects of vegetation									

\*Note: The arrow adjacent to group classes indicates that permeability values can be greater than the typical value shown.

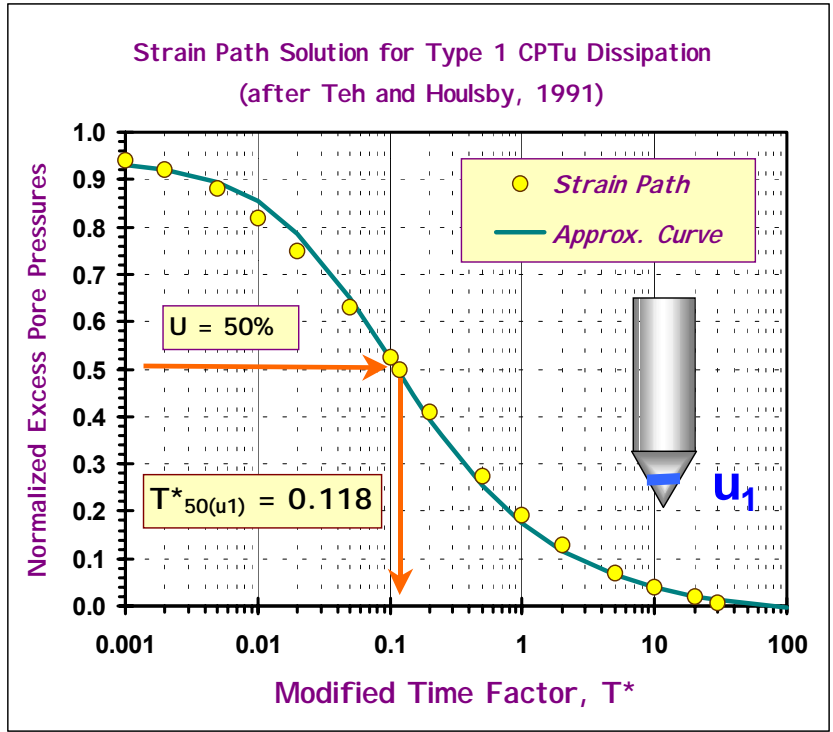


Figure 9-43a. Modified Time Factors for  $u_1$  Monotonic Porewater Dissipations

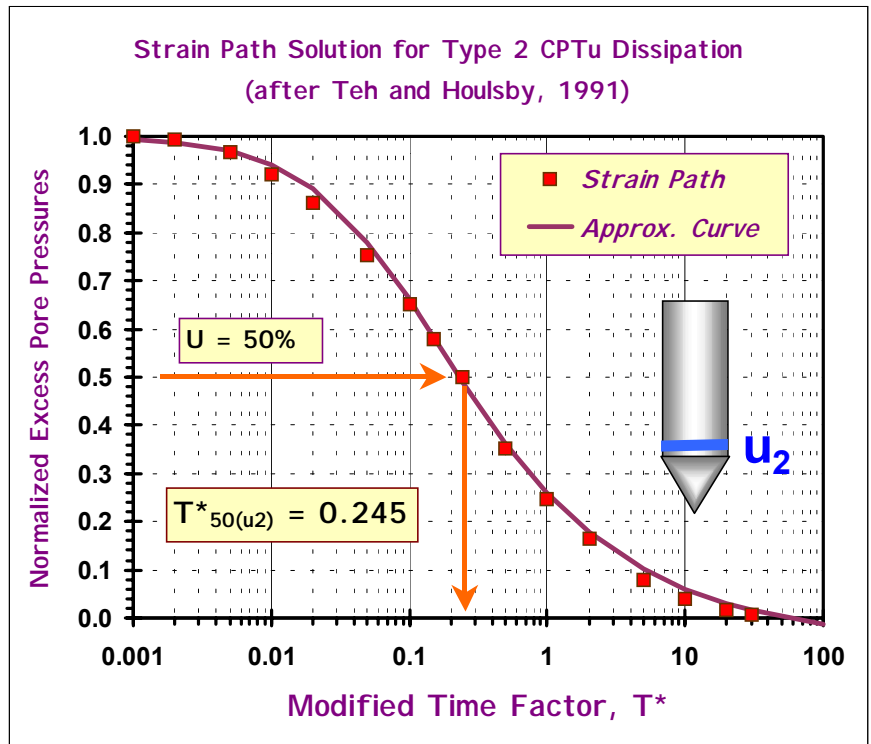


Figure 9-43b. Modified Time Factors for  $u_2$  Monotonic Porewater Dissipations

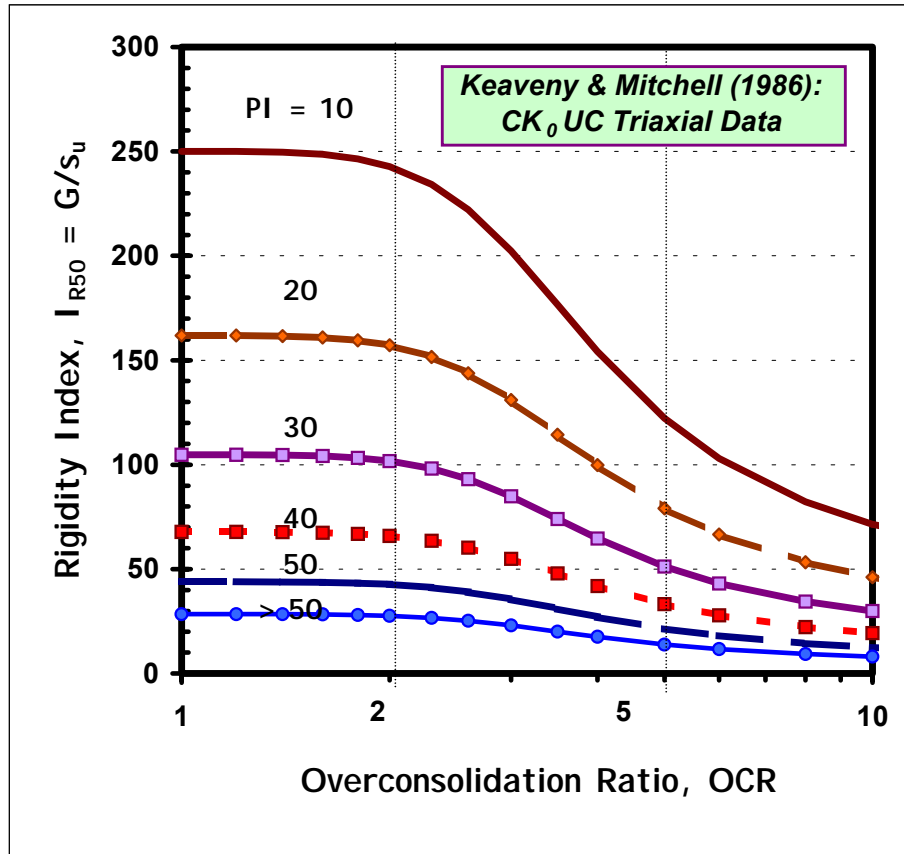


Figure 9-44. Estimation of Rigidity Index from OCR and Plasticity Index (Keaveny & Mitchell, 1986).

For clays, the rigidity index ( $I_R$ ) is the ratio of shear modulus ( $G$ ) to shear strength ( $s_u$ ) and may be obtained from a number of different means including: (a) measured triaxial stress-strain curve, (b) measured pressuremeter tests, and (c) empirical correlation. One correlation based on anisotropically-consolidated triaxial compression test data expresses  $I_R$  in terms of OCR and plasticity index (PI), as shown in Figure 9-41. For spreadsheet use, the empirical trend may be approximated by:

$$I_R \approx \frac{\exp\left[\frac{137 - PI}{23}\right]}{\left[1 + \ln\left\{1 + \frac{(OCR - 1)^{3.2}}{26}\right\}\right]^{0.8}} \quad (9-30)$$

Additional approaches to estimating the value of  $I_R$  are reviewed elsewhere (Mayne, 2001).

To facilitate the interpretation of  $c_h$  corresponding to  $t_{50}$  readings using the standard penetrometer, Figure 9-42 presents a graphical plot for various  $I_R$  values.

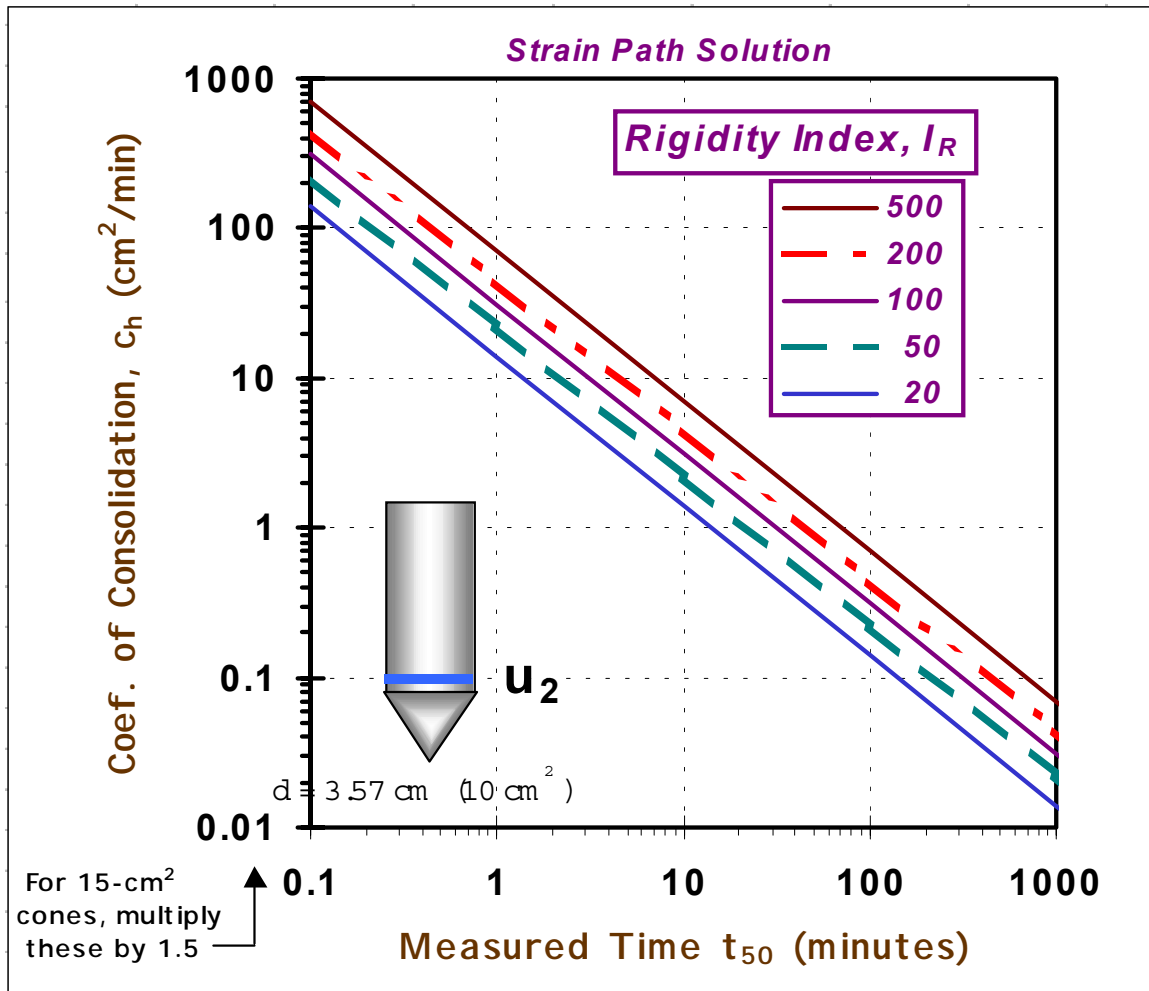


Figure 9-45. Coefficient of Consolidation for 50% Dissipation from Shoulder Readings

### 9.6.2. Dilatory Dissipations

In many overconsolidated and fissured materials, a dissipation test may first show an increase in  $u$  with time, reaching a peak value, and subsequent decrease in  $u$  with time (e.g., Lunne, et al. 1997). This type of response is termed *dilatory* dissipation, referring to both the delay in time and cause of the phenomenon (dilation). The dilatory response has been observed during type 2 piezocone tests as well as during installation of driven piles in fine-grained soils. The definition of 50% completion is not clear and thus the previous approach is not applicable.

A rigorous mathematics derivation has been presented elsewhere that provides a cavity expansion-critical state solution to both monotonic and dilatory porewater decay with time (Burns & Mayne, 1998). For practical use, an approximate closed-form expression is presented here. In lieu of merely matching one point on the dissipation curve (i.e.,  $t_{50}$ ), the entire curve is matched to provide the best overall value of  $c_h$ . The excess porewater pressures  $u_t$  at any time  $t$  can be compared with the initial values during penetration ( $u_i$ ).

The measured initial excess porewater pressure ( $u_i = u_2 - u_0$ ) is given by:

$$u_i = u_{oct,i} + u_{shear,i} \quad (9-31)$$

where  $u_{oct,i} = F_{vo} r (2M/3) (OCR/2)^7 \ln(I_R)$  = the octahedral component during penetration;

and  $u_{shear,i} = F_{vo} r [1 - (OCR/2)^7]$  is the shear-induced component during penetration.

The porewater pressures at **any** time (t) are obtained in terms of the modified time factor  $T^*$  from:

$$u_t = u_{oct,i} [1 + 50 Tr]^{-1} + u_{shear,i} [1 + 5000 Tr]^{-1} \quad (9-32)$$

where a different modified time factor is defined by:  $Tr = (c_h t)/(a^2 I_R^{0.75})$ . On a spreadsheet, a column of assumed (logarithmic) values of  $Tr$  are used to generate the corresponding time (t) for a given rigidity index ( $I_R$ ) and probe radius (a). Then, trial & error can be used to obtain the best fit  $c_h$  for the measured dissipation data. Series of dissipation curves can be developed for a given set of soil properties. One example set of curves is presented in Figure 9-43 for various OCRs and the following parameters:  $\Lambda = 0.8$ ,  $I_R = 50$ , and  $Nr = 25^\circ$ , in order to obtain the more conventional time factor,  $T = (c_h t)/a^2$ .

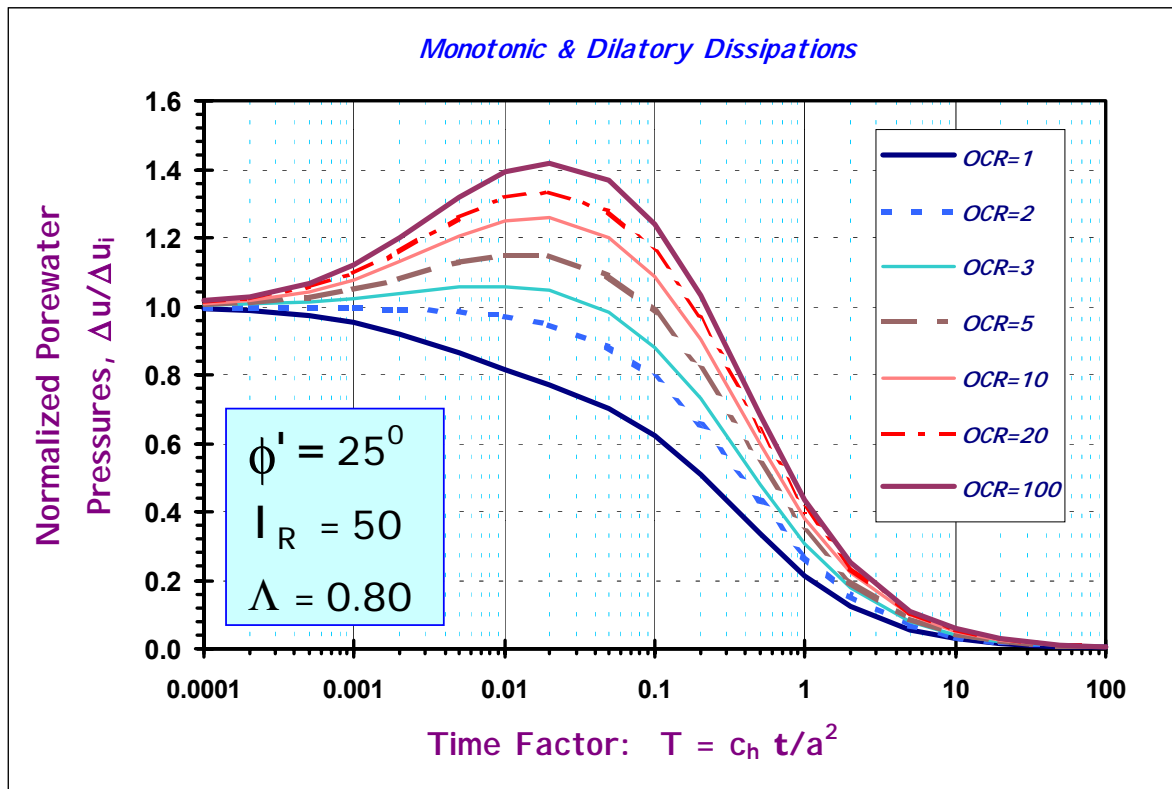


Figure 9-46 Representative Solutions for Type 2 Dilatory Dissipation Curves at Various OCRs (after Burns & Mayne, 1998).

## 9.7 NONTEXTBOOK MATERIALS

The aforementioned relationships have been developed for “common” geomaterials, including clays and silts of low to medium sensitivity and uncemented quartz sands. The geotechnical engineer should always be on the lookout for unusual soils and complex natural materials, as Mother Earth has bestowed a vast and varied assortment of soil particles under many different geologies and origins. In many parts of the world, notoriety is associated with highly organic soils such as peats, bogs, muskegs, and organic clays & silts. In some settings, sensitive soils and quick clays may be found. These soils should be approached with great caution and concern over their short- and long-term behavior with respect to strength, stiffness, and creep characteristics.

In certain locations, cemented sands of calcareous origin or corraline deposits (carbonate sands) are found and these exhibit significantly different behavior to loading than the more ubiquitous quartz sands. Other nontextbook soil types include diatomaceous earth, dispersive clays, collapsible soils, loess, volcanic ash, and special structured geomaterials. When in doubt, additional testing and outside consultants should be brought in to assist in the evaluation of the subsurface conditions and interpretation of soil properties. Although these may seem like extra expenses from an initial viewpoint, in the unfortunate scenario of a poorly-designed facility, the overall immense costs associated with the remediation, repair, failure, and/or ensuing litigation will far outweigh the small investigative costs up-front.

Finally, man-made geomaterials have emerged in the past century, bringing many new and interesting challenges to geotechnique. These include vast amounts of tailings derived from mining operations related to extraction of copper, gold, uranium, phosphates, smectites, and bauxite. These tailings disposals include earthen dams that impound slimes that are unconsolidated, thus requiring periodic checks on stability of slopes under static and dynamic loading. Other man-made geomaterials include modified ground from site improvement works such as vibroflotation, dynamic compaction, and grouting. Artificial "soils" include the very large deposits of waste (or "urban fill") and construction of immense landfills across the U.S. These, in particular, offer new demands for site characterization technologies because of the unusual and widely-diverse nature of these landfilled substances.

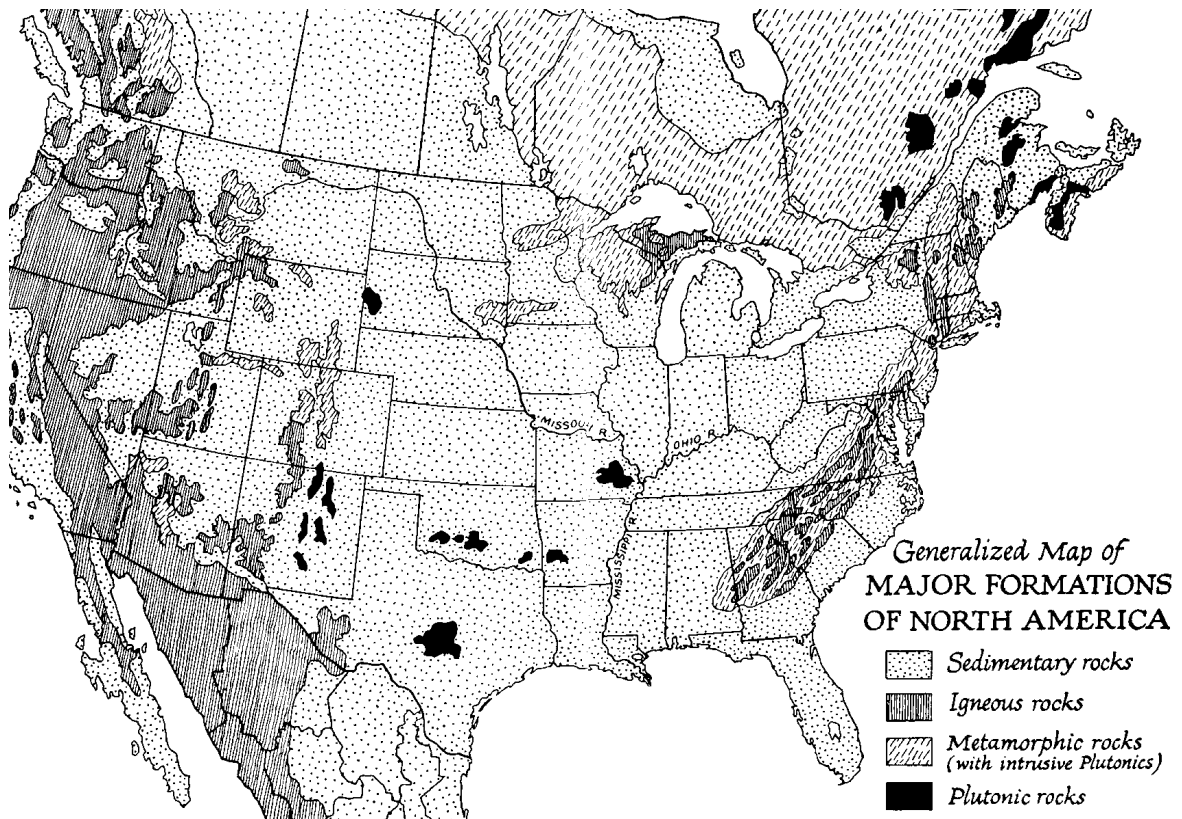
## CHAPTER 10

### INTERPRETATION OF ROCK PROPERTIES

#### 10.1. INTRODUCTION

The engineering behavior of most rock masses under loading is determined primarily by the discontinuities, fractures, joints, fissures, cracks, and planes of weakness. The intact blocks of rock between the discontinuities are usually sufficiently strong, except in the case of weak & porous rocks and those that weather rapidly. Thus, two classification systems are needed to adequately characterize these geomaterials: one for the intact solid rock and another for the rock mass. The network of fractures divide the rock mass into discrete and prismatic blocks that affect its response and performance. With the exception of the durability testing (discussed in Chapter 8), the results of laboratory testing are of limited direct applicability to design of structures founded in or on rock masses.

Of the three primary rock types (igneous, metamorphic and sedimentary), sedimentary rocks comprise 75% of the rocks exposed at the ground surface. Among the sedimentary rocks, the rocks of the shale family (clay shale, siltstone, mudstone, and claystone) predominate, representing over 50% of the exposed sedimentary rocks worldwide (Foster, 1975). The distribution of rock types within the U.S.A. is reviewed by Witczak (1972) and Figure 10-1 shows a simplified map of their occurrence (Pough, 1988).



**Figure 10-1. Generalized Distribution of Sedimentary, Igneous, & Metamorphic Rocks in the U.S.A**  
(From Pough, 1988)

An initial step during site reconnaissance and exploration is to categorize the basic type of rock, per Table 10-1. Detailed geological classifications of rock types and petrographic examinations in the laboratory will be required for major projects involving construction on rocks. Field mapping by engineering geologists is necessary for description of the jointing patterns, major discontinuity sets, shear zones, and faults, particularly in areas involving rock slopes, cliffs, tunnels, and bridge abutments. A detailed discussion of these aspects may be found elsewhere (e.g., Goodman, 1989; Pough, 1988). Major slip planes and joints should be detailed on maps with appropriate values of dip angle and dip direction (or alternatively, strike). Large groups of discontinuities are best represented by statistical summaries on stereonet and polar diagrams. Important shear zones and faults can also be depicted on these plots.

**TABLE 10-1.**

**PRIMARY ROCK TYPES CLASSIFIED BY GEOLOGIC ORIGIN**

<b>Grains Aspects</b>	<b>Sedimentary Types</b>		<b>Metamorphic Types</b>		<b>Igneous Types</b>	
	<b>Clastic</b>	<b>Carbonate</b>	<b>Foliated</b>	<b>Massive</b>	<b>Intrusive</b>	<b>Extrusive</b>
<b>Coarse</b>	<b><i>Conglomerate Breccia</i></b>	<b><i>Limestone Conglomerate</i></b>	<b><i>Gneiss</i></b>	<b><i>Marble</i></b>	<b><i>Pegmatite Granite</i></b>	<b><i>Volcanic Breccia</i></b>
<b>Medium</b>	<b><i>Sandstone Siltstone</i></b>	<b><i>Limestone Chalk</i></b>	<b><i>Schist Phyllite</i></b>	<b><i>Quartzite</i></b>	<b><i>Diorite Diabase</i></b>	<b><i>Tuff</i></b>
<b>Fine</b>	<b><i>Shale Mudstone</i></b>	<b><i>Calcareous Mudstone</i></b>	<b><i>Slate</i></b>	<b><i>Amphibolite</i></b>	<b><i>Rhyolite</i></b>	<b><i>Basalt Obsidian</i></b>

Alternate classification systems are proposed based on behavioral aspects (Goodman, 1989) or composition and texture (Wyllie, 1999). Details on the specific rock minerals and their relative abundance is important in the petrographic determination of the rock types, yet beyond the scope of discussion here. In the logging of field mapping and rock coring operations, the specific formation name and age of the rock is often noted, being helpful in sorting stratigraphic layering and the determination of the subsurface profile. Table 10-2 gives the general geologic time scale and associated periods. Generally, older rocks have lower porosity and higher strength than younger rocks (Goodman, 1989).

Rock type can often infer possible problems that can be encountered in construction. Notable problems occur in limestone (sinkholes, caves), serpentine (slippage), bentonitic shales (swelling, slope stability), and diabase (boulders). Deterioration of shale family of rocks and weakly-cemented friable sandstones is the cause of many of the maintenance problems in the national highway system, particularly with respect to cuts, embankment construction, and foundations. For example, deterioration of cut slopes in shales will result in flatter slopes and/or instability. Shale used in embankments when compacted will break down and result in a material less pervious than anticipated for a rock fill. Maintenance problems for slopes can be mitigated by making them flatter, installation of horizontal drains, use of gunite & mesh, or in some cases, more elaborate structural supports are required (rock bolts, retention walls, anchors, drilled shafts). When excavation for a structural foundation is made, the bearing level must be protected against slaking and/or expansion; this can be accomplished by spraying a protective coating on the freshly exposed rock surface, such as gunite or shotcrete. Additional details and considerations are given in Wyllie (1999).



**TABLE 10-2.**  
**GEOLOGIC TIME SCALE**

<i>Era</i>	<i>Period</i>	<i>Epoch</i>	<i>Time Boundaries (Years Ago)</i>
Cenozoic	Quaternary	Holocene - Recent	10,000
		Pleistocene	2 million
	Tertiary	Pliocene	5 million
		Miocene	26 million
		Oligocene	38 million
		Eocene	54 million
		Paleocene	65 million
		Cretaceous	130 million
Mesozoic	Jurassic	185 million	
	Triassic	230 million	
	Permian	265 million	
	Paleozoic	Carboniferous	Pennsylvanian
Mississippian			355 million
Devonian		413 million	
Silurian		425 million	
Ordovician		475 million	
Cambrian		570 million	
Precambrian (oldest rocks)			3.9 billion
Earth Beginning			4.7 billion

The design of rock structures is still frequently done on the basis of an empirical evaluation of rock mass properties guided by experience, consideration of rock mass structure, index properties and correlations, and other parameters, such as joint spacing, roughness, degree of weathering, dip & dip direction of slip planes, infilling, extent of discontinuities, and groundwater conditions (see Figure 10-2). Many of these facets can be grouped together to give an overall rating of the predominant factors affecting the performance of the entire rock mass under loading. Thus, a rating of the rock mass will be described using three common methods (RMR = rock mass rating; Q system, and GSI = geologic strength index).

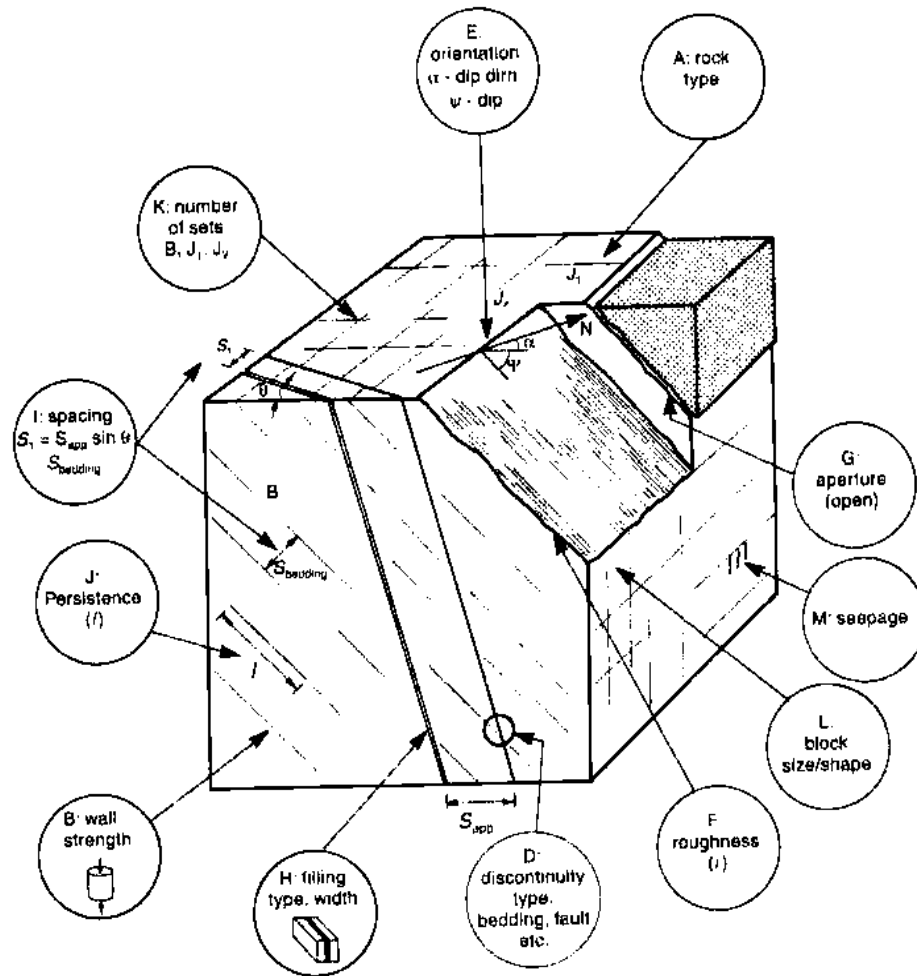


Figure 10-2. Factors & Parameters Affecting Geologic Mapping of Rock Mass Features (Wyllie, 1999).

As in the case of the evaluation of soil properties, a number of correlations have been developed for the interpretation of rock properties. Notably, however, the rock property correlations reported in the technical literature often have a limited database and should be used with caution. An attempt should be made to develop correlations applicable to the specific rock formations in a particular state, as this can be well worth the expenditure of time and effort in terms of overall safety and economy.

This chapter presents general discussions on the properties of intact rock and jointed rock masses, particularly using rock mass classification schemes and their relevance to the design of rock structures. The reader is strongly encouraged to refer to the original references to understand the basis of the correlations and the classification systems presented in this chapter and for additional information.

## 10.2 INTACT ROCK PROPERTIES

This section presents information on the indices and properties of natural intact rock. The values are obtained from tests conducted in the laboratory on small specimens of rock and therefore must be adjusted to full scale conditions in order to represent the overall rock mass conditions.

### 10.2.1 Specific Gravity

The specific gravity of solids ( $G_s$ ) of different rock types depends upon the minerals present and their relative percentage of composition. The values of  $G_s$  for selected minerals are presented in Figure 10-3. Very common minerals include quartz and feldspar, as well as calcite, chlorite, mica, and the clay mineral group (illite, kaolinite, smectite). The bulk value of these together gives an representative average value of  $G_s = 2.7 \pm 0.1$  for many rock types.

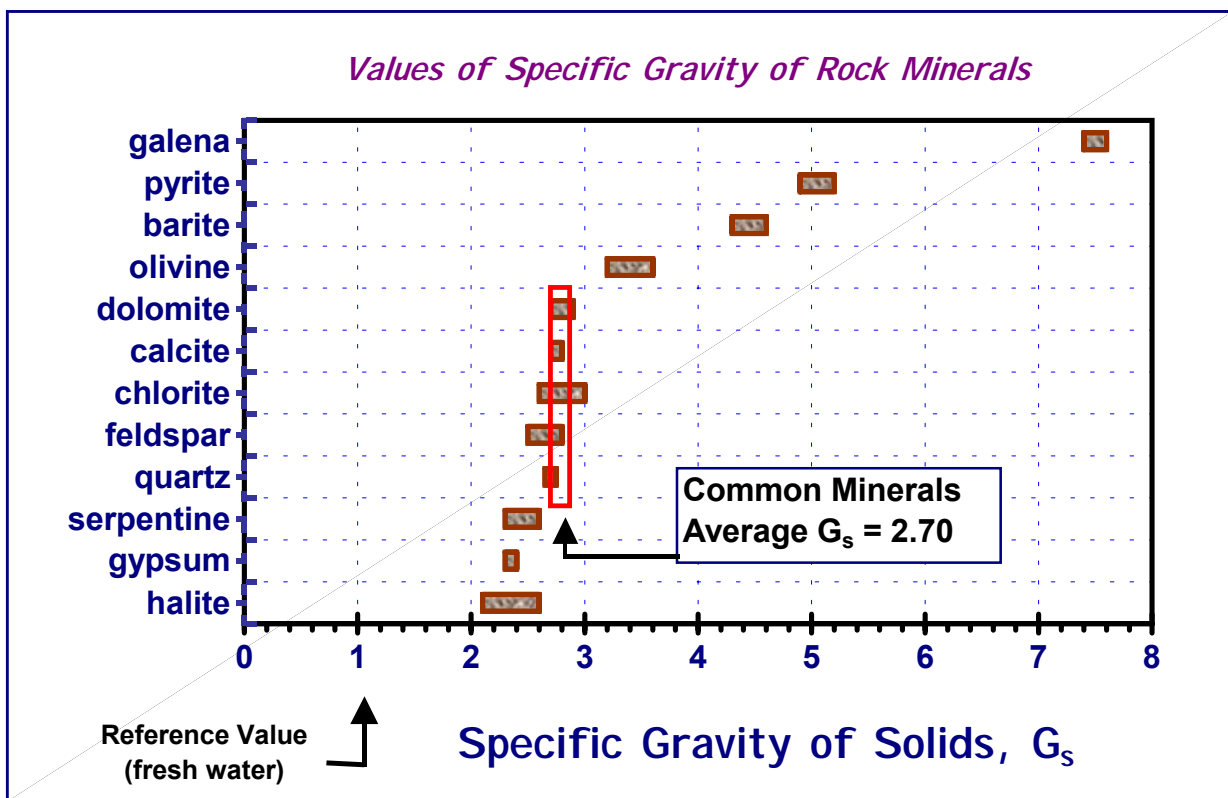


Figure 10-3. Specific Gravity of Solids for Selected Rock Minerals.

### 10.2.2. Unit Weight

The unit weight of rock is needed in calculating overburden stress profiles in problems involving rock slopes and tunnel design support systems. Also, because the specific gravity of the basic rock-forming minerals exhibits a narrow range, the unit weight is an indicator of the degree of induration of the rock unit and is thus an indirect indicator of rock strength. Strength of the intact rock material tends to increase proportionally to the increase in unit weight. Representative dry unit weights for different rock types are contained in Table 10-3.

TABLE 10-3

REPRESENTATIVE RANGE OF DRY UNIT WEIGHTS

Rock Type	Unit Weight Range (kN/m <sup>3</sup> )
Shale	20 - 25
Sandstone	18 - 26
Limestone	19 - 27
Schist	23 - 28
Gneiss	23 - 29
Granite	25 - 29
Basalt	20 - 30

1. Dry unit weights are for moderately weathered to unweathered rock.. Note: 9.81 kN/m<sup>3</sup> = 62.4 pcf.
2. Wide range in unit weights for shale, sandstone, and limestone represents effect of variations in porosity, cementation, grain size, depth, and age.
3. Specimens with unit weights falling outside the ranges contained herein may be encountered.

The dry unit weight ( $\gamma_{dry}$ ) is calculated from the bulk specific gravity of solids and porosity (n) according to:

$$\gamma_{dry} = \gamma_{water} G_s (1 - n) \quad (10-1)$$

Where the unit weight of water is ( $\gamma_{water} = 9.81 \text{ kN/m}^3 = 62.43 \text{ pcf}$ ). The saturated unit weight ( $\gamma_{sat}$ ) of rocks can be expressed:

$$\gamma_{sat} = \gamma_{water} [G_s (1 - n) + n] \quad (10-2)$$

These expressions are consistent with those in Table 7-2 for soil materials where void ratio is used more commonly. The interrelationship between porosity and void ratio (e) is simply:  $n = e/(1+e)$ . The decrease in saturated unit weight with increasing porosity is presented in Figure 10-4 for various rocks and a selected range of specific gravity values.

**10.2.3. Ultrasonic Velocities**

The compression and shear wave velocities of rock specimens can be measured in the laboratory using ultrasonics techniques (see Section 8, Figure 8-7). These wave values can be used as indicators of the degree of weathering and soundness of the rock, as well as compared with in-situ field measurements that relate to the extent of fissuring and discontinuities of the larger rock mass. The summary of data in Figure 10-5 illustrates the general ranges of compression wave ( $V_p$ ) between 3000 and 7000 m/s and ranges of shear waves ( $V_s$ ) between 2000 and 3500 m/s for intact rocks.

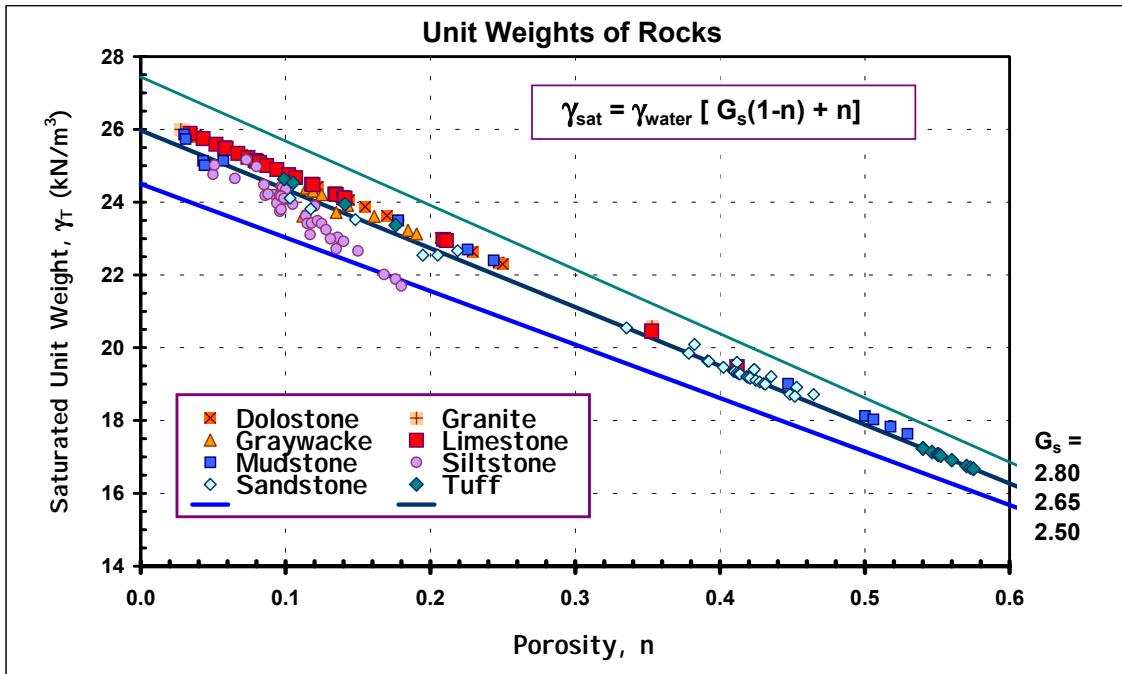


Figure 10-4. Saturated Rock Unit Weight in Terms of Porosity and Specific Gravity.

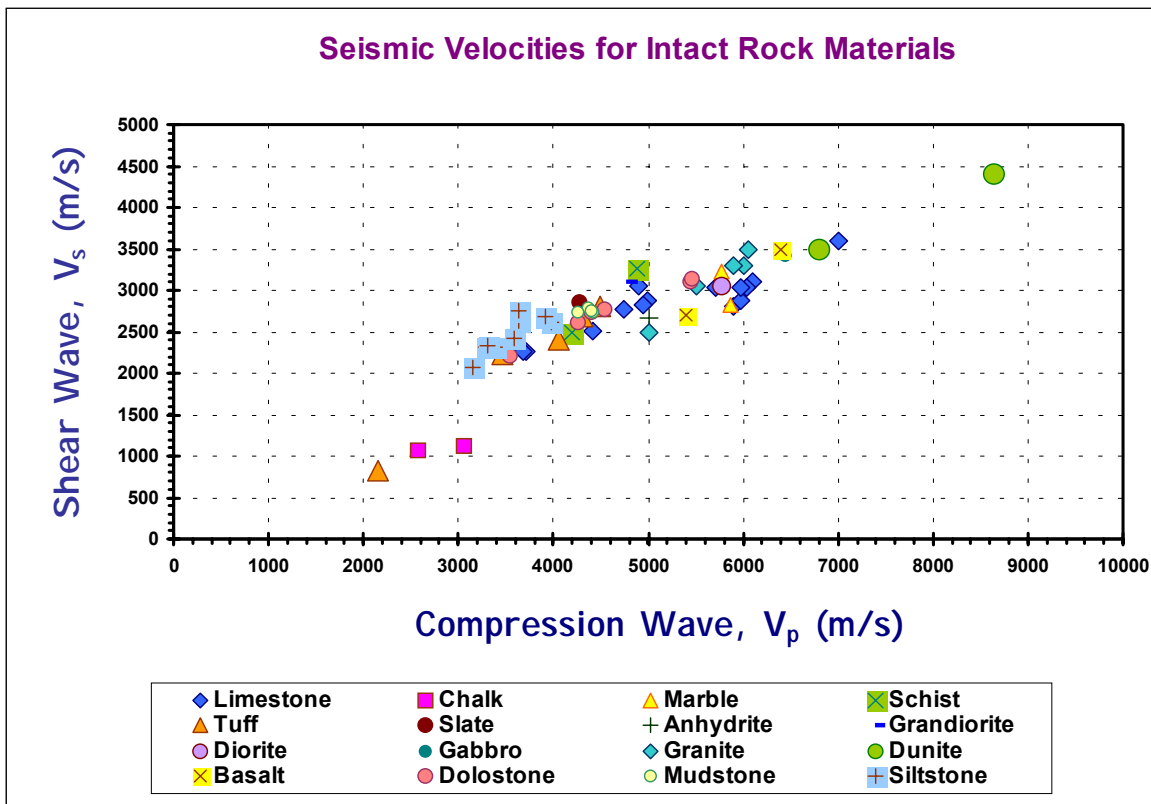


Figure 10-5. Representative S- and P-wave Velocities for Intact Rock Materials.

## 10.2.4 Compressive Strength

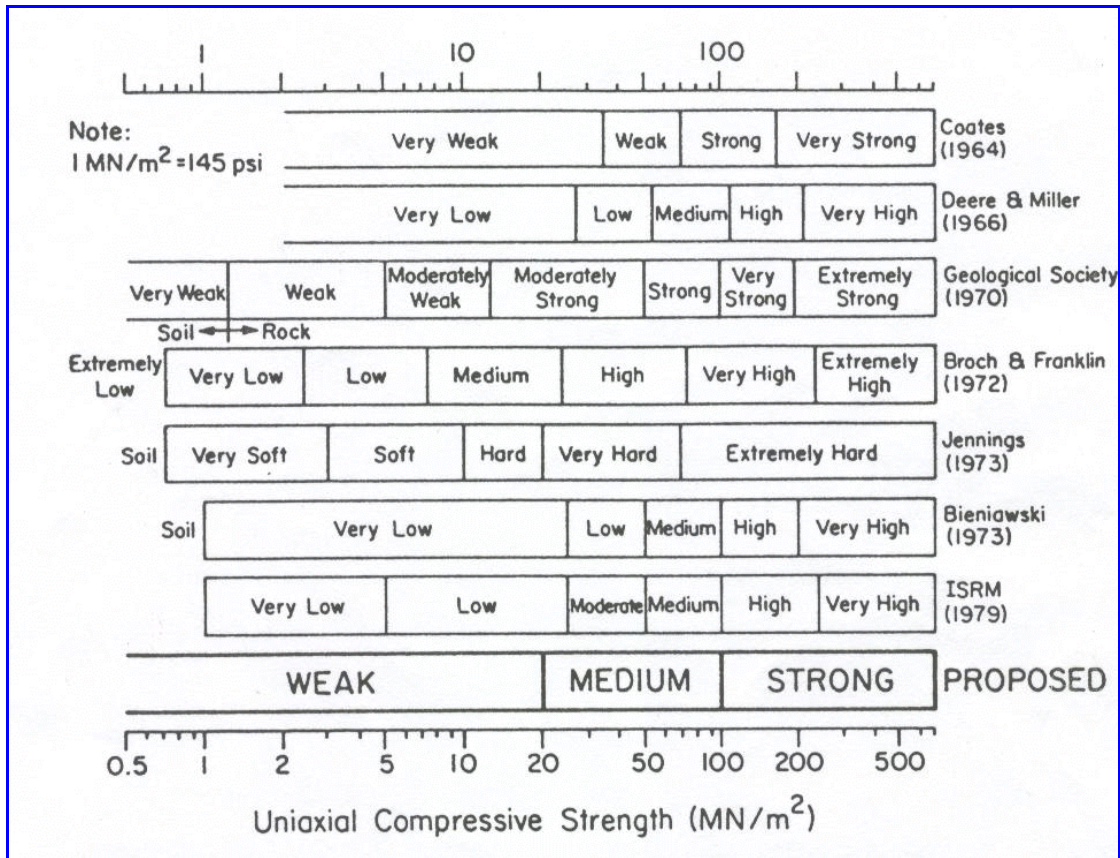
The stress-strain-strength behavior of intact rock specimens can be measured during a uniaxial compression test (unconfined compression), or the more elaborate triaxial test (See details in Figures 8-2 and 8-6). The peak stress of the  $F_s$  curve during unconfined loading is the uniaxial compressive strength (designated  $q_u$  or  $F_u$ ). The value of  $q_u$  can be estimated from the point load index ( $I_s$ ) that is easily conducted in the field (see Figure 8-1). Representative values of compressive strengths for a variety of intact rock specimens are listed in Table 10-4 (Goodman, 1989). For this database, the compressive strengths ranged from 11 to 355 MPa (1.6 to 51.5 ksi), with a mean value of  $q_u = 135$  MPa (19.7 ksi). A wide range in compressive strength can exist for a particular geologic rock type, depending upon porosity, cementation, degree of weathering, formation heterogeneity, grain size angularity, and degree of interlocking of mineral grains. The compressive strength also depends upon the orientation of load application with respect to microstructure (e.g., foliation in metamorphic rocks and bedding planes in sedimentary rocks).

**TABLE 10-4.**  
**REPRESENTATIVE MEASURED PARAMETERS ON INTACT ROCK SPECIMENS**  
(modified after Goodman, 1989)

<b>Intact Rock Material</b>	<b><math>q_u</math> (MPa)</b>	<b><math>T_0</math> (MPa)</b>	<b><math>E_R</math> (MPa)</b>	<b><math>\nu</math> (-)</b>	<b>Ratio <math>q_u/T_0</math></b>	<b>Ratio <math>E_R/q_u</math></b>
<i>Baraboo Quartzite</i>	320.0	11.0	88320	0.11	29.1	276
<i>Bedford Limestone</i>	51.0	1.6	28509	0.29	32.3	559
<i>Berea Sandstone</i>	73.8	1.2	19262	0.38	63.0	261
<i>Cedar City Tonalite</i>	101.5	6.4	19184	0.17	15.9	189
<i>Cherokee Marble</i>	66.9	1.8	55795	0.25	37.4	834
<i>Dworshak Dam Gneiss</i>	162.0	6.9	53622	0.34	23.5	331
<i>Flaming Gorge Shale</i>	35.2	0.2	5526	0.25	167.6	157
<i>Hackensack Siltstone</i>	122.7	3.0	29571	0.22	41.5	241
<i>John Day Basalt</i>	355.0	14.5	83780	0.29	24.5	236
<i>Lockport Dolomite</i>	90.3	3.0	51020	0.34	29.8	565
<i>Micaceous Shale</i>	75.2	2.1	11130	0.29	36.3	148
<i>Navajo Sandstone</i>	214.0	8.1	39162	0.46	26.3	183
<i>Nevada Basalt</i>	148.0	13.1	34928	0.32	11.3	236
<i>Nevada Granite</i>	141.1	11.7	73795	0.22	12.1	523
<i>Nevada Tuff</i>	11.3	1.1	3649.9	0.29	10.0	323
<i>Oneota Dolomite</i>	86.9	4.4	43885	0.34	19.7	505
<i>Palisades Diabase</i>	241.0	11.4	81699	0.28	21.1	339
<i>Pikes Peak Granite</i>	226.0	11.9	70512	0.18	19.0	312
<i>Quartz Mica Schist</i>	55.2	0.5	20700	0.31	100.4	375
<i>Solenhofen Limestone</i>	245.0	4.0	63700	0.29	61.3	260
<i>Taconic Marble</i>	62.0	1.2	47926	0.40	53.0	773
<i>Tavernalle Limestone</i>	97.9	3.9	55803	0.30	25.0	570

<b>Statistical Results:</b>	Mean =	135.5	5.6	44613	0.29	39.1	372.5
	S.Dev. =	93.7	4.7	25716	0.08	35.6	193.8

Note: 1 MPa = 10.45 tsf = 145.1 psi



**Figure 10-6. Classifications for Unweathered Intact Rock Material Strength**  
(Kulhawy, Trautmann, and O'Rourke, 1991)

The compressive strength serves as an initial index on the competency of intact rock. Figure 10-6 shows a comparison of several classification schemes. This is particularly useful for defining differences between hard clays to shales, as the boundary in the transition from soil to rock is not precise in these sedimentary materials. Similarly, it is applicable to residual profiles where the transition from soil to saprolite and weathered rock and rock may be needed. It can become important in contracts involving excavatability issues of rock vs. soil, as the former is considerably more expensive than the latter during site grading, deep excavations, and foundation construction.

### 10.2.5 Direct and Indirect Tensile Strength

Rock is relatively weak in tension, and thus, the tensile strength ( $T_0$ ) of an intact rock is considerably less than its compressive value ( $q_u$ ). Their interrelation in terms of Mohr strength criterion is shown in Figure 10-7. The direct tensile strength on rock specimens is not a common laboratory procedure because of the difficulties involved in proper end preparation (Jaeger and Cook, 1977). Therefore, it is usual to evaluate the tensile strength through indirect methods, including the split-tensile test (Brazilian test, per Figure 8-3), or alternatively, a bending test to obtain the modulus of rupture.

A list of representative tensile strength values for various rocks is given in Table 10-4 with a measured range from 0.2 to 14 MPa (30 to 2100 psi) and mean value  $T_0 = 5.6$  MPa (812 psi). For the data considered, it can be seen from Figure 10-8 that the tensile strength averages only about 4% of the compressive strength for the same rock.

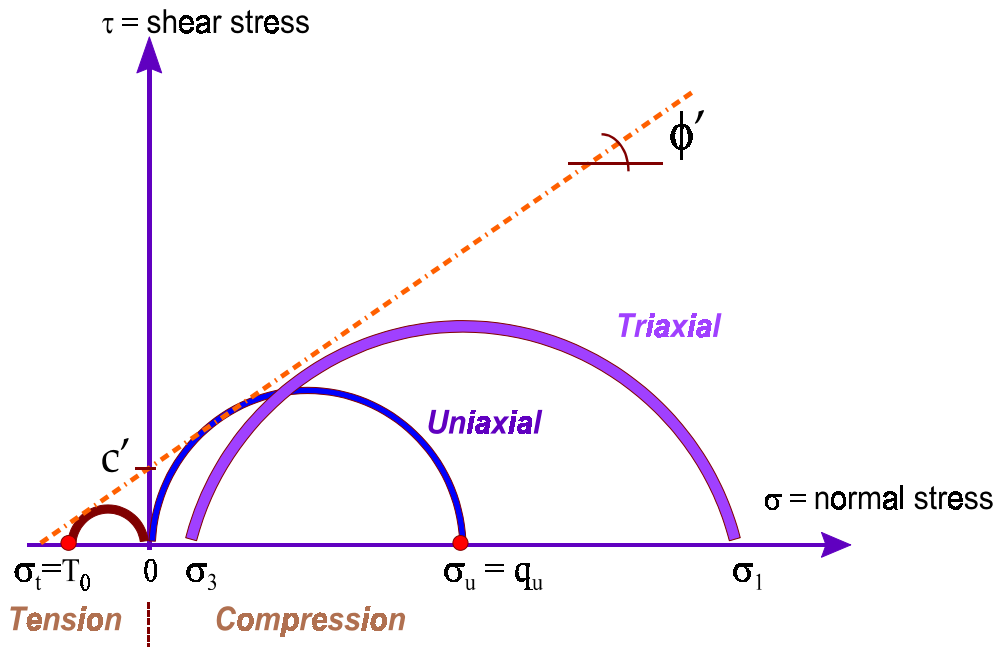


Figure 10-7. Interrelationship Between Uniaxial Compression, Triaxial, and Tensile Strength of Intact Rock in Mohr-Coulomb Diagram.

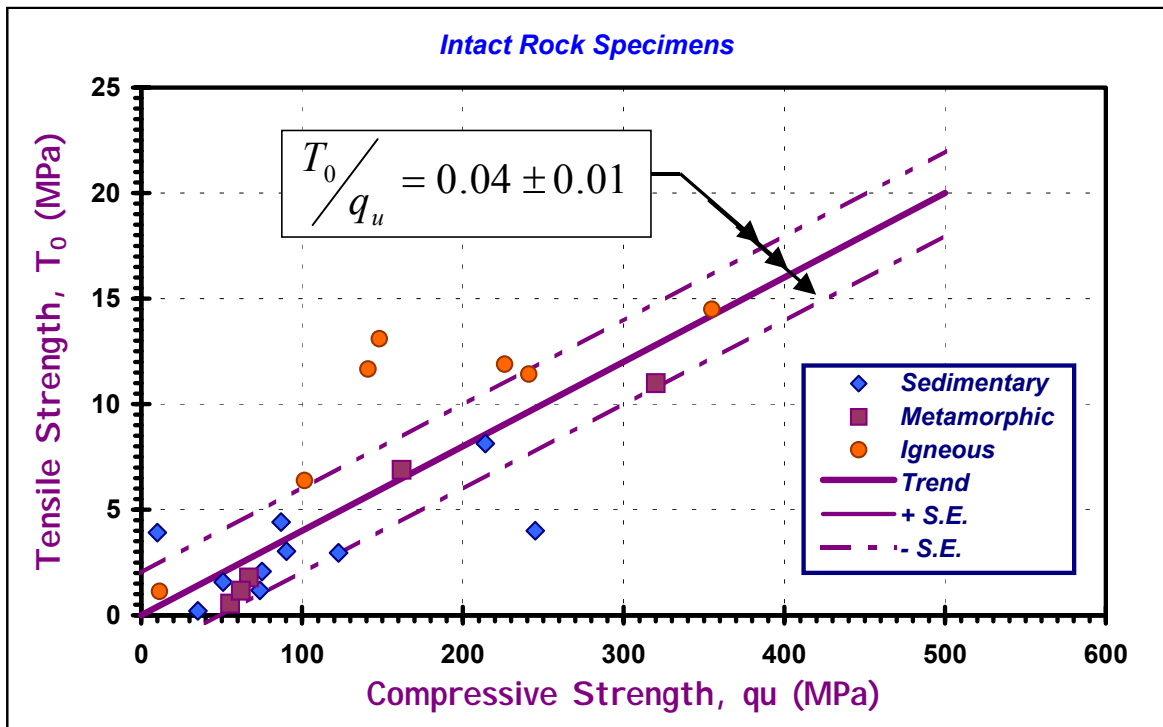


Figure 10-8. Comparison of Tensile vs. Compressive Strengths for Intact Rock Specimens.



### 10.2.6 Elastic Modulus of Intact Rock

The Young's modulus ( $E_R$ ) of intact rock is measured during uniaxial compression or triaxial compression loading (See Figure 8-6). The equivalent elastic modulus is the slope of the  $F$ - $\epsilon$  curve and can be assessed as either a tangent value ( $E_t = \Delta F / \Delta \epsilon$ ), or a secant value ( $E_s = F / \epsilon$ ) from the initial loading. Also, it may be evaluated from an unload-reload cycle implemented off of the initial loading ramp. Most common in engineering practice, the tangent value taken at 50% of ultimate strength is reported as the characteristic elastic modulus ( $E_{R50}$ ).

Intact rock specimens can exhibit a wide range of elastic modulus, as evidenced by Table 10-4. For these data, the measured values vary from 3.6 to 88.3 GPa (530 to 12815 ksi), with a mean value of  $E_R = 44.6$  GPa (6500 ksi). Notably, these moduli are comparable to normal and high-strength concretes that are manufactured for construction. For many sedimentary and foliated metamorphic rocks, the modulus of elasticity is generally greater parallel to the bedding or foliation planes than perpendicular to them, due to closure of parallel weakness planes.

An intact rock classification system based on strength and modulus ratio ( $E_t/F_u$ ) is given in Table 10-5. For each of the basic rock types (igneous, sedimentary, and metamorphic), Figure 10-9 shows the corresponding groupings of elastic modulus ( $E_t$ ) vs. uniaxial compressive strength ( $F_u$ ). The modulus here is the tangent modulus at 50% of ultimate strength. The broad range of strengths and moduli shown in the three figures is informative. The above system considers intact rock specimens only and does not consider the natural fractures (discontinuities) in the rock mass.

**TABLE 10-5**

### ENGINEERING CLASSIFICATION OF INTACT ROCK

(Deere and Miller, 1966; Stagg and Zienkiewicz, 1968)

#### I. On basis of strength, $F_u$

Class	Description	Uniaxial compressive strength (MPa)
A	Very high strength	Over 220
B	High strength	110-220
C	Medium strength	55-110
D	Low strength	28-55
E	Very low strength	Less than 28

#### II. On basis of modulus ratio, $E_t/F_u$

Class	Description	Modulus ratio <sup>b</sup>
H	High modulus ratio	Over 500
M	Average (medium) ratio	200-500
L	Low modulus ratio	Less than 200

<sup>a</sup> Rocks are classified by strength and modulus ratio such as AM, BL, BH, CM, etc.. <sup>b</sup>Modulus ratio =  $E_t/F_{a(ult)}$  where  $E_t$  is tangent modulus at 50% ultimate strength and  $F_{a(ult)}$  is the uniaxial compressive strength.

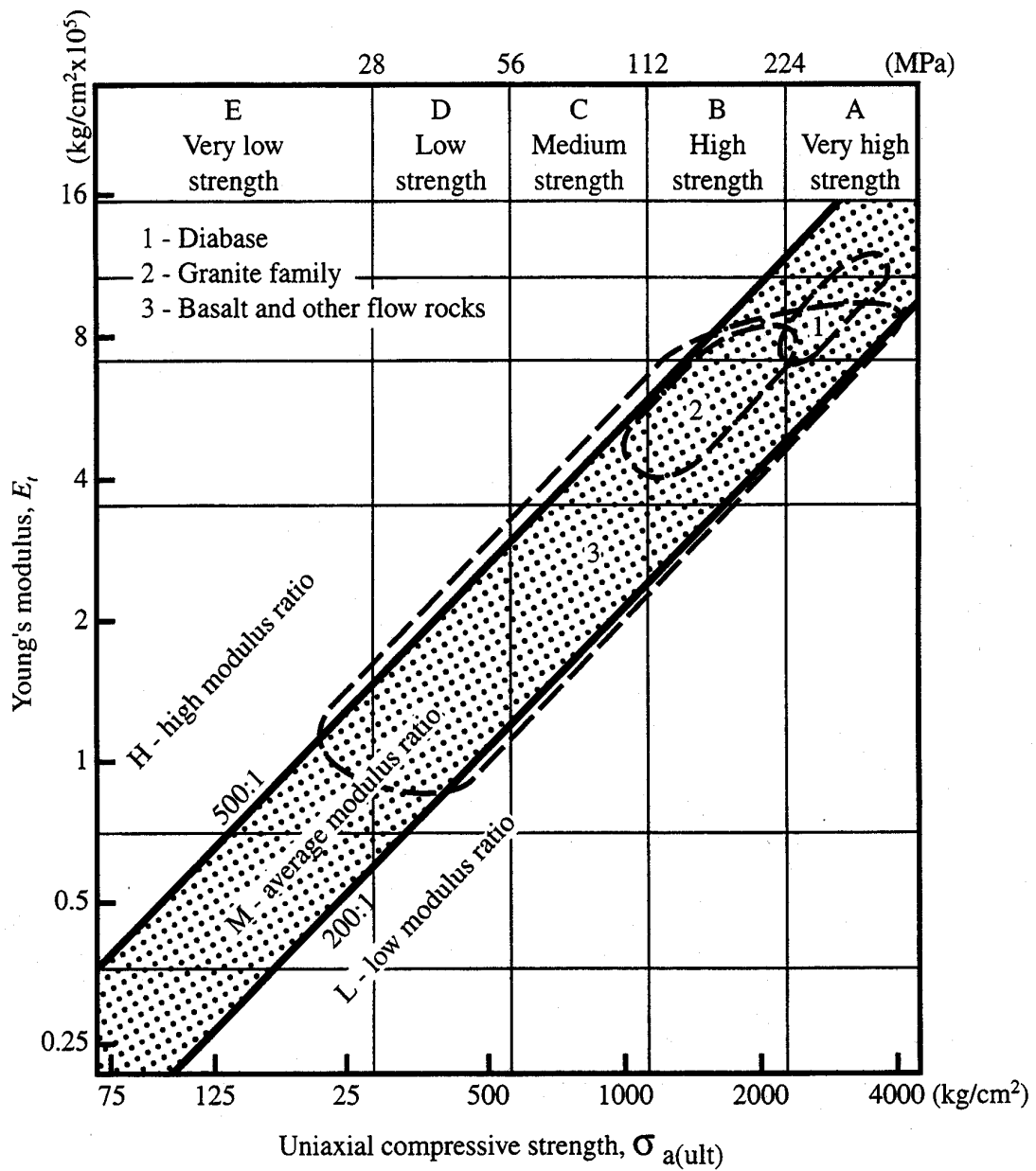


Figure 10-9a. Elastic Modulus-Compressive Strength Groupings for Intact Igneous Rock Materials (Deere & Miller, 1966).

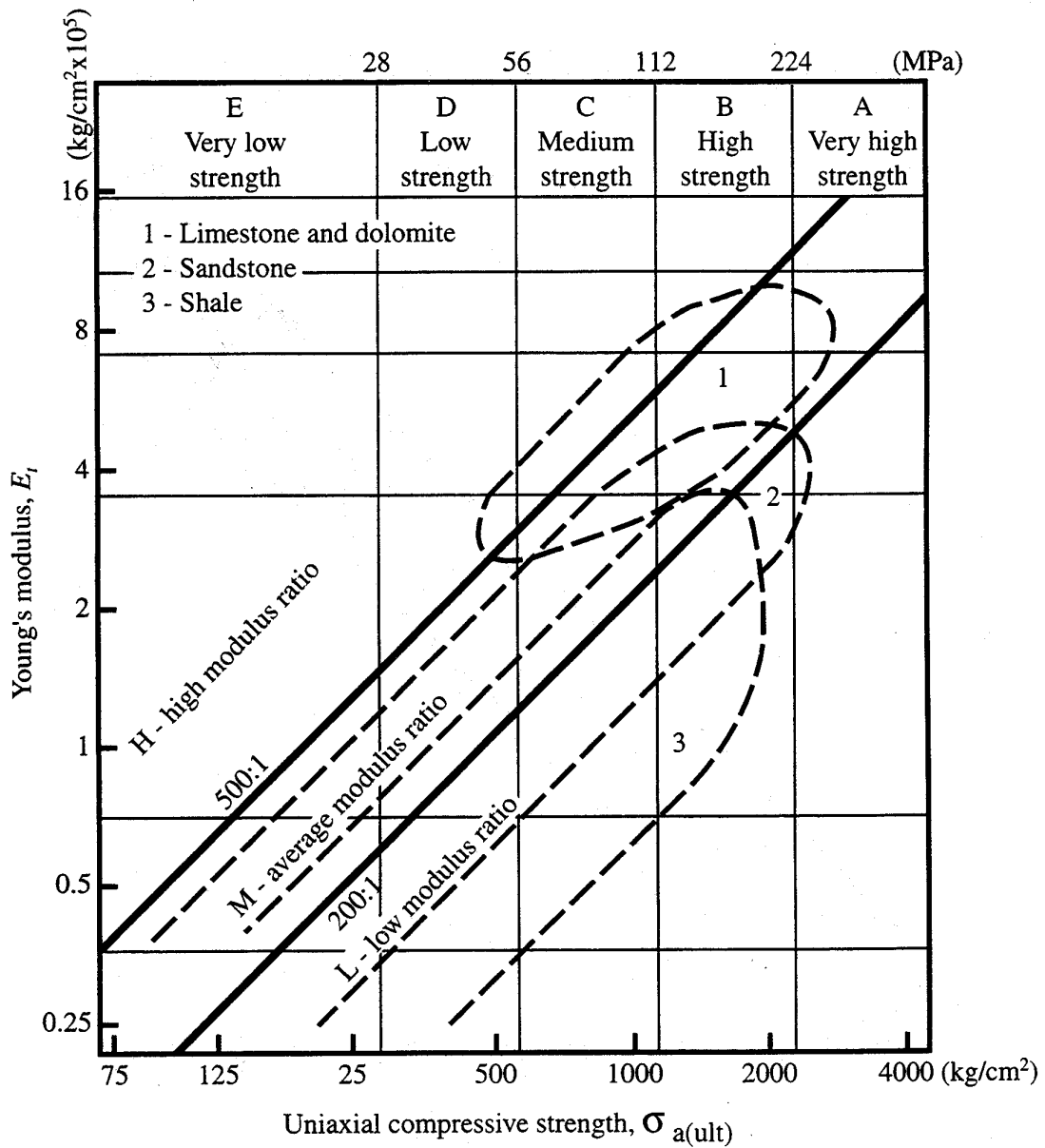


Figure 10-9b. Elastic Modulus-Compressive Strength Groupings for Intact Sedimentary Rock Materials (Deere & Miller, 1966).

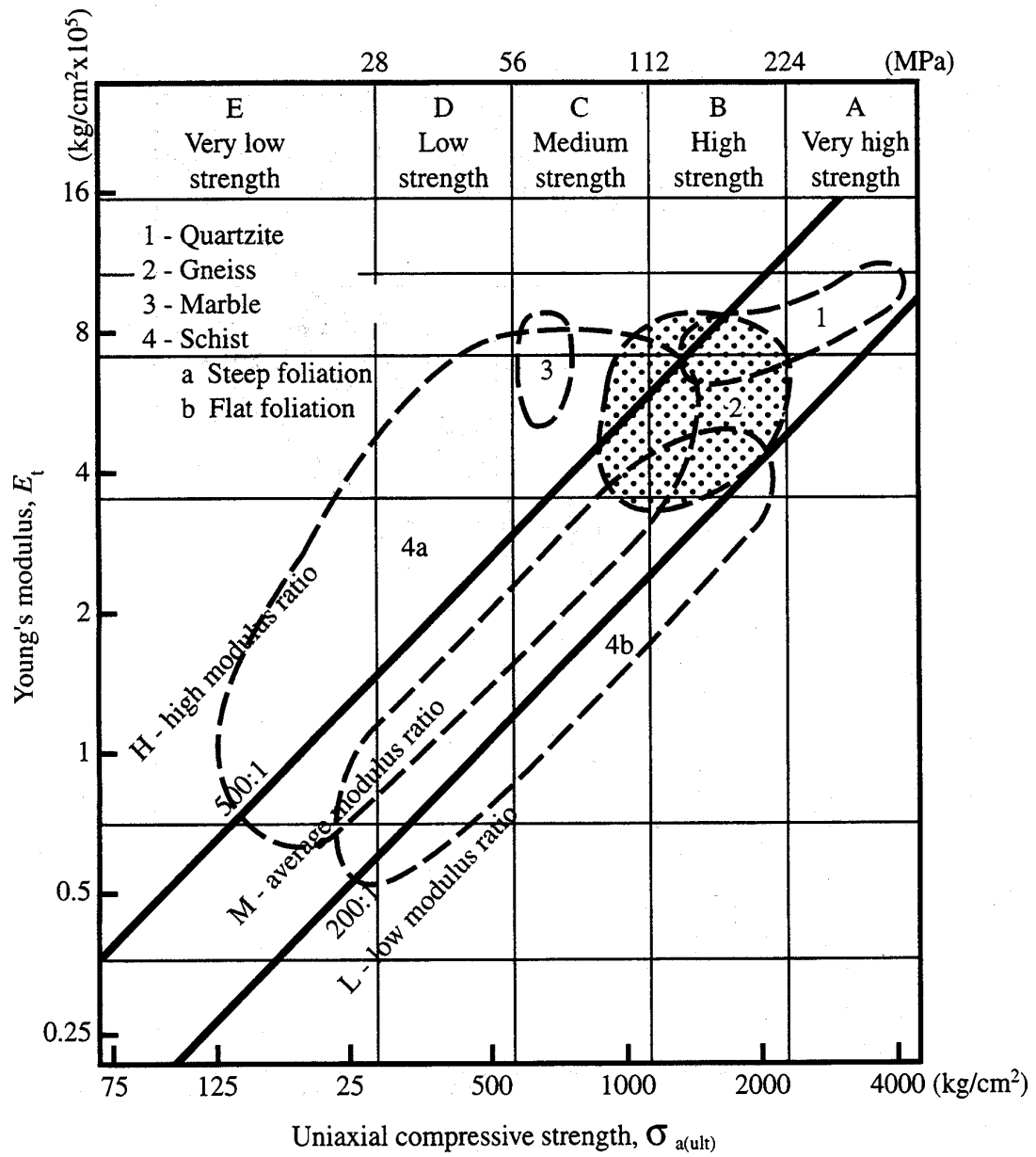


Figure 10-9c. Elastic Modulus-Compressive Strength Groupings for Intact Metamorphic Rock Materials (Deere & Miller, 1966).

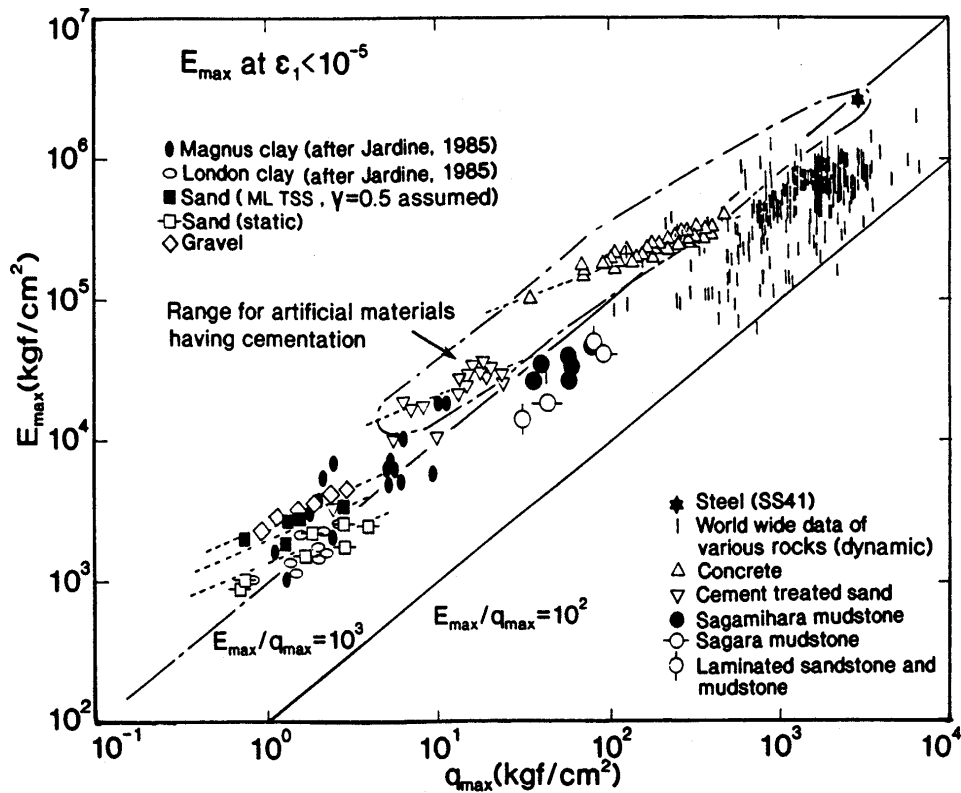


Figure 10-10. Small-Strain Elastic Modulus ( $E_{max}$ ) versus Compressive Strength ( $q_u$ ) for All Types of Civil Engineering Materials. (Tatsuoka & Shibuya, 1992).

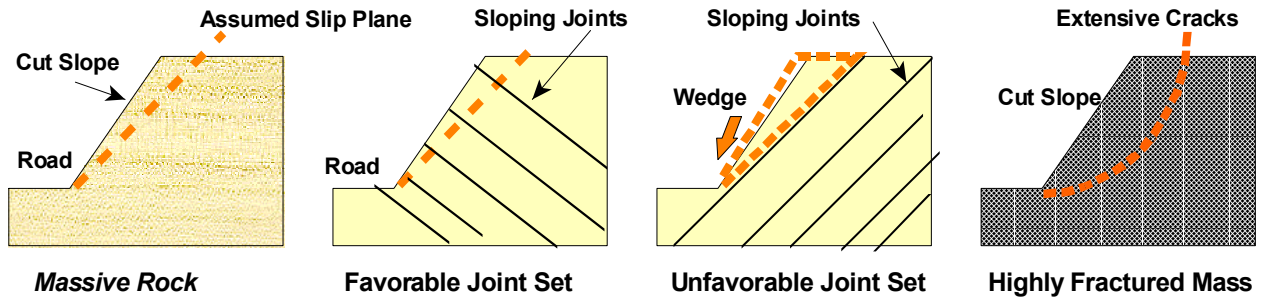
For lab testing on intact rock specimens, the nondestructive elastic modulus at very small strains is obtained from ultrasonics measurements and this value is higher than moduli measured at intermediate to high strains, such as  $E_{150}$ . Figure 10-3d shows a global database of  $E_{max}$  from small-strain measurements (ultrasonics, bender elements, resonant column) versus the compressive strength ( $q_{max} = q_u$ ) for a wide range of civil engineering materials ranging from soils to rocks, as well as concrete and steel (Tatsuoka & Shibuya, 1992).

### 10.3 Operational Shear Strength

The shear strength of rock usually controls in the geotechnical evaluation of slopes, tunnels, excavations, and foundations. As such, the shear strength ( $\tau$ ) of in-place rock often needs to be defined at three distinct levels: (a) intact rock, (b) along a rock joint or discontinuity plane, and (c) representative of an entire fractured rock mass. Figure 10-11 illustrates these cases for the illustrative example involving a road highway cut in rock. In all cases, the shear strength is most commonly determined in terms of the Mohr-Coulomb criterion (Figure 10-7):

$$\tau = c' + \sigma' \tan \phi' \quad (10-3)$$

where  $\tau$  = operational shear strength,  $\sigma'$  = effective normal stress on the plane of shearing,  $c'$  = effective cohesion intercept, and  $\phi'$  = effective friction angle. The appropriate values of the Mohr-Coulomb parameters  $c'$  and  $\phi'$  will depend greatly upon the specific cases considered and levels of failure applicable per Figure 10-11.



**Figure 10-11. Illustrative Cases for Defining Rock Shear Strength for Cut, including: (a) intact rock strength, (b) intact strength across joints, (c) shear strength along joint planes, and (d) jointed rock mass.**

For the intact rock, series of triaxial compressive strength tests can be performed at increasing confining stresses to define the Mohr-Coulomb envelope and corresponding  $c'$  and  $\phi'$  parameters. See Section 7.1.8 for further details on this approach. Alternatively, empirical methods based on the type of rock material and its measured uniaxial compressive strength ( $q_u = \sigma_u$ ) are available for evaluating the shear strength parameters of intact rock (e.g., Hoek, et al. 1995), as discussed later in Section 10.4. This approach is versatile as it can be reduced to account for the degree of fracturing and weathering, thus also used to represent and estimate the shear strength of rock masses.

Laboratory direct shear testing can be used to determine the shear strength of a discontinuity and/or the infilling material found within the joints. The split box is orientated with the axis along the preferred plane of interest (Figure 8-4). The shear strength of the discontinuity surface has either a representative peak or residual value of the frictional component of shear strength. Peak shear strengths will apply during highway cuts and excavations in rocks where no movement has occurred before. Residual shear strengths will be appropriate in restoration and remedial work involving rockslides and slipped wedges or blocks of rock. Relatively small movements can reduce shear strength from peak to residual values. The peak values can be conceived as the composite of the residual shear strength and a geometrical component that depends on roughness and related to asperities and roughness on the joint plane. Table 10-6 lists values of peak friction angle of various rock surface types, rock minerals (that may coat the joints), and infilling materials (such as clays and sands). If the joints are open enough, the infilling of clay/soil may dominate the shear strength behavior of the situation.

Movement reduces (or removes) the effect of the asperities, resulting in reduced shear strength. If sufficient movement occurs, the residual strength of the material is reached. Table 10-7 presents a selection of reported values of residual frictional angle ( $\phi'_r$ , assuming  $c'_r = 0$ ) for various types of rock surfaces and minerals found in rock joints and discontinuities. These values can give an approximate guide in selecting interface and joint strengths.

Additional guidelines for the selection of Mohr-Coulomb parameters are given by Hoek, et al. (1995) and Wyllie (1999).

TABLE 10-6

FRICTION ANGLES FOR ROCK JOINTS, MINERALS, AND FILLINGS

(after compilations by Franklin & Dusseault, 1989, and Jaeger & Cook, 1977)

Condition/Case	Friction Angle $N'$ (deg) ( $c' = 0$ )
<i>Thick joint fillings:</i>	
Smectite and montmorillonitic clays	5 - 10
Kaolinite	12 - 15
Illite	16 - 22
Chlorite	20 - 30
Quartzitic sand	33 - 40
Feldspathic sand	28 - 35
<i>Minerals:</i>	
Talc	9
Serpentine	16
Biotite (mica)	7
Muscovite (mica)	13
Calcite	8
Feldspar	24
Quartz	33
<i>Rock joints:</i>	
Crystalline limestone	42 - 49
Porous limestone	32 - 48
Chalk	30 - 41
Sandstone	24 - 35
Quartzite	23 - 44
Clay Shale	22 - 37
Bentonitic Shale	9 - 27
Granite	31 - 33
Dolerite	33 - 43
Schist	32 - 40
Marble	31 - 37
Gabbro	33
Gneiss	31 - 35

**TABLE 10-7****RESIDUAL FRICTION ANGLES**

(compilations after Barton, 1973, and Hoek &amp; Bray, 1977)

<b>Rock Type</b>	<b>Residual Friction Angle <math>N_r</math> (degrees), assuming <math>c' = 0</math></b>
Amphibolite	32
Basalt	31-38
Conglomerate	35
Chalk	30
Dolomite	27-31
Gneiss (schistose)	23-29
Granite (fine grain)	29-35
Limestone	33-40
Porphyry	31
Sandstone	25-35
Shale	27
Siltstone	27-31
Slate	25-30

Note: Lower value is generally given by tests on wet rock surfaces.

**10.4 ROCK MASS CLASSIFICATION**

While the mineral composition, age, and porosity determine the properties of the intact rock, the network of fractures, cracks, and joints govern the rock mass behavior in terms of available strength, stiffness, permeability, and performance. The pattern of discontinuities of the rock mass will be evident in the cored sections obtained during the site exploration studies, as well as in the exposed faces and rock outcrops in the topographic terrain. A selection of exposed rock types is presented in Figure 10-12 to illustrate the variations that occur in scenery due to the inherent fracture and joint patterns.

Measures of quantifying the degree, extent, and nature of the discontinuities is paramount in assessing the quality and condition of the rock mass. The rock quality designation (RQD, described in Figure 3-20) is a first-order assessment of the amount of natural jointing and fissuring in rock masses. The RQD has been used to approximately quantify the rock mass behavior, yet was developed four decades ago (Deere & Deere, 1989). Since then, more elaborate and quantitative methods of assessing the overall rock mass condition have been developed including the Geomechanics RMR-System (Bieniawski, 1989), based on mining experiences in South Africa, and the NGI-Q system (Barton, 1988), based on tunneling experiences in Norway. A closely related system to the RMR is the Geological Strength Index (GSI) that will be useful in assessing the strength of rock masses. These and other rock mass classifications systems are described in detail elsewhere and summarized in ASTM D 5878 (Classification of Rock Mass Systems). The influential factors that comprise the rock mass ratings will be briefly discussed here and presented in the context for the interpretation of rock mass properties need for design and analysis of slopes, tunnels, and foundations in rock formations.





**Figure 10-12 (a). Limestone at I-75, TN**



**Figure 10-12 (b). Sandstone in Grand Canyon, AZ**



**Figure 10-12 (c). Basalt Beach, Kauai, HI**



**Figure 10-12 (d). Mica Schist near Hope, BC**



**Figure 10-12 (e). Gneiss at Sondstrom, Greenland.**



**Figure 10-12(f). Exposed Granite, Rio, Brazil**

**Figure 10-12. Selection of Exposed Rock Masses from Different Geologic Origins.**

### 10.4.1 Rock Mass Rating System (RMR)

The Rock Mass Rating (RMR) rock classification system uses five basic parameters for classification and properties evaluation. A sixth parameter helps further assess issues of stability to specific problems. Originally intended for tunneling & mining applications, it has been extended for the design of cut slopes and foundations. The six parameters used to determine the RMR value are:

- ' Uniaxial compressive strength ( $q_u$  or  $\sigma_u$ )\*.
- ' Rock Quality Designation (RQD)
- ' Spacing of discontinuities
- ' Condition of discontinuities
- ' Groundwater conditions
- ' Orientation of discontinuities

\*Note: Value may be estimated from point load index ( $I_p$ ).

The basic components of the RMR system is contained in Figure 10-13. The rating is obtained by summing the values assigned for the first five components. Later, an overall rating can be made by a final adjustment by consideration of the sixth component depending upon the intended project type (tunnel, slope, or foundation), however, this is less utilized in most routine applications. Thus, the RMR is determined as:

$$RMR = \sum_{i=1}^5 G(R_i) \quad (10-4)$$

The RMR rating assigns a value of between 0 (very poor) to 100 (most excellent) for the rock mass. The RMR system has been modified over the years with additional details and variants given elsewhere (e.g., Bieniawski, 1989; Hoek, et al., 1995; Wyllie, 1999). Depending upon the dip and dip direction (or strike) of the natural discontinuities with respect to the proposed layout and orientation of the construction, then an additional factor may be added to adjust the RMR, ranging from favorable ( $R_6 = 0$ ) to very unfavorable (-12 for tunnels, -25 for foundations, and -60 for slopes).

### 10.4.2. NGI - Q Rating

The Q Rating was developed for assessing rock masses for tunneling applications by the Norwegian Geotechnical Institute (Barton, et al. 1974) and relies on six parameters for evaluation:

- Rock Quality Designation (RQD)
- $J_n$  is the number of discontinuity sets in the rock mass (joint sets).
- $J_r$  represents the roughness of the interface within the discontinuities, fractures, and joints.
- $J_a$  describes the condition, alterations, and infilling material with the joints and cracks.
- $J_w$  provides an assessment on the in-place water conditions.
- SRF is a stress reduction factor related to the initial stress state and compactness.

The individual parameters are assigned values per the criteria given in Figure 10-14 and then a complete Q rating is obtained as follows:

$$Q = \left( \frac{RQD}{J_n} \right) \left( \frac{J_r}{J_a} \right) \left( \frac{J_w}{SRF} \right) \quad (10-5)$$

**ROCK MASS RATING (RMR)**

also CSIR System

Geomechanics System - (Bieniawski, 1984, 1989)

Geomechanics Classification for Rock Masses		
CLASS	DESCRIPTION	RANGE of RMR
I	Very Good Rock	81 to 100
II	Good Rock	61 to 80
III	Fair Rock	41 to 60
IV	Poor Rock	21 to 40
V	Very Poor Rock	0 to 20

$$RMR = \sum_{i=1}^5 R_i$$

NOTE: Rock Mass Rating is obtained by summing the five index parameters to obtain an overall rating RMR. Adjustments for dip and orientation of discontinuities being favorable or unfavorable for specific cases of tunnels, slopes, & foundations can also be considered.

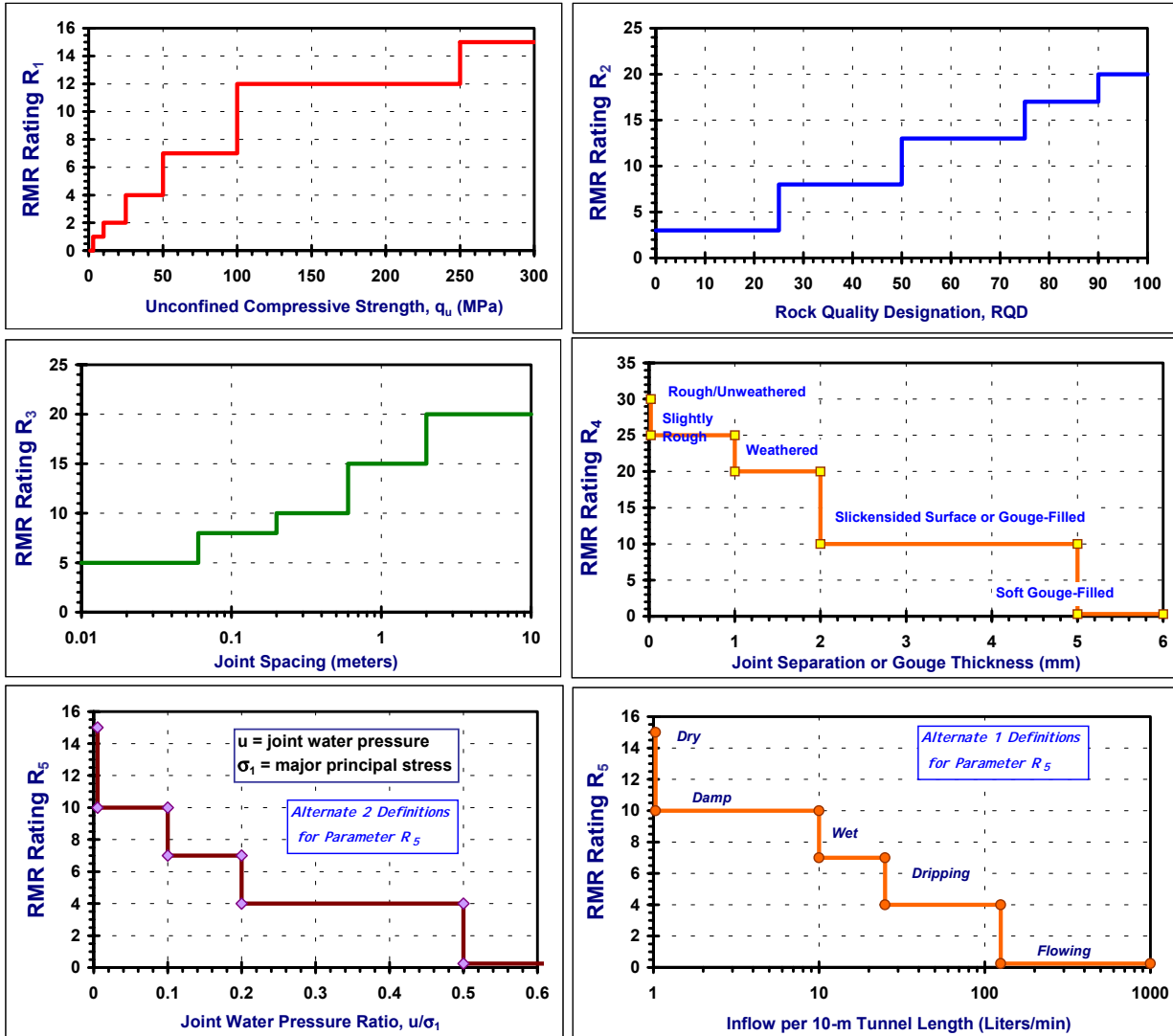


Figure 10-13. The Geomechanics Classification System for Rock Mass Rating (RMR) (after Bieniawski, 1984, 1989).

## NGI Q-System Rating for Rock Masses

(Barton, Lien, & Lunde, 1974)

<i>Norwegian Classification for Rock Masses</i>	
Q - Value	Quality of Rock Mass
< 0.01	Exceptionally Poor
0.01 to 0.1	Extremely Poor
0.1 to 1	Very Poor
1 to 4	Poor
4 to 10	Fair
10 to 40	Good
40 to 100	Very Good
100 to 400	Extremely Good
< 400	Exceptionally Good

PARAMETERS FOR THE Q-RATING OF ROCK MASSES	
1. RQD = Rock Quality Designation = sum of cored pieces > 100 mm long, divided by total core run length	
2. Number of Sets of Discontinuities (joint sets) = $J_n$	
<i>Massive</i>	0.5
<i>One set</i>	2
<i>Two sets</i>	4
<i>Three sets</i>	9
<i>Four or more sets</i>	15
<i>Crushed rock</i>	20
3. Roughness of Discontinuities* = $J_r$	
<i>Noncontinuous joints</i>	4
<i>Rough, wavy</i>	3
<i>Smooth, wavy</i>	2
<i>Rough, planar</i>	1.5
<i>Smooth, planar</i>	1
<i>Slick and planar</i>	0.5
<i>Filled discontinuities</i>	1
*Note: add +1 if mean joint spacing > 3 m	

$$Q = (RQD/J_n)(J_r/J_a)(J_w/SRF)$$

4. Discontinuity Condition & Infilling = $J_a$	
4.1 Unfilled Cases	
<i>Healed</i>	0.75
<i>Stained, no alteration</i>	1
<i>Silty or Sandy Coating</i>	3
<i>Clay coating</i>	4
4.2 Filled Discontinuities	
<i>Sand or crushed rock infill</i>	4
<i>Stiff clay infilling &lt; 5 mm</i>	6
<i>Soft clay infill &lt; 5 mm thick</i>	8
<i>Swelling clay &lt; 5 mm</i>	12
<i>Stiff clay infill &gt; 5 mm thick</i>	10
<i>Soft clay infill &gt; 5 mm thick</i>	15
<i>Swelling clay &gt; 5 mm</i>	20
5. Water Conditions	
<i>Dry</i>	1
<i>Medium Water Inflow</i>	0.66
<i>Large inflow in unfilled joints</i>	0.5
<i>Large inflow with filled joints that wash out</i>	0.33
<i>High transient flow</i>	0.2 to 0.1
<i>High continuous flow</i>	0.1 to 0.05
6. Stress Reduction Factor** = SRF	
<i>Loose rock with clay infill</i>	10
<i>Loose rock with open joints</i>	5
<i>Shallow rock with clay infill</i>	2.5
<i>Rock with unfilled joints</i>	1
**Note: Additional SRF values given for rocks prone to bursting, squeezing and swelling by Barton et al. (1974)	

**Figure 10-14. The Q-Rating System for Rock Mass Classification**  
(after Barton, Lien, and Lunde, 1974).

Both the RMR and the Q-ratings can be used to evaluate the stand-up time of unsupported mine & tunnel walls which is valuable during construction. The RMR and Q are also used to determine the type and degree of tunnel support system required for long-term stability, including the use of shotcrete, mesh, lining, and rock bolt spacing. Details on these facets are given elsewhere (e.g., Hoek, et al., 1995).

### 10.4.3. Geological Strength Index (GSI)

Whereas the RMR and Q systems were developed originally for mining and tunnelling applications, the Geological Strength Index (GSI) provides a measure of the rock mass quality for directly assessing the strength and stiffness of intact and fractured rocks. A quick assessment of the GSI made be made by use of the graphical chart given in Figure 10-15, thus facilitating the procedure for field use.

More specifically, the GSI can be calculated from the components of the Q system, as follows:

$$GSI = 9 \cdot \log \left[ \left( \frac{RQD}{J_n} \right) \left( \frac{J_r}{J_a} \right) \right] + 44 \quad (10-6)$$

In relation to the common Geomechanics Classification System, the GSI is restricted to RMR values in excess of 25, thus:

$$\text{For RMR} > 25: \quad GSI = \sum_{i=1}^4 G(R_i) + 10 \quad (10-7)$$

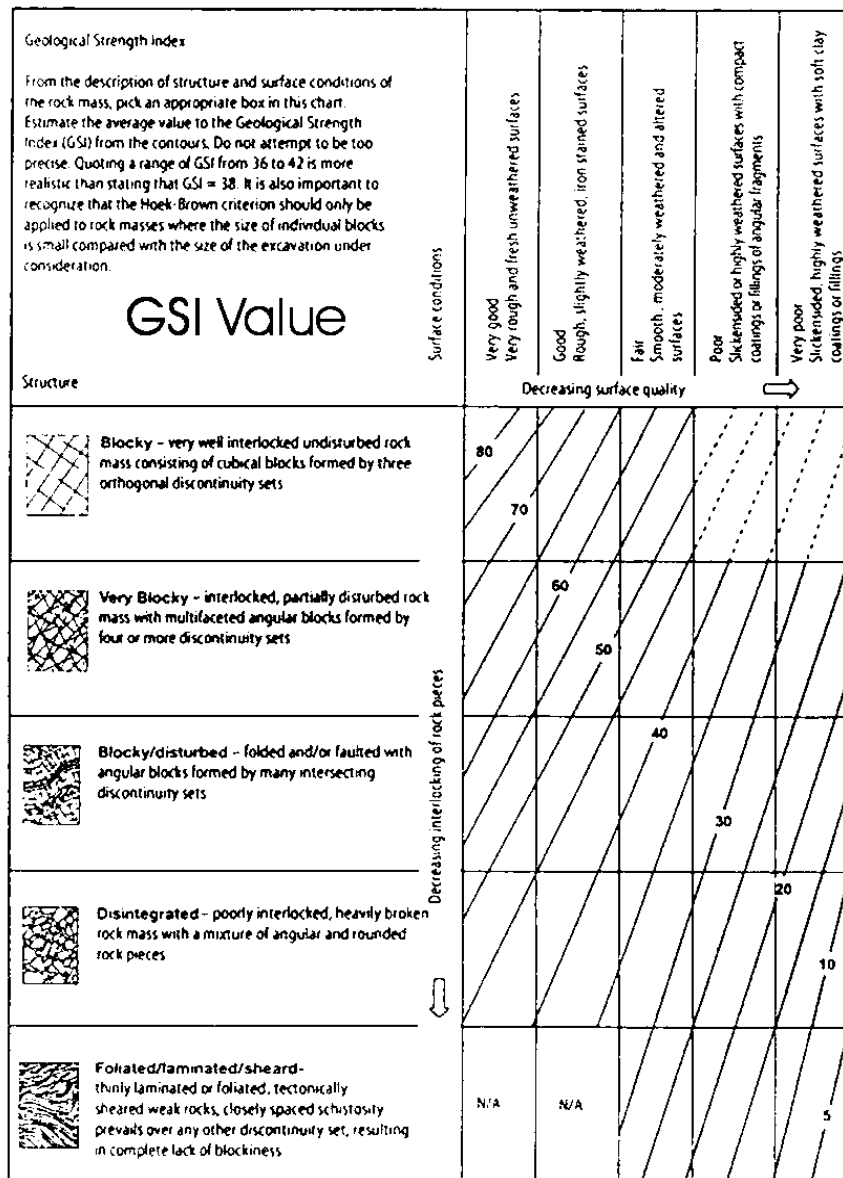


Figure 10-15. Chart for Estimating the Geological Strength Index (GSI) (Hoek & Brown, 1997).

## 10.5. ROCK MASS STRENGTH

The strength of the overall assemblage of rock blocks and fractures can be assessed by large direct shear tests conducted in the field, backcalculation of rockslides and failed slopes, or alternatively estimated on the basis of rock mass classification schemes. For the latter, a detailed approach to evaluating the rock mass strength is afforded through use of the GSI rating (Hoek, et al. 1995). In this method, the major principal stress ( $F_1r$ ) is related to the minor principal stress ( $F_3r$ ) at failure through an empirical expression that depends upon the following:

- The uniaxial compressive strength of the rock material ( $F_u$ )
- A material constant ( $m_i$ ) for the type of rock
- Three empirical parameters that reflect the degree of fracturing of the rock mass ( $m_b$ ,  $s$ , and  $a$ ).

The relationship accounts for curvature of the Mohr-Coulomb strength envelope and gives the expression for major principal stress in the form:

$$\sigma_1' = \sigma_3' + \sigma_u \left[ m_b \frac{\sigma_3'}{\sigma_u} + s \right]^a \quad (10-8)$$

The material parameter  $m_i$  depends on the specific rock type (igneous, metamorphic, or sedimentary) as determined from the chart given in Figure 10-16. Values range as low as 4 for mudstone to as high as 33 for gneiss and granite.

For  $GSI > 25$ , the remaining strength parameters for undisturbed rock masses are:

$$m_b = m_i \exp [(GSI-100)/28] \quad (10-9)$$

$$s = \exp [(GSI-100)/9] \quad (10-10)$$

$$a = 0.5 \quad (10-11)$$

For  $GSI < 25$ , the parameter selection is given by:

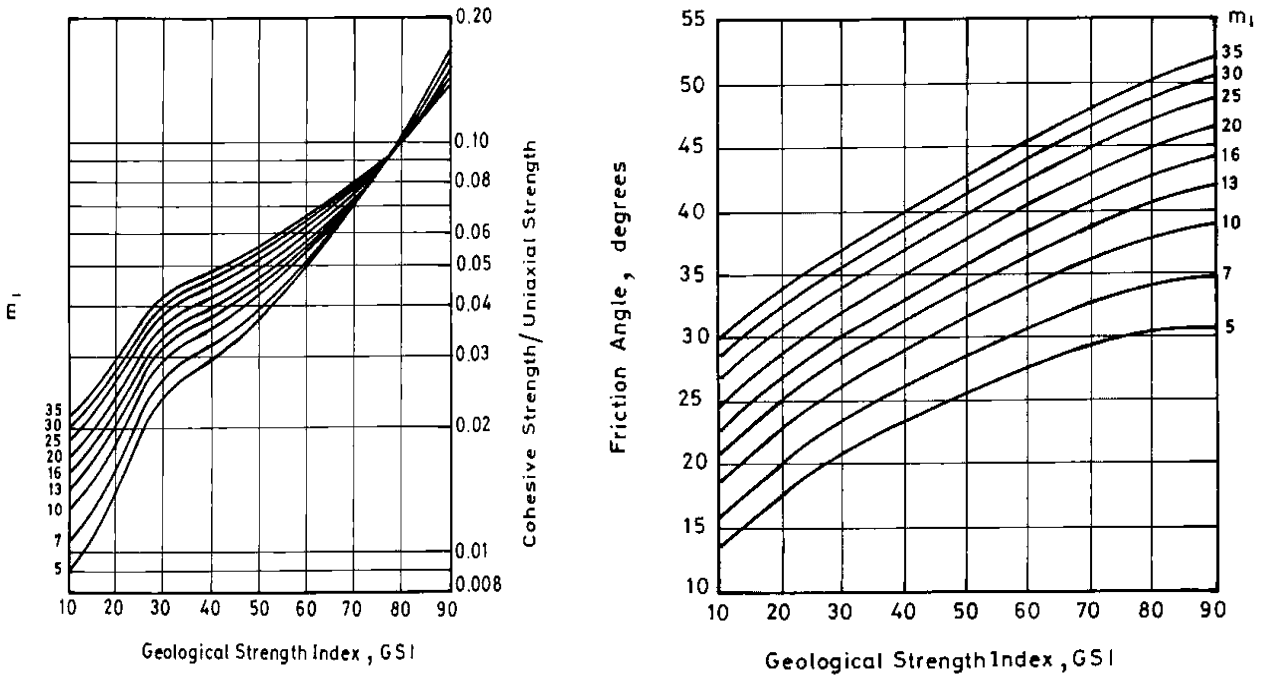
$$s = 0 \quad (10-12)$$

$$a = 0.65 - (GSI/200) \quad (10-13)$$

Thus, the evaluation is easily carried out using a spreadsheet with adopted values of effective confining stresses ( $F_3r$ ) taken over the range of anticipated field overburden stresses to calculate corresponding values of effective major principal stress at failure ( $F_1r$ ) by equation (10-8). Then, the paired values of  $F_1r$  and  $F_3r$  can be plotted [using either Mohr's Circles or q-p plots] to obtain the equivalent shear strength parameters,  $c/r$  and  $Nr$ . Note that the method can also be applied to evaluate the strength of intact rock ( $GSI = 100$ ), as well as fractured rock. For quick assessments, representative and average values of  $F_3r$  have been used to derive approximate chart solutions for selecting normalized  $c/r/F_u$  and friction angle  $Nr$  directly from GSI and material constant  $m_i$ , as presented in Figure 10-17.

Rock type	Class	Group	Texture			
			Course	Medium	Fine	Very fine
SEDIMENTARY	Clastic		Conglomerate (22)	Sandstone 19	Siltstone 9	Claystone 4
			← Greywacke → (18)			
	Non-Clastic	Organic	← Chalk → 7			
			← Coal → (8-21)			
	Carbonate	Breccia (20)	Sparitic Limestone (10)	Micritic Limestone 8		
	Chemical		Gypstone 16	Anhydrite 13		
METAMORPHIC	Non Foliated		Marble 9	Hornfels (19)	Quartzite 24	
	Slightly foliated		Migmatite (30)	Amphibolite 31	Mylonites (6)	
	Foliated*		Gneiss 33	Schists (10)	Phyllites (10)	Slate 9
IGNEOUS	Light		Granite 33		Rhyolite (16)	Obsidian (19)
			Granodiorite (30)		Dacite (17)	
	Dark		Diorite (28)		Andesite 19	
			Gabbro 27	Dolerite (19)	Basalt (17)	
		Norite 22				
	Extrusive pyroclastic type		Agglomerate (20)	Breccia (18)	Tuff (15)	

Figure 10-16. Material Constant  $m_i$  for GSI Evaluation of Rock Mass Strength (Hoek, et al., 1995).



**Figure 10-17. Approximate Chart Solution for Obtaining Normalized Cohesion Intercept ( $c/F_u$ ) and Friction Angle ( $N_f$ ) from GSI Rating and  $m_i$  Parameter (After Hoek & Brown, 1997).**

For the apparent shear strength along specific joints and planes of sliding, the peak friction angle can be evaluated from the Q-rating parameters ( $c' = 0$ ):

$$\phi_p' = (J_r/J_a) \quad (10-14)$$

which gives a range of  $7^\circ < \phi_p' < 75^\circ$  for the full value limits of joint roughness ( $J_r$ ) and alteration ( $J_a$ ) parameters.

## 10.6. ROCK MASS MODULUS

The equivalent elastic modulus ( $E_M$ ) of rock masses is used in deformation analyses and numerical simulations involving tunnels, slopes, and foundations to estimate magnitudes of movements and deflections caused by new loading. Field methods of measuring the deformability characteristics of rock masses include the Goodman jack and rock dilatometer, as well as backcalculation from full-scale foundation load tests (e.g., Littlechild, et al., 2000). For routine calculations,  $E_M$  has been empirically related to intact rock properties (uniaxial strength,  $F_u$ , and elastic modulus of the intact rock,  $E_R$ ), rock quality (RQD), and rock mass ratings (RMR, Q, and GSI), such as given by the expressions listed in Table 10-7. On critical projects, the actual stiffness of the rock formation can be assessed using full-scale load tests, made more practical in recent times by the advent of the Osterberg load cell which can apply very large forces using embedded hydraulic systems.



**TABLE 10-8**

**EMPIRICAL METHODS FOR EVALUATING  
ELASTIC MODULUS ( $E_M$ ) OF ROCK MASSES**

<b>Expression</b>	<b>Notes/Remarks</b>	<b>Reference</b>
For RQD < 70: $E_M = E_R (RQD/350)$ For RQD > 70: $E_M = E_R [0.2 + (RQD-70)37.5]$	Reduction factor on intact rock modulus	Bieniawski (1978)
$E_M = E_R [0.1 + RMR/(1150 - 11.4 RMR)]$	Reduction factor	Kulhawy (1978)
$E_M$ (GPa) = 2 RMR - 100	45 < RMR < 90	Bieniawski (1984)
$E_M$ (GPa) = 25 Log <sub>10</sub> Q	1 < Q < 400	Hoek et al. (1995)
$E_M$ (GPa) = 10 <sup>[RMR-100]/40</sup>	0 < RMR < 90	Serafim & Pereira (1983)
$E_M$ (GPa) = (0.01F <sub>u</sub> ) 10 <sup>[GSI-100]/40</sup>	Adjustment for rocks with F <sub>u</sub> < 100 MPa	Hoek (1999)

Notes:  $E_R$  = intact rock modulus,  $E_M$  = equivalent rock mass modulus, RQD = rock quality designation, RMR = rock mass rating, Q = NGI rating of rock mass, GSI = geologic strength index,  $F_u$  = uniaxial compressive strength.

**10.7. FOUNDATION RESISTANCES**

In many highway projects, foundations can bear on the rock surface or be embedded into the rock formation to resist large axial loads. For bridge structures, shallow spread footing foundations not subjected to scour can bear directly on the rock. In other instances, deep foundations may consist of large drilled shafts or piers that are constructed into the rock using coring methods. These may be designed for axial compression and/or uplift. In the following sections, methods of estimating the bearing stresses and side resistance in rocks are provided.

**10.7.1 Allowable Foundation Bearing Stress**

Detailed calculations can be made concerning the bearing capacity of foundations situated on fractured rock (e.g., Goodman, 1989). In addition, the results of the field and laboratory characterization program of the rock mass may be used to estimate the allowable bearing values directly. In the most simple approach, presumptive values are obtained from local practice, Uniform and BOCA building codes, and AASHTO guidelines. A summary of allowable bearing stresses from codes has been compiled by Wyllie (1999) and presented in Figure 10-18. If the RQD < 90%, the values given in the figure should be decreased by variable reduction factors ranging from 0.7 to 0.1. In this regard, the approach of Peck, et al. (1974) uses the RQD directly to assess the allowable bearing stress ( $q_{allowable}$ ), provided that the applied stress does not exceed the uniaxial compressive strength of the intact rock ( $q_{allowable} < F_u$ ). The RQD relationship is shown in Figure 10-19. For more specific calculations and detailed evaluations, the results of the equivalent Mohr-Coulomb parameters from either the GSI approach may be used in traditional bearing capacity equations, as discussed by Wyllie (1999).



### 10.7.2. Foundation Side Resistances

Deep foundations can be constructed to bear within rock formations to avert scour problems and resist both axial compression and uplift loading. Drilled shaft foundations can be bored through soil layers and extended deeper by coring into the underlying bedrock. In many cases, the diameter of the drilled shaft is reduced when penetrating the rock, thus making a socket. Figures 10-20 presents a relationship between the shaft side resistance ( $f_s$ ) and one-half the compressive strength ( $q_u/2$ ) for sedimentary rocks, while Figure 10-21 shows a similar diagram between  $f_s$  and  $q_u$  for all rock types.

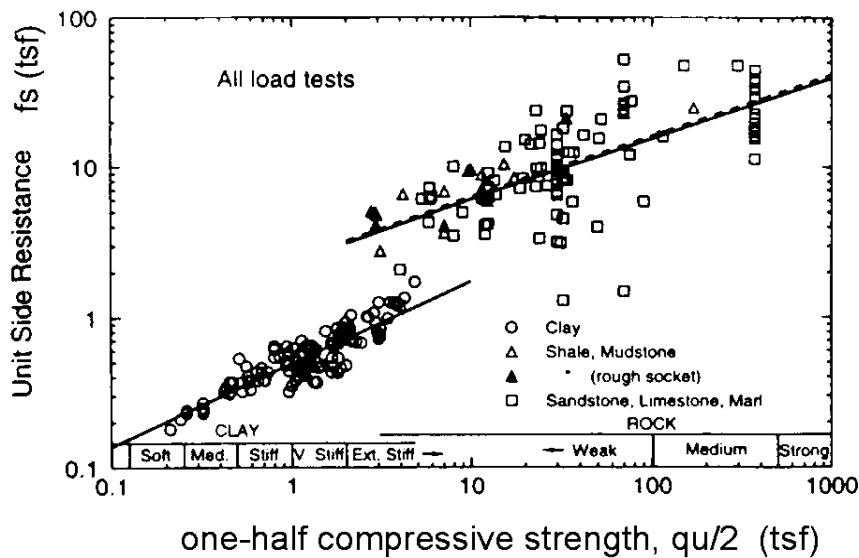


Figure 10-20. Unit Side Resistance Trend with Strength of Sedimentary Rocks (Kulhawy & Phoon, 1993).

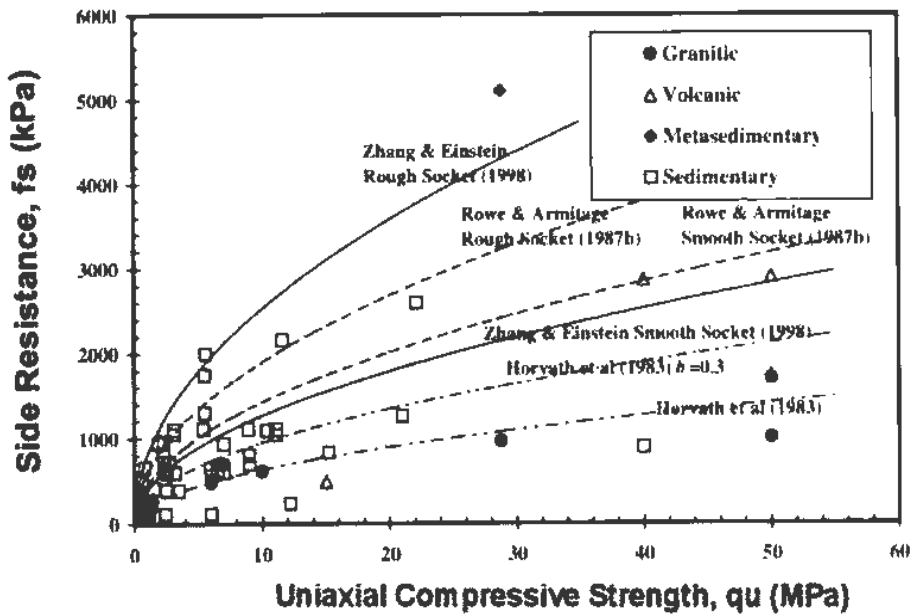
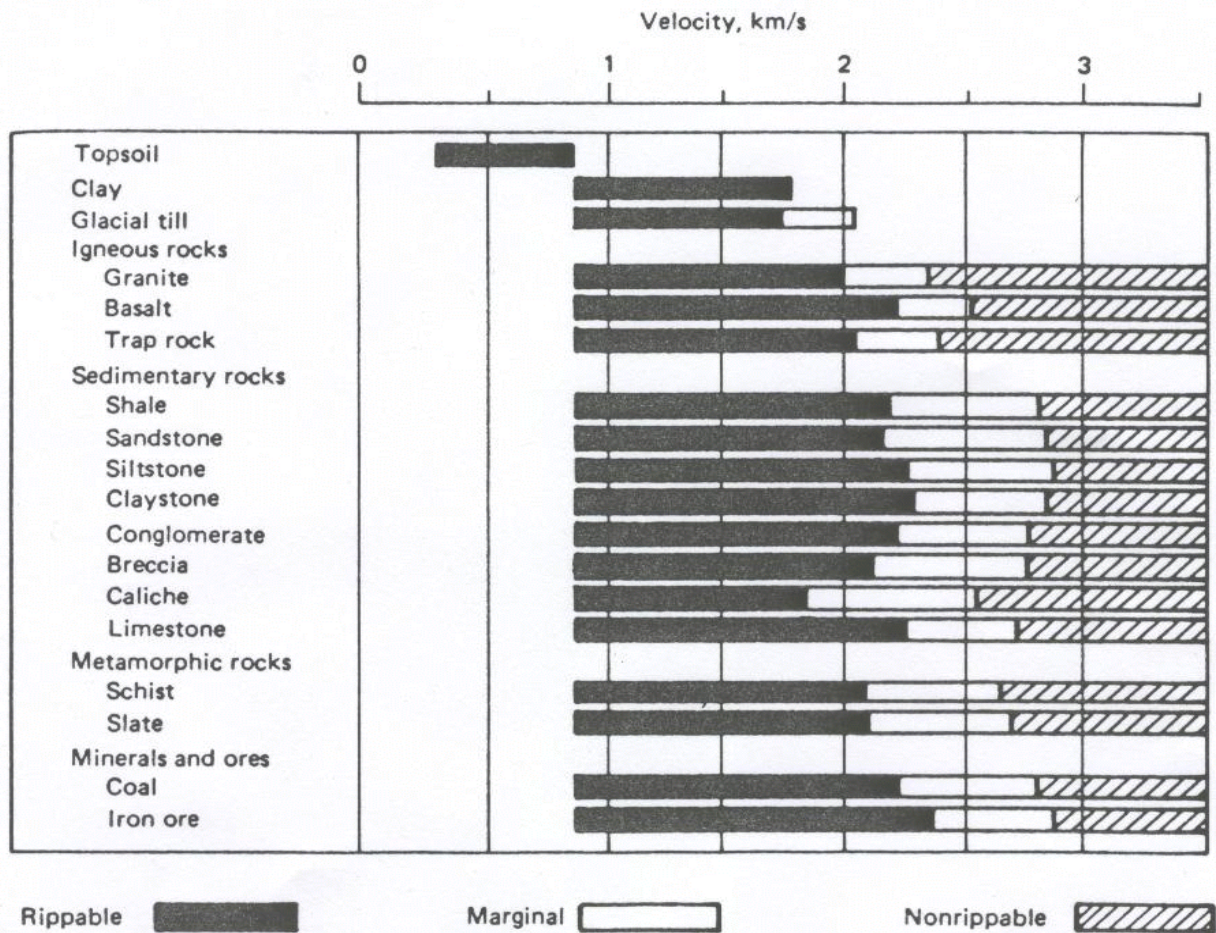


Figure 10-21. Shaft Unit Side Resistance with Various Rock Types (From Ng, et al., 2001).

### 10-8. Additional Rock Mass Parameters

As projects become more complex, there is need to measure and interpret additional geomechanical properties of the intact rock and rock mass. Some recent efforts have included assessments of scour and erodibility that have been related to rock mass indices (Van Schalkwyk, et al., 1995). Similar methodologies have been developed for excavatability of rocks by machinery in order to minimize use of blasting (Wyllie, 1999). A simple approach for the latter purpose utilizes the compression wave velocity ( $V_p$ ) of the in-place rock directly, as shown in Figure 10-22.



**Figure 10-22. Rippability of Inplace Rock by Caterpillar Dozer Evaluate by P-Wave Velocity.**  
(After Franklin and Dusseault, 1989)

## CHAPTER 11.0

### GEOTECHNICAL REPORTS

#### 11.1 TYPES OF REPORTS

Upon completion of the field investigation and laboratory testing program, the geotechnical engineer will compile, evaluate, and interpret the data and perform engineering analyses for the design of foundations, cuts, embankments, and other required facilities. Additionally, the geotechnical engineer will be responsible for producing a report that presents the subsurface information obtained from the site investigations and provides specific technical recommendations. The evaluation and interpretation of the exploratory data were discussed in Chapters 7 and 8 of this module. The geotechnical analyses and design procedures to be implemented for the various types of highway facilities are addressed in various other FHWA publications. This chapter provides guidelines and recommendations for developing a geotechnical report.

Generally, one or more of three types of reports will be prepared: A geotechnical investigation (or data) report; a geotechnical design report; or a geoenvironmental report. The choice depends on the requirements of the highway agency (owner) and the agreement between the geotechnical engineer and the facility designer. The need for multiple types of reports on a single project depends on the project size, phasing and complexity.

##### 11.1.1 Geotechnical Investigation Reports

Geotechnical investigation reports present site-specific data and have three major components:

1. *Background Information:* The initial sections of the report summarize the geotechnical engineer's understanding of the facility for which the report is being prepared and the purposes of the geotechnical investigation. This section would include information on loads, deformations and additional performance requirements. This section also presents a general description of site conditions, geology and geologic features, drainage, ground cover and accessibility, and any peculiarities of the site that may affect the design.
2. *Work Scope:* The second part of the investigation report documents the scope of the investigation program and the specific procedures used to perform this work. These sections will identify the types of investigation methods used; the number, location and depths of borings, exploration pits and in situ tests; the types and frequency of samples obtained; the dates when the field investigation was performed; the subcontractors used to perform the work; the types and number of laboratory tests performed; the testing standards used; and any variations from conventional procedures.
3. *Data Presentation:* This portion of the report, generally contained in appendices, presents the data obtained from the field investigation and laboratory testing program, and typically includes final logs of all borings, exploration pits, and piezometer or well installations, water level readings, data plots from each in-situ test hole, summary tables and individual data sheets for all laboratory tests performed, rock core photographs, geologic mapping data sheets and summary plots, subsurface profiles developed from the field and laboratory test data, as well as statistical summaries. Often, the investigation report will also include copies of existing information such as boring logs or laboratory test data from previous investigations at the project site.

The intent of a geotechnical investigation report should be to document the investigation performed and present the data obtained. The report should include a summary of the subsurface and lab data.

Interpretation and recommendations on the index and design properties of soil and rock should also be included. This type of report typically does not include interpretations of the subsurface conditions and design recommendations. The geotechnical investigation report is sometimes used when the field investigations are subcontracted to a geotechnical consultant, but the data interpretation and design tasks are to be performed by the owner's or the prime consultant's in-house geotechnical staff. An example *Table of Contents* for a geotechnical investigation report is presented in Figure 11-1.

### 11.1.2 Geotechnical Design Reports

A geotechnical design report typically provides an assessment of existing subsurface conditions at a project site, presents, describes and summarizes the procedures and findings of any geotechnical analyses performed, and provides appropriate recommendations for design and construction of foundations, earth retaining structures, embankments, cuts, and other required facilities. Unless a separate investigation (data) report has previously been developed, the geotechnical design report will also include documentation of any subsurface investigations performed and a presentation of the investigation data as described in Section 11.1.1. An example *Table of Contents* for a geotechnical design report is presented in Figure 11-2.

Since the scope, site conditions, and design/construction requirements of each project are unique, the specific contents of a geotechnical design report must be tailored for each project. In order to develop this report, the author must possess detailed knowledge of the facility. In general, however, the geotechnical design report must address all the geotechnical issues that may be anticipated on a project. The report must identify each soil and rock unit of engineering significance, and must provide recommended design parameters for each of these units. This requires a summarization and analysis of all factual data to justify the recommended index and design properties. Groundwater conditions are particularly important for both design and construction and, accordingly, they need to be carefully assessed and described. For every project, the subsurface conditions encountered in the site investigation need to be compared with the geologic setting to better understand the nature of the deposits and to predict the degree of variability between borings.

Each geotechnical design issue must be addressed in accordance with the methodology described in subsequent modules of this training course, and the results of these studies need to be concisely and clearly discussed in the report. Of particular importance is an assessment of the impact of existing subsurface conditions on construction operations, phasing and timing. Properly addressing these items in the report can preclude change-of-conditions claims. Examples include but are not limited to:

- Vertical and lateral limits for recommended excavation and replacement of any unsuitable shallow surface deposits (peat, muck, top soil etc.);
- Excavation and cut requirements (i.e., safe slopes for open excavations or the need for sheeting or shoring);
- Anticipated fluctuation of groundwater table along with the consequences of high groundwater table on excavations;
- Effect of boulders on pile driveability or deep foundation drilling, and
- rock hardness on rippability.

Recommendations should be provided for solution of anticipated problems.

1.0	INTRODUCTION
2.0	SCOPE OF WORK
3.0	SITE DESCRIPTION
4.0	FIELD INVESTIGATION PROGRAM & IN-SITU TESTING
5.0	DISCUSSION OF LABORATORY TESTS PERFORMED
6.0	SITE CONDITIONS, GEOLOGIC SETTING, & TOPOGRAPHIC INFORMATION
7.0	SUMMARY OF SUBSURFACE CONDITIONS AND SOIL PROFILES
8.0	DISCUSSION OF FINDINGS, CONCLUSIONS, AND RECOMMENDATIONS
8.1	GENERAL
8.1.1	Subgrade & Foundation Soil/Rock Types
8.1.2	Soil/Rock Properties
8.2	GROUND WATER CONDITIONS/ OBSERVATIONS
8.3	SPECIAL TOPICS (i.e., dynamic properties, seismicity, environmental).
8.4	CHEMICAL ANALYSIS
9.0	FIELD PERMEABILITY TESTS
10.0	REFERENCES

LIST OF APPENDICES

- Appendix A - Boring Location Plan and Subsurface Profiles
- Appendix B - Test Boring Logs and Core Logs With Core Photographs
- Appendix C - Cone Penetration Test Soundings
- Appendix D - Flat Dilatometer, Pressuremeter, Vane Shear Test Results
- Appendix E - Geophysical Survey Data
- Appendix F - Field Permeability Test Data & Pumping Test Results
- Appendix G - Laboratory Test Results
- Appendix H - Existing Information

LIST OF FIGURES

LIST OF TABLES

**Figure 11-1. Example *Table of Contents* for a Geotechnical Investigation (Data) Report.**

1.0	INTRODUCTION
1.1	Project Description (Includes facility description, loads and performance requirements)
1.2	Scope of Work
2.0	GEOLOGY
2.1	Regional Geology
2.2	Site Geology
3.0	EXISTING GEOTECHNICAL INFORMATION
4.0	SUBSURFACE EXPLORATION PROGRAM
4.1	Subsurface Exploration Procedures
4.2	Laboratory Testing
5.0	SUBSURFACE CONDITIONS
5.1	Topography
5.2	Stratigraphy
5.3	Soil Properties
5.4	Groundwater Conditions
6.0	RECOMMENDATIONS FOR BRIDGE FOUNDATIONS
6.1	Design Alternatives
6.2	Group Effects
6.3	Foundation Settlement
6.4	Downdrag
6.5	Lateral Loading
6.6	Construction Considerations
6.7	Pile Testing
7.0	RECOMMENDATIONS FOR EARTH RETAINING STRUCTURES
7.1	Suitable Types
7.2	Design and Construction Considerations
8.0	ROADWAY RECOMMENDATIONS
8.1	Embankments and Embankment Foundations
8.2	Cuts
8.3	Pavement
9.0	SEISMIC CONSIDERATIONS
9.1	Seismicity
9.2	Seismic Hazard Criteria
9.3	Liquefaction Potential
10.0	CONSTRUCTION RECOMMENDATIONS
	<u>LIST OF REFERENCES</u>
	<u>LIST OF FIGURES</u>
	<u>APPENDICES</u>
	Appendix A Boring Logs
	Appendix B Laboratory Test Data
	Appendix C Existing Subsurface Information

**Figure 11-2. Example *Table of Contents* for a Geotechnical Design Report.**



The above issues are but a few of the items that need to be addressed in a geotechnical design report. To aid the engineers with review of geotechnical reports, FHWA has prepared review checklists and technical guidelines (FHWA, 1995). One of the primary purposes of the document is to set forth minimum geotechnical standards/criteria to show transportation agencies and consultants the basic geotechnical information which FHWA recommends be provided in geotechnical reports as well as plans and specification packages. Both technical guidelines for “minimum” site investigation information common to all geotechnical reports for any type of geotechnical feature and basic information and recommendations for specific geotechnical features are provided. Checklists are presented in the form of a question and answer format. Specific geotechnical features include:

- Centerline Cuts and Embankments;
- Embankments Over Soft Ground;
- Landslide Corrections;
- Retaining Walls;
- Structure Foundations (Spread Footings, Piles and Drilled Shafts);
- Borrow Material Sites.

### **11.1.3 GeoEnvironmental Reports**

When the geotechnical investigation indicates the presence of contaminants at the project site, the geotechnical engineer may be requested to prepare a geoenvironmental report outlining the investigation findings and making recommendations for the remediation of the site.

The preparation of such a report usually requires the geotechnical engineer to work with a team of experts, since many aspects of the contamination or the remediation may be beyond his/her expertise. A representative team preparing a geoenvironmental report may be composed of chemists, geologists, hydrogeologists, environmental scientists, toxicologists, air quality and regulatory experts, as well as one or more geotechnical engineers. The report should contain all of the components of the geotechnical investigation report, as discussed above. Additionally, it will have a clear and concise discussion of the nature and extent of contamination, the risk factors involved, if applicable, a contaminant transport model and, if known, the source of the contamination (i.e., landfill, industrial waste water line, broken sanitary sewer, above-ground or underground storage tanks, overturned truck or train derailment, or other).

The team may also be required to present solutions (i.e. removal of the contaminated material, pump and treat the groundwater, installation of slurry cut-off walls, or the abandonment of that portion of the right-of-way, deep soil mixing, bioremediation, electrokinetics) to remediate the site. The geoenvironmental report should also address the regulatory issues pertinent to the specific contaminants found and the proposed site remediation methods.

## **11.2 DATA PRESENTATION**

### **11.2.1 Boring Logs**

Boring logs, rock coring, soundings, and exploration logging should be prepared in accordance with the procedures and formats discussed in Chapters 3 through 5. Test boring logs and exploration test pit records can be prepared using software capable of storing, manipulating, and presenting geotechnical data in simple one-dimensional profiles, or alternatively two-dimensional graphs (subsurface profiles), or three-dimensional representations. These and other similar software allow the orderly storage of project data for future reference. The website: <http://www.ggsd.com> lists over 40 separate software packages available for preparation of soil boring logs.

For example, one software package in common use is *geotechnical INTEgrator*, or gINT (1994). The gINT program (<http://www.gcagint.com>) can be used to store subsurface exploration data, compute laboratory results, and produce boring logs, laboratory graphs, and tables. It has the capability for importing or exporting ASCII, .WKS, .DAT, and other file formats, including CAD software.

Many new software programs offer a menu-based boring log drafting program. The computer-aided drafting tools let users create custom boring log formats which can include graphic logs, monitoring well details, and data plots. Custom designed legends explaining graphic symbols and containing additional notes can be added to boring logs for greater clarity. These can include a library of soil types, sampler, and well symbols as well as other nomenclature used on boring logs. Geological profiles can be generated by the program and may be annotated with text and drawings.

Similarly, results of cone penetration tests (CPT) can be presented using available commercial software (e.g., CONELOT found at <http://www.civil.ubc.ca/home/in-situ/software.htm>) or from flat plate dilatometer tests (e.g., DMT DILLY software found at <http://www.gpe.org>). Other packages are available for reducing pressuremeter, vane, seismic cone, and piezocone data (<http://www.ggsd.com>). Links to many geotechnical software programs may be found at: <http://www.usucger.org>

Alternatively, it is convenient for the in-situ test data to be reduced directly and simply using a spreadsheet format (e.g., EXCEL, QUATTRO PRO, LOTUS 1-2-3). In many ways, the spreadsheet is a superior approach as it allows the engineer to individually tailor the interpretations to account for specific geologic settings and local formations. The spreadsheet also permits creativity and uniqueness in the graphical presentation of the results, thereby enhancing the abilities and resources available to the geotechnical personnel. Since soils and rocks are complex materials with enumerable variants and facets, a site-specific tailoring of the interpreted profiles and properties can be prudent.

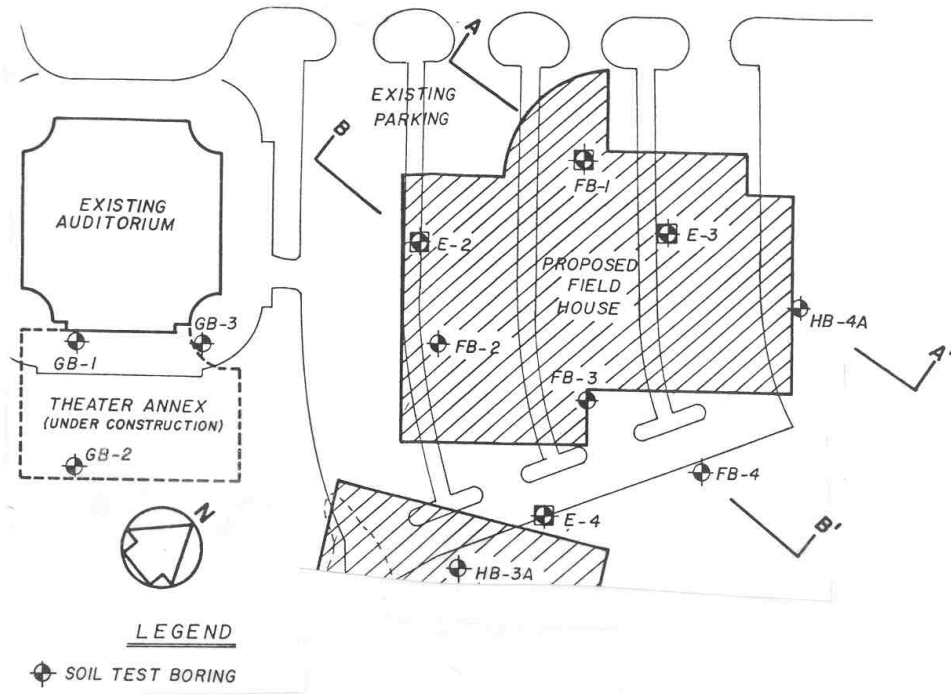
### **11.2.2 Test Location Plans**

A site location plan should be provided for reference on a regional or local scale. This can be handled via use of county or city street maps or USGS topographic quad maps. Topographic information at 20-foot (6-m) contour line intervals is now downloadable from the internet (e.g., [www.usgs.gov](http://www.usgs.gov)) or purchased for the entire United States from commercial suppliers (e.g., TopoUSA from [www.delorme.com](http://www.delorme.com)).

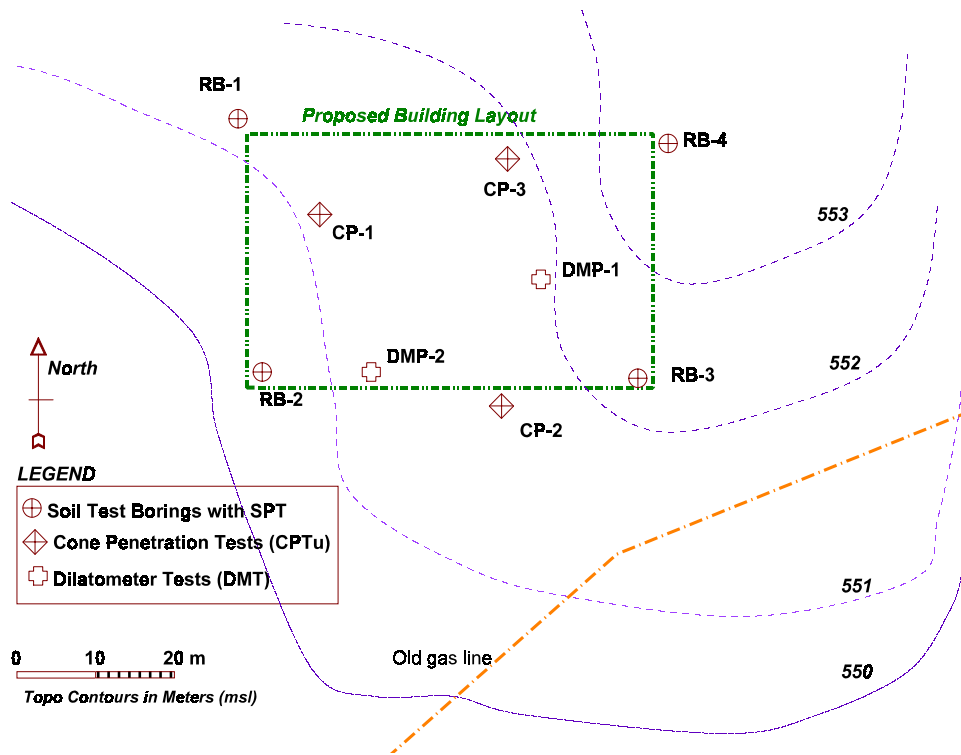
The locations of all field tests, sampling, and exploratory studies should be shown clearly on a scaled plan map of the specific site under investigation. Preferably, the plan should be a topographic map with well-delineated elevation contours and a properly-established benchmark. The direction of (magnetic or true) north should be shown. A representative example of a soil test boring location plan is given in Figure 11-3.

A *geographic information system* (GIS) can be utilized on the project to document the test locations in reference to existing facilities on the premises including any and all underground and above-ground utilities, as well as roadways, culverts, buildings, or other structures. Recent advances have been made in portable measuring devices that utilize *global positioning systems* (GPS) to permit quick & approximate determinations of coordinates of test locations and installations.

If multiple types of exploratory methods are used, the legend on the site test location plan should clearly show the different types of soundings. Figure 11-4 shows a proposed test location layout for a combination of soil test borings with SPT, cone penetration test (CPT) soundings, and flat plate dilatometer tests (DMT). A horizontal scale should be presented.



**Figure 11-3. Representative Test Location Plan of Completed Soil Boring Locations.**  
 (Note: Horizontal Scale: 1 cm = 10 meters)



**Figure 11-4. Plan Showing Proposed Boring and In-Situ Test Locations.**

### 11.2.3 Subsurface Profiles

Geotechnical reports are normally accompanied by the presentation of subsurface profiles developed from the field and laboratory test data. Longitudinal profiles are typically developed along the roadway or bridge alignment, and a limited number of transverse profiles may be included for key locations such as at major bridge foundations, cut slopes or high embankments. Such profiles provide an effective means of summarizing pertinent subsurface information and illustrating the relationship of the various investigation sites. The subsurface profiles, coupled with judgment and an understanding of the geologic setting, aid the geotechnical engineer in his/her interpretation of subsurface conditions between the investigation sites.

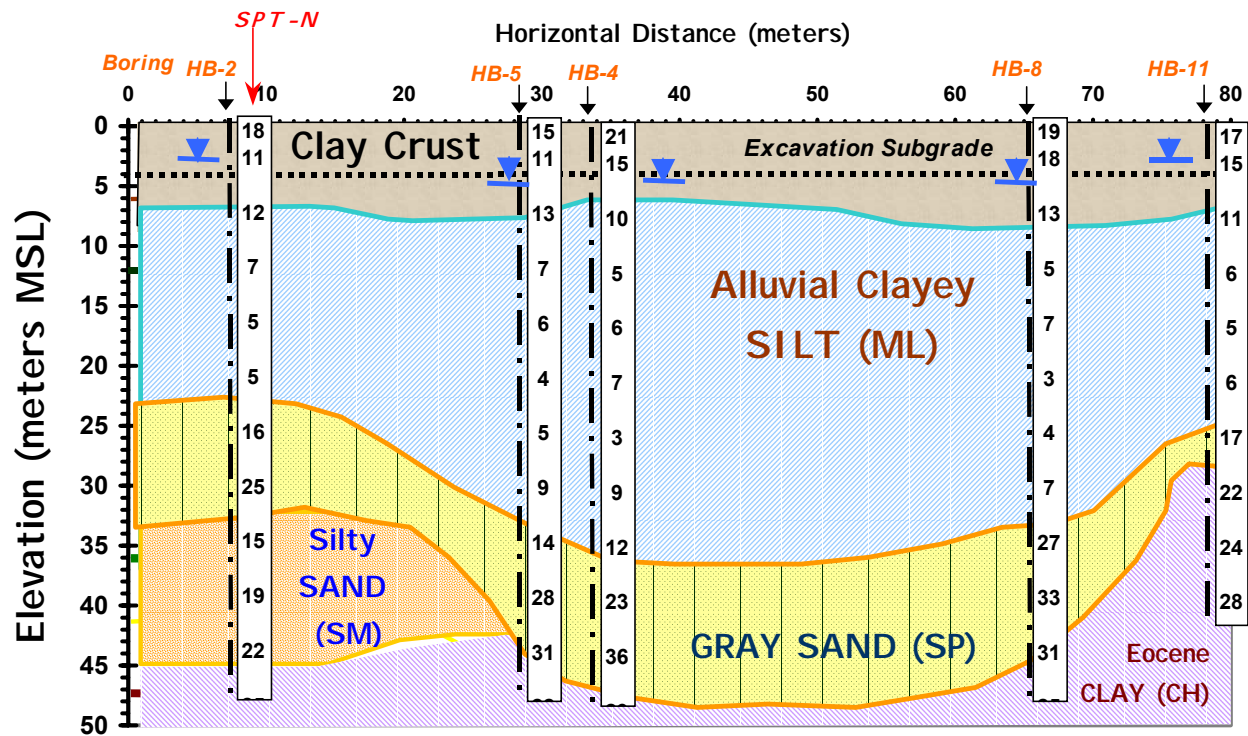


Figure 11-5. Subsurface Profile Based on Boring Data Showing Cross-Sectional View.

In developing a two-dimensional subsurface profile, the profile line (typically the roadway centerline) needs to be defined on the base plan, and the relevant borings projected to this line. Judgment should be exercised in the selection of the borings since projection of the borings, even for short distances, may result in misleading representation of the subsurface conditions in some situations.

The subsurface profile should be presented at a scale appropriate to the depth of the borings, frequency of the borings and soundings, and overall length of the cross-section. Generally, an exaggerated scale of 1(V):10(H) or 1(V):20(H) should be used. A representative example of an interpreted subsurface profile is shown in Figure 11-5.

The subsurface profile can be presented with reasonable accuracy and confidence at the locations of the borings. Generally, however, owners and designers would like the geotechnical engineer to present a continuous subsurface profile that shows an interpretation of the location, extent and nature of subsurface formations or deposits between borings. At a site where rock or soil profiles vary significantly between boring locations, the value of such presentations become questionable. The geotechnical engineer must be very cautious in presenting such data. Such presentations should include clear and simple caveats explaining that the profiles as presented cannot be fully relied upon. Should there be need to provide highly reliable continuous subsurface profiles, the geotechnical engineer should increase the frequency of borings and/or utilize geophysical methods to determine the continuity, or the lack of it, of subsurface conditions.

### **11.3 LIMITATIONS**

Soil and rock exploration and testing have inherent uncertainties. Thus the user of the data who may be unfamiliar with the variability of natural and manmade deposits should be informed in the report of the limitations inherent in the extrapolation of the limited subsurface information obtained from the site investigation. A typical statement, found in geotechnical reports prepared by consultants, that can be included in a geotechnical report is shown below.

“Professional judgments and recommendations are presented in this report. They are based partly on evaluation of the technical information gathered, partly on historical reports and partly on our general experience with subsurface conditions in the area. We do not guarantee the performance of the project in any respect other than that our engineering work and the judgment rendered meet the standards and care of our profession. It should be noted that the borings may not represent potentially unfavorable subsurface conditions between borings. If during construction soil conditions are encountered that vary from those discussed in this report or historical reports or if design loads and/or configurations change, we should be notified immediately in order that we may evaluate effects, if any, on foundation performance. The recommendations presented in this report are applicable only to this specific site. These data should not be used for other purposes.”

The reader is referred to a document entitled “Important Information About Your Geotechnical Engineering Report”, which is published by ASFE, The Association of Engineering Firms Practicing In The Geosciences [Phone No. (301) 565-2733]. This document presents suggestions for writing a geotechnical report and observations to help reduce the geotechnical-related delays, cost overruns and other costly headaches that can occur during a construction project.

AASHTO recommends the use of site-specific disclaimer clauses for DOT projects, particularly for construction bids and plans. Specific disclaimer clauses are preferred to the use of general disclaimer clauses which may not be enforceable. Examples of site-specific disclaimers is shown below.

“The boring logs for BAF-1 through BAF-4 are representative of the conditions at the location where each boring was made but conditions may vary between borings.”

“Although boulders in large quantities were not encountered on this site in the borings that are numbered BAF-1 through BAF-4, previous projects in this area have found large quantities of boulders. Therefore, the contractor should be expected to encounter substantial boulder quantities in excavations. The contractor should include any perceived extra costs for boulder removal in this area in his bid price for Item xxx.”

[Blank]

## CHAPTER 12.0

### CONTRACTING OF GEOTECHNICAL SUBSURFACE EXPLORATION

It is common practice with many agencies to outsource or contract drilling, in-situ testing, and laboratory testing programs to external sources. Whether the subsurface exploration work is performed by the agency itself or by others, it is ultimately the geotechnical engineer's responsibility to assure the appropriateness of the exploration and testing procedures. Thus, it is essential to scrutinize the qualifications, quality control, and quality assurance procedures, the equipment and personnel, the professional reputation, and the safety record of the contractor, consultant, or testing firm.

On some projects, a fulltime on-site inspector from the Owner who is technically-qualified should be present during drilling, sampling, & field testing to confirm and document the events and results. On small projects, periodic visits to observe these tasks and operations should be made by the geotechnical engineer. A visit to the testing laboratory (who may be separate from the contract driller or service company) should also be made to check sample handling and storage procedures, and the setup of triaxial, direct shear, consolidometer, permeameters, resonant column, and other devices. The general operating condition of the mechanical, electrical, hydraulic, and/or pneumatic components should be inspected and the most recent calibration curves inspected for verification that a QC/QA program has been undertaken by the testing laboratory. It should be noted that a minimum recommended QC/QA program does not exist and that the extent, scope, and quality of these programs vary greatly. Unfortunately, many public owners do not require QC/QA criteria for drilling, in-situ testing, or laboratory testing which is performed by outside contractors.

#### 12.1 DRILLING AND TESTING SPECIFICATIONS

Testing and drilling specifications should be prepared by the geotechnical engineer and the geologist. They should, as a minimum, contain clear concise statements and descriptions of the following items:

For drilling/coring:

- ' Type of the project (e.g., embankment, bridge, wall, cut slope)
- ' Location of the project
- ' Site access information
- ' Site access problems- if known
- ' Drilling site survey and borehole location information
- ' Contaminants- if applicable
- ' Special health and safety requirements
- ' Site map and topographic data
- ' Preliminary plans, if available
- ' Types of samples to be obtained
- ' Standards to be followed (ASTM, local, others)
- ' Type of equipment to be used
- ' Environmental constraints
- ' Minimum drilling/coring crew size
- ' Qualifications of the field supervisor (i.e. field geologist, engineer)
- ' Identification of who will supervise the boring/coring operations
- ' Procedures to be followed to transport samples
- ' Destination of the samples

- ' Frequency of shipping of samples
- ' Name, phone number and address of the geotechnical engineer or geologist in charge
- ' Nature and number of field tests to be performed

If the contract is for drilling, coring, sampling, & testing, the following items should be included in the information provided to the contractor:

- ' The types of drilling methods to be used
- ' Field methods and in-situ tests to be conducted
- ' Types & quantities of tests to be performed
- ' Testing standards to be followed (ASTM, AASHTO, Local)
- ' Laboratory QA/QC procedures or requirements
- ' Reporting formats and presentation of data
- ' Contents of the geotechnical report

Each request for proposal for a subsurface exploration should also contain a realistic & flexible schedule to be reviewed and accepted by the contractor. The drilling contractor should be required to provide a formal document outlining its health and safety program. Additionally, the contractor should provide the number of accidents resulting in man days lost during the previous year, as well as its insurance rating.

The contractual terms, including payments for services, liability, indemnity, failure to complete the job, etc. are normally covered by each agency's procurement or contracting office. The agency should always reserve the right to review the progress of the work and to provide on site supervision of drilling, field testing, or laboratory testing. Prior to accepting a contractor for a given project the geotechnical engineer and/or the geologist should perform an on site and paper review of the contractor's capabilities. A practice which may be considered as an integral part of the traditional advertising and selection process of contractors, is the review of the facilities, equipment and experience of the top two or three selected contractors prior to awarding a blanket or specific contract.



**Figure 12-1. Track-Mounted Drill Rig Investigating Bridge Site in Hayti, Missouri.**



## CHAPTER 13

### REFERENCES

- Acker, W. L., III (1974). *Basic Procedures for Soil Sampling and Core Drilling*, Acker Drill Co. Inc., P.O. Box 830, Scranton, PA., 18501.
- ADSC (1995). "Recommended procedures for the entry of drilled shaft foundations excavations." The International Association of Foundation Drilling, (IAFD-ADSC), Dallas.
- American Association of State Highway and Transportation Officials (AASHTO) (1988). *Manual on Subsurface Investigations*, Developed by the Subcommittee on Materials, Washington, D.C.
- American Association of State Highway and Transportation Officials (AASHTO). (1995). *Standard specifications for transportation materials and methods of sampling and testing: part II: tests*, Sixteenth Edition, Washington, D.C.
- American Society for Testing & Materials. (2000). *ASTM Book of Standards, Vol. 4, Section 08 and 09, Construction Materials: Soils & Rocks*, Philadelphia, PA.
- Baguelin, F., Jezequel, J. F., and Shields, D. H. (1978). *The Pressuremeter and Foundation Engineering*, Trans Tech Publication, Switzerland.
- Baldi, G., Bellotti, R., Ghionna, V., Jamiolkowski, M. and LoPresti, D.C. (1989). "Modulus of sands from CPTs and DMTs", *Proceedings, 12<sup>th</sup> International Conference on Soil Mechanics & Foundation Engineering*, Vol. 1, Rio de Janeiro, 165-170.
- Barton, N.R. (1973). "Review of a new shear strength criterion for rock joints." *Engineering Geology*, Elsevier, Vol. 7, 287-332.
- Barton, N.R., Lien, R., and Lunde, J. (1974). "Engineering classification of rock masses for the design of tunnel support". *Rock Mechanics*, Vol. 6 (4), 189-239.
- Barton, N.R. (1988). "Rock mass classification and tunnel reinforcement using the Q-system.", *Rock Classification Systems for Engineering Purposes*, STP No. 984, ASTM, West Conshohocken, PA, 59-84.
- Bieniawski, Z.T. (1984). *Rock Mechanics Design in Mining and Tunneling*. Balkema, Rotterdam, 272 p.
- Bieniawski, Z. T. (1989). *Engineering Rock Mass Classifications*, John Wiley & Sons, Inc., New York.
- Bieniawski, Z. T. (1972). "Propagation of brittle fracture in rock." *Proceedings, 10th U.S. Symposium on Rock Mechanics*, Johannesburg, South Africa.
- Bishop, A. W., and Henkel, D. J. (1962). *The Measurement of Soil Properties in the Triaxial Test*, Second Edition, Edward Arnold Publishers, Ltd., London, U.K., 227 p.
- Bishop, A. W., and Bjerrum, L. (1960). "The relevance of the triaxial test to the solution of stability problems." *Proceedings, Research Conference on Shear Strength of Cohesive Soils*, Boulder/CO, ASCE, 437-501.
- Bishop, A. W., Alpan, I., Blight, G.E., and Donald, I.B. (1960). "Factors controlling the strength of partially saturated cohesive soils.", *Proceedings, Research Conference on Shear Strength of Cohesive Soils*, Boulder/CO, ASCE, 503-532.
- Bjerrum, L. (1972). "Embankments on soft ground." *Proceedings, Performance of Earth and Earth-Supported Structures*, Vol. II, (Purdue Univ. Conf.), ASCE, Reston/VA, 1-54.
- Bolton, M.D. (1986). "The strength and dilatancy of sands", *Geotechnique*, Vol. 36 (1), 65-78.
- Briaud, J. L. (1989). "The pressuremeter test for highway applications." *Report FHWA-IP-89-008*, Federal Highway Administration, Washington, D.C., 148.
- Bruce, D. A., Xanthakos, P. P., and Abramson, L. W. (1994). "Jet grouting", *Ground Control and Improvement*, Chapter 8, 580-683.
- Burland, J.B. (1989), "Small is beautiful: The stiffness of soils at small strains", *Canadian Geotechnical Journal*, Vol. 26 (4), 499-516.

- Burmister, D. M. (1970). "Suggested methods for identification of soils." *Special Procedures for Testing Soil and Rock for Engineering Purposes*, Special Technical Publication 479, ASTM, West Conshohocken, PA, 311-23.
- Burns, S.E. and Mayne, P.W. (1996). "Small- and high-strain measurements of in-situ soil properties using the seismic cone". *Transportation Research Record 1548*, Natl. Acad. Press, Wash., D.C., 81-88.
- Burns, S.E. and Mayne, P.W. (1998). "Monotonic and dilatatory pore pressure decay during piezocone tests". *Canadian Geotechnical Journal*, Vol. 35 (6), 1063-1073.
- Cambefort, H. (1964). "Injection des sols: tome 1." *Principes et Methodes*, Paris, France (in French).
- Campanella, R.G. (1994). "Field methods for dynamic geotechnical testing", *Dynamic Geotechnical Testing II* (STP 1214), ASTM, Philadelphia, 3-23.
- Campanella, R. G., and Robertson, P. K. (1981). "Applied cone research", *Cone Penetration Testing and Experience*, ASCE, Reston/VA, 343-362.
- Carter, M., and Bentley, S. P. (1991). *Correlations of Soil Properties*, Pentech Press Limited, London, U.K.
- Casagrande, A., and Fadum, R. E. (1940). "Notes on soil testing for engineering purposes." *Publication 268*, Graduate School of Engineering, Harvard University, Cambridge, Ma.
- Chandler, R.J. (1988). "The in-situ measurement of the undrained shear strength of clays using the field vane". *Vane Shear Strength Testing in Soils: Field and Laboratory Studies*. ASTM STP 1014, American Society for Testing & Materials, West Conshohocken/PA, 13-44.
- Chen, B.S-Y. and Mayne, P.W. (1996). "Statistical relationships between piezocone measurements and stress history of clays". *Canadian Geotechnical Journal*, Vol. 33 (3), 488-498.
- Cheney, R. S., and Chassie, R. G. (1993). "Soils and foundations workshop manual." *Circular FHWA: HI-88-009*, Federal Highway Administration, Washington D.C., 399.
- Clarke, B.G. (1995). *Pressuremeters in Geotechnical Design*. International Thomson Publishing/UK, and BiTech Publishers, Vancouver.
- Das, B. M. (1987). *Advanced Soil Mechanics*, McGraw-Hill Company, New York.
- Das, B. M. (1990). *Principles of Geotechnical Engineering*, PWS-Kent Publishing Company, Boston, MA, 665 p.
- Deere, D. U., and Deere, D. W. (1989). Report Manual: *Rock quality designation (RQD) after 20 years*. Contract DACW39-86-M-4273, Department of the Army, U.S. Army Corps of Engineers, Washington, D.C.
- Deere, D. U., and Miller, R. P. (1966). *Engineering classification and index properties of intact rock*, Tech. Report. No. AFWL-TR-65-116, USAF Weapons Lab., Kirtland Air Force Base, NM.
- Deere, D. U. (1963). "Technical description of rock cores for engineering purposes." *Felmechanik und Ingenieur Geologis*, 1 (1), 16-22.
- Driscoll, F. G. (1986). *Groundwater and Wells, 2nd Edition*, Johnson Filtration Systems, Inc., St. Paul, MN, 1089 p.
- Duncan, J.M. and Chang, C.Y. (1970). "Nonlinear analysis of stress and strain in soils". *Journal of the Soil Mechanics & Foundation Division* (ASCE) 96 (SM5), 1629-1653.
- Dunnicliff, J. (1988). *Geotechnical Instrumentation for Monitoring Field Performance*, John Wiley & Sons, Inc., New York.
- Fahey, M. and Carter, J.P. (1993). "A finite element study of the pressuremeter in sand using a nonlinear elastic plastic model", *Canadian Geotechnical Journal*, Vol. 30 (2), 348-362.
- Federal Highway Administration (FHWA). (1985) "Checklist and guidelines for review of geotechnical reports and preliminary plans and specifications." *Report FHWA-ED-88-053*, Washington D.C.
- Federal Highway Administration (FHWA). (1989). "Rock slopes: design, excavation, stabilization." *Circular No. FHWA: TS-89-045*, Washington, D.C.
- Finn, P. S., Nisbet, R. M., and Hawkins, P. G. (1984). "Guidance on pressuremeter, flat dilatometer and cone penetration tests in sand." *Géotechnique*, Vol. 34 (1), 81-97.

- Ford, P.J., Turina, P.J., and Seely, D.E. (1984). *Characterization of hazardous waste sites - a methods manual: vol. II, available sampling methods*, 2nd Edition, EPA 600/4-84-076 (NTIS PB85-521596). Environmental Monitoring Systems Laboratory, Las Vegas, NV.
- Foster, R. S. (1975). *Physical Geology*, Merrill Publishing, Columbus, OH.
- Franklin, J. A., and Dusseault, M. B. (1989). *Rock Engineering*, McGraw-Hill Company, New York.
- Franklin, J. A. (1981). "A shale rating system and tentative applications to shale performance." *Shales and Swelling Soils, Transportation Research Record 790*, Transportation Research Board, Washington D.C.
- Gibson, R. E. (1953). "Experimental determination of the true cohesion and true angle of internal friction in clays." *Proceedings, 3rd International Conference on Soil Mechanics and Foundation Engineering*, Zurich, Switzerland, 126-130.
- gINT - gEotechnical INTegrator Software 3.2. (1991). "gINT, gEotechnical INTegrator Software 3.2, Documentation." *Geotechnical Computer Applications, Inc.*, Santa Rosa, California.
- Goodman, R. E. (1989). *Introduction to Rock Mechanics*, Second Edition, John Wiley & Sons, Inc., New York, 562 p.
- Greenhouse, J.P., Slaine, D.D., and Gudjurgis, P. (1998). *Application of Geophysics in Environmental Investigations*, Matrix Multimedia Publishing, Toronto.
- Hardin, B.O. and Drnevich, V.P. (1972). "Shear modulus and damping in soils". *Journal of the Soil Mechanics & Foundation Division (ASCE)*, Vol. 98 (SM7), 667-692.
- Hassani, F.P., and Scoble, M.J. (1985). "Frictional mechanism and properties of rock discontinuities." *Proceedings, International Symposium on Fundamentals of Rock Joints*, Björkliden, Sweden, 185-196.
- Hatanaka, M. and Uchida, A. (1996). "Empirical correlation between penetraion resistance and effective friction of sandy soil", *Soils & Foundations*, Vol. 36 (4), Japanese Geotechnical Society, 1-9.
- Hegazy, Y.A. (1998). Delineating geostratigraphy by cluster analysis of piezocone data. *PhD Thesis*, School of Civil and Environmental Engineering, Georgia Institute of Technology, Atlanta, 464 p.
- Hilf, J. W. (1975). "Compacted fill." *Foundation Engineering Handbook*, H. F. Winterkorn and H. Y. Fang, eds., Van Nostrand Reinhold, New York, 244-311..
- Hoar, R.J. and Stokoe, K.H. (1978), "Generation and measurement of shear waves in-situ", *Dynamic Geotechnical Testing (STP 654)*, ASTM, Philadelphia, 3-29.
- Hoek, E., and Bray, J. W. (1977). *Rock Slope Engineering*, Institution of Mining and Metallurgy, London, U.K.
- Hoek, E., Kaiser, P.K., and Bawden, W.F. (1995). *Support of Underground Excavations in Hard Rock*, A.A. Balkema, Rotterdam, Netherlands.
- Hoek, E. and Brown, E.T. (1998). "Practical estimates of rock mass strength", *International Journal of Rock Mechanics & Min. Sciences*, Vol. 34 (8), 1165-1186.
- Holtz, W. G., and Gibbs, H. J. (1979). Discussion of "SPT and relative density in coarse sand." *Journal of Geotechnical Engineering*, ASCE, Vol. 105 (3), 439-441.
- Holtz, R. D., and Kovacs, W. D. (1981). *An Introduction to Geotechnical Engineering*, Prentice-Hall, Inc., Englewood Cliffs, NJ.
- Hough, B. K. (1969). *Basic Soils Engineering*, Ronald Press, New York.
- Houlsby, G.T. and Teh, C.I. (1988). "Analysis of the piezocone in clay", *Penetration Testing 1988*, Vol. 2, Balkema, Rotterdam, 777-783.
- Hunt, R. E. (1984). *Geotechnical Engineering Investigation Manual*, McGraw-Hill Inc., 983 p.
- Hvorslev, M. J. (1948). *Subsurface Exploration and Sampling of Soils for Civil Engineering Purposes*, U.S. Army Corps of Engineers, Waterways Experiment Station, Vicksburg, MS.
- International Society for Rock Mechanics Commission (1979). "Suggested Methods for Determining Water Content, Porosity, Density, Absorption and Related Properties." *International Journal Rock Mechanics. Mining Sci. and Geomechanics Abstr.*, Vol. 16, Great Britian, 141-156.

- Jaeger, J.C. and Cook, N.G.W. (1977). *Fundamentals of Rock Mechanics*, 2nd Edition, Science Paperbacks, Chapman & Hall, London, 585 p.
- Jamiolkowski, M., Ladd, C. C., Germaine, J. T., and Lancellotta, R. (1985). "New developments in field and laboratory testing of soils." *Proceedings, 11<sup>th</sup> International Conference on Soil Mechanics & Foundation Engineering*, Vol. 1, San Francisco, 57-153.
- Jamiolkowski, M., Lancellotta, R., LoPresti, D.C.F., and Pallara, O. (1994). "Stiffness of Toyoura sand at small and intermediate strains". *Proceedings, 13<sup>th</sup> International Conference on Soil Mechanics & Geotechnical Engineering* (1), New Delhi, 169-172.
- Keaveny, J. and Mitchell, J.K. (1986). "Strength of fine-grained soils using the piezocone". *Use of In-Situ Tests in Geotechnical Engineering*, GSP 6, ASCE, Reston/VA, 668-685.
- Kovacs, W.D., Salomone, L.A., and Yokel, F.Y. (1983). "Energy Measurements in the Standard Penetration Test." *Building Science Series 135*, National Bureau of Standards, Washington, 73.
- Krebs, R. D., and Walker, E. D. (1971). "Highway materials." *Publication 272*, Department of Civil Engng., Massachusetts Institute of Technology, McGraw-Hill Company, New York, 107.
- Kulhawy, F.H. (1975). "Stress-deformation properties of rock and rock discontinuities", *Engineering Geology*, Vol. 9, 327-350.
- Kulhawy, F.H. and Mayne, P.W. (1990). Manual on Estimating Soil Properties for Foundation Design. *Report EPRI-EL 6800*, Electric Power Research Institute, Palo Alto, 306 p.
- Kulhawy, F.H. and Mayne, P.W. (1991). Relative density, SPT, and CPT interrelationships. *Calibration Chamber Testing*, (Proceedings, ISOCCT, Potsdam), Elsevier, New York, 197-211.
- Kulhawy, F.H., Trautmann, C.H., and O'Rourke, T.D. (1991). "The soil-rock boundary: What is it and where is it?". *Detection of and Construction at the Soil/Rock Interface*, GSP No. 28, ASCE, Reston/VA, 1-15.
- Kulhawy, F.H. and Phoon, K.K. (1993). "Drilled shaft side resistance in clay soil to rock", *Design and Performance of Deep Foundations: Piles & Piers in Soil & Soft Rock*, GSP No. 38, ASCE, Reston/VA, 172-183.
- Ladd, C.C., and Foott, R. (1974). "A new design procedure for stability of soft clay." *Journal of Geotechnical Engineering*, ASCE, Vol. 100 (3), 763-786.
- Ladd, C.C. (1991). Stability evaluation during staged construction. *ASCE Journal of Geotechnical Engineering* 117 (4), 540-615.
- Lambe, T.W. (1967). "The Stress Path Method." *Journal of the Soil Mechancis and Foundation Division*, ASCE, Vol. 93 (6), Proc. Paper 5613, 309-331.
- Lambe, T.W. and Marr, A.M. (1979). "Stress Path Method: Second Edition," *Journal of Geotechnical Engineering*, ASCE, Vol. 105 (6), 727-738.
- Lambe, T. W., and Whitman, R. V. (1979). *Soil Mechanics: SI Version*, John Wiley & Sons, Inc., New York, 553 p.
- Lame, G. (1852). *Lecons sur la theorie mathematique d'elasticite des corps solides*, Bachelier, Paris, France (in French).
- Leroueil, S. and Jamiolkowski, M. (1991). "Exploration of soft soil and determination of design parameters", *Proceedings, GeoCoast'91*, Vol. 2, Port & Harbor Res. Inst., Yokohama, 969-998.
- Littlechild, B.D., Hill, S.J., Statham, I., Plumbridge, G.D. and Lee, S.C. (2000). "Determination of rock mass modulus for foundation design", *Innovations & Applications in Geotechnical Site Characterization* (GSP 97), ASCE, Reston, Virginia, 213-228.
- LoPresti, D.C.F., Pallara, O., Lancellotta, R., Armandi, M., and Maniscalco, R. (1993). "Monotonic and cyclic loading behavior of two sands at small strains". *ASTM Geotechnical Testing Journal*, Vol. 16 (4), 409-424.
- LoPresti, D.C.F., Pallara, O., and Puci, I. (1995). "A modified commercial triaxial testing system for small-strain measurements". *ASTM Geotechnical Testing Journal*, Vol. 18 (1), 15-31.

- Lowe III, J., and Zaccheo, P.F. (1991). "Subsurface explorations and sampling." *Foundation Engineering Handbook*, H. Y. Fang, ed., Van Nostrand Reinhold, New York, 1-71.
- Lunne, T., Powell, J.J.M., Hauge, E.A., Mokkelbost, K.H., and Uglow, I.M. (1990). "Correlation for dilatometer readings with lateral stress in clays", *Transportation Research Record* 1278, National Academy Press, Washington, D.C., 183-193.
- Lunne, T., Lacasse, S., and Rad, N.S. (1994). "General report: SPT, CPT, PMT, and recent developments in in-situ testing". *Proceedings*, 12<sup>th</sup> International Conference on Soil Mechanics & Foundation Engineering, Vol. 4, Rio de Janeiro, 2339-2403.
- Lunne, T., Robertson, P.K., and Powell, J.J.M. (1997). *Cone Penetration Testing in Geotechnical Practice*, Blackie-Academic Publishing/London, EF SPON Publishing, U.K., 317 p.
- Lupini, J.F., Skinner, A.E., and Vaughan, P.R. (1981). "The drained residual strength of cohesive soils", *Geotechnique*, Vol. 31 (2), 181-213.
- Lutenegger, A. J., DeGroot, D. J., Mirza, C., and Bozozuk, M. (1995). "Recommended guidelines for sealing geotechnical exploratory holes." *FHWA Report 378*, Federal Highway Administration Washington, D.C.
- Mair, R. J., and Wood, D. M. (1987). "Pressuremeter testing methods and interpretation." *Ground Engineering Report: In-Situ Testing*, (CIRIA), Butterworths, London, U.K.
- Marchetti, S. (1980). "In-situ tests by flat dilatometer", *Journal of the Geotechnical Engineering Division (ASCE)*, Vol. 107 (3), 832-837.
- Marchetti, S. (1997). "The flat dilatometer: design applications", *Proceedings, Third International Geotechnical Engineering Conference*, Cairo University, Egypt, 1-25.
- Marcuson, W.F. and Bieganousky, W.A. (1977). "SPT and relative density in coarse sands", *Journal of the Geotechnical Engineering Division (ASCE)*, Vol. 103 (GT11), 1295-1309.
- Mayne, P.W. and Kulhawy, F.H. (1982). "K<sub>0</sub>-OCR relationships in soil". *Journal of Geotechnical Engineering*, Vol. 108 (GT6), 851-872.
- Mayne, P. W., and Mitchell, J. K. (1988). "Profiling of overconsolidation ratio in clays by field vane." *Canadian Geotechnical Journal*, Vol. 25 (1), 150-158.
- Mayne, P.W., Kulhawy, F.H., and Kay, J.N. (1990). "Observations on the development of pore water pressures during piezocone tests in clays". *Canadian Geotechnical Journal*, Vol. 27 (4), 418-428.
- Mayne, P.W. and Kulhawy, F.H. (1990). "Direct & indirect determinations of in-situ K<sub>0</sub> in clays." *Transportation Research Record* 1278, National Academy Press, Washington, D.C., 141-149.
- Mayne, P.W. (1991). "Determination of OCR in clays by piezocone tests using cavity expansion and critical state concepts." *Soils and Foundations*, Vol. 31 (2), 65-76.
- Mayne, P.W. and Rix, G.J. (1993). "G<sub>max</sub>-q<sub>c</sub> relationships for clays", *ASTM Geotechnical Testing Journal*, Vol. 16 (1), 54-60.
- Mayne, P.W., Mitchell, J.K., Auxt, J., and Yilmaz, R. (1995). "U.S. national report on the CPT". *Proceedings, International Symposium on Cone Penetration Testing (CPT'95)*, Vol. 1, Swedish Geotechnical Society, Linköping, 263-276.
- Mayne, P.W. (1995). "Profiling yield stresses in clays by in-situ tests". *Transportation Research Record* 1479, National Academy Press, Washington, D.C., 43-50.
- Mayne, P.W. (1995). "CPT determination of OCR and K<sub>0</sub> in clean quartz sands". *Proceedings, CPT'95*, Vol. 2, Swedish Geotechnical Society, Linköping, 215-220.
- Mayne, P.W., Robertson, P.K., and Lunne, T. (1998). "Clay stress history evaluated from seismic piezocone tests". *Geotechnical Site Characterization*, Vol. 2, Balkema, Rotterdam, 1113-1118.
- Mayne, P.W. and Martin, G.K. (1998). "Commentary on Marchetti flat dilatometer correlations in soils." *ASTM Geotechnical Testing Journal*, Vol. 21 (3), 222-239.
- Mayne, P.W., Schneider, J.A., and Martin, G.K. (1999). "Small- and large-strain soil properties from seismic flat dilatometer tests", *Pre-Failure Deformation Characteristics of Geomaterials*, Vol. 1 (Torino), Balkema, Rotterdam, 419-426.

- Mayne, P.W. (2001). "Stress-strain-strength-flow parameters from enhanced in-situ tests", *Proceedings, International Conference on In-Situ Measurement of Soil Properties & Case Histories (In-Situ 2001)*, Bali, Indonesia, 47-69.
- Mesri, G. and Abdel-Ghaffar, M.E.M. (1993). "Cohesion intercept in effective stress stability analysis". *Journal of Geotechnical Engineering* 119 (8), 1229-1249.
- Mitchell, J.K. (1993). *Fundamentals of Soil Behavior, Second Edition*, John Wiley & Sons, New York, 437 p.
- NAVFAC, P-418. (1983). "Dewatering and groundwater control." *Naval Facilities Engineering Command, Department of the Navy; Publication No. TM 5-818-5*.
- NAVFAC, DM-7.1. (1982). "Soil Mechanics." Naval Facilities Engineering Command, Department of the Navy, Alexandria, VA.
- Ng, C.W.W., Yau, T.L.Y., Li, J.H.M, and Tang, W.H. (2001). "Side resistance of large diameter bored piles socketed into decomposed rocks", *Journal of Geotechnical & Geoenvironmental Engineering* Vol. 127 (8), 642-657.
- Obert, L., and Duvall, W. I. (1967). *Rock Mechanics and the Design of Structures in Rock*, John Wiley & Sons, Inc., New York.
- Ohta, H., Nishihara, A., and Morita, Y. (1985). "Undrained stability of  $K_0$ -consolidated clays." *Proceedings, 11<sup>th</sup> International Conference on Soil Mechanics & Foundation Engineering*, Vol. 2, San Francisco, 613-616.
- Parez, L. and Faureil, R. (1988). "Le piézocône. Améliorations apportées à la reconnaissance de sols". *Revue Française de Géotech*, Vol. 44, 13-27.
- Patton, F. D. (1966). "Multiple modes of shear failure in rock." *Proc., 1st International Congress on Rock Mechanics*, Lisbon, Portugal, 509-13.
- Peck, R. B., Hansen, W. E., and Thornburn, T. H. (1974). *Foundation Engineering*, John Wiley & Sons, Inc., New York, 514 p.
- Pough, F.H. (1988). *Rocks & Minerals*. The Peterson Field Guide Series, Houghton Mifflin Company, Boston, 317 p.
- Poulos, S.J. (1988). "Compaction control and the index unit weight". *ASTM Geotechnical Testing Journal*, Vol. 11, No. 2, 100-108.
- Powers, J. P. (1992). *Construction Dewatering*, John Wiley & Sons, Inc., New York.
- Puzrin, A.M. and Burland, J.B. (1996). "A logarithmic stress-strain function for rocks and soils." *Geotechnique*, Vol. 46 (1), 157-164.
- Rehm, B.W., Stolzenburg, T. R., and Nichols, D. G. (1985). "Field measurement methods for hydrogeologic investigations: a critical review of the literature." *EPRI Report No. EA-4301*, Electric Power Research Institute, Palo Alto, CA.
- Richart, F. E. Jr. (1977). "Dynamic stress-strain relations for soils - State of the art report." *Proceedings, 9<sup>th</sup> International Conference on Soil Mechanics and Foundation Engineering*, Tokyo, 605-612.
- Robertson, P.K. and Campanella, R.G. (1983). "Interpretation of cone penetration tests: Part I - sands; Part II - clays". *Canadian Geotechnical Journal*, Vol. 20 (4), 719-745.
- Robertson, P.K., Campanella, R.G., and Wightman, A. (1983). "SPT-CPT correlations", *Journal of the Geotechnical Engineering Division (ASCE)*, Vol. 109 (11), 1449-1459.
- Robertson, P.K. (1986). "In-situ testing and its application to foundation engineering", *Canadian Geotechnical Journal*, Vol. 23 (4), 573-584.
- Robertson, P.K., Campanella, R.G., Gillespie, D., and Grieg, J. (1986). "Use of piezometer cone data". *Use of In-Situ Tests in Geotechnical Engineering*, GSP No. 6, ASCE, New York, 1263-1280.
- Robertson, P.K., Campanella, R.G., Gillespie, D., and Rice, A. (1986). "Seismic CPT to measure in-situ shear wave velocity". *Journal of Geotechnical Engineering* 112 (8), 71-803.
- Robertson, P.K., Campanella, R.G., Gillespie, D. and By, T. (1988). "Excess pore pressures and the flat dilatometer test", *Penetration Testing 1988*, Vol. 1, Balkema, Rotterdam, 567-576.

- Robertson, P.K. (1990). "Soil classification using the cone penetration test". *Canadian Geotechnical Journal*, Vol. 27 (1), 151-158.
- Santamarina, J.C., Klein, K. and Fam, M.A. (2001). *Soils and Waves, Particulate Materials Behavior, Characterization, & Process Monitoring*, John Wiley & Sons, Ltd., New York, 488 p.
- Schmertmann, J.H. (1986). "Suggested method for performing the flat dilatometer test", *ASTM Geotechnical Testing Journal*, Vol. 9 (2), 93-101.
- Serafim, J. L. and Pereira, J. P. (1983). "Considerations of the geomechanics classification of Bieniawski." *Proceedings, International Symposium on Engineering Geology and Underground Construction*, Lisbon, 1133-44.
- Sheorey, P.R. (1997). *Empirical Rock Failure Criteria*. A.A. Balkema, Rotterdam, 176 p.
- Singh, B. and Goel, R.K. (1999). *Rock Mass Classification: A practical approach in civil engineering*. Elsevier Science Ltd., Oxford, U.K., 267 p.
- Skempton, A. W. (1957). Discussion on "The planning and design of new Hong Kong airport." *Proceedings, Institution of Civil Engineers*, Vol. 7 (3), London, 305-307.
- Skempton, A.W. (1986). "SPT procedures and the effects in sands of overburden pressure, relative density, particle size, aging, and overconsolidation". *Geotechnique*, Vol. 36, No. 3, 425-447.
- Soil Conservation Service (SCS). (1983). *National soils handbook*, Information Division, Washington, D.C.
- Sowers, G.F. (1979). *Introductory Soil Mechanics and Foundations*, Geotechnical Engineering, Fourth Edition, Macmillan, New York.
- Stagg, K. G., and Zienkiewicz, O.C. (1968). *Rock Mechanics in Engineering Practice*, John Wiley & Sons, Inc., New York.
- Stokoe, K. H., and Woods, R. D. (1972). "In-situ shear wave velocity by cross-hole method." *Journal of the Soil Mechanics & Foundations Division.*, ASCE, 98 (5), 443-460.
- Stokoe, K. H., and Hoar, R. J. (1978). "Variables affecting in-situ seismic measurement." *Proceedings., Earthquake Engineering and Soil Dynamics*, ASCE, Pasadena, Ca, 919-938.
- Tanaka, H. and Tanaka, M. (1998). "Characterization of sandy soils using CPT and DMT", *Soils and Foundations*, Vol. 38 (3), 55-67
- Tatsuoka, F. and Shibuya, S. (1992). "Deformation characteristics of soils & rocks from field & lab tests." *Report of the Institute of Industrial Science* 37 (1), Serial No. 235, University of Tokyo, 136 p.
- Tatsuoka, F., Jardine, R.J., LoPresti, D.C.F., DiBenedetto, H., and Kodaka, T. (1997). "Theme Lecture: Characterizing the pre-failure deformation properties of geomaterials". *Proceedings, 14th International Conf. on Soil Mechanics & Foundation Engineering*, Vol. 4, Hamburg, 2129-2164.
- Tavenas, F., LeBlond, P., Jean, P., and Leroueil, S. (1983). "The permeability of natural soft clays: Parts I and II", *Canadian Geotechnical Journal*, Vol. 20 (4), 629-660.
- Taylor, D. W. (1948). *Fundamentals of Soil Mechanics*, John Wiley & Sons, Inc., New York.
- Teh, C.I. and Houlsby, G.T. (1991). "An analytical study of the cone penetration test in clay". *Geotechnique*, Vol. 41 (1), 17-34.
- Terzaghi, K., and Peck, R. B. (1967). *Soil Mechanics in Engineering Practice*, John Wiley & Sons, Inc., New York, 729 p.
- Terzaghi, K., Peck, R.B., and Mesri, G. (1996). *Soil Mechanics in Engineering Practice, Second Edition*, Wiley and Sons, Inc., New York, 549 p.
- U.S. Environmental Protection Agency (EPA). (1991). *Description and sampling of contaminated soils*, (EPA/625/12-9/002; November), Washington, D.C.
- U.S. Department of the Interior, Bureau of Reclamation. (1973). *Design of small dams*, United States Government Printing Office, Washington, D.C.
- U.S. Army Corps of Engineers. (1951). "Time lag and soil permeability in groundwater observations." *Waterways Experiment Station, Bulletin No. 36*, Vicksburg, MS.

- U.S. Department of the Interior, Bureau of Reclamation (1960). *Earth manual*, United States Government Printing Office, Washington, D.C.
- U.S. Department of the Interior, Bureau of Reclamation. (1986). "Soil classification handbook on Unified soil classification system." *Training Manual No. 6*; January, Geotechnical Branch, Washington, D.C.
- Van Schalkwyk, A., Dooge, N., and Pitsiou, S. (1995). "Rock mass characterization for evaluation of erodibility". *Proceedings, 11<sup>th</sup> European Conference on Soil Mechanics and Foundation Engineering*, Vol. 3, Copenhagen, Danish Geotechnical Society Bulletin 11, 281-287.
- Vucetic, M. and Dobry, R. (1991). "Effect of soil plasticity on cyclic response". *Journal of Geotechnical Engineering*, Vol. 117 (1), 89-107.
- Way, D.S. (1973). *Terrain Analysis*, Dowden, Hutchinson & Ross, Inc., Stroudsburg, Pa.
- Williamson, D.A. (1984). "Unified rock classification system." *Bulletin of the Association of Engineering Geologists*, Vol. XXI (3), 345-354.
- Windle, D., and Wroth, C. P. (1977). "In-situ measurement of the properties of stiff clays." *Proceedings, 9th International Conference on Soil Mechanics and Foundation Engineering*, Vol. 1, Tokyo, Japan, 347-352.
- Witczak, M.W. (1972). "Relationships between physiographic units and highway design factors." *National Cooperative Highway Research Program: Report 132*, Washington D.C.
- Wittke, W. (1990). *Rock Mechanics: Theory and Applications with Case Histories*, Springer-Verlag, New York.
- Woods, R. D. (1978). "Measurement of soil properties - state of the art report." *Proceedings, Earthquake Engineering and Soil Dynamics*, Vol. I, ASCE, Pasadena, CA, 91-178.
- Woods, R.D. (1994). "Laboratory measurement of dynamic soil properties". *Dynamic Geotechnical Testing II* (STP 1213), ASTM, West Conshohocken, PA, 165-190.
- Wroth, C. P., and Wood, D. M. (1978). "The correlation of index properties with some basic engineering properties of soils." *Canadian Geotechnical Journal*, Vol. 15 (2), 137-145.
- Wroth, C. P. (1984). "The interpretation of in-situ soil tests." 24<sup>th</sup> Rankine Lecture, *Géotechnique*, Vol. 34 (4), 449-489.
- Wyllie, D. C. (1992). *Foundations on Rock*. First Edition, E&F Spon Publishers, Chapman and Hall, London, 333 p.
- Youd, T.L. (1973). "Factors controlling maximum and minimum densities of sands". *Evaluation of Relative Density*, STP 523, ASTM, West Conshohocken/PA, 98-112.



## Appendix A

# SAFETY GUIDELINES FOR DRILLING INTO SOIL AND ROCK AND HEALTH AND SAFETY PROCEDURES FOR ENTRY INTO BORINGS

## A.1 SAFETY GUIDELINES FOR DRILLING INTO SOIL AND ROCK

### A.1.1 Purpose

The purpose of this operating procedure is to provide guidelines for safe conduct of drilling operations with truck-mounted and other engine-powered drill rigs. The procedure addresses off-road movement of drill rigs, overhead and buried utilities, use of augers, rotary and core drilling, and other drilling operations and activities.

### A.1.2 Application

The guidelines apply to projects in which truck-mounted or other engine-powered drill rigs are used. Normally for drill rigs operated by contractors, drill rig safety is the responsibility of the contractor.

### A.1.3 Responsibility and Authority

Drill rig safety and maintenance is the responsibility of the drill rig operator.

### A.1.4 Safety Guidelines

#### Movement of Drill Rigs

Before moving a rig, the operator must do the following:

1. As practical, inspect the planned route of travel for depressions, gullies, ruts, and other obstacles.
2. Check the brakes of the truck/carrier, especially if the terrain along the route of travel is rough or sloped.
3. Discharge all passengers before moving on rough or steep terrain.
4. Engage the front axle (on 4 x 4, 6 x 6, etc., vehicles) before traversing rough or steep terrain.

Driving drill rigs along the sides of hills or embankments should be avoided; however, if sidehill travel becomes necessary, the operator must conservatively evaluate the ability of the rig to remain upright while on the hill or embankment and take appropriate steps to ensure its stability.

Logs, ditches, road curbs, and other long and horizontal obstacles should be normally approached and driven over squarely, not at an angle.

When close lateral or overhead clearance is encountered, the driver of the rig should be guided by another person on the ground.

Loads on the drill rig and truck must be properly stored while the truck is moving, and the mast must be in the fully lowered position.

After the rig has been positioned to begin drilling, all brakes and/or locks must be set before drilling begins. If the rig is positioned on a steep grade and leveling of the ground is impossible or impractical, the wheel of the transport vehicle should be blocked and other means of preventing the rig from moving or tipping over should be employed.

#### **A.1.5 Buried and Overhead Utilities**

The location of overhead and buried utility lines must be determined before drilling begins, and their locations should be noted on boring plans or assignment sheets.

When overhead power lines are close, the drill rig mast should not be raised unless the distance between the rig and the nearest power line is at least 6 m, or other distance as required by local ordinances, whichever is greater. The drill rig operator or assistant should walk completely around the rig to make sure that proper distance exists.

When the drill rig is positioned near an overhead line, the rig operator should be aware that hoist lines and power lines can be moved towards each other by wind. Presence of power lines requires special safety provisions as they present serious danger

#### **A.1.6 Clearing the Work Area**

Before a drill rig is positioned to drill, the area should be cleared of removable obstacles and the rig should be leveled if sloped. The cleared/leveled area should be large enough to accommodate the rig and supplies.

#### **A.1.7 Safe Use of Hand Tools**

OSHA regulations regarding hand tools should be observed in addition to the guidelines provided below:

1. Each tool should be used only to perform tasks for which it was originally designed.
2. Damaged tools should be repaired before use or they should be discarded.
3. Safety goggles or glasses should be worn when using a hammer or chisel. Nearby coworkers and bystanders should be required to wear safety goggles or glasses also, or to move away.
4. Tools should be kept cleaned and stored in an orderly manner when not in use.

#### **A.1.8 Safe Use of Wire Line Hoists, Wire Rope, and Hoisting Hardware**

Safety rules described in 29 CFR 1926.552 and guidelines contained in the Wire RPE User's Manual, published by the American Iron and Steel Institute, will be used whenever wire line hoists, wire rope, or hoisting hardware are used.

### **A.1.9 Protective Gear**

#### **Minimum Protective Gear**

Items listed below should be worn by all members of the drilling team while engaged in drilling activities:

- Hard hat
- Safety shoes (shoes or boots with steel toes and shanks)
- Gloves

#### **Other Gear**

Items listed below should be worn when conditions warrant their use. Some of the conditions are listed after each item.

- **Safety goggles or glasses** should be worn when: (1) driving pins in and out of drive chains, (2) replacing keys in tongs, (3) handling hazardous chemicals, (4) renewing or tightening gauge glasses, (5) breaking concrete, brick, or cast iron, (6) cleaning material with chemical solutions, (7) hammering or sledging on chisels, cold cuts, or bars, (8) cutting wire lines, (9) grinding on abrasive wheels, (10) handling materials in powered or semipowered form, (11) scraping metal surfaces, (12) sledging rock bits or core heads to tighten or loosen them, (13) hammering fittings and connections, and (14) driving and holding the rivets.
- **Safety belts and lifelines** should be worn by all persons working on top of an elevated derrick beam. The lifeline should be secured at a position that will allow a person to fall no more than 8 feet.
- **Life vests** must be used for work over water.

### **A.1.10 Traffic Safety**

Drilling in streets, parking lots, or other areas of vehicular traffic requires definition of the work zones with cones, warning tape, etc., and compliance with local police requirements.

### **A.1.11 Fire Safety**

1. Fire extinguishers should be kept on or near drill rigs for extinguishing small fires.
2. If methane is suspected in the area, a combustible gas instrument (CGI) shall be used to monitor the air near the borehole. All work should stop at 25 percent of the lower explosive limit.
3. Work shall stop during lightning storms.

## **A.2 HEALTH AND SAFETY PROCEDURES FOR ENTRY INTO BORINGS**

### **A.2.1 Purpose**

Down-hole geologic logging entails lowering a person into an uncased boring generally to gather information on the stratigraphy of the soil. Descent in some cases may exceed 30 m. The boring is a confined space, hence, hazards typical of confined spaces may be present. The major ones are oxygen deficiency, flammable concentrations of gases or vapors, toxic concentrations of gas or vapors, and wall collapse. Because visual inspection of the walls of the boring is essential to the logging process, the borings cannot be cased. These guidelines are prepared for down-hole logging operations, sound and uniform health and safety procedures that are in compliance with federal and state regulations.

These guidelines of the procedure are in full compliance with OSHA regulations contained in 29 CFR 1926.552, 29 CFR 1926.800 and incorporate more stringent regulations promulgated by Cal-OSHA and described in Section 1542, Subchapter 4, and Article 108, Subchapter 7, Division 4, Title 8 of the California Administrative Code (CAC). In all cases the local and state regulations regarding confined space entry and shaft entry must be reviewed and provisions more stringent than those contained in this operating procedure should be observed.

### **A.2.2 Applicability**

This procedure applies to down-hole logging operations associated with geotechnical projects where toxic chemical releases are not known to have occurred. **The procedure may be used for downhole logging operations where toxic chemical releases have occurred, but only as an attachment to a site-specific health and safety plan that assesses the exposure risks associated with the logging operation and prescribes appropriate chemical-specific procedures for worker protection against the excessive exposure.**

### **A.2.3 Responsibility and Authority**

The field supervisor and/or the geotechnical engineer have overall responsibility for safe conduct of the downhole logging operation and may not delegate that responsibility to another person.

### **A.2.4 Health and Safety Requirements**

#### **Permit Acquisition**

Some states, such as California, require permits for construction of shafts to be entered by personnel and exceeding a certain depth (1.5 m in California). State and local government permit requirements shall be reviewed and complied with before any shaft is constructed.

#### **Pre-entry Inspection**

A qualified geotechnical specialist (engineer/geologist) shall be present a sufficient amount of time during the drilling process to thoroughly inspect and record the material and stability characteristics of the shaft and decide whether the walls of the shaft are stable enough so that it may be entered safely. Entry shall not be permitted if, in the specialist's opinion, the walls could collapse.

A qualified geotechnical specialist is an individual who has the following minimum qualifications:

1. Extensive hands-on experience in drilling and downhole geologic logging of uncased large-diameter borings so that the person is considered an expert by peers.
2. Experience in performing down-hole inspection or logging in the local area where work is being performed and/or experience in performing down-hole inspection/logging in other areas with similar geologic characteristics.
3. Prior training by other experienced geotechnical professionals.
4. Familiarity with the safe operation of the drilling and logging equipment being used, and the special difficulties, hazards, and mitigation techniques used in down-hole geologic logging.

### **Surface Casing and Proximity of Material to the Shaft Opening**

The upper portion of the shaft shall be equipped with a surface ring-collar to provide casing support of the material within the upper 1.2 m or more of the shaft. The ring collar shall extend to 300 mm above the ground surface or as high as necessary to prevent drill cuttings and other loose material or objects from falling into or blocking access to the shaft. Drill cuttings, detached auger buckets, and other loose equipment must be placed far enough away from the shaft opening or secured in a fashion that would prevent them from falling into the shaft.

### **Gas Test**

Prior to entry into a shaft, tests shall be performed to determine if the atmosphere in the shaft is not oxygen deficient and does not contain explosive or toxic levels of gases or vapors. Testing shall continue throughout the logging process to assure that dangerous atmospheric conditions do not develop. Monitoring instruments shall include a combustible gas meter and an oxygen meter. Where toxic gases or vapors may be present, a monitoring instrument equipped with a photoionization detector should be used for detection and quantification.

### **Ladders and Cable Descents**

A ladder may be used to descend a shaft provided that the shaft is no deeper than 6 m. A mechanical hoisting device shall be used with shafts more than 6 m deep.

### **Hoists**

Hoists may be powered or hand operated and must be worm geared or powered both ways. They must be designed so that when power is stopped, the load cannot move. Controls for powered hoists must be the deadman type with non-locking switch or control. A device for shutting off the power shall be installed ahead of the operating control. Hoist machines shall not have cast metal parts. Each hoist must be tested with twice the maximum load before being put into operation and annually thereafter. California regulations require a minimum safety factor of 6 for hoists. Test results shall be kept on file at the geotechnical engineer's office and other offices as required by the agency engaged in the geologic logging procedure. The hoist cable must have a diameter of at least 8 mm. Drill rigs may not be used to raise or lower personnel in shafts unless they meet the requirements in this section.

## **Cage**

An enclosed covered metal cage shall be used to raise and lower persons in the shaft. The cage shall have a minimum safety factor of 4 and shall be load tested prior to use. The exterior of the cage shall be free of projections and sharp corners. Only closed shackles shall be used in cage rigging. The cage shall be certified by a registered mechanical engineer as having met all the design specifications. The certificate and load test results shall be kept on file.

## **Emergency Standby**

In addition to the hoist or drill rig operator, an emergency standby person shall be positioned at the surface near the shaft whenever there is a geotechnical specialist in the shaft.

## **Communication**

A two-way electrically-operated communication system shall be in operation between the standby person and the geotechnical specialist whenever the standby person and the geotechnical specialist is in a shaft that is over 6 m in depth or when the ambient noise level makes unamplified voice communication difficult. A cellular telephone at the drill rig is strongly recommended.

## **Safety Equipment**

The geotechnical specialist must use the following safety equipment while in the shaft:

1. An approved safety harness designed to suspend a person upright. The harness must be attached to the hoist cable through a hole in the head guard. Attaching the harness to the head guard or cage is strictly prohibited.
2. Hardhat.
3. A steel cone-shaped or flat head guard or deflector with a minimum diameter of 450 mm must be attached to the hoist cable above the harness.

## **Electrical Devices**

Electrical devices, such as lamps, combustible gas and toxic vapor detectors, and electric tools, must be approved for use in hazardous locations.

## **Surface Hazards**

The storage and use of flammable or other dangerous chemicals at the surface must be controlled to prevent them from entering the shaft.

## **Water Hazard**

The presence of water in the shaft must be determined before the shaft is entered. If the shaft contains more than 1.2 m of water, the level of water must be reduced to less than 1.2 m before entry is permitted. If a shaft is entered when water is present, the depth of the water must be measured periodically and the water level kept below 1.2 m if work is to continue.

**Air Supply**

NIOSH-approved supplied-air respirators (SCBA or airline) shall be available in the cage for use in the shaft when oxygen deficient atmosphere or toxic gases or vapors are encountered. If an airline system is used, the air pump or compressed air supply must be attended to by a person at the surface.

**Illumination**

Light intensity in the portion of the shaft being logged must be at least 3 m center-to-center. Lighting devices must be explosion-proof.

**Work/Rest Periods**

Time spent continuously in a shaft must not exceed two hours.

[Blank]



## Appendix B

### GEOTECHNICAL EQUIPMENT SUPPLIERS and SERVICE TESTING COMPANIES

#### **Soil Sampling, Drilling Rigs, Augering, & Rock Coring:**

<http://www.boartlongyear.com/subsnew/pages/prodserv.htm>

<http://www.christensenproducts.com/html/products.htm>

<http://www.cmeco.com/index.html>

<http://www.mobile-augers.com/>

<http://www.greggdrilling.com/>

<http://www.paddockdrilling.com/html/ct250.html>

#### **Continuous Soil Sampling Methods**

<http://www.ams-samplers.com/amsc1.html>

<http://www.geoprobesystems.com/66dtdesc.htm>

#### **Flat Plate Dilatometer Test (DMT) for soils:**

*General:* <http://webdisat.ing.univaq.it/labs/dmt/geodmt.html>

*Suppliers:*

[http://www.cambridge-insitu.com/DMT/Marchetti\\_Index.html](http://www.cambridge-insitu.com/DMT/Marchetti_Index.html)

<http://www.geotech.se/Dilatometer/dilatometer.html>

<http://www.gpe.org>

<http://www.pagani-geotechnical.com/english/dmt.htm>

## **Cone Penetration Testing (CPT):**

*General:*

*The CPT Site at:* <http://www.liquefaction.com>

*Suppliers:*

<http://www.ara.com/division/arane/cpt/CPTList.htm>

<http://www.envi.se/>

<http://www.geomil.com/>

<http://www.geotech.se/>

<http://www.hogentogler.com>

<http://www.pagani-geotechnical.com/english/geotec2.htm>

*Service Companies:*

<http://www.conetec.com/>

<http://www.fugro.com/cpt.html>

<http://www.greggdrilling.com/INSitu.html>

<http://www.stratigraphics.com/>

## **Pressuremeter Testing (PMT):**

<http://www.cambridge-insitu.com/>

<http://www.pagani-geotechnical.com/english/pressure.htm>

<http://www.roctest.com/roctelemac/product/product/boremac.html>

*Dilatometers for Testing Rocks:*

<http://www.cambridge-insitu.com/specs/Instruments/73HPDSPC.htm>

**Vane Shear Test (VST) or field vane (FV):**

*General:* <http://www.liquefaction.com/insitutests/vane/index.htm>

<http://www.apvdBerg.nl/products/16.htm>

<http://www.envi.se/products.htm>

<http://www.geonor.com/Soiltst.html>

<http://www.pagani-geotechnical.com/>

**Geophysical testing:**

*General Information:*

<http://www.geoforum.com/knowledge/texts/bodare/index.asp?Lang=Eng>

[http://www.matrixmm.com/geophysics\\_cd-rom.htm](http://www.matrixmm.com/geophysics_cd-rom.htm)

[http://talus.mines.edu/fs\\_home/tboyd/GP311/introgp.shtml](http://talus.mines.edu/fs_home/tboyd/GP311/introgp.shtml)

*Suppliers of Equipment:*

<http://www.geometrics.com/products.html>

<http://www.geonics.com/products.html>

<http://www.geospacecorp.com/geophys.htm>

<http://www.oyo.com/Seismic/Products/das.htm>

<http://www.pagani-geotechnical.com/english/geophi.htm>

<http://www.sensoft.on.ca>

*Testing Companies:*

<http://www.agi.com>

<http://www.geovision.com>

<http://www.greggdrilling.com/methodology.html#sasw>

<http://olsoninstruments.com>

**Field Instrumentation Equipment**

<http://www.geocon.com>

<http://www.geokon.com/>

<http://www.rst-inst.com/>

<http://www.slopeindicator.com/>

<http://www.solinst.com/indexnet.html>

**Laboratory Testing Equipment Suppliers:**

<http://www.gcts.com/>

<http://www.geocon.com>

<http://www.geocomp.com/>

<http://www.gsc.state.tx.us/ecat/vendor/2198428045900.html>

[http://www.hmc-hsi.com/newest/hmc\\_catalog/Soil/soil.html](http://www.hmc-hsi.com/newest/hmc_catalog/Soil/soil.html)

<http://www.soiltest.com/>

<http://www.terratek.com/testequi.htm>

**Related books on In-Situ Testing available at:**

<http://www.guideme.com/Bookstores/INSITU.HTM>

**Related CDs & videos on In-Situ Methods:**

<http://www.geoinstitute.org/in-situ.html>

**Website Links to In-Situ Testing:**

<http://www.usucger.org>