

سایت آموزشی و تفریحی

تک مگابایت

TakMb.ir



FIFA®



/ FUTSAL

Laws of the Game
2014/2015

Fédération Internationale de Football Association

President:	Joseph S. Blatter
Secretary General:	Jérôme Valcke
Address:	FIFA FIFA-Strasse 20 P.O. Box 8044 Zurich Switzerland
Telephone:	+41 (0)43 222 7777
Fax:	+41 (0)43 222 7878
Internet:	FIFA.com

Fédération Internationale de Football Association

President: Joseph S. Blatter (Switzerland)
 Secretary General: Jérôme Valcke (France)
 Address: FIFA-Strasse 20
 P.O. Box
 8044 Zurich
 Switzerland
 Telephone: +41 (0)43 222 7777
 Telefax: +41 (0)43 222 7878
 Internet: www.FIFA.com

Futsal Committee

Chairman:	Worawi Makudi	Thailand
Deputy chairman:	Eugenio Figueredo	Uruguay
Members:	Jilong Zhang	China PR
	Petr Fousek	Czech Republic
	Álvaro Melo Filho	Brazil
	Rafael Tinoco	Guatemala
	Hans Boll	Netherlands
	Ali Kafashian	Iran
	Vitor Lup Kwan Cheung	Macau
	Antonio Escribano	Spain
	Rignaal Francisca	Curaçao
	Ruben Hayrapetyan	Armenia
	Magdi Shams Eldin	Sudan
	Quoc Tuan Tran	Vietnam
	Ilcho Gjorgjioski	FYR Macedonia
	Yildirim Demiroren	Turkey
	Raymond Guishard	Anguilla
	Raymond Tim Kee	Trinidad and Tobago
	Rolando López Sanders	Nicaragua
	Domingo Mituy	Equatorial Guinea
	Anwar Altashani	Libya
	Jules Hmeun	New Caledonia
	Juneidi Tilmo	Ethiopia

Notes on the Futsal Laws of the Game

Modifications

Subject to the agreement of the member association concerned and provided that the principles of these Laws are maintained, the Laws may be modified in their application for matches for players of under 16 years of age, for women footballers, for veteran footballers (over 35 years of age) and for players with disabilities.

Any or all of the following modifications are permissible:

- size of the pitch
- size, weight and material of the ball
- width between the goalposts and height of the crossbar from the ground
- duration of the periods of play
- substitutions

Further modifications are only allowed with the consent of the FIFA Refereeing Department and the approval of the FIFA Futsal Committee.

N.B. Terms referring to natural persons are applicable to both genders.

Key

The following symbol is used in the Futsal Laws of the Game:
a single line in the margin indicates new Law changes.

<i>Article</i>	<i>Page</i>
1 – The Pitch	6
2 – The Ball	13
3 – The Number of Players	15
4 – The Players' Equipment	19
5 – The Referees	21
6 – The Assistant Referees	25
7 – The Duration of the Match	29
8 – The Start and Restart of Play	33
9 – The Ball In and Out of Play	36
10 – The Method of Scoring	37
11 – Offside	38
12 – Fouls and Misconduct	39
13 – Free Kicks	43
14 – The Penalty Kick	51
15 – The Kick-in	54
16 – The Goal Clearance	57
17 – The Corner Kick	59
Procedures to Determine the Winner of a Match or Home-and-Away Tie	61
The Technical Area	64
The Reserve Assistant Referee	66
Referee and Assistant Referee Signals	67
Interpretation of the Futsal Laws of the Game and Guidelines for Referees	77

Pitch surface

Matches should be played on flat, smooth and non-abrasive surfaces, preferably made of wood or artificial material, according to the rules of the competition. Concrete or tarmac should be avoided.

Artificial turf pitches are permitted in exceptional cases and only for domestic competitions.

Pitch markings

The pitch must be rectangular and marked with lines. These lines belong to the areas of which they are boundaries and must be clearly distinguishable from the colour of the pitch.

The two longer boundary lines are called touch lines. The two shorter lines are called goal lines.

The pitch is divided into two halves by a halfway line, which joins the midpoints of the two touch lines.

The centre mark is indicated at the midpoint of the halfway line. A circle with a radius of 3m is marked around it.

A mark must be drawn outside the pitch, 5m from the corner arc and at right angles to the goal line, to ensure that defending players retreat this distance when a corner kick is being taken. The width of this mark is 8cm.

Two additional marks, each at a distance of 5m to the left and the right of the second penalty mark, must be made on the pitch to indicate the minimum distance to be retreated when a kick is being taken from the second penalty mark. The width of this mark is 8cm.

Dimensions

The length of the touch line must be greater than the length of the goal line.

All lines must be 8cm wide.

For non-international matches, the dimensions are as follows:

Length (touch line):	minimum	25m
	maximum	42m
Width (goal line):	minimum	16m
	maximum	25m

For international matches, the dimensions are as follows:

Length (touch line):	minimum	38m
	maximum	42m
Width (goal line):	minimum	20m
	maximum	25m

The penalty area

Two imaginary lines of 6m in length are drawn from the outside of each goalpost and at right angles to the goal line; at the end of these lines a quarter circle is drawn in the direction of the nearest touch line, each with a radius of 6m from the outside of the goalpost. The upper part of each quarter circle is joined by a line 3.16m in length running parallel to the goal line between the goalposts. The area bounded by these lines and the goal line is the penalty area.

Within each penalty area, a penalty mark is made 6m from the midpoint between the goalposts and equidistant to them.

The second penalty mark

A second mark is made 10m from the midpoint between the goalposts and equidistant to them.

The corner arc

A quarter circle with a radius of 25cm from each corner is drawn inside the pitch.

Goals

A goal must be placed on the centre of each goal line.

A goal consists of two upright posts equidistant from the corners and joined at the top by a horizontal crossbar. The goalposts and crossbar must be made of wood, metal or other approved material. They must be square, rectangular, round or elliptical in shape and must not be dangerous to players.

The distance (inside measurement) between the posts is 3m and the distance from the lower edge of the crossbar to the ground is 2m.

Both goalposts and the crossbar have the same width and depth, 8cm. The nets must be made of hemp, jute or nylon or other approved material and are attached to the back of the goalposts and the crossbar with a suitable means of support. They must be properly supported and must not interfere with the goalkeeper.

The goalposts and crossbars must be of a different colour from the pitch.

The goals must have a stabilising system that prevents them from overturning. Portable goals may only be used if they satisfy this requirement.

The substitution zones

The substitution zones are the areas on the touch line in front of the team benches, the purpose of which is described in Law 3.

- They are situated in front of the technical area and are 5m in length. They are marked at each end with a line 80cm in length, 40cm of which is drawn on the pitch and 40cm off the pitch, and 8cm wide
- The area in front of the timekeeper's table 5m to either side of the halfway line is kept clear
- A team's substitution zone is situated in the half of the pitch defended by said team and changes in the second half of the match and periods of extra time, if any

Pitch

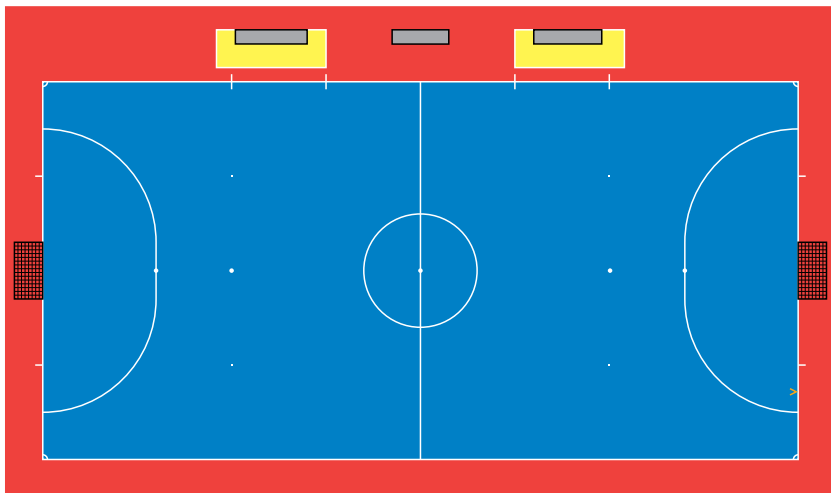

Pitch dimensions

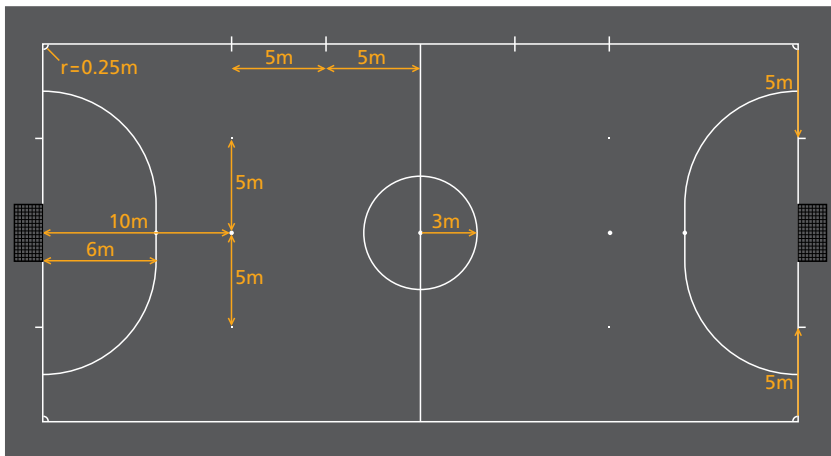

Penalty area

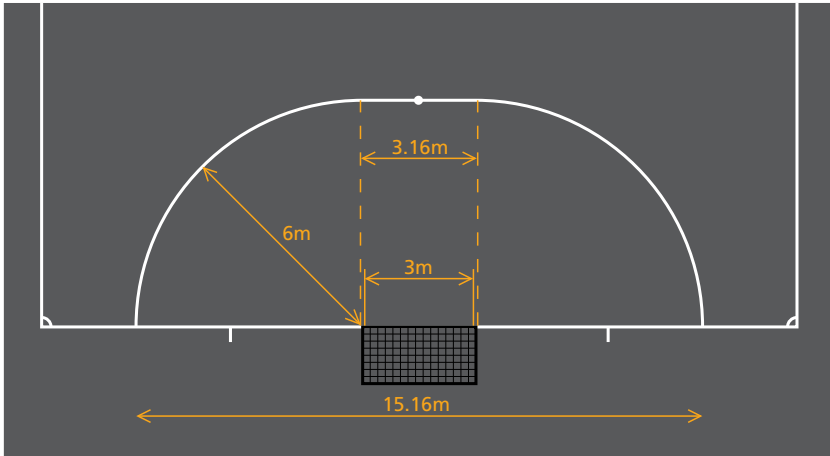

Goal

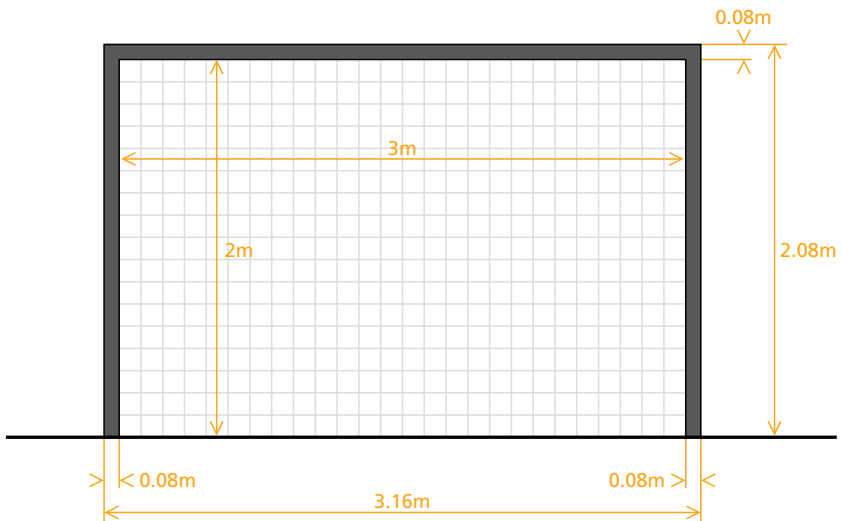

Substitution zone and technical area

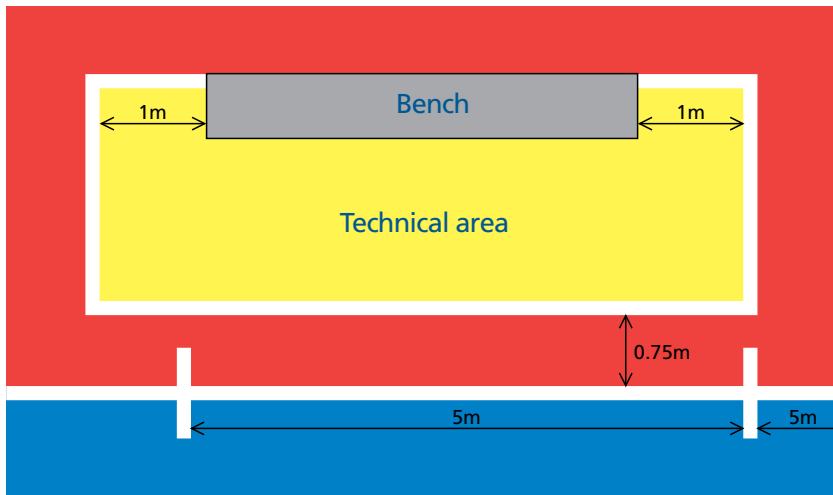

Decision 1

The technical area must meet the requirements contained in the section entitled "The Technical Area".

Qualities and measurements

The ball is:

- spherical
- made of leather or other approved material
- of a circumference of not more than 64cm and not less than 62cm
- not more than 440g and not less than 400g in weight at the start of the match
- of a pressure equal to 0.6 – 0.9 atmosphere (600 – 900g/cm²) at sea level
- the ball may not bounce less than 50cm or more than 65cm on the first rebound when dropped from a height of 2m

Replacement of a defective ball

If the ball bursts or becomes defective during the course of a match, the match is stopped.

- The match is restarted by dropping the replacement ball at the place where the original ball became defective, unless play was stopped inside the penalty area, in which case one of the referees drops the replacement ball on the penalty area line at the point nearest to where the original ball was located when play was stopped
- The match is restarted by retaking the kick if the ball bursts or becomes defective while a direct free kick without a wall, a kick from the second penalty mark or a kick from the penalty mark is being taken and does not touch the goalposts, the crossbar or a player and no infringement is committed

If the ball bursts or becomes defective while not in play (at a kick-off, goal clearance, corner kick, dropped ball, free kick, penalty kick or ball inbound):

- the match is restarted in accordance with the Futsal Laws of the Game

The ball may not be changed during the match without the authority of the referees.

Logos on balls

In addition to the requirements of Law 2, acceptance of a ball for use in matches played in an official competition organised under the auspices of FIFA or the confederations is conditional upon the ball bearing one of the following:

- the official “FIFA APPROVED” logo
- the official “FIFA INSPECTED” logo
- the “INTERNATIONAL MATCHBALL STANDARD” logo



IMS
INTERNATIONAL
MATCHBALL
STANDARD

Such a logo on a ball indicates that it has been tested officially and found to be in compliance with specific technical requirements, different for each logo and additional to the minimum specifications stipulated in Law 2. The list of the additional requirements specific to each of the respective logos must be approved by the International F.A. Board. The institutes conducting the tests are subject to the approval of FIFA.

Member association competitions may also require the use of balls bearing any one of these three logos.

Advertising

In matches played in an official competition organised under the auspices of FIFA, the confederations or the member associations, no form of commercial advertising on the ball is permitted, except for the emblem of the competition, the name of the competition organiser and the authorised trademark of the manufacturer. The name of the competition regulations may restrict the size and number of such markings.

Players

A match is played by two teams, each consisting of not more than five players, one of whom is the goalkeeper.

A match may not start if either team consists of fewer than three players.

The match is abandoned if one of the teams has fewer than three players on the pitch.

Official competitions

Up to a maximum of nine substitutes may be used in any match played in an official competition organised under the auspices of FIFA, the confederations or the member associations. The rules of the competition must state how many substitutes may be nominated, up to a maximum of nine.

The number of substitutions that may be made during a match is unlimited.

Other matches

In national "A" team matches, up to a maximum of ten substitutes may be used.

In all other matches, a greater number of substitutes may be used, provided that:

- the teams concerned reach agreement on a maximum number
- the referees are informed before the match

If the referees are not informed, or if no agreement is reached before the match, no more than ten substitutes are allowed.

All matches

In all matches, the names of the players and substitutes must be given to the referees prior to the start of the match, whether they are present or not. Any substitute whose name is not given to the referees at this time may not take part in the match.

Substitution procedure

A substitution may be made at any time, whether the ball is in play or not. To replace a player with a substitute, the following conditions must be observed:

- The player leaves the pitch via his own team's substitution zone, save in the exceptions provided for in the Futsal Laws of the Game
- The substitute only enters the pitch after the player being replaced has left
- The substitute enters the pitch via his own team's substitution zone
- The substitution is completed when a substitute enters the pitch via his own team's substitution zone, after handing his bib to the player being replaced, unless this player has had to leave the pitch via another zone for any reason provided for in the Laws of the Game, in which case the substitute shall hand his bib to the third referee
- From that moment, the substitute becomes a player and the player he has replaced becomes a substituted player
- The substituted player may take further part in the match
- All substitutes are subject to the authority and jurisdiction of the referees, whether called upon to play or not
- If a period is extended to allow a penalty kick, a kick from the second penalty mark or a direct free kick without a wall to be taken, only the goalkeeper of the defending team may be substituted

Changing the goalkeeper

- Any of the substitutes may change places with the goalkeeper without informing the referees or waiting for a stoppage in the match
- Any player may change places with the goalkeeper
- The player changing places with the goalkeeper must do so during a stoppage in the match and must inform the referees before the change is made
- A player or substitute replacing the goalkeeper must wear a goalkeeper's jersey with his number on the back

Infringements and sanctions

If a substitute enters the pitch before the player being replaced has left or, during a substitution, a substitute enters the pitch from a place other than his own team's substitution zone:

- the referees stop play (although not immediately if they can apply the advantage)
- the referees caution him for infringing the substitution procedure and order him to leave the pitch

If the referees have stopped play, it is restarted with an indirect free kick to the opposing team from the position of the ball at the time of the stoppage (see Law 13 – Position of free kick). If this substitute or his team also commits another infringement, play is restarted in accordance with the section entitled "Interpretation of the Futsal Laws of the Game and Guidelines for Referees" (Law 3).

If, during a substitution, the player being replaced leaves the pitch for reasons not provided for in the Futsal Laws of the Game and via a place other than his own team's substitution zone:

- the referees stop play (although not immediately if they can apply the advantage)
- the referees caution the player for infringing the substitution procedure

If the referees have stopped play, it is restarted with an indirect free kick to the opposing team from the position of the ball at the time of the stoppage (see Law 13 – Position of free kick).

In the event of any other infringements of this Law:

- the players concerned are cautioned
- the match is restarted with an indirect free kick to the opposing team from the position of the ball at the time of the stoppage (see Law 13 – Position of free kick). In special cases, play is restarted in accordance with the section entitled "Interpretation of the Futsal Laws of the Game and Guidelines for Referees" (Law 3)

Players and substitutes sent off

A player who has been sent off before the kick-off may be replaced only by one of the named substitutes.

A named substitute who has been sent off, either before the kick-off or after play has started, may not be replaced.

A substitute may replace a sent-off player and enter the pitch after two minutes of playing time have elapsed since the sending-off, provided that he has the authorisation of the timekeeper or the third referee (assistant referees), unless a goal is scored before the two minutes have elapsed, in which case the following conditions apply:

- If there are five players against four and the team with the greater number of players scores a goal, the team with only four players may be completed with a fifth player
- If both teams are playing with three or four players and a goal is scored, both teams remain with the same number of players
- If there are five players playing against three, or four against three, and the team with the greater number of players scores a goal, the team with three players may be increased by one player only
- If the team that scores the goal is the one with fewer players, the game continues without changing the number of players

Safety

A player must not use equipment or wear anything that is dangerous to himself or another player (including any kind of jewellery).

Basic equipment

The basic compulsory equipment of a player comprises the following separate items:

- A jersey or shirt – if undergarments are worn, the colour of the sleeve must be the same main colour as the sleeve of the jersey or shirt
- Shorts – if undershorts are worn, they must be of the same main colour as the shorts. The goalkeeper is permitted to wear long trousers
- Stockings – if tape or similar material is applied externally it must be the same colour as that part of the stocking it is applied to
- Shinguards
- Footwear – canvas or soft leather training or gymnastic shoes with soles of rubber or a similar material

Shinguards

- are covered entirely by the stockings
- are made of rubber, plastic or a similar approved material
- provide a reasonable degree of protection

Colours

- The two teams must wear colours that distinguish them from each other and also the referees and the assistant referees
- Each goalkeeper must wear colours that distinguish him from the other players, the referees and the assistant referees

Infringements and sanctions

In the event of any infringement of this Law:

- play need not be stopped
- the player at fault is instructed by the referees to leave the pitch to correct his equipment when the ball next ceases to be in play, unless he has already corrected his equipment

- any player required to leave the pitch to correct his equipment must not re-enter without the permission of the referees or third referee
- the referees, either directly or through the third referee, check that the player's equipment is correct before allowing him to re-enter the pitch
- the player, if he has not been substituted, is only allowed to re-enter the pitch when the ball is out of play or under the supervision of the third referee when the ball is in play

A player having been required to leave the pitch because of an infringement of this Law and not having been substituted who re-enters the pitch without the permission of the referees or third referee must be cautioned.

Restart of play

If play is stopped by the referees to administer a caution:

- the match is restarted with an indirect free kick taken by a player of the opposing team, from the place where the ball was located when the referees stopped the match (see Law 13 – Position of free kick)

Advertising on equipment

Basic compulsory equipment

The basic compulsory equipment must not have any political, religious or personal slogans, images or statements. The team of a player whose basic compulsory equipment has political, religious or personal slogans, images or statements will be sanctioned by the competition organiser or by FIFA.

Undergarments

Players must not reveal undergarments showing political, religious or personal slogans, images or statements, or any advertising other than the manufacturer's logo.

Players or teams revealing undergarments showing political, religious or personal slogans, images or statements or advertising other than the manufacturer's logo will be sanctioned by the competition organiser or by FIFA.

The authority of the referees

Each match is controlled by two referees, the referee and the second referee, who have full authority to enforce the Futsal Laws of the Game in connection with the match to which they have been appointed.

Powers and duties

The referees:

- enforce the Futsal Laws of the Game
- control the match in cooperation with the assistant referees, where applicable
- ensure that any ball used meets the requirements of Law 2
- ensure that the players' equipment meets the requirements of Law 4
- keep a record of match incidents
- stop the match, at their discretion, for any infringements of the Futsal Laws of the Game
- stop the match because of outside interference of any kind
- stop the match if, in their opinion, a player is seriously injured and ensure that he is removed from the pitch. An injured player may only return to the pitch after the match has restarted
- allow play to continue until the ball is out of play if a player is, in their opinion, only slightly injured
- ensure that any player bleeding from a wound leaves the pitch. The player may only return on receiving a signal from the referees, who must be satisfied, either directly or through the third referee, that the bleeding has stopped
- allow play to continue when the team against which an offence has been committed stands to benefit from such an advantage and penalise the original offence if the anticipated advantage does not ensue at that time
- punish the more serious offence when a player commits more than one offence at the same time
- punish the more serious misconduct when a player commits more than one act of misconduct at the same time

- take disciplinary action against players guilty of cautionable and sending-off offences. They are not obliged to take this action immediately but must do so when the ball next goes out of play
- take action against team officials who fail to conduct themselves in a responsible manner and may, at their discretion, expel them from the technical area and the surrounds of the pitch
- ensure that no unauthorised persons enter the pitch
- indicate the restart of the match after it has been stopped
- give the signals described in the section entitled “Referee and Assistant Referee Signals”
- position themselves on the pitch as described in the sections entitled “Positioning with ball in play” and “Positioning in ball out of play situations”, which are part of the “Interpretation of the Futsal Laws of the Game and Guidelines for Referees” (Law 5 – The Referees), when they are required to do so
- provide the appropriate authorities with a match report, which includes information on any sanctions imposed on players and/or team officials and any other incidents that occurred before, during or after the match

The referee:

- acts as timekeeper and third referee in the event that the assistant referees are not present
- suspends or abandons the match, at his discretion, for any infringements of the Futsal Laws of the Game
- suspends or abandons the match because of outside interference of any kind

The second referee:

- replaces the referee in the event that he becomes injured or indisposed

Decisions of the referees

The decisions of the referees regarding facts connected with play, including whether or not a goal is scored and the result of the match, are final.

The referees may only change a decision on realising that it is incorrect or, at their discretion, on the advice of an assistant referee, provided that they have not restarted play or terminated the match.

The decisions of the referee prevail over those of the second referee if both signal an infringement and there is disagreement between them.

In the event of undue interference or improper conduct, the referee will relieve the second referee or the assistant referees of their duties, arrange for them to be substituted and make a report to the appropriate authorities.

Responsibilities of the referees

The referees (or where applicable, the assistant referees) are not held liable for:

- any kind of injury suffered by a player, official or spectator
- any damage to property of any kind
- any other loss suffered by any individual, club, company, association or other body, which is due or which may be due to any decision that they may take under the terms of the Futsal Laws of the Game or in respect of the normal procedures required to hold, play and control a match

Such decisions may include:

- a decision that the condition of the pitch or its surrounds or that the weather conditions are such as to allow or not to allow a match to take place
- a decision to abandon a match for whatever reason
- a decision as to the suitability of the accessories and equipment used during a match
- a decision to stop or not to stop a match due to spectator interference or any problem in spectator areas

- a decision to stop or not to stop play to allow an injured player to be removed from the pitch for treatment
- a decision to require an injured player to be removed from the pitch for treatment
- a decision to allow or not to allow a player to wear certain apparel or equipment
- a decision (where they have the authority) to allow or not to allow any persons (including team or venue officials, security officers, photographers or other media representatives) to be present in the vicinity of the pitch
- any other decision that they may take in accordance with the Futsal Laws of the Game or in conformity with their duties under the terms of FIFA, confederation, member association or league rules or regulations under which the match is played

International matches

A second referee is mandatory for international matches.

Reserve assistant referee

In tournaments or competitions where a reserve assistant referee is appointed, his role and duties must be in accordance with the provisions stipulated in the Futsal Laws of the Game.

The authority of the assistant referees

Two assistant referees may be appointed (a third referee and a timekeeper) who must perform their duties in accordance with the Futsal Laws of the Game. They are positioned off the pitch, level with the halfway line and on the same side as the substitution zones. The timekeeper remains seated at the timekeeper's table, while the third referee may perform his duties either seated or standing up.

The timekeeper and the third referee are equipped with a suitable chronometer and the necessary equipment to keep a record of accumulated fouls, which is supplied by the association or club under whose jurisdiction the match is being played.

They are provided with a timekeeper's table in order to perform their duties correctly.

Powers and duties

The third referee:

- assists the referees and the timekeeper
- keeps a record of the players taking part in the match
- monitors the replacement of balls at the request of the referees
- checks the substitutes' equipment before they enter the pitch
- records the goalscorers' numbers
- informs the timekeeper of a request for a time-out when a team official makes one (see Law 7 – The Duration of the Match)
- gives the mandatory time-out signal once the timekeeper has sounded the acoustic signal, to inform the referees and the teams that the time-out has been granted
- keeps a record of the time-outs requested
- keeps a record of the accumulated fouls by each team signalled by the referees in each period of play

- gives the mandatory signal that one team has committed five accumulated fouls in a period of play
- places a visible sign on the timekeeper's table to indicate that a team has committed five accumulated fouls in one period of play
- records the names and numbers of any players cautioned or sent off
- hands a document to the officials of each team before the start of each period of play with which they can request time-outs and collects it at the end of each period if none have been requested



TIME-OUT TEMP MORT TIEMPO MUERTO AUSZEIT

- hands a document to the officials of each team which indicates when a substitute can enter the pitch to replace a player who has been sent off



THE SUBSTITUTE PLAYER WILL BE ABLE TO ENTER THE FIELD OF PLAY, WHEN THERE ARE ____ MINUTE(S) AND ____ SECOND(S) ON THE CHRONOMETER LEFT TO END THE ____ PERIOD.

LE JOUEUR SUBSTITUT POURRA ENTRER DANS LE TERRAIN DE JEU QUAND LE CHRONOMETRE INDIQUERA ____ MINUTE(S) ET ____ SECONDE(S) ____ POUR FINIR LA ____ PÉRIODE.

EL JUGADOR SUSTITUTO PODRÁ ENTRAR EN EL TERRENO DE JUEGO CUANDO EL CRONÓMETRO ESTÉ EN EL MINUTO ____ Y SEGUNDOS ____ PARA FINALIZAR EL ____ PERIODO.

DER ERSATZSPIELER KANN DAS SPIELFELD BETRETEN, WENN AUF DER ZEITMESSUNG NOCH ____ MINUTE(N) UND ____ SEKUNDE(N) FEHLEN, UM DIE ____ PERIODE ZU BEENDEN.

- under the referees' supervision, checks the entry of a player who has left the pitch to correct his equipment
- under the referees' supervision, checks the entry of a player who has left the pitch due to an injury of any kind
- signals to the referees when an obvious error has been made in cautioning or sending off a player or if an act of violence has been committed out of their field of vision. In any case, the referees decide on any facts connected with play
- supervises the conduct of the persons situated in the technical area, if any, and on the benches and informs the referees of any inappropriate behaviour
- keeps a record of stoppages in play because of outside interference and the reasons for them
- provides any other information relevant to the game
- positions himself on the pitch as described in the sections entitled "Positioning with ball in play" and "Positioning in ball out of play situations", which are part of the "Interpretation of the Futsal Laws of the Game and Guidelines for Referees" (Law 5 – The Referees), when he is required to do so
- replaces the second referee in the event that the referee or second referee becomes injured or indisposed

The timekeeper ensures that the duration of the match complies with the provisions of Law 7 by:

- starting the chronometer after a kick-off has been taken correctly
- stopping the chronometer when the ball is out of play
- restarting the chronometer after play has been correctly resumed after a kick-in, a goal clearance, a corner kick or kick-off, a free kick, kicks from the penalty mark or second penalty mark or a dropped ball
- recording the goals, accumulated fouls and periods of play on the public scoreboard, if available
- indicating a team's request for a time-out with a different whistle or acoustic signal from the one used by the referees, after the third referee has informed him
- timing the one-minute time-out

- indicating the end of the one-minute time-out with a different whistle or acoustic signal from the one used by the referees
- indicating the fifth accumulated foul by a team with a different whistle or acoustic signal from the one used by the referees, after the third referee has informed him
- times a player's two-minute expulsion
- indicates the end of the first half, the end of the match or the end of the periods of extra time, if any, with a different whistle or acoustic signal from the one used by the referees
- positions himself on the pitch as described in the sections entitled "Positioning with ball in play" and "Positioning in ball out of play situations", which are part of the "Interpretation of the Futsal Laws of the Game and Guidelines for Referees" (Law 5 – The Referees), when he is required to do so
- performs the specific duties of the third referee in the event of the latter's absence
- provides any other information relevant to the game

International matches

For international matches, the presence of a third referee and a timekeeper is mandatory.

For international matches, the chronometer used must incorporate all the necessary functions (precise timekeeping, a device to time the two-minute expulsion of four players simultaneously and monitor the accumulation of fouls by each team during each period of play).

Periods of play

The match lasts two equal periods of 20 minutes, unless otherwise mutually agreed between the referee and the two teams. Any agreement to alter the duration of the periods of play must be made before the start of play and must comply with the competition rules.

Ending the periods of play

The timekeeper indicates the end of each 20-minute period with an acoustic signal. After hearing the timekeeper's acoustic signal, one of the referees announces the end of the period or match with his whistle, bearing in mind the following:

- If a kick from the second penalty mark or direct free kick, beginning with the sixth accumulated foul, must be taken or retaken, the period in question is extended until the kick has been taken
- If a penalty kick has to be taken or retaken, the period in question is extended until the kick has been taken

If the ball has been played towards one of the goals before the timekeeper sounds the acoustic signal, the referees must wait for the kick to end before announcing the end of the period or match with a whistle. The period or match ends when:

- the ball goes directly into the goal and a goal is scored
- the ball leaves the boundaries of the pitch
- the ball touches the goalkeeper or another player in the defending team, the goalposts, crossbar or ground, crosses the goal line and a goal is scored
- the defending goalkeeper or another player in the defending team touches the ball or it rebounds from the goalposts or crossbar and does not cross the goal line
- the ball touches any player in the team that played the ball, except if an indirect free kick was taken and the ball was heading towards the opponent's goal after being touched by the second player
- no infringement has been committed that is sanctioned with a direct free kick, an indirect free kick or a penalty kick, and a direct free kick, indirect free kick or penalty kick does not have to be retaken

If an infringement has been committed during this period that is sanctioned with a direct free kick after the fifth accumulated foul of one of the teams, or sanctioned with a penalty kick, the period ends when:

- the ball is not kicked directly at the goal
- the ball goes directly into the goal and a goal is scored
- the ball leaves the boundaries of the pitch

- the ball hits one or both posts, the crossbar, the goalkeeper or another player in the defending team and a goal is scored
- the ball hits one or both posts, the crossbar, the goalkeeper or another player in the defending team and a goal is not scored
- no other infringement that is sanctioned with a direct free kick, indirect free kick or penalty kick is committed

If, during this period, an infringement sanctioned with a direct free kick is committed before the sixth accumulated foul of one of the teams, the period ends when:

- the ball is not kicked directly at the goal
- the ball goes directly into the goal and a goal is scored
- the ball leaves the boundaries of the pitch
- the ball hits one or both posts, the crossbar, the goalkeeper or another player in the defending team and a goal is scored
- the ball hits one or both posts, the crossbar, the goalkeeper or another player in the defending team and a goal is not scored
- the ball touches a player in the team taking the kick
- no other infringement that is sanctioned with a direct free kick, indirect free kick or penalty kick is committed

If an infringement sanctioned with an indirect free kick is committed during this period, the period ends when:

- the ball goes directly into the goal without being touched by another player during its trajectory or touching one or both of the posts or the crossbar, in which case the goal will not be allowed
- the ball leaves the boundaries of the pitch
- the ball hits one or both posts or the crossbar after touching the goalkeeper or another player in the defending or attacking team, not the player taking the kick, and a goal is scored
- the ball hits one or both posts or the crossbar after touching the goalkeeper or another player in the defending or attacking team, not the player taking the kick, and a goal is not scored
- no other infringement that is sanctioned with a direct free kick, indirect free kick or penalty kick is committed

Time-out

The teams are entitled to a one-minute time-out in each period.

The following conditions apply:

- The team officials are authorised to request the third referee, or the timekeeper if there is no third referee, for a one-minute time-out using the document provided
- The timekeeper grants the time-out when the team that has requested it is in possession of the ball and the ball is out of play, using a different whistle or acoustic signal from the ones used by the referees
- During the time-out, the players may remain on or off the pitch. In order to have a drink, the players must leave the pitch
- During the time-out, the substitutes must stay off the pitch
- During the time-out, officials are not allowed to give instructions on the pitch
- Substitutions may only be made after the acoustic signal or whistle has sounded to indicate the end of the time-out
- A team that does not request a time-out in the first period of the match is only entitled to one time-out during the second period
- If there is neither a third referee nor a timekeeper, a team official may request the referees for a time-out
- There are no time-outs during extra time, if played

Half-time interval

Players are entitled to an interval at half-time.

The half-time interval must not exceed 15 minutes.

Competition rules must state the duration of the half-time interval.

The duration of the half-time interval may be altered only with the consent of the referee.

Abandoned match

An abandoned match is replayed unless the competition rules provide otherwise.

Preliminaries

A coin is tossed and the team that wins the toss decides which goal it will attack in the first half of the match.

The other team takes the kick-off to start the match.

The team that wins the toss takes the kick-off to start the second half of the match.

In the second half of the match, the teams change ends and attack the opposite goals.

Kick-off

A kick-off is a way of starting or restarting play:

- at the start of the match
- after a goal has been scored
- at the start of the second half of the match
- at the start of each period of extra time, where applicable

A goal may not be scored directly from the kick-off.

Procedure

- All players must be in their own half of the pitch
- The opponents of the team taking the kick-off are at least 3 m from the ball until it is in play
- The ball must be stationary on the centre mark
- The referee gives a signal
- The ball is in play when it is kicked and moves forward

After a team scores a goal, provided that the period has not ended, the kick-off is taken by the other team.

Infringements and sanctions

If the ball is in play and the player taking the kick-off touches the ball again (except with his hands) before it has touched another player:

- an indirect free kick is awarded to the opposing team, to be taken from the position of the ball when the infringement occurred (see Law 13 – Position of free kick)

If the ball is in play and the player taking the kick-off deliberately handles the ball before it has touched another player:

- an indirect free kick is awarded to the opposing team, to be taken from the position of the ball when the infringement occurred (see Law 13 – Position of free kick) and his team is sanctioned with an accumulated foul

In the event of any other infringement of the kick-off procedure:

- the kick-off is retaken and the advantage cannot be applied

Dropped ball

If, while the ball is still in play, the referees are required to stop play temporarily for any reason not mentioned elsewhere in the Futsal Laws of the Game, the match is restarted with a dropped ball. The match is also restarted with a dropped ball when provided for in the Futsal Laws of the Game.

Procedure

The referee or second referee drops the ball from the position of the ball when play was stopped, unless play was stopped inside the penalty area, in which case one of the referees drops the ball on the penalty area line at the point nearest to where the ball was located when play was stopped.

Play restarts when the ball touches the ground within the boundaries of the pitch. If the ball leaves the pitch after it makes contact with the ground, without a player touching it after being in play, the ball is dropped at the same point where it was dropped the first time.

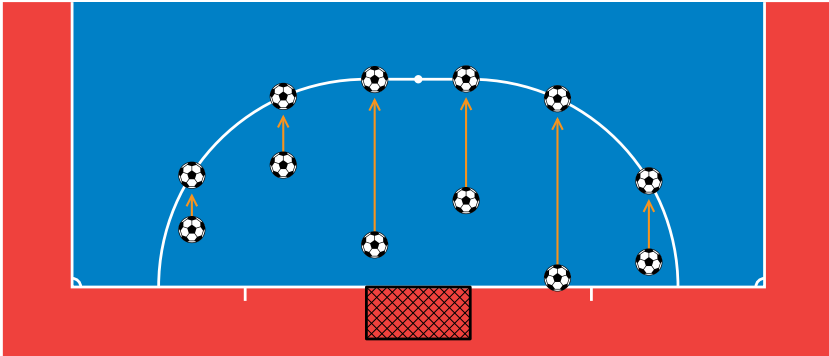

Infringements and sanctions

The ball is dropped again at the same place where it was dropped the first time:

- if it is touched by a player before it makes contact with the ground
- if the ball leaves the pitch after it makes contact with the ground without a player touching it
- if any infringement is committed before the ball makes contact with the ground

If, after the ball has made contact with the ground, a player kicks it once directly towards one of the goals and the ball goes directly

- into the opponent's goal, a goal clearance is awarded
- into the team's own goal, a corner kick is awarded to the opposing team

If, after the ball has made contact with the ground, a player kicks the ball with more than one touch towards one of the goals and:

- the ball enters one of the goals, a goal is awarded

Ball out of play

The ball is out of play when:

- it has wholly crossed the goal line or touch line whether on the ground or in the air
- play has been stopped by the referees
- it hits the ceiling

Ball in play

The ball is in play at all other times, including when:

- it rebounds off a goalpost or crossbar and remains on the pitch
- it rebounds off the referees when they are on the pitch

Indoor pitch

The minimum height of ceilings is 4m and shall be stipulated in the competition rules.

If the ball hits the ceiling while in play, the game is restarted with a kick-in taken by the opponents of the team that last touched the ball. The kick-in is taken from the point on the touch line nearest to the place on the ground above which the ball hit the ceiling (see Law 15 – Position of kick-in).

Goal scored

A goal is scored when the whole of the ball passes over the goal line, between the goalposts and under the crossbar, provided that no infringement of the Futsal Laws of the Game has been committed previously by the team scoring the goal.

A goal is disallowed if the goalkeeper of the attacking team throws or hits the ball intentionally with his hand or arm from inside his own penalty area and is the last player to touch or play the ball. The match is restarted with a goal clearance to the opposing team.

If, after a goal is scored, the referees realise, before play restarts, that the team that scored the goal was playing with an extra player or had carried out a substitution incorrectly, they must disallow the goal and restart play with an indirect free kick to be taken by the opponents of the offending player from any point inside the penalty area. If the kick-off has already been taken, they sanction the offending player in accordance with Law 3, but the goal is allowed. The referees report the fact to the appropriate authorities. If the goal was scored by the other team, they must allow it.

Winning team

The team scoring the greater number of goals during a match is the winner. If both teams score an equal number of goals, or if no goals are scored, the match is drawn.

Competition rules

When the competition rules require there to be a winning team after a match or home-and-away tie, the following are the only permitted procedures for determining the winning team:

- Away goals rule
- Extra time
- Kicks from the penalty mark

These procedures are described in the section entitled “Procedures to Determine the Winner of a Match or Home-and-Away Tie”.

There is no offside in futsal.

Fouls and acts of misconduct are infringements of the Futsal Laws of the Game that are penalised as follows:

Fouls

Fouls are penalised with a direct free kick, penalty kick or indirect free kick.

Fouls penalised with a direct free kick

A direct free kick is awarded to the opposing team if a player commits any of the following seven offences in a manner considered by the referees to be careless, reckless or using excessive force:

- Kicks or attempts to kick an opponent
- Trips an opponent
- Jumps at an opponent
- Charges an opponent
- Strikes or attempts to strike an opponent
- Pushes an opponent
- Tackles an opponent

A direct free kick is also awarded to the opposing team if a player commits any of the following three offences:

- Holds an opponent
- Spits at an opponent
- Handles the ball deliberately (except for the goalkeeper within his own penalty area)

A direct free kick is taken from the place where the offence occurred (see Law 13 – Position of free kick).

The above offences are accumulated fouls.

Fouls penalised with a penalty kick

A penalty kick is awarded if any of the above ten offences is committed by a player inside his own penalty area, irrespective of the position of the ball, provided it is in play.

Fouls penalised with an indirect free kick

An indirect free kick is awarded to the opposing team if a goalkeeper commits any of the following four offences:

- Controls the ball with his hands or feet in his own half of the pitch for more than four seconds
- After playing the ball, he touches it again in his own half of the pitch after it has been deliberately played to him by a team-mate without an opponent playing or touching it
- Touches the ball with his hands inside his own penalty area after it has been deliberately kicked to him by a team-mate
- Touches the ball with his hands inside his own penalty area after he has received it directly from a kick-in by a team-mate

An indirect free kick is also awarded to the opposing team if, in the opinion of the referees, a player:

- plays in a dangerous manner in the presence of an opponent
- impedes the progress of an opponent
- prevents the goalkeeper from releasing the ball from his hands
- commits against a team-mate one of the nine offences penalised with a direct free kick if they are committed against an opponent
- commits any other infringement not previously mentioned in Law 12 or in any other Law, for which play is stopped to caution or dismiss a player

The indirect free kick is taken from the place where the offence occurred (see Law 13 – Position of free kick).

Misconduct

Misconduct is penalised with a caution or a sending-off.

Disciplinary sanctions

The yellow card is used to communicate that a player or substitute has been cautioned.

The red card is used to communicate that a player or substitute has been sent off.

Only a player or substitute may be shown the red or yellow card. The relevant card is only shown publicly on the pitch if the match has started. In other cases, the referees verbally inform the players and team officials of the disciplinary sanction taken.

The referees have the authority to take disciplinary sanctions from the moment they enter the premises where the pitch is located before the start of the match until they leave them.

A player who commits a cautionable or sending-off offence, either on or off the pitch, whether directed towards an opponent, a team-mate, the referees or any other person, is disciplined according to the nature of the offence committed.

Cautionable offences

A player is cautioned if he commits any of the following seven offences:

- Unsporting behaviour
- Dissent by word or action
- Persistent infringement of the Futsal Laws of the Game
- Delaying the restart of play

- Failure to respect the required distance when play is restarted with a corner kick, free kick or kick-in (defending players)
- Entering or re-entering the pitch without the referees' permission or in contravention of the substitution procedure
- Deliberately leaving the pitch without the referees' permission

A substitute is cautioned if he commits any of the following four infringements:

- Unsporting behaviour
- Dissent by word or action
- Delaying the restart of play
- Entering the pitch in contravention of the substitution procedure

Sending-off offences

A player or substitute is sent off if he commits any of the following seven offences:

- Serious foul play
- Violent conduct
- Spitting at an opponent or any other person
- Denying the opposing team a goal or an obvious goalscoring opportunity by deliberately handling the ball (this does not apply to a goalkeeper within his own penalty area)
- Denying an obvious goalscoring opportunity to an opponent moving towards the player's goal by an offence punishable by a free kick or a penalty kick
- Using offensive, insulting or abusive language and/or gestures
- Receiving a second caution in the same match

A substitute is sent off if he commits the following offence:

- Denying a goal or an obvious goalscoring opportunity

A player or substitute who has been sent off must leave the vicinity of the pitch and the technical area.

Types of free kick

Free kicks are either direct or indirect.

The direct free kick

Signal

One of the referees signals the direct free kick by keeping one arm horizontal and pointing in the direction the kick has to be taken. The referee points to the ground with his other hand to make it plain to the third referee and the timekeeper that it is an accumulated foul.

Ball enters the goal

- If a direct free kick is kicked directly into the opponents' goal, a goal is awarded
- If a direct free kick is kicked directly into the team's own goal, a corner kick is awarded to the opposing team

Accumulated fouls

- Accumulated fouls are those penalised with a direct free kick or penalty kick mentioned in Law 12
- The accumulated fouls committed by each team in each period are recorded in the match report
- The referees may allow play to continue by applying the advantage if the team has not previously committed five accumulated fouls and the opposing team is not denied a goal or an obvious goalscoring opportunity
- If they apply the advantage, the referees use the mandatory signals to indicate an accumulated foul to the timekeeper and third referee as soon as the ball is out of play
- If extra time is played, accumulated fouls from the second period continue to accumulate during extra time

The indirect free kick

Signal

The referees indicate an indirect free kick by raising their arms above their heads. They maintain their arms in that position until the kick has been taken and the ball has touched another player or goes out of play.

Ball enters the goal

A goal can be scored only if the ball subsequently touches another player before it enters the goal.

- If an indirect free kick is kicked directly into the opponents' goal, a goal clearance is awarded
- If an indirect free kick is kicked directly into the team's own goal, a corner kick is awarded to the opposing team

Procedure

For both direct and indirect free kicks, the ball must be stationary when the kick is taken.

Direct free kick beginning with the sixth accumulated foul by each team

- The player taking the free kick kicks the ball with the intention of scoring a goal and may not pass the ball to a team-mate
- Once the free kick has been taken, no player may touch the ball until it has been touched by the defending goalkeeper, rebounded off one of the goalposts or the crossbar, or left the pitch
- If a player commits his team's sixth accumulated foul in the opposing team's half or in his own half in the area bordered by the halfway line and an imaginary line parallel to the halfway line passing through the second penalty mark, the free kick is taken from the second penalty mark. The location of the second penalty mark is indicated in Law 1. The free kick is taken in accordance with the section entitled "Position of free kick"

- If a player commits his team's sixth accumulated foul in his own half of the pitch between the imaginary 10m line and the goal line but outside the penalty area, the attacking team decides whether to take it from the second penalty mark or the place where the infringement occurred
- Beginning with the sixth accumulated foul, additional time is allowed to take a direct free kick at the end of each half or at the end of each period of extra time

Position of free kick

Free kick outside the penalty area

- All opponents must be at least 5m from the ball until it is in play
- The ball is in play when it is kicked and moves
- The free kick is taken from the place where the infringement occurred or from the position of the ball when the infringement occurred (according to the infringement) or from the second penalty mark

Direct or indirect free kick inside the penalty area to the defending team

- All opponents must be at least 5m from the ball until it is in play
- All opponents must remain outside the penalty area until the ball is in play
- The ball is in play when it is kicked directly out of the penalty area
- A free kick awarded in the penalty area may be taken from any point inside that area

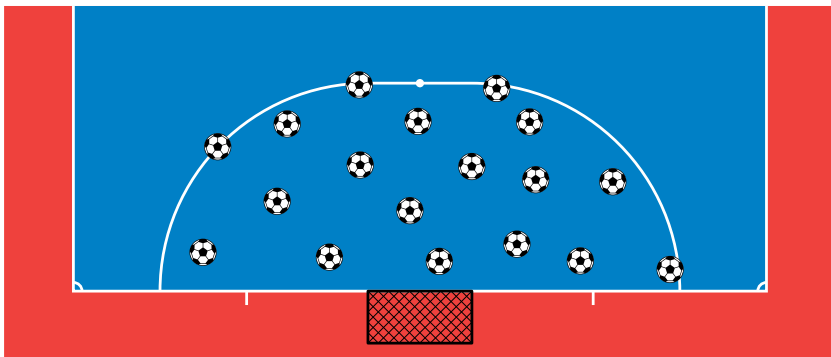

Direct free kick beginning with the sixth accumulated foul in each period

- The defending team's players may not form a wall to defend free kicks
- The player taking the kick is properly identified
- The goalkeeper remains in his penalty area at a distance of at least 5m from the ball
- The players remain on the pitch, except the kicker if he wishes
- The players, except the kicker and the defending goalkeeper, remain behind an imaginary line that is level with the ball and parallel to the goal line and outside the penalty area, at a distance of 5m from the ball. They may not obstruct the player taking the free kick. No player, except the kicker, may cross this imaginary line until the ball is in play

Indirect free kick for the attacking team

- All opponents must be at least 5m from the ball until it is in play
- The ball is in play when it is kicked and moves
- An indirect free kick conceded in the penalty area is taken from the penalty area line at the point nearest to where the offence was committed

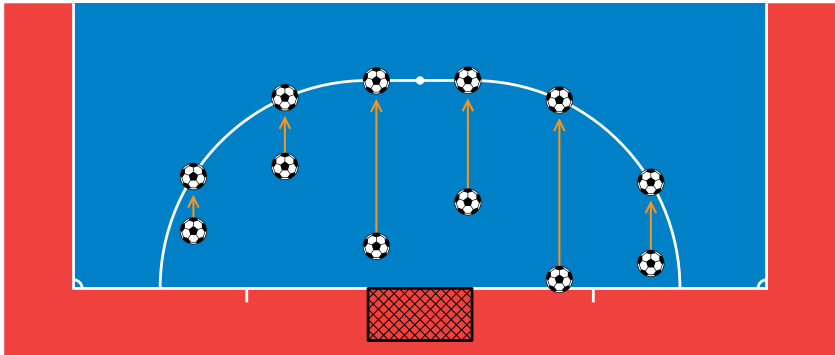

Infringements and sanctions

If, when a free kick is taken, an opponent is closer to the ball than the required distance:

- the kick is retaken and the offending player is cautioned, unless the advantage can be applied or another infringement is committed that is punishable by a penalty kick. If the infringement is punishable by a free kick, the referees decide whether to punish the original infringement or the one committed subsequently. If the second infringement is punishable by a penalty kick or direct free kick, an accumulated foul is recorded against the offending team

If, when a free kick is taken by the defending team from inside its own penalty area, the ball is not kicked directly out of the penalty area:

- the kick is retaken

If the team taking the free kick takes more than four seconds:

- the referees award an indirect free kick to the opposing team, to be taken from the place where play was to be restarted (see Law 13 – Position of free kick)

Beginning with the sixth accumulated foul, if the player taking the kick does not do so with the intention of scoring a goal:

- the referees award an indirect free kick to the opposing team, to be taken from the place where play was to be restarted

Beginning with the sixth accumulated foul, if a free kick is taken by a teammate of the player who had been identified previously:

- the referees stop play, caution him for unsporting behaviour and restart the match with an indirect free kick to the defending team to be taken from where he kicked the ball

Free kick taken by a player other than the goalkeeper

If, after the ball is in play, the kicker touches the ball again (except with his hands) before it has touched another player:

- an indirect free kick is awarded to the opposing team, to be taken from the place where the infringement occurred (see Law 13 – Position of free kick)

If, after the ball is in play, the kicker deliberately handles the ball before it has touched another player:

- a direct free kick is awarded to the opposing team, to be taken from the place where the infringement occurred (see Law 13 – Position of free kick), and his team is sanctioned with an accumulated foul
- a penalty kick is awarded if the infringement was committed inside the kicker's penalty area, and his team is sanctioned with an accumulated foul

Free kick taken by the goalkeeper

If, after the ball is in play, the goalkeeper touches the ball again (except with his hands) before it has touched another player:

- an indirect free kick is awarded to the opposing team, to be taken from the place where the infringement occurred (see Law 13 – Position of free kick)

If, after the ball is in play, the goalkeeper deliberately handles the ball before it has touched another player:

- a direct free kick is awarded to the opposing team if the infringement occurred outside the goalkeeper's penalty area, to be taken from the place where the infringement occurred (see Law 13 – Position of free kick) and his team is sanctioned with an accumulated foul
- an indirect free kick is awarded to the opposing team if the infringement occurred inside the goalkeeper's penalty area, to be taken from the place where the infringement occurred (see Law 13 – Position of free kick)

If the referees give the signal to take the direct free kick, beginning with the sixth accumulated foul, and before the ball is in play, and:

a player of the team taking the kick infringes the Futsal Laws of the Game, except if the kicker takes longer than four seconds:

- the referees allow the kick to be taken
- if the ball enters the goal, the kick is retaken
- if the ball does not enter the goal, the referees stop play and order the match to be restarted with an indirect free kick to the defending team, to be taken from the place where the infringement occurred (see Law 13 – Position of free kick)

a player of the defending team infringes the Futsal Laws of the Game:

- the referees allow the kick to be taken
- if the ball enters the goal, a goal is awarded
- if the ball does not enter the goal, the kick is retaken

one or more players of the defending team and one or more players of the attacking team infringe the Futsal Laws of the Game:

- the kick is retaken

Beginning with the sixth accumulated foul, if, after the direct free kick has been taken:

the kicker does not kick the ball forward with the intention of scoring a goal:

- the referees stop play and order the match to be restarted with an indirect free kick to the defending team, to be taken from the place where the offence occurred (see Law 13 – Position of free kick)

the kicker touches the ball again (except with his hands) before it has touched another player:

- an indirect free kick is awarded to the opposing team, to be taken from the place where the infringement occurred (see Law 13 – Position of free kick)

a different player from the kicker touches the ball (except with his hands) before it has touched the defending goalkeeper, rebounded off one of the goalposts or the crossbar or left the pitch:

- an indirect free kick is awarded to the opposing team, to be taken from the place where the infringement occurred (see Law 13 – Position of free kick)

a player deliberately handles the ball:

- a direct free kick is awarded to the opposing team, to be taken from the place where the infringement occurred (see Law 13 – Position of free kick) and his team is sanctioned with an accumulated foul
- a penalty kick is awarded if the infringement was committed by a player from the defending team inside his own penalty area, except for the defending goalkeeper (see Law 13 – Position of free kick) and his team is sanctioned with an accumulated foul

the ball is touched by an outside agent as it moves forward:

- the kick is retaken

the ball rebounds on to the pitch from the goalkeeper, the crossbar or the goalposts, and is then touched by an outside agent:

- the referees stop play
- play is restarted with a dropped ball at the place where it touched the outside agent, unless it touched the outside agent inside the penalty area, in which case one of the referees drops the ball on the penalty area line at the point nearest to where the ball was located when play was stopped

the ball bursts or becomes defective while in play and has not previously touched the goalposts, the crossbar or another player:

- the kick is retaken

A penalty kick is awarded against a team that commits any of the ten offences for which a direct free kick is awarded, inside its own penalty area and while the ball is in play.

A goal may be scored directly from a penalty kick.

Additional time is allowed for a penalty kick to be taken at the end of each half or at the end of each period of extra time.

Position of the ball and the players

The ball:

- must be placed on the penalty mark

The player taking the penalty kick:

- must be properly identified

The defending goalkeeper:

- must remain on his goal line, facing the kicker, between the goalposts until the ball has been kicked

The players other than the kicker must be located:

- on the pitch
- outside the penalty area
- behind the penalty mark
- at least 5m from the penalty mark

Procedure

- After the players have taken positions in accordance with this Law, one of the referees signals for the penalty kick to be taken
- The player taking the penalty kick must kick the ball forward
- The ball is in play when it is kicked and moves forward

When a penalty kick is taken during the normal course of play, or time has been extended at half-time or full time or at the end of a period of extra time, if any, to allow a penalty kick to be taken or retaken, a goal is awarded if, before passing between the goalposts and under the crossbar:

- the ball touches either or both goalposts and/or the crossbar and/or the goalkeeper

The referees decide when a penalty kick has been completed.

Infringements and sanctions

If the player taking the penalty kick does not kick the ball forward:

- the referees stop play and order the match to be restarted with an indirect free kick to the defending team, to be taken from the penalty mark (see Law 13 – Position of free kick)

If, while a penalty kick is being taken, the ball is kicked by a team-mate of the player who had been previously identified:

- the referees stop play, caution him for unsporting behaviour and order the match to be restarted with an indirect free kick to the defending team, to be taken from the penalty mark (see Law 13 – Position of free kick)

If the referees give the signal for the penalty kick to be taken and, before the ball is in play, one of the following occurs:

a player of the same team as the player taking the kick infringes the Futsal Laws of the Game:

- the referees allow the kick to be taken
- if the ball enters the goal, the kick is retaken
- if the ball does not enter the goal, the referees stop play and order the match to be restarted with an indirect free kick to the defending team, to be taken from the place where the offence occurred (see Law 13 – Position of free kick)

a player of the defending team infringes the Futsal Laws of the Game:

- the referees allow the kick to be taken
- if the ball enters the goal, a goal is awarded
- if the ball does not enter the goal, the kick is retaken

one or more players of the defending team and one or more players of the attacking team infringe the Futsal Laws of the Game:

- the kick is retaken

If, after the penalty kick has been taken:

the kicker touches the ball again (except with his hands) before it has touched another player:

- an indirect free kick is awarded to the opposing team, to be taken from the place where the infringement occurred (see Law 13 – Position of free kick)

the kicker deliberately handles the ball before it has touched another player:

- a direct free kick is awarded to the opposing team, to be taken from the place where the infringement occurred (see Law 13 – Position of free kick) and his team is sanctioned with an accumulated foul

the ball is touched by an outside agent as it moves forward:

- the kick is retaken

the ball rebounds on to the pitch from the goalkeeper, the crossbar or the goalposts, and is then touched by an outside agent:

- the referees stop play
- play is restarted with a dropped ball at the place where it touched the outside agent, unless it touched the outside agent inside the penalty area, in which case one of the referees drops the ball on the penalty area line at the point nearest to where the ball was located when play was stopped

the ball bursts or becomes defective when in play and has not previously touched the goalposts, the crossbar or a player:

- the kick is retaken

A kick-in is a method of restarting play.

A kick-in is awarded to the opponents of the player who last touches the ball when the whole of the ball crosses the touch line, either on the ground or in the air, or touches the ceiling of the hall.

A goal may not be scored directly from a kick-in.

Position of the players

The opponents must be:

- on the pitch
- at a distance of no less than 5m from the place on the touch line where the kick-in is taken

Procedure

There is one type of procedure:

- kick-in

Position of kick-in

At the moment of delivering the ball, the kicker:

- has one foot on the touch line or on the ground outside the pitch
- kicks the ball, which must be stationary, either from the point where it left the pitch or on the ground outside it at a distance no greater than 25cm from that point
- delivers the ball within four seconds of being ready to do so

The ball is in play when it enters the pitch.

Infringements and sanctions

If, when a kick-in is taken, an opponent is closer to the ball than the required distance:

- the kick-in is retaken by the same team and the offending player is cautioned, unless the advantage can be applied or an offence punishable by a free kick or penalty kick is committed by the opposing team of the player taking the kick-in

If an opponent unfairly distracts or impedes the player taking the kick-in:

- he is cautioned for unsporting behaviour

For any other infringement of the procedure for the kick-in:

- the kick-in is taken by a player of the opposing team

Kick-in taken by a player other than the goalkeeper

If the ball is in play and the player taking the kick-in touches the ball again (except with his hands) before it has touched another player:

- an indirect free kick is awarded to the opposing team, to be taken from the place where the infringement occurred (see Law 13 – Position of free kick)

If the ball is in play and the player taking the kick-in deliberately handles the ball before it has touched another player:

- a direct free kick is awarded to the opposing team, to be taken from the place where the infringement occurred (see Law 13 – Position of free kick) and his team is sanctioned with an accumulated foul
- a penalty kick is awarded if the infringement is committed inside the penalty area of the player taking the kick-in and his team is sanctioned with an accumulated foul

Kick-in taken by the goalkeeper

If the ball is in play and the goalkeeper touches the ball again (except with his hands) before it has touched another player:

- an indirect free kick is awarded to the opposing team, to be taken from the place where the infringement occurred (see Law 13 – Position of free kick)

If the ball is in play and the goalkeeper deliberately handles the ball before it has touched another player:

- a direct free kick is awarded to the opposing team if the infringement occurred outside the goalkeeper's penalty area, to be taken from the place where the infringement occurred (see Law 13 – Position of free kick) and his team is sanctioned with an accumulated foul
- an indirect free kick is awarded to the opposing team if the infringement occurred inside the goalkeeper's penalty area, to be taken from the penalty area line at the point nearest to where the infringement occurred (see Law 13 – Position of free kick)

The goal clearance is a method of restarting play.

A goal clearance is awarded when the whole of the ball passes over the goal line, either on the ground or in the air, having last touched a player of the attacking team, and a goal is not scored in accordance with Law 10.

A goal may not be scored directly from a goal clearance.

Position of the players

The opponents must be:

- on the pitch and outside the penalty area of the team taking the goal clearance until the ball is in play

Procedure

- The ball is thrown from any point inside the penalty area by the goalkeeper of the defending team
- The goalkeeper of the defending team takes the goal clearance within four seconds of being ready to do so
- The ball is in play when it is thrown directly out of the penalty area by the goalkeeper of the defending team

Infringements and sanctions

If the ball is not thrown directly out of the penalty area from a goal clearance:

- the clearance is retaken, but the four-second count is not reset and continues once the goalkeeper is ready to retake it

If the ball is in play and the goalkeeper touches the ball again (except with his hands) before it has touched another player:

- an indirect free kick is awarded to the opposing team, to be taken from the place where the infringement occurred (see Law 13 – Position of free kick)

If the ball is in play and the goalkeeper deliberately handles the ball before it has touched another player:

- a direct free kick is awarded to the opposing team if the infringement occurred outside the goalkeeper's penalty area, to be taken from the place where the infringement occurred (see Law 13 – Position of free kick) and his team is sanctioned with an accumulated foul
- an indirect free kick is awarded to the opposing team if the infringement occurred inside the goalkeeper's penalty area, to be taken from the penalty area line at the point nearest to where infringement occurred (see Law 13 – Position of free kick)

If the ball is in play and the goalkeeper touches it again in his own half of the pitch after it has been deliberately played to him by a team-mate without an opponent playing or touching it:

- an indirect free kick is awarded to the opposing team, to be taken from the place where the infringement occurred (see Law 13 – Position of free kick)

If the goal clearance is not taken within four seconds:

- an indirect free kick is awarded to the opposing team, to be taken from the penalty area line at the place nearest to where the infringement occurred (see Law 13 – Position of free kick)

If the goal clearance is taken with attacking players inside the penalty area:

- the clearance is retaken if any of the attacking players touches the ball or prevents the clearance from being taken properly

In the event of any other infringements of this Law:

- the goal clearance is retaken. If the infringement has been committed by the team taking the clearance, the four-second count is not reset and continues once the goalkeeper is ready to retake the clearance

The corner kick is a method of restarting play.

A corner kick is awarded when the whole of the ball passes over the goal line, either on the ground or in the air, having last touched a player of the defending team, and a goal is not scored in accordance with Law 10.

A goal may be scored directly from a corner kick, but only against the opposing team.

Position of the ball and the players

The ball must be:

- inside the corner arc nearest to the point where the ball crossed the goal line

The opponents must be:

- on the pitch at least 5m from the corner arc until the ball is in play

Procedure

- The ball must be kicked by a player of the attacking team
- The team taking the kick must deliver the ball within four seconds of being ready to do so
- The ball is in play when it is kicked and moves

Infringements and sanctions

If, when a corner kick is taken, an opponent is closer to the ball than the required distance:

- the corner kick is retaken by the same team and the offending player is cautioned, unless the advantage can be applied or an offence punishable by a free kick or penalty kick is committed by the defending team

If an opponent unfairly distracts or impedes the player taking the corner kick:

- he is cautioned for unsporting behaviour

If the corner kick is not taken within four seconds:

- a goal clearance is awarded to the opposing team

In the event of any other infringement of the procedure or the position of the ball:

- the kick is retaken. If the infringement has been committed by the team taking the kick, the four-second count is not reset and continues once the kicker is ready to retake the kick

Corner kick taken by a player other than the goalkeeper

If the ball is in play and the player taking the kick touches the ball again (except with his hands) before it has touched another player:

- an indirect free kick is awarded to the opposing team, to be taken from the place where the infringement occurred (see Law 13 – Position of free kick)

If the ball is in play and the kicker deliberately handles the ball before it has touched another player:

- a direct free kick is awarded to the opposing team, to be taken from the place where the infringement occurred (see Law 13 – Position of free kick), and his team is sanctioned with an accumulated foul
- a penalty kick is awarded if the infringement was committed inside the penalty area of the player taking the kick and his team is sanctioned with an accumulated foul

Corner kick taken by the goalkeeper

If the ball is in play and the goalkeeper touches the ball again (except with his hands) before it has touched another player:

- an indirect free kick is awarded to the opposing team, to be taken from the place where the infringement occurred (see Law 13 – Position of free kick)

If the ball is in play and the goalkeeper deliberately handles the ball before it has touched another player:

- a direct free kick is awarded to the opposing team if the infringement occurred outside the goalkeeper's penalty area, to be taken from the place where the infringement occurred (see Law 13 – Position of free kick), and his team is sanctioned with an accumulated foul
- an indirect free kick is awarded to the opposing team if the infringement occurred inside the goalkeeper's penalty area, to be taken from the place where the infringement occurred (see Law 13 – Position of free kick)

Away goals, extra time and kicks from the penalty mark are the three methods approved for determining the winning team where competition rules require there to be a winning team after a match has been drawn. Extra time and kicks from the penalty mark are not part of the match.

Away goals

Competition rules may provide that where teams play each other home and away, if the aggregate score is equal after the second match, any goals scored on the pitch of the opposing team will count double.

Extra time

Competition rules may provide for two further equal periods, of three or five minutes each, to be played. The conditions of Law 8 will apply. The competition regulations must state the precise duration of the two equal periods of extra time.

Kicks from the penalty mark

Competition rules may provide for kicks from the penalty mark in accordance with the procedure stipulated below.

Procedure

- The referee chooses the goal at which the kicks will be taken
- The referee tosses a coin and the team whose captain wins the toss decides whether to take the first or the second kick
- The referee, the second referee, the third referee and the timekeeper keep a record of the kicks being taken
- Subject to the conditions explained below, both teams take three kicks
- The kicks are taken alternately by the teams
- If, before both teams have taken three kicks, one has scored more goals than the other could score even if it were to complete its three kicks, no more kicks are taken

- If, after both teams have taken three kicks, both have scored the same number of goals, or have not scored any goals, kicks continue to be taken in the same order until one team has scored a goal more than the other from the same number of kicks
- All players and substitutes are authorised to take the penalty kicks
- A goalkeeper may be replaced by any player while kicks are being taken from the penalty mark
- Each kick is taken by a different player and all eligible players must take a kick before any player can take a second kick
- An eligible player may change places with the goalkeeper at any time when kicks from the penalty mark are being taken, provided that the referee is informed and his equipment is suitable
- Only the eligible players, including the goalkeepers, the referees and the third referee are permitted to remain on the pitch when kicks from the penalty mark are being taken
- All eligible players, except the player taking the kick and the two goalkeepers, must remain in the opposite half of the pitch with the third referee
- The goalkeeper who is the team-mate of the kicker must remain on the opposite side to the substitution zones, on the pitch level with the penalty mark and at least 5m from it
- Unless otherwise stated, the Futsal Laws of the Game and guidelines of the FIFA Refereeing Department apply when kicks from the penalty mark are being taken
- If, at the end of the match or extra time and before the kicks start to be taken from the penalty mark, one team has a greater number of players, including substitutes, than its opponents, it must reduce its numbers to equate with that of its opponents and the team captain must inform the referee of the name and number of each player excluded
- If a team must reduce its numbers to equate with that of its opponents, it may exclude the goalkeepers as players eligible to take the penalty kicks
- A goalkeeper excluded from taking penalty kicks in order to equate the number of players of his team with that of its opponents, i.e. who is located in his technical area, may replace his team's goalkeeper at any time

- Before the start of the kicks from the penalty mark, the referee must ensure that an equal number of players from each team eligible to take the penalty kicks remains in the other half of the pitch

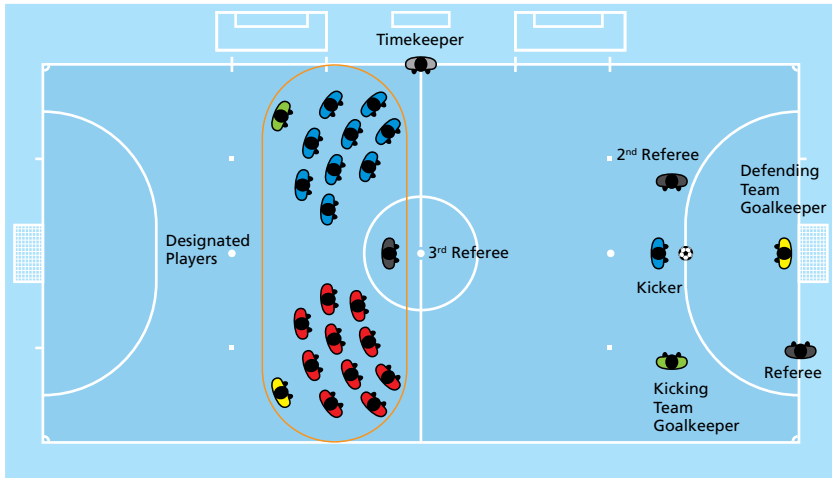

The technical area is a special zone for technical staff and substitutes.

While the size and position of technical areas may differ between facilities, the following notes are issued for general guidance:

- The technical area extends 1m on either side of the designated seated area and extends forward up to a distance of 75cm from the touch line
- It is recommended that markings are used to define this area
- The number of persons permitted to occupy the technical area is defined by the competition rules
- The occupants of the technical area are identified before the beginning of the match in accordance with the competition rules
- Only one team official at a time is authorised to convey tactical instructions and may remain standing
- The coach and other officials must remain within the confines of the technical area except in special circumstances, e.g. a physiotherapist or doctor entering the pitch, with the referees' permission, to assess an injured player or organise his removal from the pitch
- The coach and other occupants of the technical area must behave in a responsible manner, avoiding any obstruction of the players' and referees' movements

- The substitutes and the fitness coach may warm up during a match in the zone provided for this purpose, as long as they do not obstruct the movements of players and referees and they behave responsibly

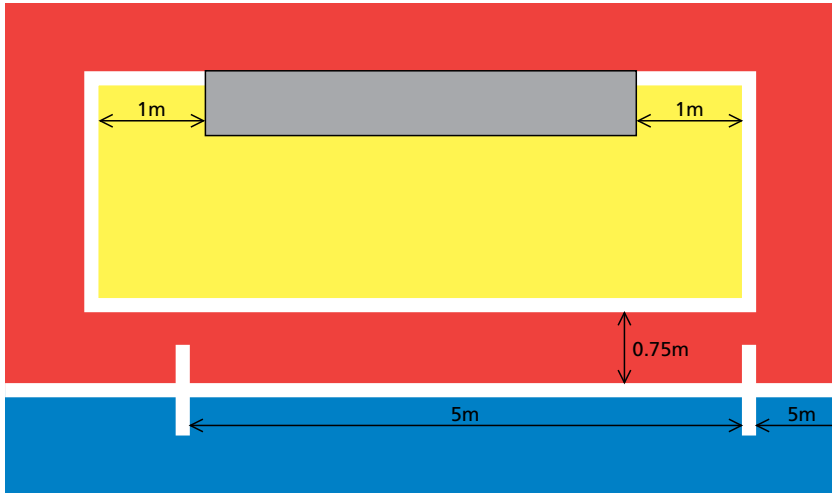

The reserve assistant referee:

- is appointed under the competition rules and replaces the timekeeper if any of the referees is unable to continue officiating the match. He assists the referees at all times
- assists with any administrative duties before, during and after the match, as required by the referees
- submits a report after the match to the appropriate authorities on any misconduct or other incident that occurred out of the view of the referees. He must advise the referees of any report being made
- records all incidents occurring before, during and after the match
- carries an alternative manual chronometer in case it is required due to an incident of any kind
- is situated in a prominent place, but not next to the assistant referees

The referees must give the signals listed below, bearing in mind that there are signals that only one of the referees must make and one signal that both referees must make at the same time.

The assistant referees must give the signals for a time-out and the fifth accumulated foul.

Signals by only one of the referees



Kick-off/restart of play

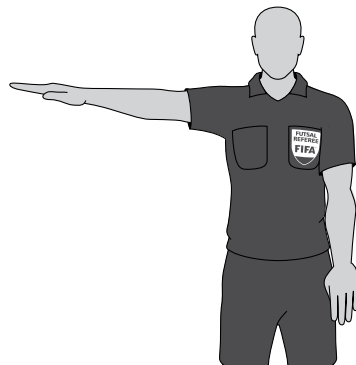
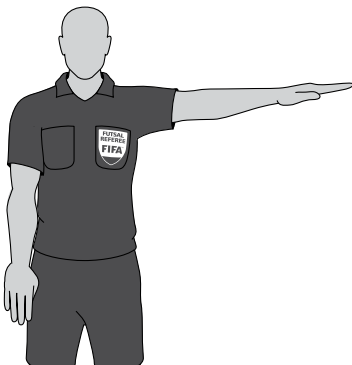

Direct free kick/penalty kick



Kick-in (1)



Kick-in (2)



Corner kick (1)



Corner kick (2)

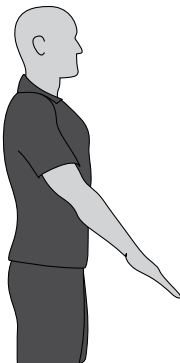

Goal clearance (1)

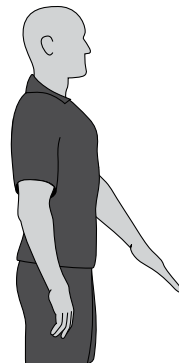

Goal clearance (2)



Time-out



Four-second count (1)



Four-second count (2)



Fifth accumulated foul

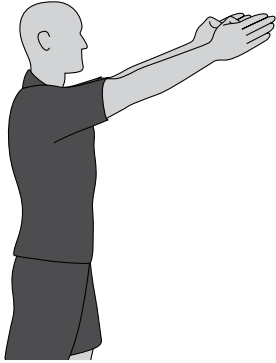

Advantage after accumulated foul

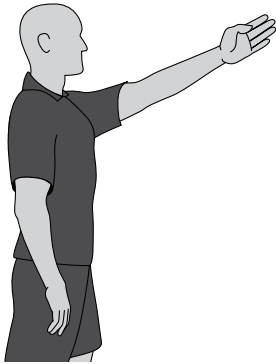

Advantage after non-accumulated foul



Accumulated foul after the advantage has been applied (1)



Accumulated foul after the advantage has been applied (2)



Accumulated foul after
the advantage has been applied (3)



Accumulated foul after
the advantage has been applied (4)



Caution (yellow card)



Sending-off (red card)



Indirect free kick



Number of player – 1



Number of player – 2



Number of player – 3



Number of player – 4



Number of player – 5



Number of player – 6



Number of player – 7



Number of player – 8



Number of player – 9



Number of player – 10



Number of player – 11



Number of player – 12



Number of player – 13



Number of player – 14



Number of player – 15



Goal



Own goal (1)



Own goal (2)

Signal by both referees on restarting play



Indirect free kick

Signals by the assistant referees



Time-out



Fifth accumulated foul

INTERPRETATION

of the Futsal
Laws of the Game and
Guidelines for Referees

Pitch surface

Matches must be played on flat surfaces, according to the rules of the competition.

Artificial turf

The use of artificial turf is not permitted in competition matches between representative teams of member associations affiliated to FIFA or international club competition matches.

Pitch markings

It is not permissible to mark the pitch with broken lines.

If a player makes unauthorised marks on the pitch, he must be cautioned for unsporting behaviour. If the referees notice this being done during the match, they must stop play if they cannot apply the advantage, caution the offending player for unsporting behaviour and order play to be restarted with an indirect free kick to the opposing team from the position of the ball when play was stopped (see Law 13 – Position of free kick).

An attempt should be made to use only the lines stipulated in Law 1 to mark the pitch, but since futsal is usually played in halls equipped for various sports, lines other than those used for football must be accepted, provided that they do not confuse the players and referees.

No lines or markings are allowed within 5m of the second penalty mark and inside the penalty area to indicate the distance that the defending goalkeeper must retreat while a kick from the second penalty mark is being taken.

Goals

If the crossbar becomes displaced or broken, play is stopped until it has been repaired or replaced in position. If it is not possible to repair the crossbar, the match must be abandoned. The use of a rope to replace the crossbar is not permitted. If the crossbar can be repaired, the match is restarted with a

dropped ball from the position of the ball when play was stopped, unless play was stopped inside the penalty area, in which case one of the referees drops the ball on the penalty area line at the point nearest to where the ball was located when play was stopped.

Safety

The competition rules shall state the distance that must exist between the boundary lines of the pitch (touch lines and goal lines) and the barriers separating the spectators, but always in such a way as to protect the participants' safety.

Advertising on the pitch

If the competition rules do not prohibit it, advertising on the floor of the pitch is permitted, provided that it does not confuse the players or referees and it enables the boundary lines stipulated in the Futsal Laws of the Game to be seen.

Advertising on the goal nets

If the competition rules do not prohibit it, advertising on the goal nets is permitted, provided that it does not confuse the players or referees.

Advertising in the technical areas

If the competition rules do not prohibit it, advertising on the floor of the technical areas is permitted, provided that it does not confuse the occupants of said areas, the third referee or the referees.

Commercial advertising around the pitch

Upright advertising shall be at least:

1. 1m from the touch lines, except in the technical area and substitution zones, in which all advertising is prohibited
2. the same distance from the goal line as the depth of the goal net
3. 1m from the goal net

Additional balls

Additional balls may be placed around the pitch for use during a match provided that they meet the requirements of Law 2 and their use is under the control of the referees.

Extra balls on the pitch

If an extra ball enters the pitch while the ball is in play, the referees must stop the match only if the extra ball interferes with play. Play must be restarted with a dropped ball from the position of the ball when play was stopped, unless play was stopped inside the penalty area, in which case one of the referees drops the ball on the penalty area line at the point nearest to where the ball was located when play was stopped.

If an extra ball enters the pitch while the ball is in play without interfering with play, the referees must have it removed at the earliest possible opportunity.

Burst or defective ball

If the ball bursts or becomes defective after striking one of the goalposts or the crossbar and enters the goal, the referees award the goal.

Substitution procedure

- A substitution may be made during play or during a stoppage in play, except during a time-out
- The player being substituted does not need to obtain the referees' permission to leave the pitch
- The referees do not need to authorise the substitute to enter the pitch
- Before entering the pitch, the substitute waits for the player he is replacing to leave the pitch
- The player being substituted is required to leave the pitch via his own team's substitution zone, except if he is already outside the pitch with the referees' permission or for the reasons provided in Laws 3 or 4
- Permission to proceed with a substitution may be refused under certain circumstances, e.g. if the substitute does not have his equipment in order
- A substitute who has not completed the substitution procedure by setting foot on the pitch via his substitution zone cannot restart play by taking a kick-in, corner kick, etc. until he completes the substitution procedure
- If a player who is about to be replaced refuses to leave the pitch, the substitution cannot be made
- If a substitution is made during the half-time interval or before any of the periods of extra time, the substitute may enter the pitch via the substitution zone after informing the third referee or the referee, if there is no third referee

Extra persons on the pitch

Outside agents

Anyone not indicated on the list of players before the start of the match as a player or substitute or who is not a team official is deemed to be an outside agent.

If an outside agent enters the pitch:

- the referees must stop play (although not immediately if the outside agent does not interfere with play)
- the referees must have him removed from the pitch and its immediate surroundings

- if the referees stop the match, they must restart play with a dropped ball from the position of the ball when play was stopped, unless play was stopped inside the penalty area, in which case one of the referees drops the ball on the penalty area line at the point nearest to where the ball was located when play was stopped

Team officials

If a team official enters the pitch:

- the referees must stop play (although not immediately if the team official does not interfere with play or if the advantage can be applied)
- the referees must have him removed from the pitch and if his behaviour is irresponsible, the referees must expel him from the pitch and its immediate surroundings
- if the referees stop the match, they must restart play with a dropped ball from the position of the ball when play was stopped, unless play was stopped inside the penalty area, in which case one of the referees drops the ball on the penalty area line at the point nearest to where the ball was located when play was stopped

Players sent off

If a sent-off player enters the pitch:

- the referees must stop play, although not immediately if the sent-off player does not interfere with play or if the advantage can be applied
- the referees must have him removed from the pitch and its immediate surroundings
- if the referees stop the match, they must restart play with a dropped ball from the position of the ball when the match was stopped, unless play was stopped inside the penalty area, in which case one of the referees drops the ball on the penalty area line at the point nearest to where the ball was located when play was stopped

Player outside the pitch

If, after leaving the pitch to correct unauthorised equipment or kit, to be treated for an injury or bleeding, because he has blood on his kit or for any other reason with the referees' permission, a player re-enters the pitch without the referees' permission, the referees must:

- stop play, although not immediately if they can apply the advantage
- caution the player for entering the pitch without permission
- order the player to leave the pitch if necessary (e.g. infringement of Law 4)

If the referees stop play, it must be restarted:

- with an indirect free kick to the opposing team from the position of the ball when play was stopped (see Law 13 – Position of free kick) if there is no other infringement
- in accordance with Law 12 if the player also infringes this Law

If a player who is outside the pitch with the referees' permission and who has not been substituted re-enters the pitch without the permission of the referees or the third referee and furthermore commits another cautionable infringement, the referees send him off for a double caution, e.g. the player enters without the permission of the referees or the third referee and trips an opponent in a reckless manner. If this infringement is committed with excessive force, the player is sent off directly.

If the referees stop play, it must be restarted in accordance with Law 12.

If a player accidentally crosses one of the boundary lines of the pitch, he is not deemed to have committed an infringement. If a player leaves the pitch as part of a playing movement, he is not deemed to have committed an infringement.

Substitutes

If a substitute enters the pitch by infringing the substitution procedure or causes his team to be playing with an extra player, the referees, assisted by the assistant referees, must adhere to the following guidelines:

- Stop play, although not immediately if the advantage can be applied
- Caution him for unsporting behaviour if his team plays with an extra player or for infringing the substitution procedure if the substitution was not made correctly
- Send him off if he denies the opposing team a goal or an obvious goalscoring opportunity. The number of players in his team is reduced irrespective of whether the offence consists of an infringement of the substitution procedure or because his team is playing with an extra player, in which case in addition to the substitute sent off, another of the players must leave the pitch so that his team is then playing with one player less, with a new player being introduced as specified in the section of Law 3 entitled "Players and substitutes sent off"

- The substitute must leave the pitch at the first stoppage in the match if he has not left before, either to complete the substitution procedure, if the infringement was for this reason, or to move to the technical area, if his team was playing with an extra player
- If they apply the advantage, they stop play once the substitute's team is in possession of the ball and restart it with an indirect free kick for the opposing team from the position of the ball when play was stopped (see Law 13 – Position of free kick)
- If they apply the advantage and stop play because the opposing team commits an infringement or because the ball leaves the pitch, they must restart play with an indirect free kick to the opponents of the substitute's team from the position of the ball when play was stopped (see Law 13 – Position of free kick). If necessary, they also take the disciplinary action corresponding to the infringement committed by the opponents of the substitute's team
- If they apply the advantage and another player of the substitute's team commits an infringement punishable by a direct free kick or penalty kick, they sanction the substitute's team with a direct free kick (see Law 13 – Position of free kick) or penalty kick. If necessary, they also take the disciplinary action corresponding to the infringement committed
- If they apply the advantage and the substitute does not follow the substitution procedure and commits an infringement punishable by a direct free kick or penalty kick, they sanction the substitute's team with a direct free kick (see Law 13 – Position of free kick) or penalty kick. If necessary, they also take the disciplinary action corresponding to the infringement committed
- If they apply the advantage and the substitute's team plays with an extra player, and this player commits an infringement punishable by a direct free kick or penalty kick, they sanction this player's team with an indirect free kick from the position of the ball when play was stopped (see Law 13 – Position of free kick). If necessary, they also take the disciplinary action corresponding to the infringement committed

If a named substitute enters the pitch instead of a named player at the start of the match and the referee or assistant referees are not informed of this change:

- the referees allow the named substitute to continue the match
- no disciplinary sanction is taken against the named substitute
- the referee reports the incident to the appropriate authorities

If a substitute commits a sending-off offence before entering the pitch, the number of players in his team is not reduced and another substitute or the player he was going to replace may enter the pitch.

Authorised departure from the pitch

In addition to a normal substitution, a player may leave the pitch without the referees' permission in the following situations:

- As part of a playing movement whereby he immediately returns to the pitch, i.e. to play the ball or place himself in an advantageous position by dribbling past an opponent. However, it is not permitted to leave the pitch and pass behind one of the goals before re-entering the pitch with the aim of deceiving the opponents; if he does, the referees stop play if they cannot apply the advantage. If they stop play, they must restart it with an indirect free kick from the position of the ball when play was stopped (see Law 13 – Position of free kick). The player is cautioned for leaving the pitch without the referees' permission
- Due to injury. The player needs the permission of the referees or the third referee to re-enter the pitch if he has not been substituted. If he is suffering from a bleeding wound, the bleeding must have stopped before he re-enters the pitch and he must be checked by the referees or the third referee
- To correct or put back on his equipment. The player needs the referees' permission to re-enter the pitch if he has not been substituted, and the referees or the third referee must check his equipment before he returns to the match

Unauthorised departure from the pitch

If a player leaves the pitch without the referees' permission and for reasons not permitted in the Futsal Laws of the Game, the timekeeper or the third referee sounds the acoustic signal to inform the referees if the advantage cannot be applied. If it is necessary to stop play, the referees sanction the offending player's team with an indirect free kick from the position of the ball when the infringement was committed (see Law 13 – Position of free kick). If the advantage is applied, they must sound the acoustic signal at the next stoppage in play. The player is cautioned for deliberately leaving the pitch without the referees' permission.

Minimum number of players

Although a match may not start if either team consists of fewer than three players, the minimum number of players, including players and substitutes, required for a match is left to the discretion of member associations.

A match may not continue if there are fewer than three players in either of the teams.

If a team has fewer than three players because one or more players has deliberately left the pitch, the referees are not obliged to stop the match immediately and the advantage may be applied. In such cases, the referees must not restart the match after play has been stopped if a team does not have the minimum number of three players.

Injured players

If there are injured players, the referees must adhere to the following guidelines:

- Allow the match to continue until the ball goes out of play if a player is, in the opinion of the referees, only slightly injured
- Play is stopped if, in the opinion of the referees, a player is seriously injured
- After questioning the injured player, the referees may authorise one, or at most two doctors, to enter the pitch to assess the injury and arrange the player's safe and swift removal from the pitch
- Stretcher-bearers should only enter the pitch with a stretcher following a signal from the referee at the same time as the doctors in order to hasten the player's removal from the pitch
- The referees must ensure that the injured player is carried off the pitch safely and swiftly
- A player is not allowed to receive treatment on the pitch, unless the seriousness of the injury requires it
- Any player bleeding from a wound must leave the pitch and may not return until the referees are satisfied that the bleeding has stopped (the third referee may check this, but the referees must authorise his entry, if he has not been substituted). A player is not allowed to wear clothing with blood on it
- As soon as the referees have authorised the doctors to enter the pitch, the player must leave the pitch, either on a stretcher or on foot. If a player does not comply, he must be cautioned for delaying the restart of play. Play is not restarted until said player has left the pitch
- An injured player may leave the pitch from a place other than the substitution zone. He may do so from any line that marks the pitch boundaries
- An injured player may be substituted, but the substitute must enter via the substitution zone once the injured player has left the pitch
- If he has not been substituted, a player who was injured may return to the pitch only after the match has restarted
- If he has not been substituted, an injured player may re-enter the pitch when the ball is in play, but only from the touch line. When the ball is out of play, he may enter the pitch from any boundary line (goal line and touch line)

- Only the referees may allow an injured player who has not been substituted to return to the pitch, whether the ball is in play or not. He is not permitted to enter if the ball is in play and if play is developing through the area in which he is located
- The referees may give permission for an injured player to return to the pitch if the third referee verifies that the player is ready
- If play has not otherwise been stopped for another reason, or if an injury suffered by a player is not the result of an infringement of the Futsal Laws of the Game, the referees must stop play and restart it with a dropped ball from the position of the ball when play was stopped, unless play was stopped inside the penalty area, in which case one of the referees drops the ball on the penalty area line at the point nearest to where the ball was located when play was stopped
- Once the referees have decided to issue a card to a player who is injured and has to leave the pitch for treatment, the referees must issue the card before the player leaves the pitch
- They do not issue a card to an injured player when he is receiving treatment, but once he has returned and before play has been restarted. If the player has to leave the pitch on a stretcher, they issue the card before he leaves the pitch
- The third referee assists the referees with the enforcement of permissions to enter the pitch granted to substitutes replacing injured players or players who were injured

Exceptions to this ruling are to be made only when:

- a goalkeeper is injured
- a goalkeeper and any other player have collided and need immediate attention
- players from the same team have collided and need immediate attention
- a serious injury has occurred, e.g. swallowed tongue, concussion, broken leg, broken arm, etc.

Refreshments

The referees allow players to take refreshments during time-outs or during a stoppage in the match, but only outside the pitch, so that it does not become wet. It is not permitted to throw bags containing liquids or any other receptacle containing liquid on to the pitch.

Players sent off

- If a player who commits an infringement is sent off for a second caution or directly after the advantage has been applied and his team concedes a goal after the application of the advantage before he is sent off, the number of players in his team is not reduced, as the infringement was committed before the goal was scored
- If, during the interval or before the start of one of the periods of extra time, a player commits a sending-off offence, his team starts the next half or period of extra time with one player fewer

Basic equipment

Colours:

- If the jerseys of the two goalkeepers are the same colour and neither has another jersey to change into, the referee allows play to begin

If a player loses his footwear accidentally and immediately plays the ball and scores a goal, there is no infringement and the goal is awarded because he lost his footwear by accident.

Other equipment

A player may use equipment other than the basic equipment, provided that its sole purpose is to protect him physically and it poses no danger to him or any other player.

All items of clothing or equipment must be inspected by the referees and determined not to be dangerous.

Modern protective equipment, such as headgear, facemasks and knee and arm protectors made of soft, lightweight padded material are not considered dangerous and are therefore permitted.

Where head covers are worn, they must:

- be black or of the same colour as the main colour of the jersey (provided that the players of the same team wear the same colour)
- be in keeping with the professional appearance of the player's equipment
- not be attached to the jersey
- not pose any danger to the player wearing it or any other player (e.g. opening/closing mechanism around neck)
- not have any part(s) extending out from the surface (protruding elements)

Sports spectacles are permitted if they pose no danger to the players.

If an item of clothing or equipment that has been inspected at the start of a match and determined not to be dangerous becomes dangerous or is used in a dangerous manner during the match, its use must no longer be allowed.

The use of electronic communication systems between players and/or technical staff is not permitted.

Jewellery

All items of jewellery (necklaces, rings, bracelets, earrings, leather bands, rubber bands, etc.) are strictly forbidden and must be removed by the players and substitutes before the start of the match. Using tape to cover jewellery is not acceptable.

Referees and assistant referees are also prohibited from wearing jewellery (except for the referee, who is permitted to wear a watch or similar device to time the match if the timekeeper is absent).

Numbering of the players

The competition rules must stipulate the numbering of the players, which is normally from 1 to 15, with number 1 reserved for a goalkeeper.

The organisers must bear in mind that it is impossible for referees to signal numbers greater than 15.

The number of each player must be visible on his back and be distinguishable from the main colour of the shirt. The competition rules must determine the size of the numbers and whether they are mandatory, as well as their size on other items of the players' basic equipment.

Disciplinary sanctions

Before the match begins, players and substitutes must be checked to ensure that they are not wearing any unauthorised clothing or jewellery. The third referee makes a second visual check of the substitutes before they enter the pitch. If a player is discovered to be wearing unauthorised clothing or jewellery during play, the referees must:

- inform the player that the item in question must be removed
- order the player to leave the pitch at the next stoppage if he is unable or unwilling to comply
- caution the player if he wilfully refuses to comply or, having been told to remove the item, is discovered to be wearing the item again

If play is stopped to caution the player, an indirect free kick must be awarded to the opposing team from the position of the ball when play was stopped (see Law 13 – Position of free kick).

Powers and duties

Futsal is a competitive sport, and referees must understand that physical contact between the players is normal and an acceptable part of the game. Nevertheless, if the players do not respect the Futsal Laws of the Game and the principles of sportsmanship, i.e. fair play, the referees must take the appropriate action to ensure that they are respected.

The referees must suspend the match if, in their opinion, the lighting is inadequate due to a failure of some kind. If the failure cannot be repaired, the referee abandons the match.

If an object thrown by a spectator hits a match official, a player or a team official, the referee may allow the match to continue, suspend play or abandon the match, depending on the severity of the incident. He must, in all cases, report the incident(s) to the appropriate authorities.

The referees have the power to caution or send off players during the half-time interval and after the match has finished as well as during extra time and kicks from the penalty mark, since disciplinary decisions remain under their jurisdiction at these times.

If one of the referees is temporarily incapacitated for any reason, play may continue under the supervision of the other referee and the assistant referees until the ball next goes out of play.

Advantage

The referees may play advantage whenever an infringement or offence occurs and the Futsal Laws of the Game do not explicitly prohibit the advantage from being applied. For example, it is permitted at a goal clearance with attacking players inside the penalty area if the goalkeeper wishes to take the clearance quickly; however, it is not permitted when a kick-in is taken incorrectly.

The advantage is not permitted for infringements of the four-second rule, unless the infringement is committed by the goalkeeper in controlling the ball when it is already in play in his own half of the pitch, and if he loses possession of the ball. In the remaining cases: free kicks, kick-ins, goal clearances and corner kicks, the referees cannot apply the advantage.

The referees should consider the following circumstances in deciding whether to apply the advantage or stop play:

- The severity of the offence: if the infringement warrants an expulsion, the referees must stop play and send off the player unless there is an opportunity to score a goal
- The position where the offence was committed: the closer to the opposing goal, the more effective it can be
- The chances of an immediate, promising attack
- The infringement committed must not be a team's sixth or greater accumulated foul, unless there is an opportunity to score a goal
- The atmosphere of the match

The decision to penalise the original offence must be taken within a few seconds, but it is not possible to go back if the corresponding signal has not previously been given or a new passage of play has been allowed.

If the offence warrants a caution, it must be issued at the next stoppage. However, unless there is a clear advantage, it is recommended that the referees stop play and caution the player immediately. If the caution is not issued at the next stoppage, it cannot be shown later.

If an infringement requires play to be restarted with an indirect free kick, the referees must apply the advantage to ensure that play flows, provided that this does not lead to any retaliation and is not prejudicial to the team against which the offence was committed.

More than one offence occurring at the same time

- Offences committed by two or more players from the same team:
 - The referees must punish the most serious offence
 - Play must be restarted according to the most serious offence committed
 - Notwithstanding the above two paragraphs, the referees caution or send off the players in accordance with the infringements committed or do not take any disciplinary action
 - If the offences committed are punishable by a direct free kick, the referees order the corresponding accumulated fouls to be recorded
- Offences committed by players from different teams:
 - The referees stop the match, as they cannot apply the advantage, and restart play with a dropped ball from the position of the ball when play was stopped, unless play was stopped inside the penalty area, in which case one of the referees drops the ball on the penalty area line at the point nearest to where the ball was located when play was stopped
 - Notwithstanding the above paragraph, the referees caution or send off the players in accordance with the infringements committed or do not take any disciplinary action
 - If the offences committed are punishable by a direct free kick, the referees order the corresponding accumulated fouls to be recorded

External interference

The referees stop play if a spectator blows a whistle and they consider that this action interferes with play, e.g. if a player picks up the ball with his hands. If play is stopped, it must be restarted with a dropped ball from the position of the ball when play was stopped, unless play was stopped inside the penalty area, in which case one of the referees drops the ball on the penalty area line at the point nearest to where the ball was located when play was stopped.

Four-second count when the ball is in play

Each time that a team's goalkeeper is in possession of the ball while it is in play and in his own half of the pitch, one of the referees must visibly perform the four-second count.

Restart of play

The referees especially ensure that restarts of play are carried out quickly and do not allow play not to be restarted immediately for tactical reasons after a stoppage (kick-in, goal clearance, corner kick or free kick). In these cases, the four-second count starts and it is not necessary to use the whistle. In cases where the restart does not allow the four-second count (kick-off or penalty kick), the player or players who delay it are cautioned.

Persons holding balls are permitted to position themselves around the pitch to facilitate restarts and the development of play.

Positioning with ball in play

Recommendations

- The play should be between the referee and the second referee
- The referees should use a wide diagonal system
- Staying outside and parallel to the touch line makes it easier to keep the play and the other referee within the referee's field of vision
- The referee nearest to the play should be within the other referee's field of vision
- One of the referees should be close enough to see play without interfering with it
- The referees only enter the pitch to obtain a better view of the play
- "What needs to be seen" is not always in the vicinity of the ball. The referees should also pay attention to:
 - aggressive individual player confrontations off the ball
 - possible offences in the penalty area towards which play is heading
 - offences occurring after the ball is played away

General positioning during the match

One of the referees must be in line with the second-last member of the defending team or the ball if it is nearer the goal line than the second-last member of the defending team. The referees must always face the pitch.

Goalkeeper releasing the ball

One of the referees must take a position in line with the edge of the penalty area and check that the goalkeeper does not touch the ball with his hands outside the penalty area, while also timing the number of seconds he is in possession of the ball.

Once the goalkeeper has released the ball, the referee must take a suitable position for controlling the match.

“Goal – no goal” situations

When a goal has been scored and there is no doubt about the decision, the referee and the second referee must make eye contact and the referee nearest to the timekeeper’s table must approach the timekeeper and the third referee to communicate the number of the player who scored the goal with the mandatory signal.

If a goal has been scored but the ball appears to still be in play, the referee who is nearest blows his whistle to attract the attention of the other referee and then the referee nearest to the timekeeper’s table approaches the timekeeper and the third referee to communicate the number of the player who scored the goal with the mandatory signal.

Positioning in ball out of play situations

The best position is one from which the referee can make the right decision. All recommendations about positioning are based on probabilities and must be adjusted using specific information about the teams, the players and events in the match up to that point.

The positions suggested in the following graphics are basic; some are recommended to referees and others are mandatory. The reference to a “zone” is intended to emphasise that every recommended position is actually an area within which the referee is most likely to optimise his effectiveness. The zone may be larger, smaller or differently shaped depending on circumstances.

1. Positioning – kick-off (mandatory)

At the start of the match, the referee situated on the touch line where the substitution zones are located must be in line with the halfway line to check that the kick-off is taken in accordance with the established procedure. The second referee must be in line with the second-last defender of the team that is not taking the kick-off.

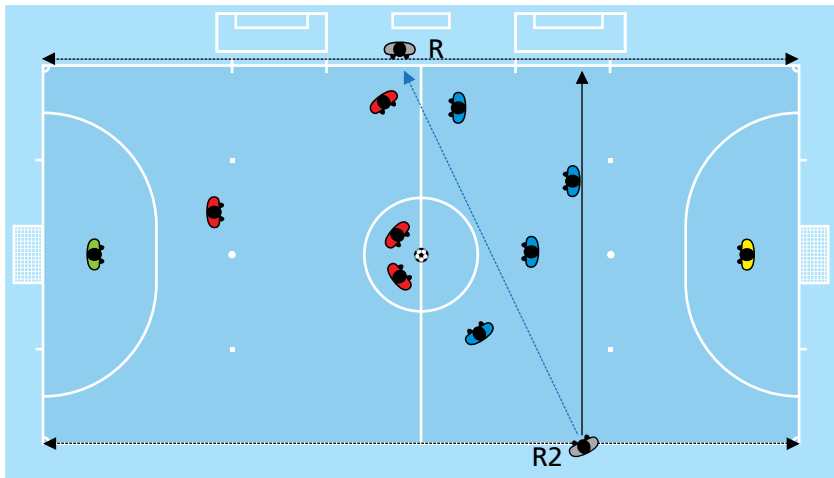

2. Positioning – goal clearance

1. One of the referees must check first if the ball is inside the penalty area:
 - If the ball is not placed correctly, the referee may start the four-second count if he considers that the goalkeeper was ready to take the goal clearance or is delaying picking the ball up in his hands for tactical reasons
2. Once the ball is inside the penalty area, one of the referees must take a position in line with the edge of the penalty area to check that the ball leaves the penalty area (ball in play) and that the members of the opposing team are outside. He then performs the four-second count, irrespective of whether he has started it in accordance with the previous point.
3. Finally, the referee who supervised the goal clearance must take a suitable position for controlling the match, which is a priority in any case.

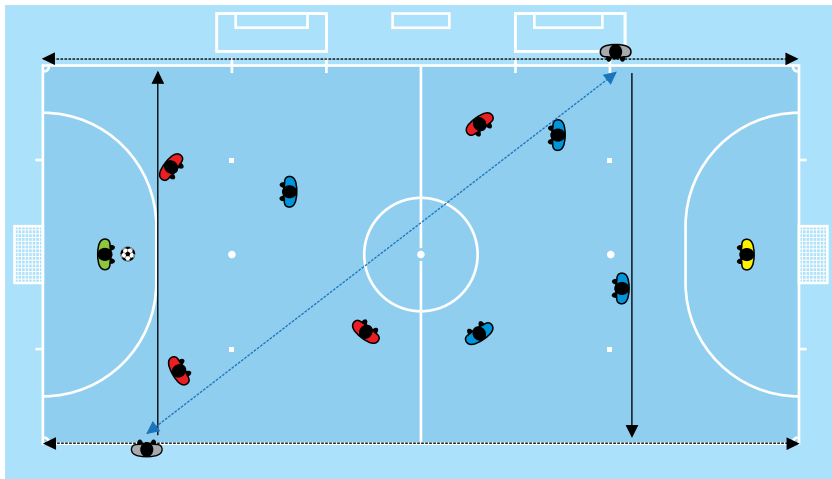

3. Positioning – corner kick (mandatory) [1]

During a corner kick, the referee nearest to the place where it is to be taken takes a position on the touch line at a distance of approximately 5m from the corner arc. From this position he must check that the ball is properly placed inside the corner arc and that the defenders have retreated 5m. The referee furthest from the place where the corner kick is to be taken takes a position behind the corner arc in line with the goal line. From this position he watches the ball and the behaviour of the players.

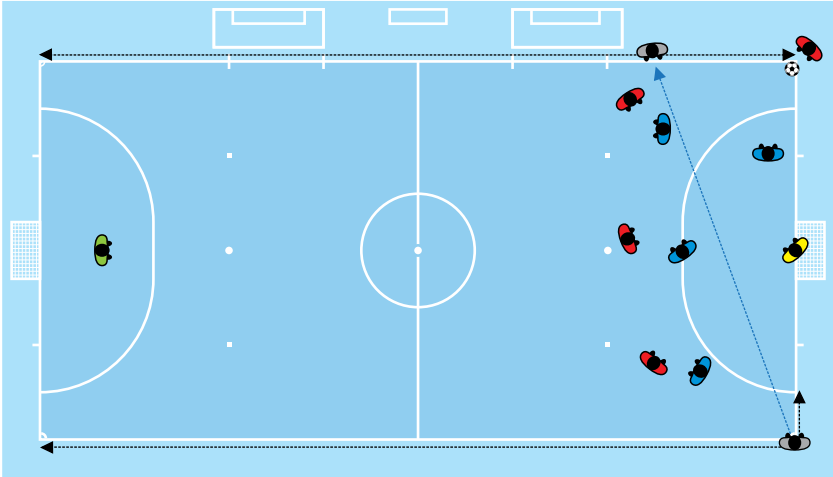

4. Positioning – corner kick (mandatory) [2]

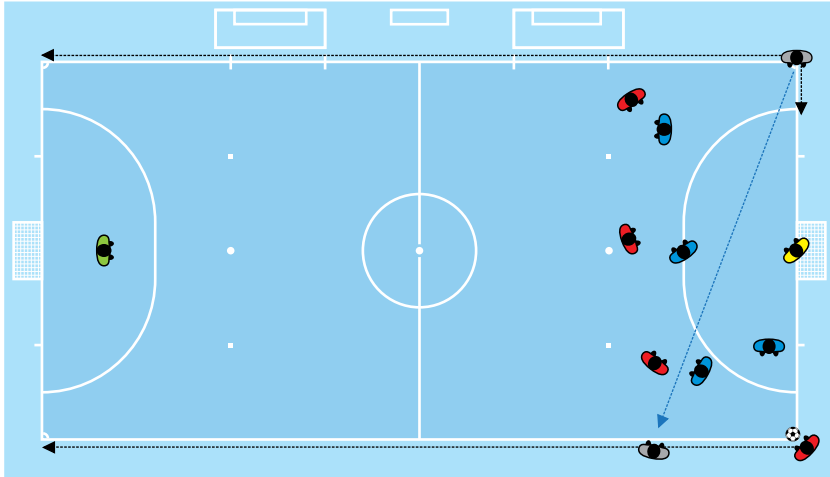

5. Positioning – free kick [1]

During a free kick, the referee who is nearest takes a position in line with the place from where the kick is to be taken and checks that the ball is properly placed, as well as watching the players for encroachment while the kick is being taken. The referee furthest from the place from where the kick is to be taken must take a position in line with the second-last opponent or the goal line, which is a priority in any case. Both referees must be ready to follow the trajectory of the ball and run along the touch line towards the corner arc if a direct free kick is taken towards the goal and they are not in line with the goal line.

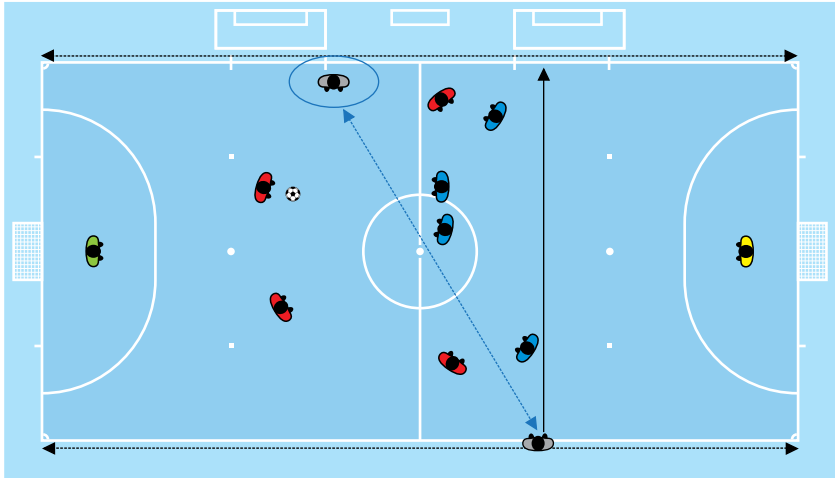

6. Positioning – free kick [2]

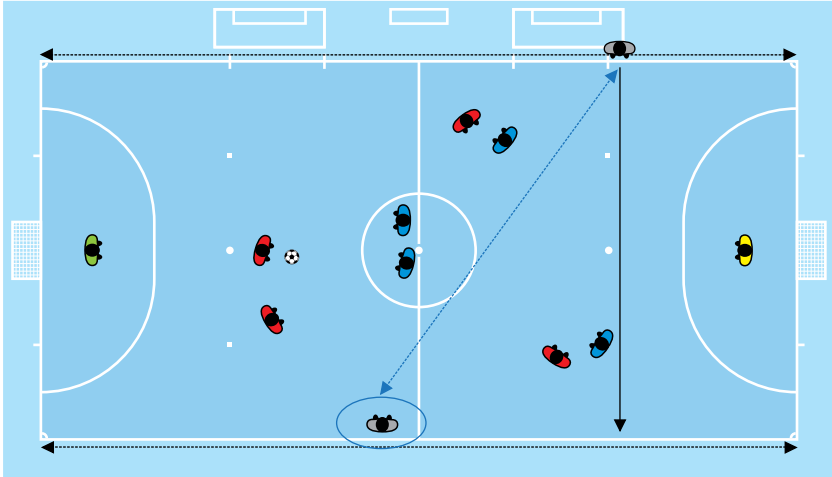

7. Positioning – free kick [3]

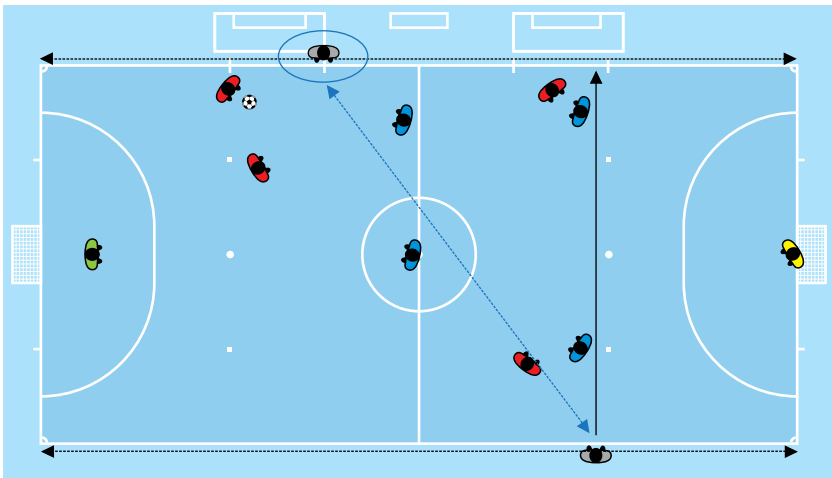

8. Positioning – free kick [4]

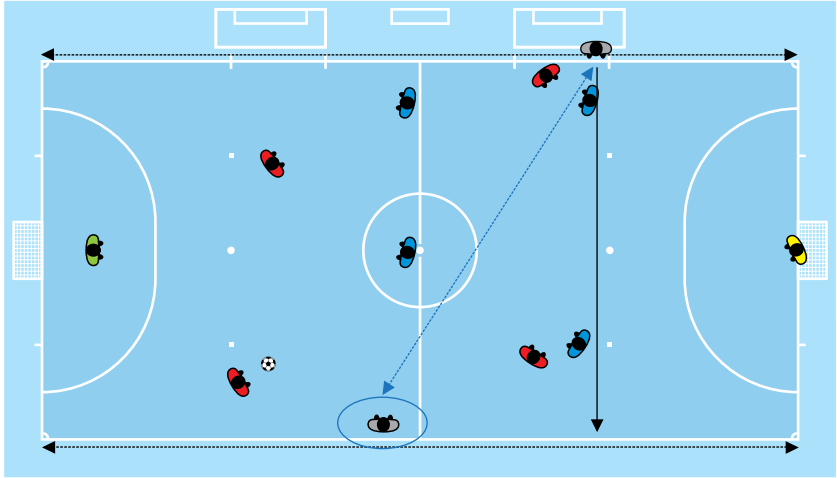

9. Positioning – penalty kick (mandatory)

One of the referees is positioned in line with the penalty mark at an approximate distance of 5m and checks that the ball is properly placed, identifies the kicker and watches the players for encroachment while the kick is being taken. He does not order the kick to be taken until he has checked that the position of all the players is correct and is assisted by the other referee if necessary. The other referee must be positioned at the intersection of the goal line and the penalty area. If the goalkeeper advances from the goal line before the kick has been taken and a goal is not scored, the referee blows his whistle to order the penalty kick to be retaken.

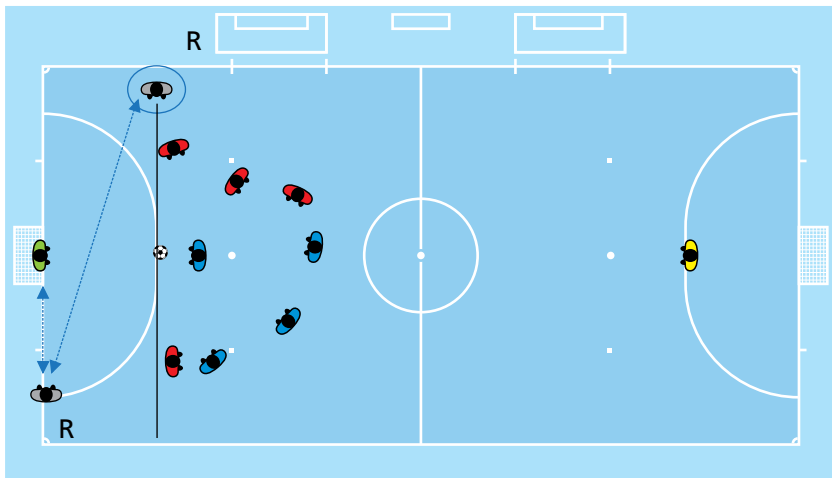

10. Positioning – kicks from the second penalty mark (mandatory)

One of the referees is positioned in line with the second penalty mark at an approximate distance of 5m and checks that the ball is properly placed, identifies the kicker and watches the players for encroachment while the kick is being taken. He does not order the kick to be taken until he has checked that the position of all the players is correct and is assisted by the other referee if necessary. The other referee must be positioned at the intersection of the goal line and the penalty area and checks whether the ball enters the goal.

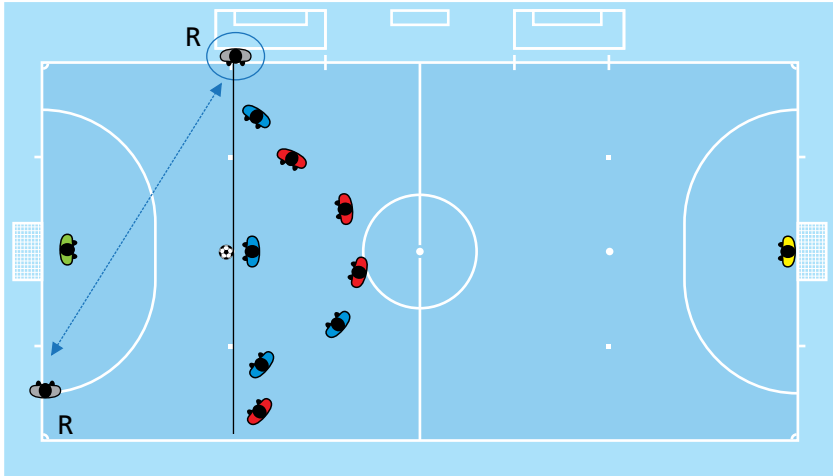

11. Positioning – free kicks beginning with the sixth accumulated foul (mandatory) [1]

One of the referees is positioned in line with the position of the ball at an approximate distance of 5m, if possible, checks that the ball is properly placed, identifies the kicker and watches the players for encroachment while the kick is being taken. He does not order the kick to be taken until he has checked that the position of all the players is correct and is assisted by the other referee. The other referee must be positioned at the intersection of the goal line and the penalty area and checks whether the ball enters the goal.

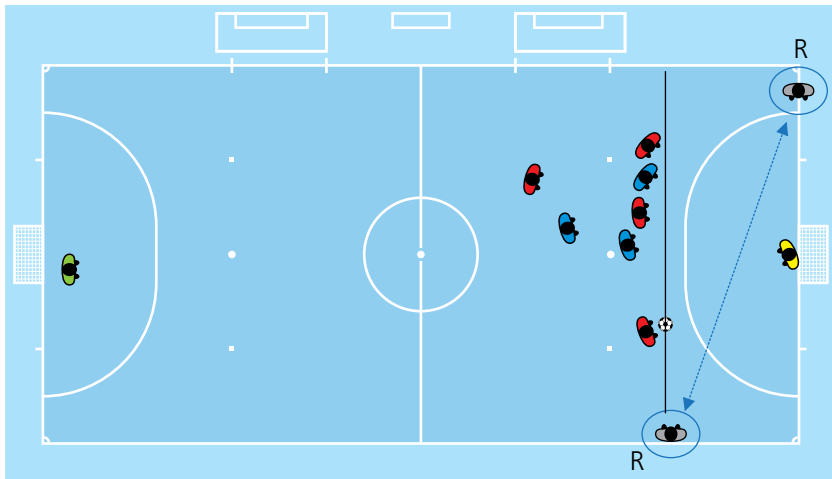

12. Positioning – free kicks beginning with the sixth accumulated foul (mandatory) [2]

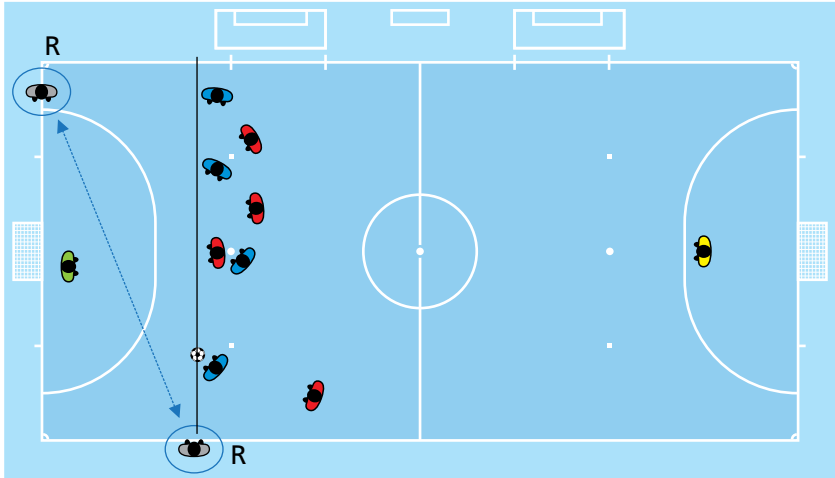

13. Positioning – kick-in [1]

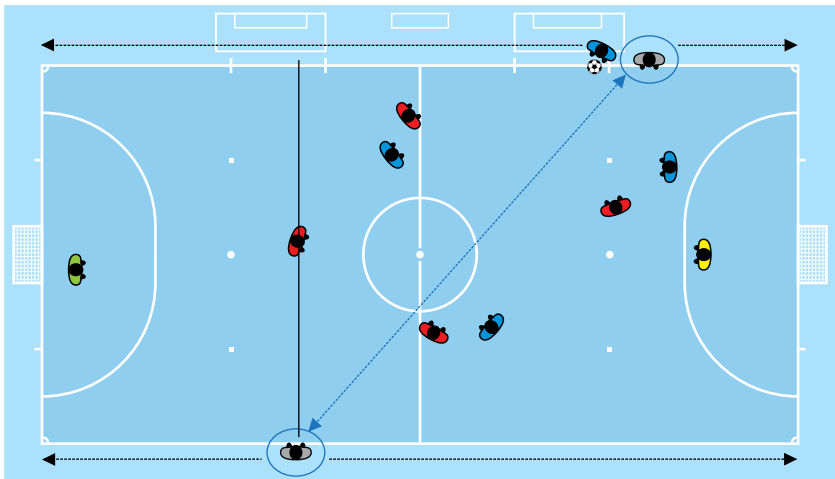

14. Positioning – kick-in [2]

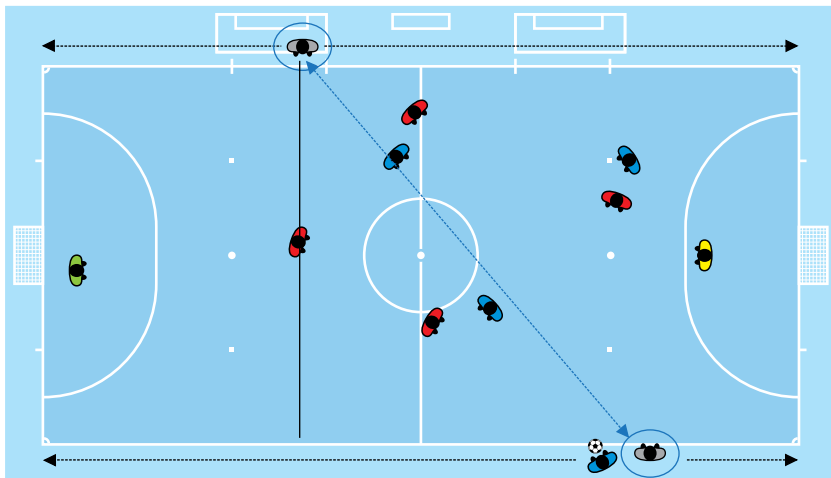

15. Positioning – kick-in [3]

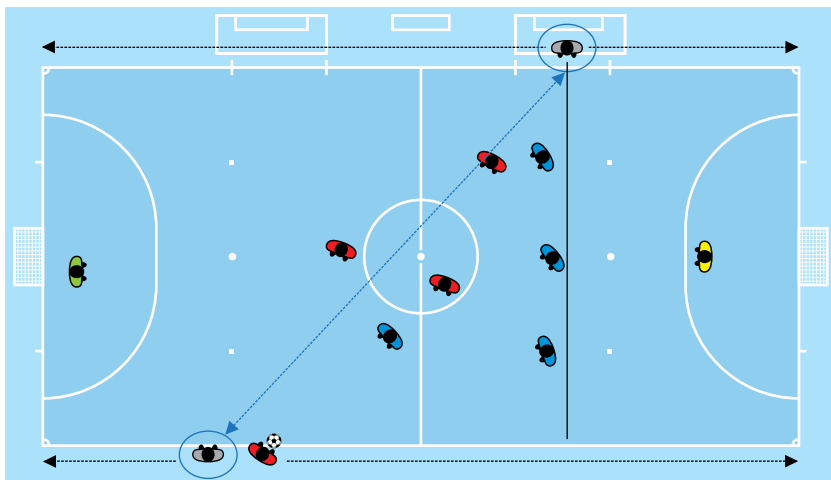

16. Positioning – kick-in [4]

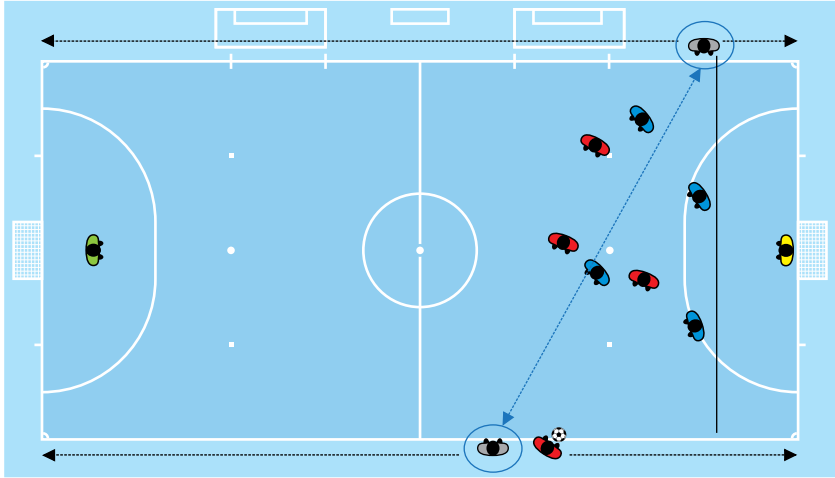

17. Positioning – kick-in (mandatory) [5]

During a kick-in close to the corner arc in favour of the attacking team, the referee nearest to the place from where it is to be taken remains at an approximate distance of 5m. From this position he checks that the kick-in is taken in accordance with the procedure and that the defenders have retreated 5m from the touch line. The referee furthest from the place where the kick-in is to be taken takes a position behind the corner arc in line with the goal line. From this position he watches the ball and the behaviour of the players.

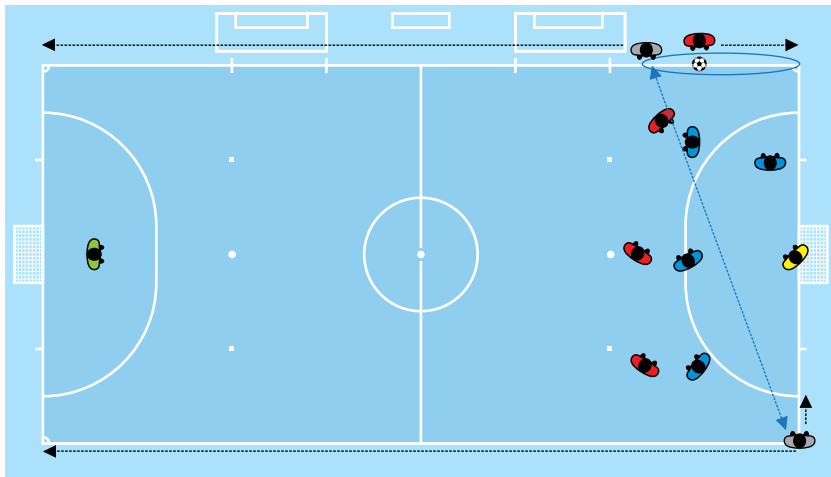

18. Positioning – kicks from the penalty mark to determine the winner of a match or home-and-away (mandatory)

The referee must be positioned on the goal line approximately 2m from the goal. His main duty is to check if the ball crosses the line and whether the goalkeeper advances from the line:

- When it is clear that the ball has crossed the goal line, the referee must make eye contact with the second referee to check that no infringement has been committed

The second referee must be situated in line with the penalty mark at an approximate distance of 3m to check that the ball and the goalkeeper of the team of the kicker are correctly positioned.

The third referee must be situated in the centre circle to control the remaining players of both teams.

The timekeeper must be positioned at the timekeeper's table and checks that the players excluded from taking the penalty kicks and the team officials behave correctly.

All the referees make a note of the penalty kicks taken and the numbers of the players who took them.

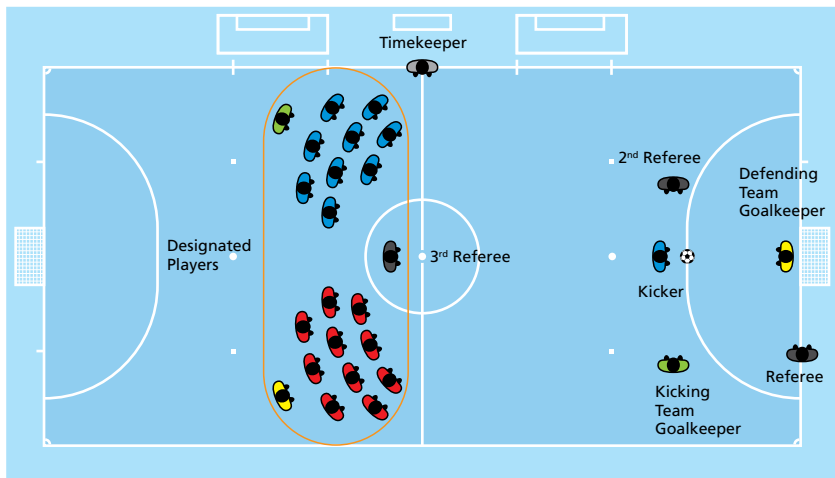

Use of whistle

The use of the whistle is mandatory for:

- kick-offs:
 - to start play (1st and 2nd half and 1st and 2nd half of extra time, if necessary)
 - to restart play after a goal
- stopping play:
 - to award a free kick or penalty kick
 - to suspend or abandon a match or to confirm the timekeeper's acoustic signal when he ends the period of play, or on completion of the trajectory of the ball if it is heading towards one of the goals once the period has ended
- restarting play for:
 - free kicks to ensure that the defending players observe the required distance
 - kicks from the second penalty mark
 - free kicks without a wall beginning with the sixth accumulated foul
 - penalty kicks
- restarting play after it has been stopped due to:
 - the issue of a caution or sending-off for misconduct
 - injury to one or more players

The use of the whistle is not needed to:

- stop play for:
 - a goal clearance, corner kick or kick-in (it is mandatory if the situation is unclear)
 - a goal (it is mandatory if the ball has not clearly entered the goal)
- restart play from:
 - a free kick if the distance of 5m has not been requested or the opposing team to the kicker has not committed six accumulated fouls or for a goal clearance, corner kick or kick-in

The whistle may not be used to:

- restart play with a dropped ball

A whistle which is used too frequently will have less impact when it is needed. When the team taking a free kick, kick-in or corner kick requests that the defending players observe the required distance or the correct positioning of the opposing players during a goal clearance, the referees will clearly inform the players that play cannot be restarted until after the whistle. If in these cases the player restarts play before the referees' whistle, the player is cautioned for delaying the restart of play.

If during play one of the referees sounds his whistle by mistake, the referees must stop the match if they consider this action to interfere with play. If the referees stop the match, they must restart play with a dropped ball from the position of the ball when play was stopped, unless play was stopped inside the penalty area, in which case one of the referees drops the ball on the penalty area line at the point nearest to where the ball was located when play was stopped. If the sound of the whistle does not interfere with play, the referees give clear signals to play on.

Body language

Body language is a tool that the referees use to:

- help themselves control the match
- show authority and self-control

Body language is not:

- a means of justifying a decision

Duties and responsibilities

The third referee and the timekeeper help the referees to control the match in accordance with the Futsal Laws of the Game. They also assist the referees in all other matters involving the running of the match at the request and under the direction of the referees. This commonly includes such matters as:

- inspecting the pitch, the balls used and players' equipment
- determining if problems with equipment or bleeding have been resolved
- monitoring the substitution procedure
- maintaining back-up records of time, goals, accumulated fouls and misconduct

Positioning of the assistant referees and teamwork

1. Kick-off

The third referee is situated at the timekeeper's table and checks that the substitutes, officials and other persons are correctly positioned.

The timekeeper is situated at the timekeeper's table and checks that the kick-off is taken correctly.

2. General positioning during the match

The third referee checks that substitutes, officials and other persons are in the correct position. To do so he may move along the touch line, if necessary, but without entering the pitch.

The timekeeper is positioned at the timekeeper's table and ensures that the chronometer is stopped and started in accordance with the development of play.

3. Substitutions

The third referee checks that the substitutes' equipment is correct and that the substitutions are made correctly. To do so he may move along the touch line, if necessary, but without entering the pitch.

4. Kicks from the penalty mark

The third referee must be positioned in the half of the pitch where the penalty kicks are not being taken, together with the eligible players. From this position he observes the players' behaviour and checks that no player takes another penalty kick before all of the other eligible players in his team have done so.

The timekeeper is positioned at the timekeeper's table and records all the goals scored.

Assistant referee signals (mandatory)

The assistant referees must give the signals for a team's fifth accumulated foul and a request for a time-out, indicating with their arms the bench of the team that has committed its fifth accumulated foul or requested the time-out.

Acoustic signal

The acoustic signal is an essential signal in a match to be used only when necessary in order to gain the attention of the referee.

Situations when the acoustic signal is mandatory:

- End of the periods of play
- Notice of a request for a time-out
- Notice of the end of a time-out
- Communication of the fifth accumulated foul by a team
- Notice of incorrect behaviour by substitutes or team officials
- Notice of a breach of the substitution procedure
- Notice of a disciplinary error committed by the referees
- Notice of external interference

If during the match the timekeeper sounds the acoustic signal by mistake, the referees must stop the match if they consider this action to interfere with play. If the referees stop the match, they must restart play with a dropped ball from the position of the ball when play was stopped, unless play was stopped inside the penalty area, in which case one of the referees drops the ball on the penalty area line at the point nearest to where the ball was located when play was stopped. If the sound of the acoustic signal does not interfere with play, the referees give clear signals to play on.

If a team that has committed four accumulated fouls commits another one and the referees decide to apply the advantage, the third referee places the signal for the fifth accumulated foul in the correct place on the timekeeper's table. However, if that team commits a new accumulated foul before the ball is out of play, the assistant referees must sound the acoustic signal, unless the opposing team to the one that committed the foul has an obvious goalscoring opportunity.

Chronometer

If the chronometer does not work properly, the assistant referees inform the referees of this fact. The timekeeper must continue timing the match using a manual chronometer. In such a situation, they invite an official from each team in order to inform them of the real match time.

If, after a stoppage in play, the timekeeper forgets to start the chronometer, the referees order the time that was not counted to be added on.

After restarts, the chronometer is started as follows:

- Kick-off: after the ball is kicked towards the opponents' half of the pitch, in accordance with the procedure
- Goal clearance: after the goalkeeper releases the ball from his hands and the ball leaves the penalty area, in accordance with the procedure
- Corner kick: after the ball is kicked and moves, in accordance with the procedure
- Kick-in: after the ball enters the pitch after being kicked, in accordance with the procedure
- Direct free kick outside the penalty areas: after the ball is kicked, in accordance with the procedure
- Indirect free kick outside the penalty areas to either of the teams or taken by the attacking team from the penalty area line: after the ball is kicked, in accordance with the procedure
- Direct or indirect free kick inside the penalty areas to the defending team: after the ball is kicked and leaves the penalty area, in accordance with the procedure

- Penalty kick: after the ball is kicked forward, in accordance with the procedure
- Direct free kick after the fifth accumulated foul: after the ball is kicked with the intention of scoring a goal, in accordance with the procedure
- Dropped ball: after the ball is released from the hands of one of the referees and touches the pitch, in accordance with the procedure



Time-out



Fifth accumulated foul

Half-time interval

The referees allow an interval between the two halves if a player of one of the teams requests one, even if the captains of both teams have asked not to have an interval.

Extra time

If extra time is played, there is no interval between the two periods. The teams simply change halves of the pitch and the substitutes and team officials change technical areas.

Kick-off

- The referees do not have to request the confirmation of the goalkeepers or any other player before ordering the kick-off to be taken

Dropped ball

- Any player may challenge for the ball (including the goalkeeper)
- There is no minimum or maximum number of players for contesting a dropped ball
- The referees cannot decide who may or may not contest a dropped ball
- There is no required distance to be respected by the players, unless the opponent is blocked and the dropped ball cannot be taken
- It is not necessary for a team to contest a dropped ball
- If an infringement is committed by a player before the ball is in play but after one of the referees has released it from his hands, the referee retakes the dropped ball after taking the corresponding disciplinary action

The ball inside the pitch touches one of the referees

If, when the ball is in play, it touches one of the referees who is temporarily on the pitch, play continues because the referees are part of the match.

If, when the ball is in play, it touches one of the assistant referees who is temporarily on the pitch, the referees stop play and restart it with a dropped ball from the position of the ball when play was stopped, unless play was stopped inside the penalty area, in which case one of the referees drops the ball on the penalty area line at the point nearest to where the ball was located when play was stopped.

Goal scored while a person not participating in the match is on the pitch

If, after a goal is scored, the referees realise, before play restarts, that another person was on the pitch at the time that the goal was scored:

- they must disallow the goal if:
 - the other person was an outside agent or official from one of the teams and interfered with play
 - the other person was a player, substitute, sent-off player or official of the team that scored the goal
- they must allow the goal if:
 - the other person was an outside agent and did not interfere with play
 - the other person was a player, substitute, sent-off player or official of the team that conceded the goal

No goal

If one of the referees signals a goal before the ball has passed wholly over the goal line and immediately realises his error, play is restarted with a dropped ball on the penalty area line at the point nearest to where the ball was located when play was stopped.

There is no offside in futsal.

Basic requirements for a foul

The following conditions must be met for an offence to be considered a foul:

- It must be committed by a player or a substitute who has not correctly followed the substitution procedure
- It must occur on the pitch
- It must occur while the ball is in play

If the referees stop play due to an offence committed outside the pitch (while the ball is in play) and it has not been committed by a player who left the pitch without the referees' permission in order to do so, play must be restarted with a dropped ball from the position of the ball when play was stopped, unless play was stopped inside the penalty area, in which case one of the referees must drop the ball on the penalty area line at the point nearest to where the ball was located when play was stopped.

It is not a foul when two or more players challenge for the ball at the same time with an opponent, if the challenge is legal.

Careless, reckless, using excessive force

“Careless” means that the player has shown a lack of attention or consideration when making a challenge or that he acted without precaution:

- No further disciplinary sanction is needed if a foul is judged to be careless

“Reckless” means that the player has acted with complete disregard for the danger to, or consequences for, his opponent:

- A player who plays in a reckless manner must be cautioned

“Using excessive force” means that the player has far exceeded the necessary use of force and is in danger of injuring his opponent:

- A player who uses excessive force must be sent off

Charging an opponent

The act of charging is a challenge for space using physical contact within playing distance of the ball without using arms or elbows.

It is an offence to charge an opponent:

- in a careless manner
- in a reckless manner
- using excessive force

Holding an opponent

Holding an opponent includes the act of preventing him from moving past or around using the hands, the arms or the body.

Referees must make an early intervention and deal firmly with holding offences, especially inside the penalty area and when corner kicks, kick-ins or free kicks are being taken.

To deal with these situations, the referees must:

- warn any player holding an opponent before the ball is in play
- caution the player if the holding continues before the ball is in play
- award a direct free kick or penalty kick and caution the player if it happens once the ball is in play

If a defender starts holding an attacker outside the penalty area and continues holding him inside the penalty area, the referees must award a penalty kick.

Disciplinary sanctions

- A caution for unsporting behaviour must be issued when a player holds an opponent to prevent him gaining possession of the ball or taking up an advantageous position
- A player must be sent off if he denies an obvious goalscoring opportunity by holding an opponent
- No further disciplinary action must be taken in other situations of holding an opponent

Restart of play

- Direct free kick from the position where the offence occurred (see Law 13 – Position of free kick) or a penalty kick if the offence occurred inside the penalty area

Handling the ball

Handling the ball involves a deliberate act of a player making contact with the ball with his hand or arm. The referees must take the following into consideration:

- Movement of the hand towards the ball (not the ball towards the hand)
- The distance between the opponent and the ball (unexpected ball)
- The position of the hand does not necessarily mean that there is an infringement (holding it away from the body does not imply intent)
- Touching the ball with an object held in the hand (clothing, shinguard, etc.) counts as deliberately handling the ball
- Hitting the ball with a thrown object (a boot, shinguard, etc.) counts as deliberately handling the ball

Disciplinary sanctions

There are circumstances when a caution for unsporting behaviour is required when a player deliberately handles the ball, e.g. when a player:

- deliberately handles the ball to prevent an opponent gaining possession
- attempts to score a goal by deliberately handling the ball
- tries to prevent a goal or deny a goalscoring opportunity with his hand when the goalkeeper is not inside his penalty area, and fails in his attempt

A player is sent off, however, if he prevents a goal or an obvious goalscoring opportunity by deliberately handling the ball. This punishment arises not from the act of the player deliberately handling the ball but from the unacceptable and unfair intervention that prevented a goal from being scored.

Restart of play

- Direct free kick from the position where the offence occurred (see Law 13 – Position of free kick) or penalty kick

Outside his own penalty area, the goalkeeper has the same restrictions on handling the ball as does any other player. Inside his own penalty area, the goalkeeper cannot be guilty of a handling offence incurring a direct free kick. He can, however, be guilty of several offences that incur an indirect free kick.

Offences committed by goalkeepers

A goalkeeper is considered to be in control of the ball:

- while the ball is between his hands or between his hand and any surface (e.g. ground, own body)
- while holding the ball in his outstretched open hand
- while in the act of bouncing it on the ground or tossing it into the air

When a goalkeeper has gained possession of the ball with his hands, he cannot be challenged by an opponent.

Possession of the ball means that the goalkeeper has control of the ball.

A goalkeeper is not permitted to touch the ball inside his own half of the pitch in the following circumstances:

- If he is in possession of the ball in his own half of the pitch for more than four seconds, whether
 - with his hands inside his penalty area
 - with his feet in his own half of the pitch
 - with his hands inside his penalty area and with his feet in his own half of the pitch

In all these cases, the referee nearest to the goalkeeper must publicly make the four-second count:

- If, after playing the ball, he touches it again in his own half of the pitch after it has been deliberately played to him by a team-mate without an opponent playing or touching it
 - the goalkeeper is considered to be in control of the ball by touching it with any part of his body, except if the ball accidentally rebounds off him
- If he touches the ball with his hands inside his own penalty area after it has been kicked to him by a team-mate
- If he touches the ball with his hands inside his own penalty area after he has received it directly from a kick-in by a team-mate

Restart of play

- Indirect free kick from the position where the offence occurred (see Law 13 – Position of free kick)

Offences committed against goalkeepers

- It is an offence to prevent a goalkeeper from releasing the ball from his hands, e.g. when he bounces the ball
- Playing the ball or attempting to do so when the goalkeeper is holding it in the palm of his hand
- A player must be penalised for playing in a dangerous manner if he kicks or attempts to kick the ball when the goalkeeper is in the process of releasing it
- It is an offence to restrict the movement of the goalkeeper by unfairly impeding him, e.g. at the taking of a corner kick
- An attacker coming into physical contact with a goalkeeper inside the latter's own penalty area does not imply that any infringement has been committed, except if the attacker jumps at, charges or pushes the goalkeeper in a careless or reckless manner or using excessive force

Restart of play

- If play was stopped because of an offence committed against the goalkeeper as specified in the above paragraph and the referees cannot apply the advantage rule, thereby stopping play, play will be restarted with an indirect free kick from the position where the offence occurred (see Law 13 – Position of free kick), except if the attacker jumped at, charged or pushed the goalkeeper in a careless or reckless manner or using excessive force, in which case the referees, irrespective of the disciplinary action that they take, must restart play with a direct free kick from the position where the offence occurred (see Law 13 – Position of free kick)

Playing in a dangerous manner

Playing in a dangerous manner is defined as any action that, while trying to play the ball, threatens injury to an opposing player or himself. It is committed with an opponent nearby and prevents the opponent from playing the ball for fear of injuring himself or the other player.

A scissors or bicycle kick is permissible provided that, in the opinion of the referees, it is not dangerous to an opponent.

Playing in a dangerous manner does not necessarily involve physical contact between the players. If there is physical contact, the action becomes an offence punishable with a direct free kick or penalty kick. In the case of physical contact, the referees should carefully consider the likelihood that at the very least misconduct has also been committed.

Disciplinary sanctions

- If a player plays in a dangerous manner in a “normal” challenge, the referees should not take any disciplinary action. If the action is made with obvious risk of injury, the referees should caution the player for making a reckless challenge on an opponent
- If a player denies an obvious goalscoring opportunity by playing in a dangerous manner, the referees should send off the player

Restart of play

- Indirect free kick from the position where the offence occurred (see Law 13 – Position of free kick)
- If there is contact, a different offence has been committed, punishable by a direct free kick or penalty kick, or if the referees consider that the challenge was made in a careless or reckless manner or using excessive force, a different offence has been committed, punishable by a direct free kick or a penalty kick

Impeding the progress of an opponent

Impeding the progress of an opponent means moving into the path of the opponent to obstruct, block, slow down or force a change of direction by an opponent when the ball is not within playing distance of either player.

All players have a right to their position on the pitch; being in the way of an opponent is not the same as moving into the way of an opponent.

Shielding the ball is permitted. A player who places himself between an opponent and the ball for tactical reasons has not committed an offence as long as the ball is kept within playing distance and the player does not hold off the opponent with his arms or body.

Delaying the restart of play to issue a card

Once the referees have decided to issue a card, whether to caution or send off a player or a substitute, play must not be restarted until the sanction has been administered.

Cautions for unsporting behaviour

There are different circumstances when a player must be cautioned for unsporting behaviour, e.g. if a player:

- commits in a reckless manner one of the seven offences that incur a direct free kick
- commits a foul for the tactical purpose of interfering with or breaking up a promising attack
- holds an opponent for the tactical purpose of pulling the opponent away from the ball or preventing the opponent from getting to the ball
- handles the ball to prevent an opponent gaining possession or developing an attack (other than the goalkeeper inside his own penalty area)
- handles the ball in an attempt to score a goal (irrespective of whether or not the attempt is successful)
- handles the ball while pretending to play it with another part of his body in an attempt to deceive the referees
- tries to prevent a goal or deny a goalscoring opportunity with his hand, not being the goalkeeper inside his penalty area, and fails in his attempt
- attempts to deceive the referees by feigning injury or pretending to have been fouled (simulation)
- changes places with the goalkeeper during play without the referees' permission
- acts in a manner which shows a lack of respect for the game
- plays the ball when he is walking off the pitch after being granted permission to leave the pitch
- verbally distracts an opponent during play or at a restart
- makes unauthorised marks on the pitch
- uses a deliberate trick while the ball is in play to pass the ball to his own goalkeeper with his head, chest, knee, etc. in order to circumvent Law 12, irrespective of whether the goalkeeper touches the ball with his hands or not. The offence is committed by the player in attempting to circumvent both the letter and the spirit of Law 12 and play is restarted with an indirect free kick

Celebration of a goal

While it is permissible for a player to demonstrate his joy when a goal has been scored, the celebration must not be excessive.

Reasonable celebrations are allowed, but the practice of choreographed celebrations is not to be encouraged when it results in excessive time-wasting and referees are instructed to intervene in such cases.

A player must be cautioned if:

- in the opinion of the referees, he makes gestures which are provocative, derisory or inflammatory
- he climbs on to a perimeter fence to celebrate a goal being scored
- he removes his shirt or covers his head with his shirt, even if he has the same one on underneath
- he covers his head or face with a mask or other similar item

Leaving the pitch to celebrate a goal is permitted, but it is essential that players return to the pitch as soon as possible.

Showing dissent by word or action

A player or substitute who is guilty of dissent by protesting (verbally or non-verbally) against the decisions of the referees or assistant referees must be cautioned.

The captain of a team has no special status or privileges under the Futsal Laws of the Game but he has a degree of responsibility for the behaviour of his team.

Any player or substitute who attacks a match official or is guilty of using offensive, rude or obscene gestures or language must be sent off.

Delaying the restart of play

Referees must caution players who delay the restart of play by tactics such as:

- taking a free kick from the wrong position with the sole intention of forcing the referees to order a retake
- kicking the ball away or carrying it away with the hands after the referees have stopped play
- delaying their departure from the pitch after the medical staff come on to assess an injury they have suffered
- provoking a confrontation by deliberately touching the ball after the referees have stopped play

Simulation

Any player that tries to fool the referees by feigning injury or pretending to have suffered an offence will be guilty of simulation and will be punished for unsporting behaviour. If the match is stopped as a result of this infringement, play is restarted with an indirect free kick from the position where the offence was committed (see Law 13 – Position of free kick).

Persistent infringement

Referees should be alert at all times to players who persistently infringe the Futsal Laws of the Game. In particular, they must be aware that, even if a player commits a number of different offences, he must still be cautioned for persistently infringing the Futsal Laws of the Game.

There is no specific number of infringements which constitutes “persistence” or the presence of a pattern – this is entirely a matter of judgement and must be determined in the context of effective game management.

Serious foul play

A player is guilty of serious foul play if he uses excessive force or brutality against an opponent when challenging for the ball when it is in play.

A tackle that endangers the safety of an opponent must be sanctioned as serious foul play.

Any player who lunges at an opponent in challenging for the ball from the front, from the side or from behind using one or both legs, with excessive force and endangering the safety of an opponent is guilty of serious foul play.

Advantage should not be applied in situations involving serious foul play unless there is a clear subsequent opportunity to score a goal. In such a case, the referees send off the player guilty of serious foul play when the ball is next out of play.

A player who is guilty of serious foul play should be sent off and play is restarted with a direct free kick from the position where the offence occurred (see Law 13 – Position of free kick) or a penalty kick (if the offence occurred inside the offender's penalty area).

Violent conduct

A player is guilty of violent conduct if excessive force or brutality is used against an opponent without either of them challenging for the ball.

He is also guilty of violent conduct if he uses excessive force or brutality against a team-mate, spectator, the referees or assistant referees or any other person.

Violent conduct may occur either on the pitch or outside its boundaries, whether the ball is in play or not.

Advantage should not be applied in situations involving violent conduct unless there is a clear subsequent opportunity to score a goal. In such a case, the referees must send off the player guilty of violent conduct when the ball is next out of play.

Referees are reminded that violent conduct often leads to mass confrontation between players, therefore they must try to avert this with strict intervention.

A player or substitute who is guilty of violent conduct must be sent off.

Restart of play

- If the ball is out of play, play is restarted according to the previous decision
- If the ball is in play and the offence occurred outside the pitch:
 - if the player is outside the pitch after leaving it in a manner authorised by the Futsal Laws of the Game and commits an infringement, play is restarted with a dropped ball from the position of the ball when play was stopped, unless play was stopped inside the penalty area, in which case one of the referees drops the ball on the penalty area line at the point nearest to where the ball was located when play was stopped
 - if the player leaves the pitch to commit the offence, play is restarted with an indirect free kick from the position in which the ball was located when play was stopped (see Law 13 – Position of free kick)
- If the ball is in play and a player commits an offence inside the pitch:
 - against an opponent:
 - play is restarted with a direct free kick from the position where the offence occurred (see Law 13 – Position of free kick) or a penalty kick (if inside the offending player's own penalty area)
 - against a team-mate:
 - play is restarted with an indirect free kick from the position where the offence occurred (see Law 13 – Position of free kick)
 - against a substitute:
 - play is restarted with an indirect free kick to the team of the player who committed the violent conduct from the position of the ball when play was stopped (see Law 13 – Position of free kick), as the illegal entry of the substitute was the first offence committed
 - against the referees:
 - play is restarted with an indirect free kick from the position where the offence occurred (see Law 13 – Position of free kick)

- against another person:
 - play is restarted with a dropped ball from the position of the ball when play was stopped, unless play was stopped inside the penalty area, in which case one of the referees drops the ball on the penalty area line at the point nearest to where the ball was located when play was stopped
- If the ball is in play and a substitute or team official commits an offence outside the pitch:
 - against another person:
 - play is restarted with a dropped ball from the position of the ball when play was stopped, unless play was stopped inside the penalty area, in which case one of the referees drops the ball on the penalty area line at the point nearest to where the ball was located when play was stopped

Offence where an object is thrown

If, while the ball is in play, a player or substitute throws an object or a ball at an opponent or any other person in a reckless manner, the referees stop play if they cannot apply the advantage and caution the player or substitute.

If, while the ball is in play, a player or substitute throws an object or a ball at an opponent or any other person with excessive force, the referees stop play if they cannot apply the advantage to allow an obvious goalscoring opportunity to ensue and send off the player or substitute for violent conduct.

Restart of play

- If a player standing inside his own penalty area throws an object or a ball at an opponent standing outside the penalty area, the referees restart play with a direct free kick to the opposing team taken from the position where the object struck or would have struck the opponent (see Law 13 – Position of free kick)
- If a player standing outside his own penalty area throws an object or a ball at an opponent standing inside the penalty area, the referees restart play with a penalty kick to the opposing team

- If a player standing inside the pitch throws an object or a ball at any person standing outside the pitch, the referees restart play with an indirect free kick to the opposing team from the position of the ball when play was stopped (see Law 13 – Position of free kick); the player is considered to have left the pitch without the referees' permission and for a reason not authorised in the Futsal Laws of the Game
- If a player standing outside the pitch throws an object or a ball at an opponent standing inside the pitch, the referees restart play with a direct free kick to the opposing team from the position where the object struck or would have struck the opponent or with a penalty kick (if inside the offending player's own penalty area)
- If a substitute standing outside the pitch throws an object or a ball at an opponent standing inside the pitch, the referees restart play with an indirect free kick to the opposing team from the position of the ball when play was stopped (see Law 13 – Position of free kick); the substitute is considered to have entered the pitch without the referees' permission and without following the substitution procedure
- If a substitute standing inside the pitch, causing his team to have an extra player, throws an object or a ball at any person standing inside or outside the pitch, the referees restart play with an indirect free kick to the opposing team from the position of the ball when play was stopped (see Law 13 – Position of free kick); the substitute is considered to have entered the pitch without the referees' permission
- If a substitute who has infringed the substitution procedure throws an object or the ball at any person standing inside or outside the pitch, he is treated as if he were a player
- If a team official standing inside or outside the pitch throws an object or a ball at any person standing inside or outside the pitch, the referees restart play with a dropped ball from the position of the ball when play was stopped, unless play was stopped inside the penalty area, in which case one of the referees drops the ball on the penalty area line at the point nearest to where the ball was located when play was stopped

Offences where an object is thrown at the ball

If a player other than one of the goalkeepers throws an object or a ball at the ball:

- if the ball is in play and the object strikes the ball, the referees must stop play and caution him for unsporting behaviour or send him off if by doing so he denied a goal or an obvious goalscoring opportunity. They restart play with a direct free kick to the opposing team from the position of the ball when play was stopped (see Law 13 – Position of free kick) or a penalty kick if the ball was inside the offending team's penalty area
- if the ball is in play and the object does not strike the ball, the referees must stop play if they cannot apply the advantage and caution him for unsporting behaviour. They restart play with an indirect free kick to the opposing team from the position of the ball when play was stopped (see Law 13 – Position of free kick)

If one of the two goalkeepers throws an object or a ball at the ball:

- if the ball is in play and the object strikes the ball inside the goalkeeper's penalty area, the referees must stop play and caution him for unsporting behaviour. They restart play with an indirect free kick to the opposing team from the position of the ball when play was stopped (see Law 13 – Position of free kick)
- if the ball is in play and the object strikes the ball outside the goalkeeper's penalty area, the referees must stop play and caution him for unsporting behaviour or send him off if by doing so he denied a goal or an obvious goalscoring opportunity. They restart play with a direct free kick to the opposing team from the position of the ball when play was stopped
- if the ball is in play and the object does not strike the ball, the referees must stop play if they cannot apply the advantage and caution him for unsporting behaviour. They restart play with an indirect free kick to the opposing team from the position of the ball when play was stopped (see Law 13 – Position of free kick)

If a player, including the two goalkeepers, directs an object at the ball with a part of his body other than his hands:

- if the ball is in play and the object strikes the ball, the referees must stop play and caution him for unsporting behaviour. They restart play with an indirect free kick to the opposing team from the position of the ball when play was stopped (see Law 13 – Position of free kick)
- if the ball is in play and the object does not strike the ball, the referees must stop play if they cannot apply the advantage and caution him for unsporting behaviour. They restart play with an indirect free kick to the opposing team from the position of the ball when play was stopped (see Law 13 – Position of free kick)

If a substitute infringing the substitution procedure but not causing his team to play with an extra player throws an object at the ball:

- if the ball is in play and the object strikes the ball, the referees must stop play and either send him off for a double caution, the first caution for entering the pitch without following the substitution procedure and the second for unsporting behaviour, or send him off directly if by doing so he denied a goal or an obvious goalscoring opportunity. They restart play with a direct free kick to the opposing team from the position of the ball when play was stopped (see Law 13 – Position of free kick) or a penalty kick if the ball was inside the substitute's penalty area
- if the ball is in play and the object does not strike the ball, the referees must stop play if they cannot apply the advantage and send him off for a double caution, the first caution for entering the pitch without following the substitution procedure and the second for unsporting behaviour. They restart play with an indirect free kick to the opposing team from the position of the ball when play was stopped (see Law 13 – Position of free kick)

If a substitute infringing the substitution procedure but not causing his team to be playing with an extra player directs an object at the ball with a part of his body other than his hands:

- if the ball is in play and the object strikes the ball, the referees must stop play and either send him off for a double caution, the first caution for entering the pitch without following the substitution procedure and the second for unsporting behaviour, or send him off directly if by doing so he denied a goal or an obvious goalscoring opportunity. They restart play with an indirect free kick to the opposing team from the position of the ball when play was stopped (see Law 13 – Position of free kick)
- if the ball is in play and the object does not strike the ball, the referees must stop play if they cannot apply the advantage and send him off for a double caution, the first caution for entering the pitch without following the substitution procedure and the second for unsporting behaviour. They restart play with an indirect free kick to the opposing team from the position of the ball when play was stopped (see Law 13 – Position of free kick)

If a substitute throws an object at the ball, thus causing his team to be playing with an extra player:

- if the ball is in play and the object strikes the ball, the referees must stop play and either send him off for a double caution, both for unsporting behaviour, the first caution for entering the pitch without the referees' permission and the second for throwing the object, or send him off directly if by doing so he denied a goal or an obvious goalscoring opportunity. They restart play with an indirect free kick to the opposing team from the position of the ball when play was stopped (see Law 13 – Position of free kick)
- if the ball is in play and the object does not strike the ball, the referees must stop play if they cannot apply the advantage and send him off for a double caution, both for unsporting behaviour, the first caution for entering the pitch without the referees' permission and the second for throwing the object. They restart play with an indirect free kick to the opposing team from the position of the ball when play was stopped (see Law 13 – Position of free kick)

If a substitute directs an object at the ball with a part of his body other than his hands, thus causing his team to be playing with an extra player:

- if the ball is in play and the object strikes the ball, the referees must stop play and either send him off for a double caution, both for unsporting behaviour, the first caution for entering the pitch without the referees' permission and the second for directing the object, or send him off directly if by doing so he denied a goal or an obvious goalscoring opportunity. They restart play with an indirect free kick to the opposing team from the position of the ball when play was stopped (see Law 13 – Position of free kick)
- if the ball is in play and the object does not strike the ball, the referees must stop play if they cannot apply the advantage and send him off for a double caution, both for unsporting behaviour, the first caution for entering the pitch without the referees' permission and the second for throwing the object. They restart play with an indirect free kick to the opposing team from the position of the ball when play was stopped (see Law 13 – Position of free kick)

If a team official directs an object at the ball with any part of his body:

- if the ball is in play and the object strikes the ball, the referees must stop play and expel him from the technical area and its surrounds. Play is restarted with a dropped ball from the position of the ball when play was stopped, unless play was stopped inside the penalty area, in which case one of the referees drops the ball on the penalty area line at the point nearest to where the ball was located when play was stopped
- if the ball is in play and the object does not strike the ball, the referees must stop play if they cannot apply the advantage and expel him from the technical area and its surrounds. Play is restarted with a dropped ball from the position of the ball when play was stopped, unless play was stopped inside the penalty area, in which case one of the referees drops the ball on the penalty area line at the point nearest to where the ball was located when play was stopped

If the ball is not in play and a player throws an object at the ball, the referees caution him for unsporting behaviour. Play is restarted in accordance with the Futsal Laws of the Game.

If the ball is not in play and a substitute throws an object at the ball, whether he causes his team to be playing with an extra player or not, the referees send him off for a double caution, both for unsporting behaviour, the first caution for entering the pitch without the referees' permission and the second for throwing the object.

If the ball is not in play and a team official throws an object at the ball, the referees expel him from the technical area and its surrounds.

Denying a goal or a goalscoring opportunity

There are two sending-off offences that deal with denying an opponent an obvious opportunity to score a goal. It is not necessary for the offence to occur inside the penalty area.

If the referees apply the advantage during an obvious goalscoring opportunity and a goal is scored directly, despite the opponent handling the ball deliberately, the player cannot be sent off but he may still be cautioned.

If the referees apply the advantage during an obvious goalscoring opportunity and a goal is scored directly, despite the opponent committing a foul, the player cannot be sent off for the foul itself but he may still be cautioned or sent off if the action in itself warrants a caution or sending-off.

Referees should consider the following circumstances when deciding whether to send off a player for denying a goal or an obvious goalscoring opportunity:

- The distance between the offence and the goal
- The likelihood of keeping or gaining control of the ball
- The direction of the play
- The location and number of defenders
- The offence which denies an opponent an obvious goalscoring opportunity may be an offence that incurs a direct free kick or an indirect free kick
- If the infringement is committed by a substitute, he must always be sent off

If a player attempts to prevent a goal by deliberately handling the ball after a restart of play in which it is not possible to score a goal directly, he is not sent off, but is cautioned for unsporting behaviour. His team is penalised by a direct free kick or a penalty kick.

If a substitute enters the pitch with the aim of denying a goal or a goalscoring opportunity, he is sent off whether or not he achieves his objective.

Procedure

- The ball is in play when it is kicked and moves
- A free kick can be taken by lifting the ball with a foot or both feet simultaneously
- Feinting to take a free kick to confuse opponents is permitted as part of futsal. However, if in the opinion of the referees the feinting is considered an act of unsporting behaviour, the player must be cautioned
- If a player, while correctly taking a free kick, intentionally kicks the ball at an opponent in order to play the ball again but neither in a careless nor a reckless manner nor using excessive force, the referees must allow play to continue
- An indirect free kick must be retaken if the referees fail to raise their arms to indicate that the kick is indirect and the ball is kicked directly into the goal. The initial indirect free kick is not nullified by the referees' mistake
- If, as part of a playing movement, a goalkeeper ends up outside his goal or he or any other player end up outside the pitch, the opposing team may take a direct free kick quickly, provided that they have not committed their sixth accumulated foul
- If the ball bursts after hitting one of the goalposts or the crossbar and does not enter the goal, the referees do not order the free kick to be retaken; they stop play and restart it with a dropped ball from the position of the ball when it burst (see Law 8 – Dropped ball)
- If the player taking a direct free kick, beginning with a team's sixth accumulated foul, kicks the ball forward to enable a team-mate to strike at goal, the referees stop play if they cannot apply the advantage and restart it with an indirect free kick from the place where the kicker's team-mate touched the ball (see Law 13 – Position of free kick)
- If the referees order a free kick to be retaken, the new free kick can be taken by any player and does not have to be taken by the player who did so originally
- If a player takes a direct or indirect free kick before the referees give the signal for it to be taken and before a team's sixth accumulated foul, provided that the team taking the kick has requested their opponents to respect the required distance, the referees stop play if they cannot apply the advantage, order the free kick to be retaken and caution the player

- If a player takes a direct free kick before the referees give the signal for it to be taken, beginning with a team's sixth accumulated foul, they order the free kick to be retaken and caution him
- If a period of play is extended to allow a direct free kick to be taken, beginning with the sixth accumulated foul, and the ball hits one of the goalposts or the crossbar or the goalkeeper before crossing the goal line between the goalposts and the crossbar, the referees award a goal
- If a period of play is extended to allow a direct free kick to be taken, beginning with the sixth accumulated foul, the referees allow the defending goalkeeper to be replaced by an outfield player or an eligible substitute, although in the latter case the substitution procedure must be followed

Distance

If a player decides to take a free kick quickly and an opponent who is less than 5m from the ball intercepts it, the referees must allow play to continue.

If a player decides to take a free kick quickly and an opponent who is near the ball deliberately prevents him from taking the kick, the referees must caution the opponent for delaying the restart of play.

If, when a free kick is taken by the defending team from inside its own penalty area, one or more opponents remain inside the penalty area because the defender decided to take the kick quickly and the opponents did not have time to leave the penalty area, the referees must allow play to continue if the ball leaves the penalty area directly without touching another player.

Infringements beginning with the sixth accumulated foul – after the whistle and before the ball is in play

Infringements	Outcome of the kick	
	Goal	No goal
Attacking player	Free kick is retaken	Indirect free kick
Kicker does not shoot at goal	—	Indirect free kick
Kick by unidentified player	Indirect free kick	Indirect free kick
Defending player	Goal	Free kick is retaken
By both teams	Free kick is retaken	Free kick is retaken

Procedure

- Feinting in the run-up to take a penalty kick to confuse opponents is permitted as part of futsal. However, feinting to kick the ball once the player has completed his run-up is considered an infringement of Law 14 and an act of unsporting behaviour for which the player must be cautioned
- If the ball bursts after hitting one of the goalposts or the crossbar and enters the goal, the referees award the goal
- If the ball bursts after hitting one of the goalposts or the crossbar and does not enter the goal, the referees do not order the penalty kick to be retaken but stop play, which is restarted with a dropped ball on the penalty area line at the point nearest to where the ball was located when it burst
- If the player taking the penalty kick kicks the ball forward to enable a teammate to shoot at goal, the referees allow the goal if the procedure for the penalty kick stipulated in Law 14 was observed
- If the referees order the penalty kick to be retaken, the new penalty kick can be taken by any player and does not have to be taken by the player who did so originally
- If the kicker takes the penalty kick before the referees give the signal, they order the penalty kick to be retaken and caution him
- If a period of play is extended to allow a penalty kick to be taken and the ball hits one of the goalposts or the crossbar or the goalkeeper before crossing the goal line between the goalposts and the crossbar, the referees award a goal
- If a period of play is extended to allow a penalty kick to be taken, the referees allow the defending goalkeeper to be replaced by an outfield player or an eligible substitute, although in the latter case the substitution procedure must be followed

Preparing for the penalty kick

The referees must confirm the following requirements before the penalty kick is taken:

- The kicker is identified
- The ball is properly placed on the penalty mark
- The goalkeeper is on the goal line between the goalposts and facing the kicker
- The team-mates of the kicker are:
 - outside the penalty area
 - 5m from the ball
 - behind the ball

Infringements – after the whistle and before the ball is in play

Infringements	Outcome of the kick	
	Goal	No goal
Attacking player	Penalty is retaken	Indirect free kick
Kicker kicks backwards	Indirect free kick	Indirect free kick
Kick by unidentified player	Indirect free kick	Indirect free kick
Defending player	Goal	Penalty is retaken
By both teams	Penalty is retaken	Penalty is retaken

If an attacker or defender commits an infringement on an opposing player before the ball is in play, but after one of the referees has given the order to take the kick, they allow the kick to be taken. If a goal is scored and the infringement was committed by the defending team, they award a goal; if the infringement was committed by the attacking team, they order the penalty kick to be retaken. If no goal is scored and the infringement was committed by the defending team, they order the penalty kick to be retaken; if the infringement was committed by the kicker's team, they penalise his team with an indirect free kick from the place where the infringement was committed (see Law 13 – Position of free kick). Furthermore, the referees take the appropriate disciplinary action.

Procedure for infringements

Referees are reminded that opponents may be no closer than 5m from the point at which the kick-in is to be taken. Where necessary, the referees must warn any player within this distance before the kick-in is taken and caution the player if he subsequently fails to retreat to the correct distance. Play is restarted with a kick-in, and the four-second count begins again if it has already started.

If a player, while correctly taking a kick-in, intentionally kicks the ball at an opponent in order to play the ball again but neither in a careless nor a reckless manner nor using excessive force, the referees must allow play to continue.

If the ball enters the opponents' goal directly from a kick-in, the referees must award a goal clearance. If the ball enters the taker's own goal directly from a kick-in, the referees must award a corner kick.

If the ball does not enter the pitch from a kick-in, the referees shall order a player from the opposing team to take it.

If a goalkeeper, as part of a playing movement, ends up outside his goal or he or any other player end up outside the pitch, the opposing team may take the kick-in quickly.

If a kick-in is taken incorrectly, the referees may not apply the advantage even if the ball goes directly to an opponent, but order a player from the opposing team to retake it.

Procedure for infringements

If an opponent enters the penalty area or is still in it before the ball is in play and is fouled by a player from the defending team, the goal clearance is retaken and the defender may be cautioned or sent off depending on the nature of the offence.

If, when a goal clearance is taken by the goalkeeper, one or more opponents are still inside the penalty area because the goalkeeper decided to take the clearance quickly and the opponents did not have time to leave the area, the referees must allow play to continue if the ball leaves the penalty area directly without touching another player.

If the goalkeeper, while correctly taking a goal clearance, intentionally throws the ball at an opponent located outside the penalty area but neither in a careless nor a reckless manner nor using excessive force, the referees must allow play to continue.

If, when taking the goal clearance, the goalkeeper does not release the ball from inside his penalty area, the referees order the goal clearance to be retaken, although the four-second count continues from where it was stopped once the goalkeeper is ready to retake it.

It is not necessary for the goalkeeper to have the ball in his hands before the referees begin the four-second count.

If a goalkeeper who has taken a goal clearance correctly intentionally touches the ball with his hand after it has left the penalty area before another player has touched it, the referees, in addition to awarding a direct free kick to the opposing team, may take disciplinary action against him in accordance with the Futsal Laws of the Game.

If the goalkeeper takes the goal clearance with his foot, the referees will issue a warning and order him to take it with his hand, but the four-second count continues from where it was stopped once the goalkeeper is ready to retake it.

If a goalkeeper, as part of a playing movement, ends up outside his goal or he or any other player end up outside the pitch, the opposing goalkeeper may take a goal clearance quickly.

If the goalkeeper takes a goal clearance and the ball crosses his goal line without first leaving the penalty area, the referees order the goal clearance to be retaken, but the four-second count continues from where it was stopped once the goalkeeper is ready to retake it.

If, when taking a goal clearance, the ball hits one of the referees inside the penalty area without first leaving the area and enters into play, the referees take no action.

Procedure for infringements

Referees are reminded that opponents must remain at least 5m from the corner arc until the ball is in play. Where necessary, the referees must warn any player within this distance before the corner is taken and caution the player if he subsequently fails to retreat to the correct distance.

If a player, while correctly taking a corner, intentionally kicks the ball at an opponent in order to play the ball again but neither in a careless nor a reckless manner nor using excessive force, the referees must allow play to continue.

The ball must be placed inside the corner arc and is in play when it is kicked, therefore the ball does not need to leave the corner arc to be in play.

If a goalkeeper, as part of a playing movement, ends up outside his goal or he or any other player end up outside the pitch, the opposing team may take the corner quickly.

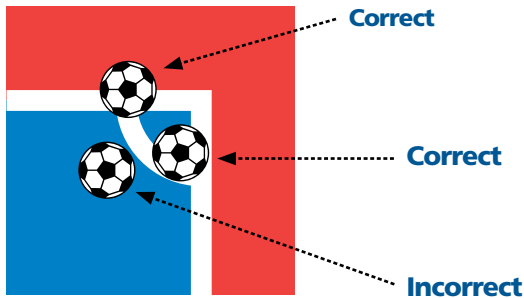

Extra time

Procedure

- The two periods of extra time are not part of the match
- Players or substitutes may be cautioned or sent off during the two periods of extra time
- Accumulated fouls during the periods of extra time are added to those from the second half of the match
- During the periods of extra time the teams are not entitled to time-outs, even if they have not used their time-out corresponding to the second half of the match

Kicks from the penalty mark

Procedure

- The kicks from the penalty mark are not part of the match
- The penalty area where the kicks from the penalty mark are being taken may be changed only if the goal or the playing surface becomes unusable or for safety reasons
- Once all eligible players have taken a kick from the penalty mark, the same sequence does not have to be followed as in the first round of kicks
- Each team is responsible for selecting the players to take kicks from the penalty mark from among the players and substitutes and the order in which they will take the kicks and must inform the third referee before the kicks are taken
- With the exception of the goalkeeper, once the kicks from the penalty mark have started, an injured player may not be replaced by an ineligible player, if there are any
- If the goalkeeper is sent off during the kicks from the penalty mark, he may be replaced by an eligible player, but not by another goalkeeper if he was excluded from taking the kicks from the penalty mark
- A player or substitute may be cautioned or sent off during the taking of kicks from the penalty mark
- The referees must not abandon the series of kicks from the penalty mark if a team is reduced to fewer than three players during the taking of kicks from the penalty mark

- If a player is injured or sent off during the taking of kicks from the penalty mark and the team has one player fewer, the referees should not reduce the number of players taking kicks for the other team
- An equal number of players from each team is required only at the start of the taking of kicks from the penalty mark
- If the ball hits one of the goalposts or the crossbar or the goalkeeper before crossing the goal line between the goalposts and the crossbar, the referees allow the goal
- If the ball bursts or becomes defective after striking one of the goalposts or the crossbar and enters the goal, the referees allow the goal
- If the ball bursts or becomes defective after hitting one of the goalposts or the crossbar and does not enter the goal, the referees do not order the penalty kick to be retaken and deem the penalty kick to have been taken
- If the competition rules require kicks from the penalty mark to determine the winner of a match or home-and-away and the teams refuse to do so, the referees report the incident to the relevant authorities
- If, before the penalty kicks start, one or more eligible players leave the pitch or refuse to take the penalty kicks once these have started and are not injured, the referees abandon the taking of kicks from the penalty mark and inform the relevant authorities
- During the taking of the penalty kicks, the referees do not allow cameras or other media on the pitch

سایت آموزشی و تفریحی

تک مگابایت

TakMb.ir