

---

# THERMAL ANALYSIS

---

## Overview

In this white paper we define and then outline the concept of thermal analysis as it relates to product design. We discuss the principles of conduction, convection, and radiation using real-life products as examples. We will also describe ways to perform thermal analysis, specifically how you can use design validation software to simulate thermal conditions. We will also list the desired capabilities in thermal design validation software and demonstrate through examples how you can solve design challenges using Dassault Systèmes SolidWorks Corp. products.

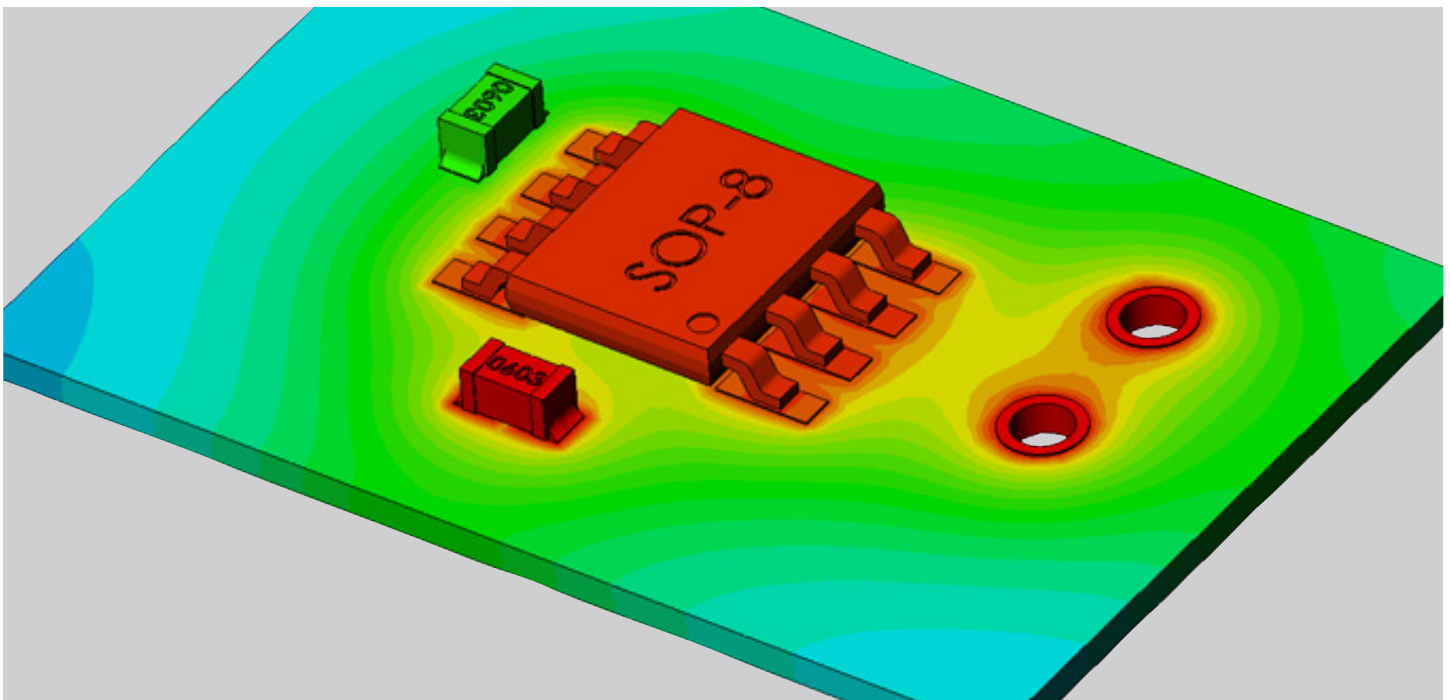

## Introduction to thermal analysis

To reduce product development cost and time, traditional prototyping and testing has largely been replaced in the last decade by a simulation-driven design process. Such a process, which reduces the need for expensive and time-consuming physical prototypes, allows engineers to successfully predict product performance with easy-to-modify computer models (Figure 1).

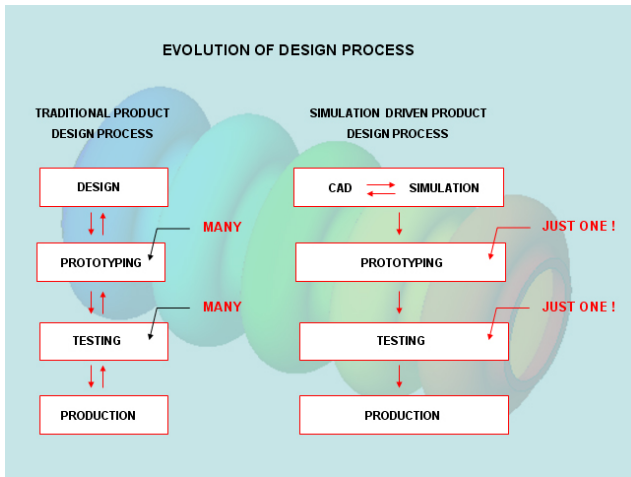

Figure 1: Traditional versus simulation-driven product design processes

Design verification tools are considered invaluable in studying such structural problems as deflections, deformations, stresses, or natural frequencies. However, the structural performance of new products is only one of many challenges facing design engineers. Other common problems are thermally related, including overheating, the lack of dimensional stability, excessive thermal stresses, and other challenges related to heat flow and the thermal characteristics of their products.

Thermal problems are very common in electronics products. The design of cooling fans and heat sinks must balance the need for small size with adequate heat removal. At the same time, tight component packaging must still ensure sufficient air flow so that printed circuit boards do not deform or crack under excessive thermal stress (Figure 2).



Figure 2: Electronic packaging requires careful analysis of how heat produced by electronic components is removed to the environment.

Thermal challenges also abound in traditional machine design. Obvious examples of products that must be analyzed for temperature, heat dissipation, and thermal stresses are engines, hydraulic cylinders, electric motors or pumps—in short, any machine that uses energy to perform some kind of useful work.

Perhaps less obvious candidates for thermal analysis are material processing machines where mechanical energy turns into heat, affecting not only the machined piece but also the machine itself. This situation is important not only in precision machining equipment, where thermal expansion may affect the dimensional stability of the cutting tool, but also in high power machines such as shredders, where components may suffer from excessive temperature and thermal stresses (Figure 3).



Figure 3: Potential overheating of an industrial shredder is an important consideration in the design of its transmission and bearings.

As a third example, most medical devices should be analyzed for thermal performance. Drug-delivery systems must assure proper temperature of the administered substance while surgical devices must not subject the tissue to excessive thermal shock. Similarly, body implants must not disrupt heat flow inside the body, while dental implants must also withstand severe external mechanical and thermal loads (Figure 4).



Figure 4: Dental implants must not affect thermal conditions of the surrounding tissue and must also withstand thermal stresses.

Finally, all electrical appliances such as stoves, refrigerators, mixers, irons, and coffee makers—in short, anything that runs on electricity—should be analyzed for thermal performance to avoid overheating. This applies not only to consumer products that run off AC power, but also to battery-operated devices such as remote-controlled toys and cordless power tools (Figure 5).



Figure 5: Adequate cooling of a high capacity battery on a cordless tool requires understanding the thermal conditions.

### Using design validation for thermal analysis

All of the above thermal design problems and many more can be simulated with design validation software. Most design engineers are already familiar with this approach for structural analysis, so expanding its scope to thermal analysis requires very little additional training. Structural and thermal simulations are based on exactly the same concepts, follow the same well-defined steps, and share multiple analogies (Figure 6).

Furthermore, thermal analyses are performed on CAD models the same way as structural analyses so, once a CAD model has been created, a thermal verification can be completed with very little extra effort.

Thermal analyses can be executed to find temperature distribution, temperature gradient, and heat flowing in the model, as well as the heat exchanged between the model and its environment.

Structural Analysis	Thermal analysis
Displacement	Temperature
Strain	Temperature gradient
Stress	Heat flux

Figure 6: Analogies between structural and thermal design validation

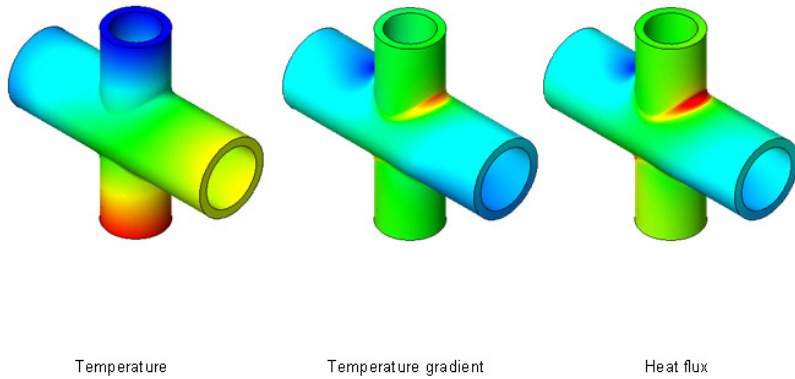

Figure 7: Typical results provided by thermal design validation

Heat transfer mechanism	Main characteristics
<b>Conduction</b>	Responsible for heat flow inside a solid body
<b>Convection</b>	Responsible for heat entering and escaping a solid body. Heat transfer by convection requires the solid body to be surrounded by a fluid like air, water, oil etc.
<b>Radiation</b>	Responsible for heat entering and escaping a solid body. Heat transfer by radiation does not require any fluid surrounding the body; it takes place in fluid as well as in vacuum Heat transfer by radiation is always present but becomes noticeable only at higher temperatures.

Figure 8: Main characteristics of three heat transfer mechanisms

Thermal effects such as temperatures are easy to simulate, but may be quite difficult to measure, especially inside parts or assemblies, or if temperatures are changing rapidly. This often means that software-based design validation may indeed be the only method available to engineers interested in the detailed thermal conditions of their products.

## Heat transfer fundamentals

### Conduction and convection

There are three mechanisms responsible for heat transfer: conduction, convection, and radiation. Conduction describes heat flowing inside a body, with the latter most often modeled as a CAD part or assembly. Conduction and radiation both involve heat exchange between the solid body and the environment.

An example of heat transfer by conduction is heat flow across a wall. The amount of transferred heat is proportional to the temperature difference between the hot side  $T_{HOT}$  and the cold side  $T_{COLD}$  of the wall, to the area  $A$  of the wall, and to the reciprocal of the wall thickness  $L$ . The proportionality factor  $K$ , called thermal conductivity, is a well-known material property (Figure 9).

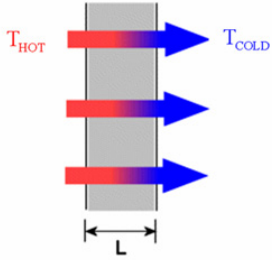

$$Q_{CONDUCTION} = K A (T_{HOT} - T_{COLD}) / L$$

Figure 9: Heat is conducted through the wall from the higher to the lower temperature.

Thermal conductivity  $K$  varies widely for different materials; this factor is what differentiates between heat conductors and insulators (Figure 10).

The mechanism of heat exchange between an external face of a solid body and the surrounding fluid such as air, steam, water, or oil is called convection. The amount of heat moved by convection is proportional to the temperature difference between the solid body face  $TS$  and the surrounding fluid  $TF$ , and to the area  $A$  of the face exchanging (dissipating or gaining) heat. The proportionality factor  $h$  is called the convection coefficient, also known as a film coefficient. Heat exchange between the surface of a solid body and its surrounding fluid requires movement of the fluid (Figure 11).

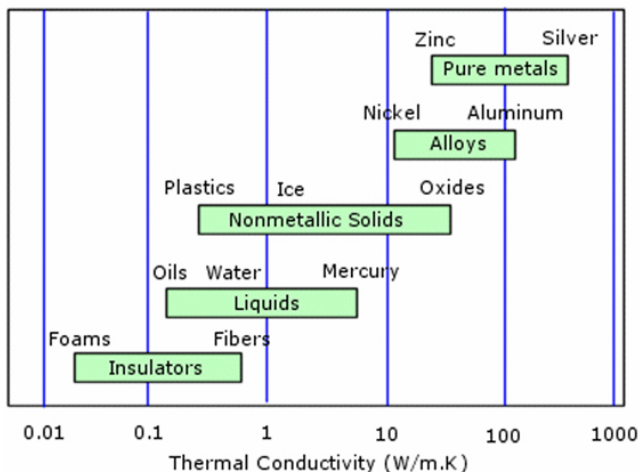
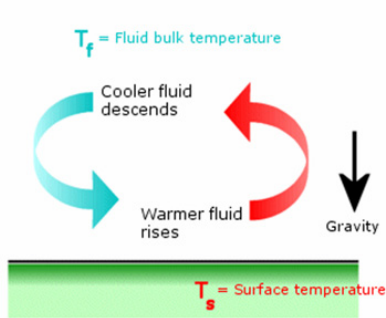

Figure 10: Conduction coefficients for different materials



$$Q_{\text{CONVECTION}} = h A (T_s - T_f)$$

Figure 11: Heat dissipated by convection always requires movement of the fluid surrounding the body.

The convection coefficient strongly depends on the medium (e.g., air, steam, water, oil) and the type of convection: natural or forced. Natural convection can only take place in the presence of gravity because fluid movement is dependent on the difference between the specific gravity of cold and hot fluids. Forced convection is not dependent on gravity (Figures 12, 13).

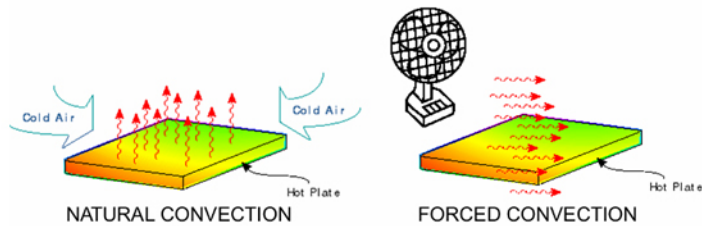

Figure 12: Natural convection is induced by a difference in hot and cold fluid density. In forced convection, fluid movement is forced, for example, by a cooling fan.

Medium	Heat Transfer Coefficient $h$ ( $W/m^2 \cdot K$ )
Air (natural convection)	5-25
Air/superheated steam (forced convection)	20-300
Oil (forced convection)	60-1800
Water (forced convection)	300-6000
Water (boiling)	3000-60,000
Steam (condensing)	6000-120,000

Figure 13: Heat convection coefficients for different media and for different types of convection.

To see how conduction and convection work together, consider a heat-sink assembly (Figure 14). A microchip generates heat throughout its entire volume. Heat moves within the microchip by conduction then is transferred to an aluminum radiator where it also travels by conduction. As heat travels from the porcelain microchip to the aluminum radiator, it must overcome a thermal resistance layer formed by imperfections at the porcelain-aluminum interface. Finally, heat is dissipated by convection from the outside faces of the radiator to the surrounding air.

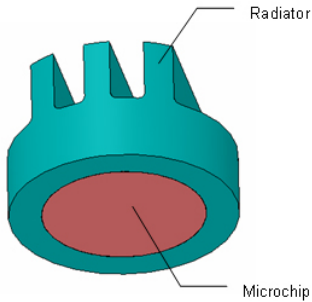

Figure 14: A ceramic microchip generating heat is embedded in an aluminum radiator. The radiator is cooled by the surrounding air.

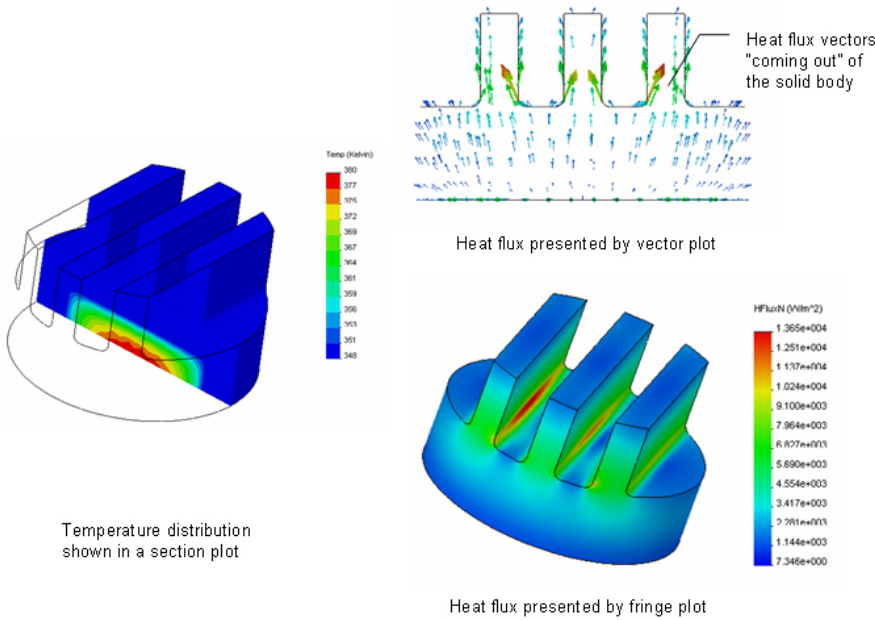

Figure 15

Figure 15: Temperature distribution and heat flux in the heat-sink assembly

Adding a cooling fan or immersing the radiator in water does not change the mechanism of heat transfer. Heat is still removed from the radiator faces by convection. The only difference between air and water acting as coolants and between natural and forced convections is a different value of convection coefficient.



The temperature field in the heat-sink assembly is shown in Figure 15. The movement of heat from the radiator face to the ambient air can be pictured by plotting heat-flux vectors (Figure 15, right). Heat flux vectors “coming out” of the radiator faces visualize heat removed to the surrounding fluid. No vectors cross the bottom face because in the model the bottom faces of the radiator and microchip are insulated.

Note that modeling the heat flowing in the heat-sink assembly requires accounting for a resistance to heat flow at the interface between the ceramic microchip and the aluminum radiator. In some design verification programs, the thermal resistance layer must be modeled explicitly; in others, like SolidWorks software, it can be entered in a simplified way as a thermal resistance coefficient.

**Conduction, convection and radiation**

So far this discussion of heat transfer in the heat-sink assembly considers only two heat-flow mechanisms: conduction (responsible for moving heat inside the solid bodies: microchip and radiator) and convection (which dissipates heat from the external faces of the radiator to the ambient air). Heat transfer by radiation can be ignored because at the operating temperature of heat-sink radiation, heat transfer is very low. The next example highlights a heat transfer problem where radiation can’t be ignored.

Radiation can move heat between two bodies of different temperatures or it can radiate heat into space. It does not depend on whether or not the bodies are immersed in a fluid or are surrounded by a vacuum (Figure 16).

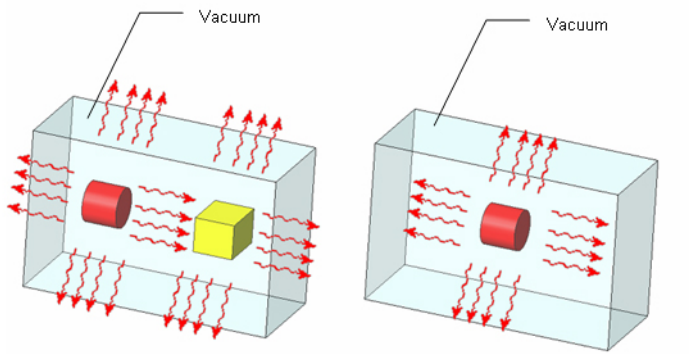

Heat is exchanged by radiation between two bodies and is radiated out to space

Heat is radiated from the body out to space

$$Q_{\text{RADIATION}} = \sigma \epsilon ( T_1^4 - T_2^4 )$$

Figure 16: Heat is exchanged by radiation between any two bodies of different temperatures. Heat can also be radiated by a single body out to space.

The amount of heat exchanged by radiation between the faces of two solid bodies with temperatures  $T_1^{\circ}$  and  $T_2^{\circ}$  is proportional to the difference of the fourth power of absolute temperatures to the area  $A$  of the faces participating in the heat transfer, and to the emissivity of the radiating surface. Emissivity is defined as the ratio of the emissive power of the surface to the emissive power of a blackbody at the same temperature. Materials are assigned an emissivity value between 0 and 1.0. A blackbody, therefore, has an emissivity of 1.0 and a perfect reflector has an emissivity of 0. Because heat transfer by radiation is proportional to the fourth power of the absolute temperature, it becomes very significant at higher temperatures.

Consider a spotlight providing illumination in a large vacuum chamber. Assume that the vacuum chamber is so large that any heat reflected from the chamber walls back to the spotlight can be ignored. The lightbulb and reflector are exposed to a vacuum, while the back side of the aluminum housing is surrounded by air (Figure 17).

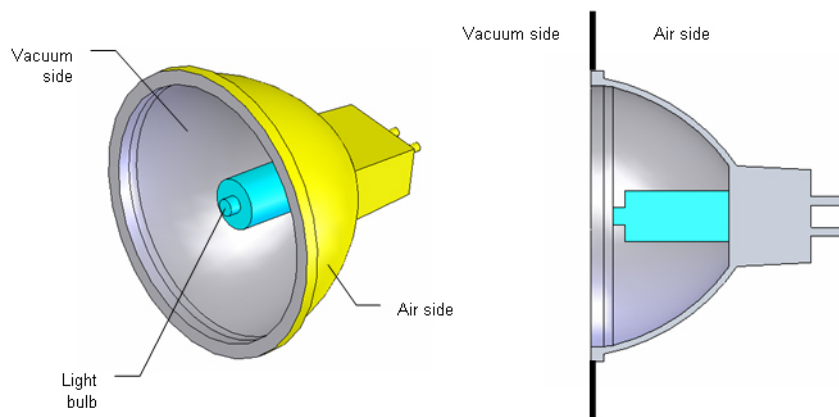

Figure 17: In the spotlight model, the reflector and light bulb are exposed to a vacuum and the back side of the housing is exposed to air

The heat generated by the light bulb is partially radiated out to space, while the rest is received by the parabolic face (reflector) of the housing. Only a very small portion of heat enters the housing by conduction where the light bulb is attached to the housing. The radiated heat received by the housing is again split into two portions: the first is radiated out, and the second is moved inside the housing volume from the vacuum side to the air side. Once it reaches the face exposed to air, it is dissipated by convection.

As analysis results indicate, the temperature of the aluminum housing is practically uniform because heat is conducted easily in aluminum due to its high conductivity (Figure 18).

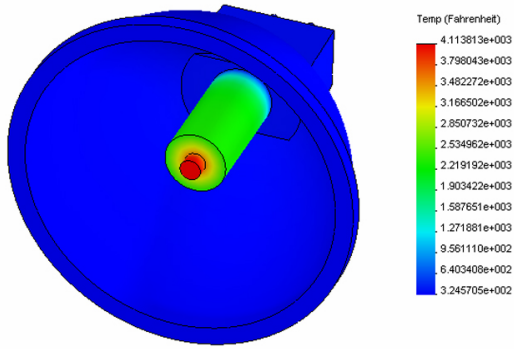

Figure 18: temperature distribution in a spotlight

Note that since radiation heat-transfer becomes effective only at high temperatures, the light bulb must run very hot to dissipate all the heat it produces.

### Transient thermal analysis

The analyses of both the heat sink and the spotlight dealt with heat transfer in a steady state, based on the assumption that enough time has passed for heat flow to stabilize. Analysis of a steady-state heat transfer is independent of the time it took for the heat flow to reach that steady state, which in practice may take seconds, hours, or days.

An analysis of heat flow changing with time is called transient thermal analysis, as for example, the analysis of a coffee pot kept hot by a heating plate. The temperature of the heating plate is controlled by a thermostat reading the temperature of the coffee. The thermostat turns the power on if the temperature of the coffee drops below a minimum temperature, and turns it off when the temperature exceeds a maximum, preset value. Temperature oscillations over a specified period of time are shown in Figure 19.

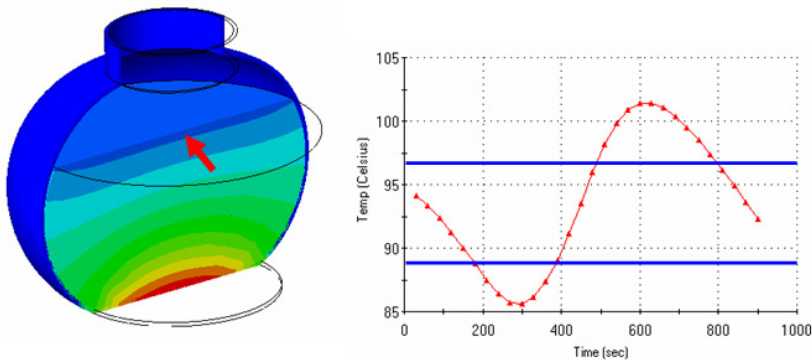

Figure 19: The connecting rod is presented to FEA as a structure so that stresses can be calculated.

## Thermal stresses

Heat flowing through a solid body will cause a change in temperatures in this body. Consequently the body will expand or shrink. Stresses caused by this expansion or shrinkage are called thermal stresses.

Thermal stresses occur in a mug when hot coffee is poured into it. A thermal analysis of such stresses requires identifying the temperature distribution; on the inside faces of the mug, the temperature is that of the hot coffee, while on the outside faces user-defined convection coefficients control heat loss to the surrounding air. Since cooling is a relatively slow process, a steady-state thermal analysis is applied to calculate the resultant temperature distribution in the coffee mug. The temperature distribution is non-uniform, causing thermal stresses that can easily be calculated in SolidWorks software by running a static analysis using the temperature results from the thermal analysis (Figure 20).

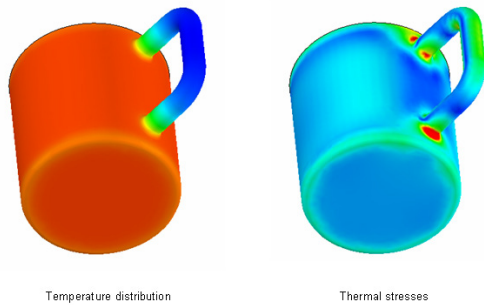

Figure 20: Nonuniform temperature field, found by steady-state thermal analysis (left), induces thermal stresses calculated in a structural static analysis (right).

## Desired capabilities of thermal design validation software

Considering the typical problems briefly introduced here, thermal analysis design validation software used in a product-design process must be able to model:

- Heat flow by conduction
- Heat flow by convection
- Heat flow by radiation
- The effect of a thermal resistance layer
- Time-dependent thermal effects such as heating or cooling (transient thermal analyses)
- Temperature-dependent material properties, heat power, convection coefficients, and other boundary conditions

There are also other requirements that a validation program used as a design tool should satisfy that are not only specific to thermal analysis, but, apply to structural or electromagnetic analyses. Since new products are universally designed on CAD, the efficient use of any type of validation software as a design tool also places the following requirements on CAD software:

The CAD system should be:

- A feature-based, parametric, fully associative solid-modeler
- Able to create all geometry, both manufacturing specific and analysis specific
- Able to move between design and analysis representations of the model while keeping geometries linked

The above requirements call for an advanced simulation system which combines ease of use with high computational power, such as the DS SolidWorks simulation program integrated with SolidWorks CAD software (a leading 3D parametric, feature-based CAD system).

State-of-the-art integration allows users to run thermal and structural analyses using the same familiar SolidWorks software interface, thus minimizing the need to learn analysis-specific tasks and menus (Figure 21).

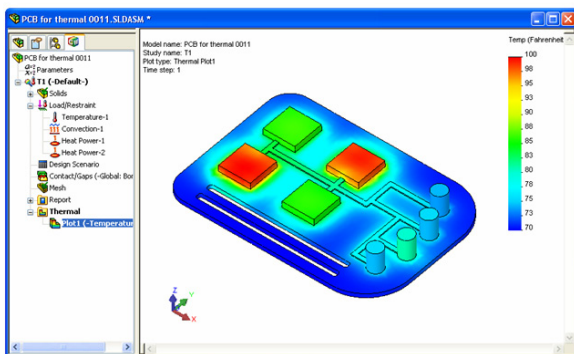

Figure 21: Analysis such as thermal analysis of a circuit board is conducted using the familiar SolidWorks software interface, minimizing the need for user training.

## Design problems that can be solved with SolidWorks software

The following sections present some examples of design problems solved using the thermal and structural analysis capabilities of SolidWorks software.

### Sizing the cooling fins of a heat sink

A microchip radiator must be designed to provide enough cooling to keep the microchip below 400 K. The microchip sits on a base plate. Because of the thermal resistance layer separating the plate from the rest of the assembly, the base plate provides only negligible cooling.

Running a thermal analysis on the initial design with a cooling-fin height of 20 millimeters shows a temperature of 461 K (Figure 22, top). Changing the cooling fins to 40 millimeters high increases the cooling, but not enough to meet the specification; the microchip temperature is now 419 K (Figure 22). A third iteration with 60 millimeters-high fins proves successful, as the microchip temperature is now 400 K, an acceptable value (Figure 22).

Convection coefficients, which are an important consideration in this study, can be found in engineering textbooks or can be calculated using web-based calculators. Alternatively, a study of fluid flow around the radiator may be conducted using SolidWorks Flow Simulation to determine these values.

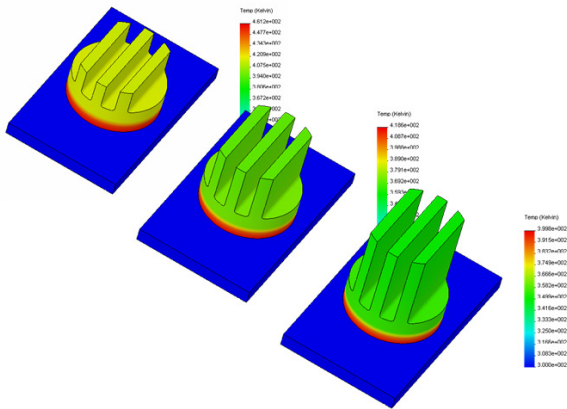

Figure 22: Heat sink with three design configurations.

## Designing a heating element

A heating element consists of an aluminum plate with an embedded heating coil. The m-shaped coil design shown in Figure 23 is preferred for its low cost. However, thermal analysis proves that it generates a nonuniform temperature on the outside of the plate as shown in Figure 23.

A redesigned heating plate features the heating element forming a spiral as shown in Figure 24. Repeating the thermal analyses on the modified design demonstrates that the distribution of temperature is now almost uniform (Figure 24).

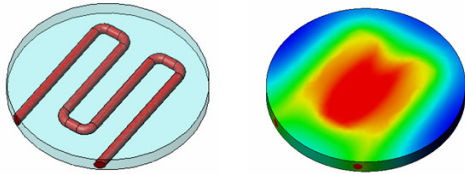

Figure 23: A simple design of a heating element embedded in an aluminum plate

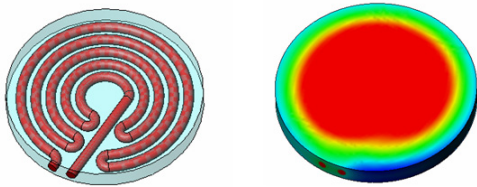

Figure 24: A redesigned heating plate is shown with uniform distribution of temperatures.

## Finding thermal stresses in a spotlight housing

A spotlight (Figure 17) is rigidly supported along the circumference as shown in Figure 25. The housing develops thermal stresses because it cannot freely expand while its temperature increases.

Finding thermal stresses requires a combination of thermal and structural analyses, where temperature results (Figure 25) are exported to a static analysis in order to calculate thermal stresses. Design validation is needed to examine whether the thermal stresses exceed the yield strength of the aluminum housing. The stress plot in Figure 25 shows in red those areas of the housing where stress does indeed exceed the yield strength. These stress results prove that the housing as designed will yield.

Note that thermal stresses develop not because the temperature of the housing is nonuniform but because the restraint prevents the housing from expanding freely. Also, note that these stresses develop in the absence of any structural loads.

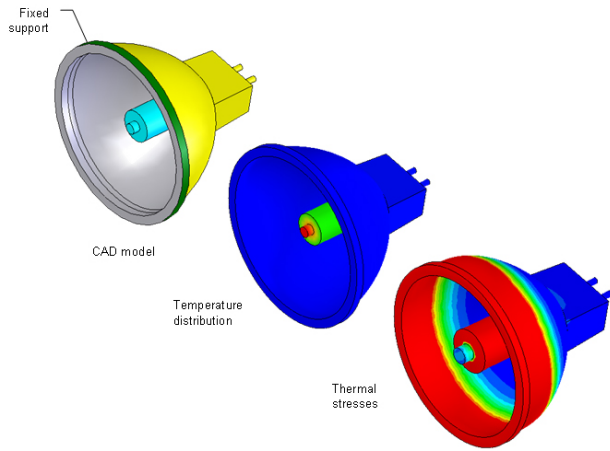

Figure 25: A spotlight is supported as shown in the top picture. The middle picture presents steady-state temperature distribution, and the bottom one shows in red where stresses exceed the yield strength.

### Finding thermal stresses in a flexible pipe

Suppose that a corrugated pipe, while free to deform, is subjected to different temperatures at its two ends. This results in the temperature field shown in Figure 26. The question of interest is whether it will develop any thermal stresses due to these differences.

Using the temperature results in a static analysis, the software calculates the pure effect of nonuniform temperature in the absence of any structural loads or supports. Figure 26 shows in red where the stress exceeds the pipe material's yield strength.

If desired, a structural load (Figure 27) may be applied to the pipe to calculate the combined effect of thermal and structural stresses.

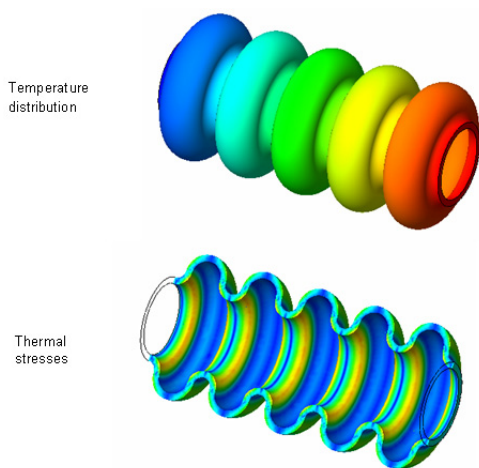

Figure 26: Due to a nonuniform temperature field, the pipe develops thermal stresses exceeding the yield strength of the pipe material.



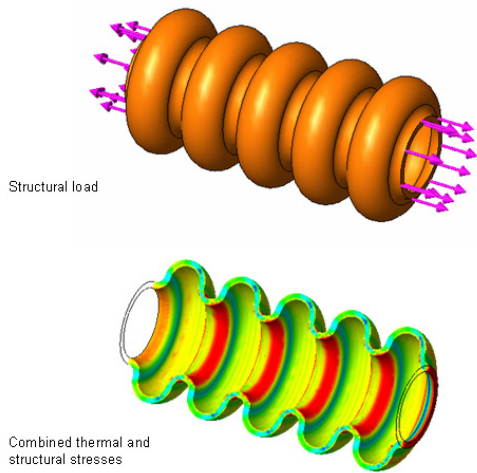

Figure 27: A corrugated aluminum pipe subjected to a tensile load (top) as well as thermal stresses, develops combined structural and thermal stresses (bottom).

### Overheating protection of an electronic circuit board

The preferred temperature of an electronic circuit board shown in Figure 28 is 700 °C and should not exceed 1200 °C. To prevent it from overheating, a controller cuts off the power when the temperature of the microchip exceeds 1200 °C. It turns the power back on when the temperature drops below 700 °C. However, because of thermal inertia, the temperature of the microchip may still exceed 1200 °C.

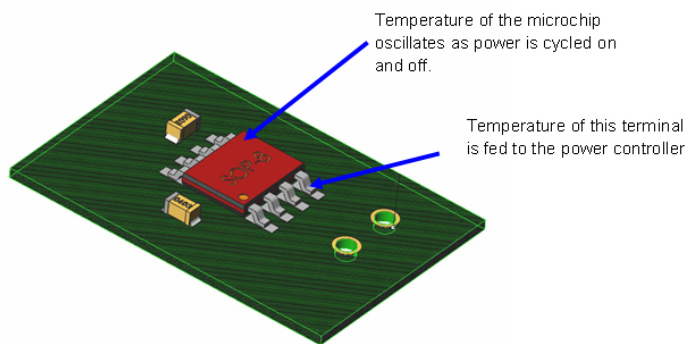

Figure 28: An electronic circuit board is protected from overheating by a controller.

Investigating the range of temperature fluctuations involves conducting a transient thermal analysis with the heat power controlled by a thermostat feature. This is similar to the coffee pot example in Figure 19. Having defined the material properties, convection coefficients, initial temperature, and heat power, the analysis is run for a period of 300 seconds. Fluctuations in microchip temperature are shown in Figure 29.

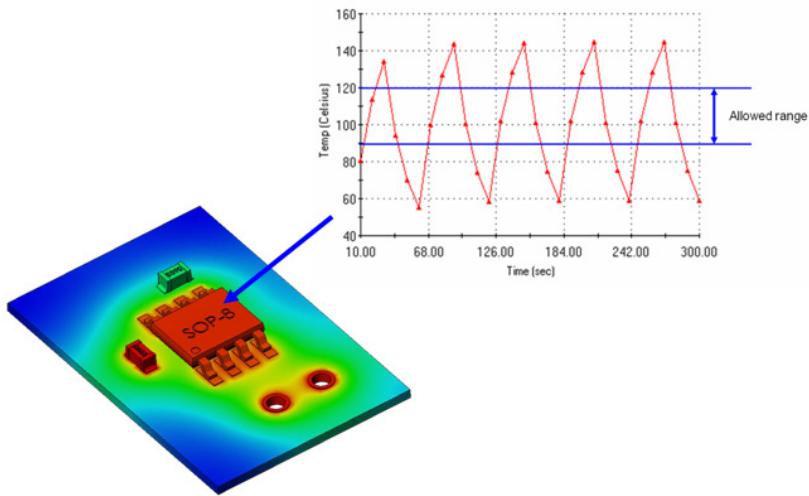

Figure 29: Temperature of the micro chip fluctuates as power is cycled on and off. Because of thermal inertia, the value exceeds the maximum allowed, 1200 °C.

The results of the transient thermal analysis clearly indicate that the controller power cut-off temperature must be lowered below 1200 °C to compensate for the thermal inertia of the system. The desired setting could be easily found in the next two to three iterations.

### Deformation analysis of a composite bearing-housing

A composite bearing-housing is subjected to an elevated temperature due to friction in the bearings. It is also subjected to bearing reaction loads. The challenge is to find the deformation of the bores where the bearings sit (Figure 30, top), to make sure that the bearings will not loosen the retaining press fit. This requires a combination of steady-state thermal and static analyses. The first step is to find the temperature across the bearing housing (Figure 30, bottom).

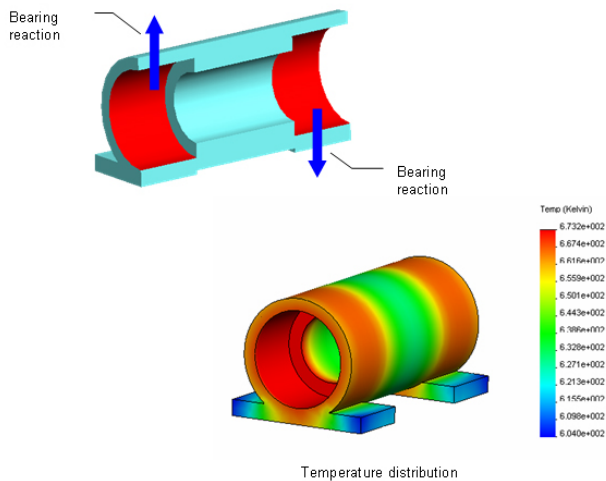

Figure 30: Bearing housing (top) is subjected to nonuniform temperature field due to heat generated in the bearings (bottom).

Based on these results, a static analysis is performed to calculate the deformation caused by the combined effect of thermal deformations and structural load. Figure 31 shows the radial displacement components of both bores.

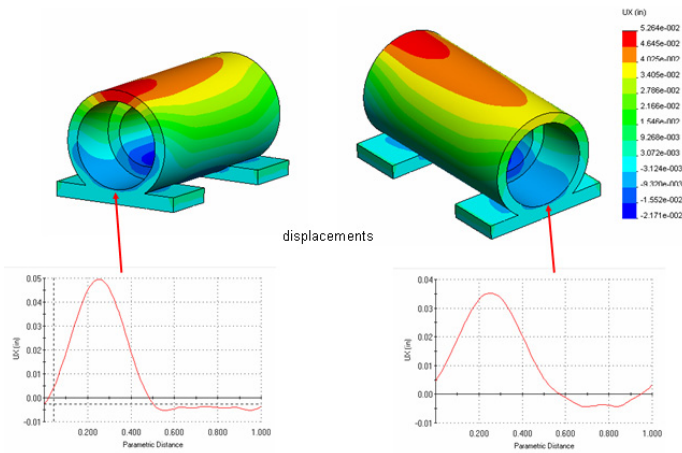

Figure 31: Radial displacement components of deformation of the bearing housing edges

## Conclusion

You should analyze anything that runs on electricity for thermal performance to avoid potentially dangerous overheating.

Thermal analysis design validation software used in the product-design process must be able to model heat flow by conduction, convection, and radiation. It must also model the effect of a thermal resistance layer, time-dependent thermal effects such as heating or cooling, temperature-dependent material properties, heat power, convection coefficients, and other boundary conditions.

Since new products are universally designed in CAD, any validation software used as a design tool must be a feature-based, parametric, fully associative solid-modeler that can create all geometry and move between design and analysis representations of the model while keeping geometries linked.

SolidWorks Simulation offers all the above requirements in an advanced simulation system which combines ease of use with high computational power.

Dassault Systèmes  
SolidWorks Corp.  
300 Baker Avenue  
Concord, MA 01742 USA  
Phone: 1 800 693 9000  
Outside the US: +1 978 371 5011  
Email: [info@solidworks.com](mailto:info@solidworks.com)  
[www.solidworks.com](http://www.solidworks.com)

