

ROOT CAUSE ANALYSIS OF FIVE COSTLY CENTRIFUGAL PUMP FAILURES

by

Heinz P. Bloch

Consulting Engineer

Process Machinery Consulting

Montgomery, Texas



Heinz P. Bloch is a licensed Consulting Engineer with offices in Baytown, Texas. His company is Process Machinery Consulting Company. He retired from Exxon in 1986, after 24 years of service. His professional career included a long term assignment as Exxon Chemical Company's Regional Machinery Specialist for the United States. He also held machinery oriented staff and line positions with Exxon affiliates in the United States, Italy, Spain, England, The Netherlands, and Japan. Troubleshooting and reliability improvement missions have taken him to affiliated companies and machinery manufacturing plants in more than a dozen additional locations worldwide. He has conducted public and/or inplant courses in the United States, Canada, Kuwait, Indonesia, Pakistan, Surinam, Venezuela, and other countries.

The depth of Mr. Bloch's involvement in all aspects of machinery reliability improvement is indicated in over 50 technical society papers and publications. His seven comprehensive books on practical machinery management and maintenance cost reduction have been used for lectures and consulting assignments worldwide. In addition, Mr. Bloch holds four United States patents relating to high speed machinery improvements.

Mr. Bloch graduated from the New Jersey Institute of Technology with B.S. and M.S. degrees in Mechanical Engineering. He was elected to three national honor societies, and is a member of ASME and STLE, and the Vibration Institute and is a Registered Professional Engineer in the States of Texas and New Jersey.

ABSTRACT

Machinery failure analysis and troubleshooting are often pursued in a somewhat haphazard, unstructured fashion. This paper presents a novel, proven, and well focused approach which can quickly lead to the root cause identification of virtually any component distress. This repeatable method is based on the premise that components fail only if they are subjected to undue force, a reactive environment, time-based exposure, or extreme temperature. However, while these failure mechanisms will tell how and why a failure mode such as brittle fracture, melting, etc., might have occurred in chemical or metallurgical terms, failure mechanisms do *not* define the root cause of failure.

Using five illustrative examples, it is shown how through a process of elimination failure analysis can rapidly define which of *only seven possible root causes of machinery failures*, design deficiency, materials defect, processing and manufacturing deficiency, assembly error, off design or unintended service condition, maintenance deficiency, or improper operation holds the key to a particular failure event.

INTRODUCTION

After a few years of operation, the overwhelming majority of centrifugal pumps in service today will have experienced repeat failures. Most of these are premature, or unexpected. Equipment distress events due to component wearout, or end-of-life failures are quite rare. Repeat failures, often of the same pump component, occur because the owner or user has either not uncovered, or perhaps elected not to remedy, the root cause of the problem.

Root cause analysis is aimed at uncovering the sometimes elusive failure sequence—and thus, root cause—of the events leading up to equipment failure. It recognizes that *all* failures, without exception, belong to one or more of *only seven* categories:

- Faulty design
- Material defects
- Fabrication or processing errors
- Assembly or installation defects
- Off design or unintended service conditions
- Maintenance deficiencies (neglect, procedures), and finally,
- Improper operation.

Root cause analysis further recognizes that without exception, the basic agents of machinery component and part failure mechanisms are *always* force, time, temperature, or a reactive environment. One or more of these mechanisms may combine and hasten component degradation [1]. Contributing or interacting factors are all part of a system; consequently, the entire system must be subject to review and scrutiny.

Using the above premises, a straight forward approach can be introduced which has assisted the author in identifying the root causes of many costly failures involving centrifugal pumps in process and utility services. Five such failures are examined in greater detail:

- Repeat bearing failures which were attributed to vendor *design* error.
- Several bearing failures, and finally a potentially damaging fire, caused by incorrect prelubrication of thrust bearings during shop *assembly*.
- Extreme vibration and deterioration of grease-lubricated sleeve bearings in large seawater intake pumps traceable to *operations* error.
- Repeated and costly thrust bearing failures in a mining slurry pump caused by mistakes in parts documentation, *fabrication and procession*.
- Loss of life in a U.S. Gulf Coast plant, possibly caused by simple *maintenance* oversight.

CHECKLIST APPROACHES GENERALLY AVAILABLE

It would be difficult to think of machinery troubleshooting tasks that would not benefit from a structured approach. Time is saved, accuracy improved and the risk of encountering repeat failures is reduced whenever the troubleshooter makes use of a

comprehensive checklist such as the one compiled by Karassik, Tables 1 and 2 [2]. An internationally recognized authority on pumps and their application, Karassik believes that, while no list of pump troubles can ever be complete, it make sense to use checklists in diagnosing centrifugal pump troubles. The checklist approach shown in Tables 1 and 2 correlates observed symptoms with possible causes of trouble. Of course, checklists could be further expanded by observing the symptoms of bearing distress with corresponding possible causes, or mechanical seal distress could be tabulated together with possible contributing causes. Similarly, vibration symptoms could be contrasted with causes, or stuffing box packing deterioration diagnosed from a symptom *vs* cause comparison matrix.

Table 1. Check Chart for Centrifugal Pump Problems.

Symptoms*	Possible cause of trouble* (Each number is defined in Table 2)
1. Pump does not deliver liquid	1, 2, 3, 5, 10, 12, 13, 14, 16, 21, 22, 25, 30, 32, 38, 40
2. Insufficient capacity delivered	2, 3, 4, 5, 6, 7, 7a, 10, 11, 12, 13, 14, 15, 16, 17, 18, 21, 22, 23, 24, 25, 31, 32, 40, 41, 44, 63, 64
3. Insufficient pressure developed	4, 6, 7, 7a, 10, 11, 12, 13, 14, 15, 16, 18, 21, 22, 23, 24, 25, 34, 39, 40, 41, 44, 63, 64
4. Pump loses prime after starting	2, 4, 6, 7, 7a, 8, 9, 10, 11
5. Pump requires excessive power	20, 22, 23, 24, 26, 32, 33, 34, 35, 39, 40, 41, 44, 45, 61, 69, 70, 71
6. Pump vibrates or is noisy at all flows	2, 16, 37, 43, 44, 45, 46, 47, 48, 49, 50, 51, 52, 53, 54, 55, 56, 57, 58, 59, 60, 61, 67, 78, 79, 80, 81, 82, 83, 84, 85
7. Pump vibrates or is noisy at low flows	2, 3, 17, 19, 27, 28, 29, 35, 38, 77
8. Pump vibrates or is noisy at high flows	2, 3, 10, 11, 12, 13, 14, 15, 16, 17, 18, 33, 34, 41
9. Shaft oscillates axially	17, 18, 19, 27, 29, 35, 38
10. Impeller vanes are eroded on visible side	3, 12, 13, 14, 15, 17, 41
11. Impeller vanes are eroded on invisible side	12, 17, 19, 29
12. Impeller vanes are eroded at discharge near center	37
13. Impeller vanes are eroded at discharge near shrouds or at shroud/vane fillets	27, 29
14. Impeller shrouds bowed out or fractured	27, 29
15. Pump overheats and siezes	1, 3, 12, 28, 29, 38, 42, 43, 45, 50, 51, 52, 53, 54, 55, 57, 58, 59, 60, 61, 62, 77, 78, 82
16. Internal parts are corroded prematurely	66
17. Internal clearances wear too rapidly	3, 28, 29, 45, 50, 51, 52, 53, 54, 55, 57, 59, 61, 62, 66, 77
18. Axially-split casing is cut through wire-drawing	63, 64, 65
19. Internal stationary joints are cut through wire-drawing	53, 63, 64, 65
20. Packed box leaks excessively or packing has short life	8, 9, 45, 54, 55, 57, 68, 69, 70, 71, 72, 73, 74
21. Packed box: sleeve scored	8, 9
22. Mechanical seal leaks excessively	45, 54, 55, 57, 58, 62, 75, 76
23. Mechanical seal: damaged faces, sleeve, bellows	45, 54, 55, 57, 58, 62, 75, 76
24. Bearings have short life	3, 29, 41, 42, 45, 50, 51, 54, 55, 58, 77, 78, 79, 80, 81, 82, 83, 84, 85
25. Coupling fails	45, 50, 51, 54, 67

Table 2. Possible Causes of Trouble.

Suction Troubles
1. Pump not primed
2. Pump suction pipe not completely filled with liquid
3. Insufficient available NPSH
4. Excessive amount of air or gas in liquid
5. Air pocket in suction line
6. Air leaks into suction line

7. Air leaks into pump through stuffing boxes or through mechanical seal
- 7a. Air in source of sealing liquid
8. Water seal pipe plugged
9. Seal cage improperly mounted in stuffing box
10. Inlet of suction pipe insufficiently submerged
11. Vortex formation at suction
12. Pump operated with closed or partially closed suction valve
13. Clogged suction strainer
14. Obstruction in suction line
15. Excessive friction losses in suction line
16. Clogged impeller
17. Suction elbow in plane parallel to the shaft (for double-suction pumps)
18. Two elbows in suction piping at 90° to each other, creating swirl and prerotation
19. Selection of pump with too high a Suction Specific Speed

Other Hydraulic Problems

20. Speed of pump too high
21. Speed of pump too low
22. Wrong direction of rotation
23. Reverse mounting of double-suction impeller
24. Uncalibrated instruments
25. Impeller diameter smaller than specified
26. Impeller diameter larger than specified
27. Impeller selection with abnormally high head coefficient
28. Running the pump against a closed discharge valve without opening a by-pass
29. Operating pump below recommended minimum flow
30. Static head higher than shut-off head
31. Friction losses in discharge higher than calculated
32. Total head of system higher than design of pump
33. Total head of system lower than design of pump
34. Running pump at too high a flow (for low specific speed pumps)
35. Running pump at too low a flow (for high specific speed pumps)
36. Leak of stuck check valve
37. Too close a gap between impeller vanes and volute tongue or diffuser vanes
38. Parallel operation of pumps unsuitable for the purpose
39. Specific gravity of liquid differs from design conditions
40. Viscosity of liquid differs from design conditions
41. Excessive wear at internal running clearances
42. Obstruction in balancing device leak-off line
43. Transients at suction source (imbalance between pressure at surface of liquid and vapor pressure at suction flange)

Mechanical Troubles—general

44. Foreign matter in impellers
45. Misalignment
46. Foundation insufficiently rigid
47. Loose foundation bolts
48. Loose pump or motor bolts
49. Inadequate grouting of baseplate
50. Excessive piping forces and moments on pump nozzles
51. Improperly mounted expansion joints
52. Starting the pump without proper warm-up
53. Mounting surfaces of internal fits (at wearing rings, impellers, shaft sleeves, shaft nuts, bearing housings, etc.) not perpendicular to shaft axis
54. Bent shaft
55. Rotor out of balance
56. Parts loose on the shaft
57. Shaft running off-center because of worn bearings
58. Pump running at or near critical speed
59. Too long a shaft span or too small a shaft diameter
60. Resonance between operating speed and natural frequency of foundation, baseplate or piping
61. Rotating part rubbing on stationary part
62. Incursion of hard solid particles into running clearances
63. Improper casing gasket material
64. Inadequate installation of gasket
65. Inadequate tightening of casing bolts
66. Pump materials not suitable for liquid handled
67. Certain couplings lack lubrication

Mechanical Troubles—sealing area

68. Shaft or shaft sleeves worn or scored at packing
69. Incorrect type of packing for operating conditions
70. Packing improperly installed
71. Gland too tight, prevents flow of liquid to lubricate packing
72. Excessive clearance at bottom of stuffing box allows packing to be forced into pump interior
73. Dirt or grit in sealing liquid
74. Failure to provide adequate cooling liquid to water-cooled stuffing boxes
75. Incorrect type of mechanical seal for prevailing conditions
76. Mechanical seal improperly installed

Mechanical Troubles—bearings

77. Excessive radial thrust in single-volute pumps
78. Excessive axial thrust caused by excessive wear at internal clearances or by failure or, if used, excessive wear of balancing device
79. Wrong grade of grease or oil
80. Excessive grease or oil in anti-friction bearing housings
81. Lack of lubrication
82. Improper installation of anti-friction bearings such as damage during installation, incorrect assembly of stacked bearings, use of unmatched bearings as a pair, etc.
83. Dirt getting into bearings
84. Moisture contaminating lubricant
85. Excessive cooling of water-cooled bearings

FAILURE STATISTICS CAN BE HELPFUL

Another highlighted approach [1] attempts to give a statistical indication of the most frequently encountered centrifugal pump troubles (Table 3). The numbers listed in columns A through H indicate the probability ranking of the various causes which could result in a particular symptom manifesting itself.

Table 3. Troubleshooting Guide for Centrifugal Process Pumps.

	Symptoms								Symptoms							
	D Insufficient Disch. Pressure				Short Bearing Life				E							
	C Intermittent Operation				Short Mech. Seal Life				F							
	B Insufficient Capacity				Vibration and Noise				G							
A No Liquid Delivery				Power Demand Excessive				H								
Possible Causes	#	A	B	C	D	E	F	G	H	#	Possible Remedies					
Suction Problems	Pump Is Cavitating (Symptom For Liquid Vaporizing In Suction System)	1	2	1	1		9	1	1		* Check NPSHa/NPSHr Margin * If Pump Is Above Liquid Level, Raise Liquid Level Closer To Pump * If Liquid Is Above Pump, Increase Liquid Level Elevation					
	Insufficient Immersion Of Suction Pipe Or Bell (Vert. Turbine P.)	2	1	1	1		1	2			* Lower Suction Pipe Or Raise Sump Level * Increase System Resistance					
	Pump Not Primed	3	1	2					3		* Fill Pump & Suction Piping Complete With Liquid * Eliminate High Points In Suction * Remove All Non-Condensibles (Air From Pump, Piping And Valves) * Eliminate High Points In Suction Piping * Check For Faulty Foot Valve Or Check Valve					
Hydraulic System	Non-Condensibles In Liquid	4	2	3	1				4		* Check For Gas/Air Ingress Through Suction System/Piping * Install Gas Separation Chamber					
	Supply Tank Empty	5	3						5		* Refill Supply Tank					
	Obstructions In Lines Or Pump Housing	6	9	7			7	6			* Inspect And Clear					
Possible Causes	#	A	B	C	D	E	F	G	H	#	Possible Remedies					

	Symptoms								Symptoms							
	D Insufficient Disch. Pressure				Short Bearing Life				E							
	C Intermittent Operation				Short Mech. Seal Life				F							
	B Insufficient Capacity				Vibration and Noise				G							
A No Liquid Delivery				Power Demand Excessive				H								
Possible Causes	#	A	B	C	D	E	F	G	H	#	Possible Remedies					
Mechanical System	Speed Too High	16							1	16	* Check Motor Voltage—Slow Down Driver					
	Speed Too Low	17	4	4		2				17	* Consult Driver Troubleshooting Guide					
	Wrong Direction Of Rotation	18	5			3			6	18	* Check Rotation With Arrow On Casing—Reverse Polarity On Motor					
	Impeller Installed Backward (Double Suction Imp.)	19		10					12	19	* Inspect					
	Misalignment	20						1	2	4	7	20	* Check Angular And Parallel Alignment Between Pump & Driver			
	Casing Distorted From Excessive Pipe Strain	21					2	3	5		21	* Check For Misalignment * Check Pump For Wear Between Casing And Rotating Elements * Analyze Piping Loads				
	Inadequate Grouting Of Base	22							6		22	* Check Grouting & Regrout If Required				
	Bent Shaft	23						3	4	7	8	23	* Check Deflection (Should Not Exceed 0.002"). Replace Shaft & Bearings If Necessary			
	Internal Wear	24							8		9	24	* Check Impeller Clearances			
	Mechanical Defects Worn, Rusted, Defective Bearings	25							5	8	10	25	* Inspect Parts For Defects—Repair Or Replace. Use Bearing Failure Analysis Guide * Check Lubrication Procedures			
Mechanical System	Unbalance—Driver	26					5	7	9		26	* Run Driver Disconnected From Pump Unit—Perform Vibration Analysis				
	Unbalance—Pump	27					4	6	3		27	* Investigate Natural Frequency				
	Motor Troubles	28						6	8	10	11	28	* Consult Motor Troubleshooting Guide			
Possible Causes	#	A	B	C	D	E	F	G	H	#	Possible Remedies					

	Symptoms								Symptoms							
	D Insufficient Disch. Pressure				Short Bearing Life				E							
	C Intermittent Operation				Short Mech. Seal Life				F							
	B Insufficient Capacity				Vibration and Noise				G							
A No Liquid Delivery				Power Demand Excessive				H								
Possible Causes	#	A	B	C	D	E	F	G	H	#	Possible Remedies					
Hydraulic System	Strainer Partially Clogged	7		3						7	* Inspect and Clean					
	Pump Impeller Clogged	8	8	8					5	8	* Check For Damage And Clean					
	Suction ori/ & Dischrg. Valve(s) Closed	9	9							9	* Shut Downs & Open Valves					
	Viscosity Too High	10		7			5			4	10	* Heat Up Liquid To Reduce Viscosity * Increase Size Of Discharge Piping To Reduce Pressure Loss * Use Larger Driver Or Change Type Of Pump * Slow Pump Down				
	Specific Gravity Too High	11								2	11	* Check Design Specific Gravity				
	Total System Head Lower Than Design Head Of Pump	12				4		11	3	12		* Increase System Resistance To Obtain Design Flow * Check Design Parameters Such As Impeller Size etc.				
Mechanical System	Total System Head Higher Than Design Head Of Pump	13	6	5	4			10	2	13	* Decrease System Resistance To Obtain Design Flow * Check Design Parameters Such As Impeller Size, etc.					
	Unsuitable Pumps In Parallel Operation	14	7	6		6				14	* Check Design Parameters					
	Improper Mechanical Seal	15							1	15	* Check Mechanical Seal Selection Strategy					
Possible Causes	#	A	B	C	D	E	F	G	H	#	Possible Remedies					

Thus, looking at Table 3 to determine the most probable cause for insufficient pressure generation (Symptom D) will determine that investigators should look for possible causes in this sequence:

- Noncondensibles (air) in liquid
- Pump speed too low
- Wrong direction of rotation
- Total system head lower than design head of pump—pump is “running out”
- Viscosity too high
- Two or more pumps in parallel operation but having unsuitable head vs flow characteristics
- Internal wear, i.e., wear ring clearances, excessive.

However, while the use of checklists and/or probability rankings is strongly recommended, the person engaged in pump failure analysis may do well to remember that all problems can be assigned to one or more of the seven cause categories mentioned earlier. In addition, the troubleshooter should keep in mind the basic agents of machinery component and part failure mechanisms, i.e., force, time, temperature, and a reactive environment.

It is doubtful whether statistics have been compiled to show the overall distribution of failures as they relate to the seven cause categories given in the INTRODUCTION. At best, the reviewer might expect to find failure cause and failure mode distributions for critical components [1] or entire machine categories such as centrifugal pumps [3] and gears [1]. The latter

reference subdivides gear failure causes into vendor problems (36 percent), operating problems (47 percent), and extraneous influences (17 percent). It is interesting to note that unpublished statistics from a large petrochemical plant tend to show problem distributions for several machine categories to be in the same overall range.

SYSTEMATIC APPROACHES ALWAYS VALUABLE

Considerable involvement with pump maintenance and repair would lead us to estimate a failure cause distribution for centrifugal pumps in U.S. process plants as given in Table 4. This failure analysis and troubleshooting approach attempts to focus on this estimated cause distribution. In other words, an approach which seeks to first find the root causes of failures in the categories with the highest probability ranking might be generally endorsed. This approach does not, however, overlook the need to:

- Start at the beginning by:
 - reviewing the pump cross-section drawing.
 - “thinking through” how the individual parts function or malfunction.
 - understanding the process loop and process operations.
- Take a systems approach. Never lose sight of the fact that:
 - the pump is only part of the overall loop.
 - the part that failed is very often not the root cause of the problem and unless we find the root cause, repeat failures are likely to occur.
- Collect all the pieces. The missing part may contain clues which must be examined and which may have had an influence on failure cause or failure progression.
- Use a calculation approach while not, or course, neglecting the intuitive or prior experience-utilization approach.

With this in mind, the first of the five pump problems can now be examined.

Table 4. Failure Cause Distribution Estimate For Centrifugal Pumps In US Process Plants.

	% Incidence	Probability Ranking
Maintenance Deficiencies (Neglect, Procedures)	30%	1
Assembly Or Installation Defects	25%	2
Off-Design Or Unintended Service Conditions	15%	3
Improper Operation	12%	4
Fabrication Or Processing Errors	8%	5
Faulty Design	6%	6
Material Defects	4%	7

FAULTY DESIGN CAUSES PREMATURE BEARING FAILURES

Not too long ago, a 125 hp, 3560 rpm, 310 gpm, 670 ft head single-stage overhung impeller centrifugal pump in hydrocarbon service experienced frequent bearing failures. With “Faulty Design” ranking next to last in the Failure Cause Distribution listing of Table 4, it was certainly not logical to immediately sus-

pect a fundamental design error or vendor-related engineering problem. Because of the probability ranking, maintenance-type causes were pursued first. Table 2 was consulted (items 77 through 85), and a supplementary 53-item bearing problem checklist [1] was used to ascertain that faulty assembly or maintenance could also be ruled out. Next, the failure analysis review focused on “Off-Design Conditions” and “Improper Operation.” When no problems were found in any of these areas, and it was further established that there were no material defects in the rolling element bearings, the investigation began to concentrate heavily on the possibility of a vendor error, i.e., “Faulty Design.”

Pump owner and pump manufacturer agreed to perform a field test on this failure-prone pump. A special test rig, Figure 1, was designed and fabricated by the pump manufacturer. It consisted of means to allow the pump rotor-bearing assembly to move in the axial (impeller thrust) direction. The total axial movement was limited so as not to exceed permissible impeller travel. Also, the axial thrust value was measured by three load cells (Figure 1), whose connecting cables are visible in the field test setup shown in Figure 2.

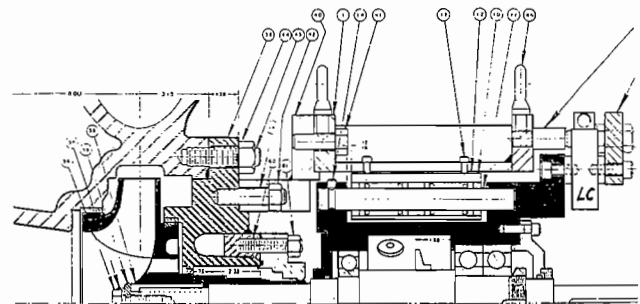

Figure 1. Design Drawing of Centrifugal Pump Axial Thrust Test Rig.

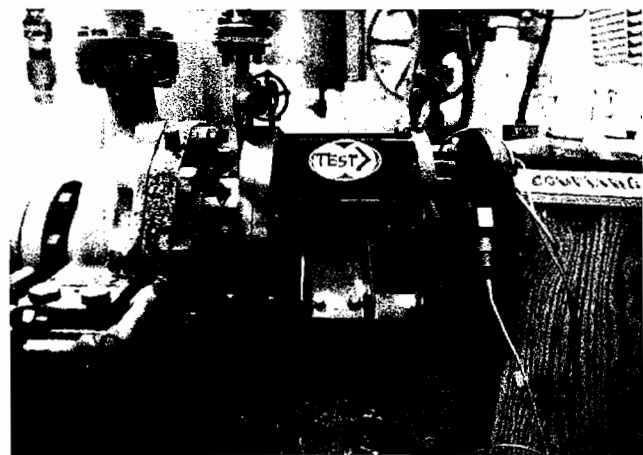

Figure 2. Field Installation of Special Bearing Housing Which Verified Centrifugal Pump Axial Thrust to be Excessive.

Test results were plotted and compared to the manufacturer's calculated and originally anticipated thrust values for this pump. As indicated in Figure 3, the experimentally verified thrust at shutoff was 2.6 times greater than anticipated. Since ball bearing life varies as the cube of the load changes, the life of the pump bearing would thus be reduced by a factor of 17.

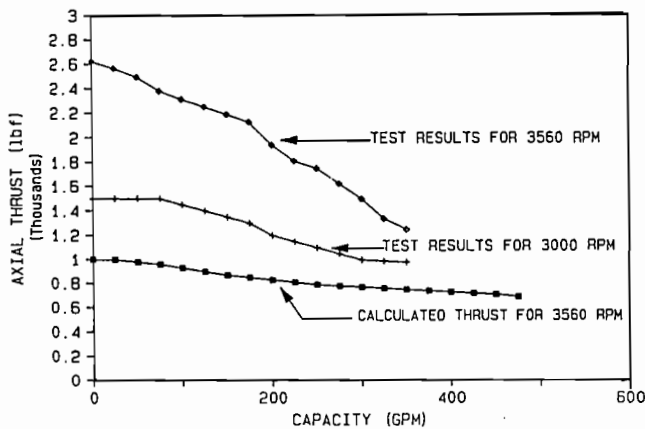

Figure 3. Experimentally Verified (Actual) Rotor Thrust Exceeds Manufacturer's Anticipated Values by a Factor of 2.6.

The test results convinced both the operating company and the pump manufacturer that the pump internals had to be redesigned to limit hydraulically induced thrust values to more reasonable limits. Obviously, the basic agent of the bearing failure mechanism was excessive force.

ASSEMBLY PROCEDURES MUST BE JUST RIGHT

How a seemingly minor assembly oversight or procedural shortcut can have a disproportionate impact on equipment performance and plant safety is illustrated in the next example.

During a two week period, several process pumps in a large ethylene plant developed problems soon after they had been returned to the field after having undergone seal and bearing replacements. A fire resulted when a 250 hp, 3560 rpm tar pump failed within eight hours after one such repair.

The pump in Figure 4 is identified as one of the MP-17 A or B sets feeding 320 gpm of tar at temperatures around 500°F from the primary fractionator tar boot and coke filter MF-2, through tar coolers and on to downstream process equipment. Pump design inlet and discharge pressure conditions were 10 psig and 300 psig, respectively.

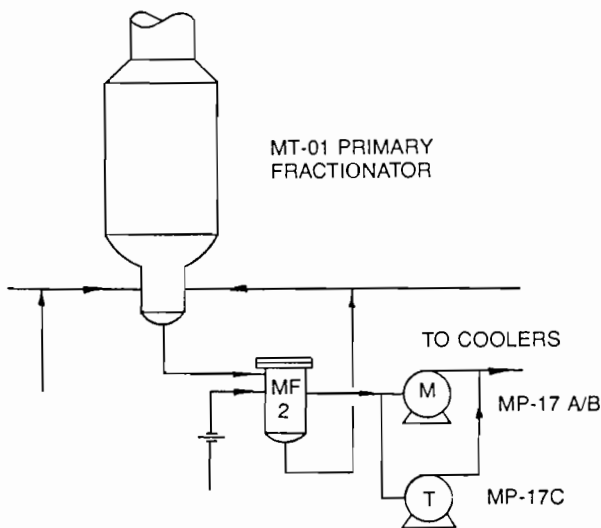

Figure 4. Flow Schematic Showing Tar Pump (MP-17A) Involved in Fire Event.

Because the failed MP-17A and its two companion pumps had previously given satisfactory service, it was decided initially not to pursue "Faulty Design" as the most probable cause. Similarly, "Fabrication or Processing Errors" were judged somewhat unlikely on rolling element bearings failing in succession. However, since the MP-17 pumps operate in hot service and take suction from a reactor with a varying liquid level, operations-related causes were reviewed with control room personnel. Process technicians reported that levels, flows, and pressures had been quite normal until the actual failure event. With adequate NPSH critically important to the safe, cavitation-free operation of centrifugal pumps, the availability of a strip chart recorder tape showing sufficient level in the suction vessel was considered a particular advantage.

Satisfactory operation is graphically represented in Figure 5, the strip chart obtained from the trend recorder for fractionator boot and main vessel level. At 17:30, or 5:30 p.m., the chart shows the boot level to be 100 percent. About 10 minutes later, the boot level was reduced to 35 percent for approximately 5 to 10 minutes before finally returning to 100 percent. The chart verifies that the boot level never dropped below 35 percent on the day of the failure incident. Therefore, pump operation errors or off-design service conditions did not seem at fault and were ruled out.

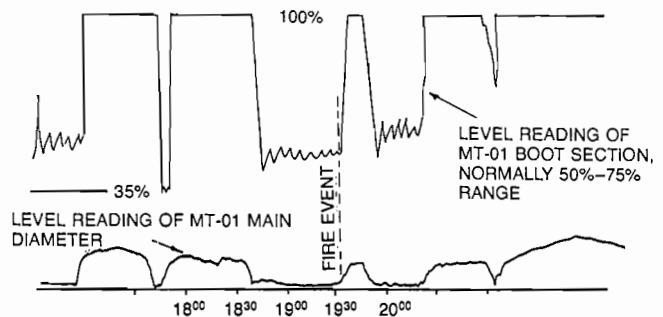

Figure 5. Strip Chart Showing That Adequate Liquid Level Existed in Suction Drum at all Times.

The failure analysis and troubleshooting effort now shifted to the areas "Maintenance Deficiencies" and "Assembly or Installation Defects." Debriefing the shop and field mechanical work forces shed some light on maintenance techniques and assembly quality-control procedures employed during repairs, which preceded the final failure event.

During a period of three days, the pump had been removed from its field location and taken to the shop three times for seal repairs, bearing replacement, and adjustments of one type or another. After a final overhaul, the pump was started up around 4:30 p.m. It was reported on fire at 7:30 p.m.

When the pump was dismantled, the seal area was found in clean and undamaged condition. Some solids were found in the impeller. Impeller wear rings and inboard bearing appeared satisfactory. The duplex thrust (outboard) bearings were totally destroyed. Severe metal loss was noted on virtually every bearing ball. Many balls were deeply embedded in the inner race; the ball separators had disintegrated. The shaft was severely bent in the region adjacent to the duplex bearing lock nut (Figure 6). Two of the four seal gland nuts had loosened, a third one had fallen off completely. A pedestal support bracket at point A had not been connected to the pump casing. The ductile iron bearing bracket was fractured at point B.

It was then theorized that failure of the duplex thrust (outboard) bearing set in motion the chain of events leading to the

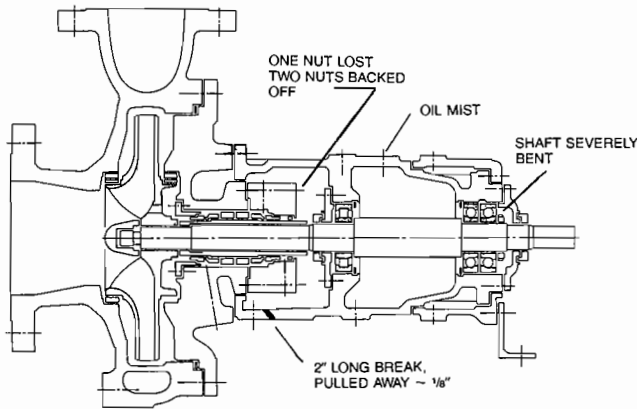

Figure 6. Schematic Cross-Sectional View of Centrifugal Pump.

fire. Excessive friction resulting from severe and near-instantaneous bearing failure could have caused the shaft to bend. Extreme vibration was certain to be generated and could have caused the less-than-optimally installed seal to release pumpage. By this time, the outboard bearing area was thought to have been red hot, causing spilled pumpage to ignite.

It was noted that near-instantaneous massive failure of rolling contact bearings is most frequently caused by deficient lubrication and overheating. The failure was too massive and too far progressed to allow determination of the origin of overheating. Installation method, housing bore dimensions, shaft dimensions, driver to pump alignment accuracy, class of bearing (i.e., rolling element tolerance) and sparking action between auxiliary gland and shaft sleeve could have played a role in the event. However, the primary cause of bearing overheating upon initial operation of new bearings at this plant was not related to any of the above. Instead, the most probable cause was the practice of prelubricating with a penetrating oil which was never meant to be applied in this manner. Its extreme low viscosity (75 SUS @ 100°F) makes it suitable only for bicycle and door lock type of lubrication duties. This oil was found very volatile and would evaporate at temperatures well below those anticipated for new antifriction bearings operating at relatively high speeds.

The chart in Figure 7 was used to determine the viscosity required to adequately lubricate the MP-17 bearings. At a mean diameter of 87.5 mm and a speed of 3570 rpm, a minimum lubricant viscosity of 8.3 cSt is required. As shown in Figure 8, maintaining this minimum viscosity is possible only if operating temperatures do not exceed 130°F. Newly installed duplex and double row thrust bearings will, however, experience temperatures well in excess of 130°F. Although a superior grade oil mist lubricant was supplied to these particular pump bearings, the mist lube could not overcome the diluting effect of the inferior low viscosity oil which was present in a "trough" formed by the bearing outer race at the six o'clock position. The existence of this "trough," or minisump explains why oil mist lubricated bearings in horizontally arranged pumps and drivers generally survive for periods of eight or more hours after the oil mist supply has been turned off. Unfortunately, if the minisump is filled with a dilutant, the beneficial effects of applying highly viscous lubricants cannot come into play until the damage is done.

In conclusion, prelubrication with an inadequate lubricant was proven to be the root cause of this and other serious pump failures which had preceded this particular event. Had the reviewer allowed himself to be distracted by additional but, in the final analysis, minor deviations such as the out-of-perpendicularity of seal faces, defective sleeve gasket, and a missing support brack-

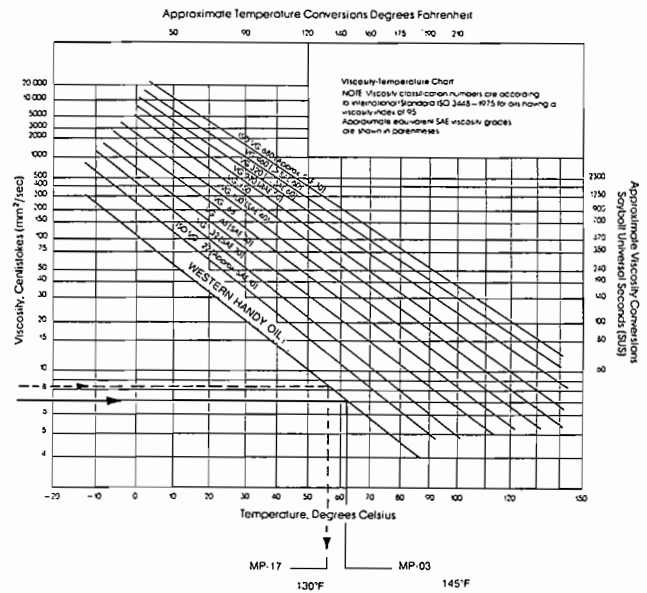

Figure 7. Temperature-Viscosity Chart Illustrates that Excessively Low Viscosity Lubricants Will Not Support Oil Film at Temperatures Typically Encountered by Process Pumps.

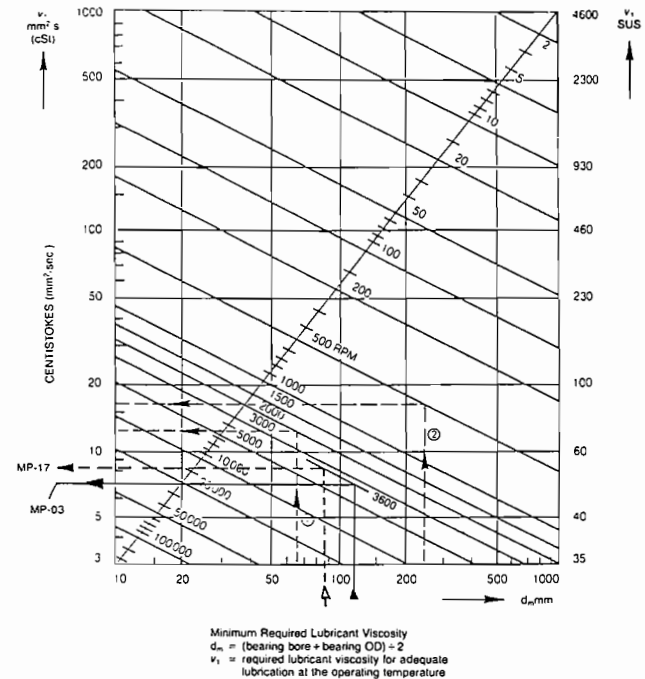

Figure 8. Oil Viscosity Requirements Plotted vs Mean Bearing Diameter and Shaft Speed.

et, the true root cause might not have been uncovered until much later.

By way of recap, the root causes of this particular failure event were uncovered by first looking at the entire system. Next, the review proceeded to examining all pieces, and playing through a typical "what if" scenario ultimately provided the needed focus:

- Failures after two hour run length of MP-17A on brand new bearings, and two and eight hour runs of another pump on brand

new bearings in the same general span of four or five work days were thought to follow a pattern pointing to possible commonality of failure causes. The common link in all failures was pre-lubrication with a lubricant approaching the characteristics of penetrating oils.

- Extreme unbalance vibration originating at the impeller, due to possible coke plugging, would have been expected to cause wear ring and inboard bearing defects. These possible events were thus ruled out as quite improbable.
- Seal failure preceding bearing failure was inconsistent with the surprisingly clean appearance of the seal after the fire.
- Sparking action due to rubbing contact between a non-standard auxiliary gland (made of 316 SS) and seal sleeve (made of 410 SS) was considered possible but should have resulted in severe galling of the softer of the two materials. No such galling was observed.
- Tar leakage between shaft and sleeve had probably occurred, but was not thought to have started the fire. Experience shows that pump fires brought on by seal distress must reach a very high intensity before outboard thrust bearings disintegrate catastrophically. A low level fire lasting for five to 10 minutes simply did not fit this scenario.

It should be noted that plotting the temperature-viscosity relationship of this penetrating oil on an ASTM chart (Figure 8) could be considered the equivalent of analytical calculations. Calculations are very often superior to conjecture and guesswork when attempting to find the root causes of pump failures.

As to the basic agent of this bearing failure mechanism, it was quite obviously temperature. Pre-lubrication with a much more viscous oil was initiated and there have not been any similar failures since.

FABRICATION AND PROCESSING ERRORS CAN PROVE COSTLY

There is an interesting story behind a long series of randomly occurring thrust bearing failures in one particular type of slurry pump in service at a South American bauxite mine. Apparently the thrust bearings would sometimes fail after a few days or, at other times, after a few weeks of operation. Before the mechanics produced a cross-sectional view similar to the simplified version depicted in Figure 9, the author had been told that it was often necessary to rebush and line bore the bearing housing. The relevance, accuracy, or importance of this verbal failure description becomes evident only when the drawing is examined in detail.

With the impeller inverted so as to reduce the differential pressure across the shaft packing area, it is immediately shown that the primary thrust is from right to left. The two angular contact bearings on the extreme left are correctly oriented to take

up the predominant load. However, the outer rings are completely unsupported, because the fabricator had somehow decided to overbore the housing in the vicinity of these two bearings. Consequently, the entire radial load acting on the coupling end of the pump had to be absorbed by the remaining third angular contact thrust bearing. This bearing was thus overloaded to the point of rapid failure and was, of course, prone to rotate in the housing. Using a double row spherical roller bearing at the hydraulic end of the pump would normally make for a sturdy, well designed pump. In this case, however, the spherical rotation or compliance feature tended to further increase the radial load transferred to the one remaining outboard bearing. The basic agent of the component failure mechanism was, of course, force.

An equally serious burden was imposed on this pump by the well intentioned person who, in an effort to link the spare parts requirements of the North and South American plants of this major aluminum producer, added to the drawing the parts list partially reproduced under Figure 9. Having left off the appropriate alpha-numeric coding behind the bearing identification number the bearing identification number 7312, this plant and its sister facilities would receive thrust bearings in other than matched sets. A quick look at the bearing manufacturer's dimension tables (second insert, Figure 9) shows simple type 7312 bearings to have a width which may differ from the next bearing by as much as 0.006 in. Mounting two such bearings in tandem may cause one to carry 50 to 100 percent of the load, while the other one would simultaneously carry 50 to 0 percent load. On the other hand, matched sets intended for tandem mounting would be precision-ground for equal load sharing and would be furnished with code letter suffixes to indicate this design intent.

Did the author go through the seven cause categories to identify the above root causes? Frankly, no. When both the fabrication sketch and the procurement documentation — "information processing" — show two very obvious errors, it is reasonable that rectification of these deviations should be a prerequisite to further fine-tuning. This is just another way of saying that if it looks like a duck, walks like a duck, and quacks like a duck, we ought to call it a duck and dispense with further research into the ancestry of the bird.

OPERATIONS ERRORS CAN CAUSE FREQUENT BEARING FAILURES

The next problem involved four 2500 hp vertical pumps in seawater service. Operating at 595 rpm, these 14000 m³/hr (60000 gpm), 44 m (135 ft) head pumps experienced high shaft vibration and extreme wear of the grease-lubricated bottom bearings. The plant operators realized that high vibration occurred primarily during low flow operation or whenever additional parallel-operating pumps were started up. An outside consultant recommended that the automatic pressure-fed grease-lubricated bronze bearings of the four pumps be converted to continuous water lubrication at a cost of \$500,000. It would appear that this consultant made the typical mistake of concentrating only on an examination of the principal part that had failed, i.e., the bearing.

The analysis strategy consisted of a review of the vibration records, repair history, spare parts consumption, and physical examination of bearing and impeller wear patterns. Since the pumps had been designed and manufactured by an experienced company and were generally running quite well, the cause categories "Faulty Design," "Fabrication or Processing Errors," and "Assembly or Installation Defects" were not considered high on the list of probable failure initiators. There did not appear to be any material defects on either the badly worn bottom bearing or the slightly cavitation-eroded impeller vanes. Accordingly,

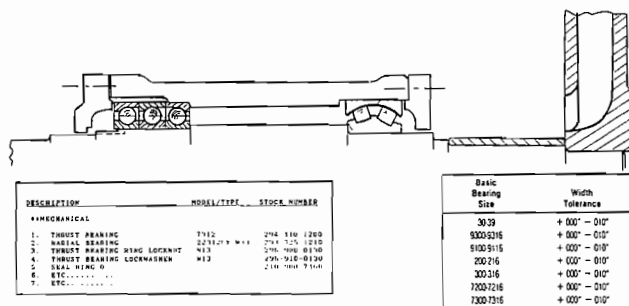

Figure 9. Bearing Housing Showing Ball Thrust Bearings Which Failed Frequently.

we concentrated on a review of the categories "Off-Design or Unintended Service Conditions," and "Improper Operation." The pump performance curve, Figure 10, rapidly furnished the answer.

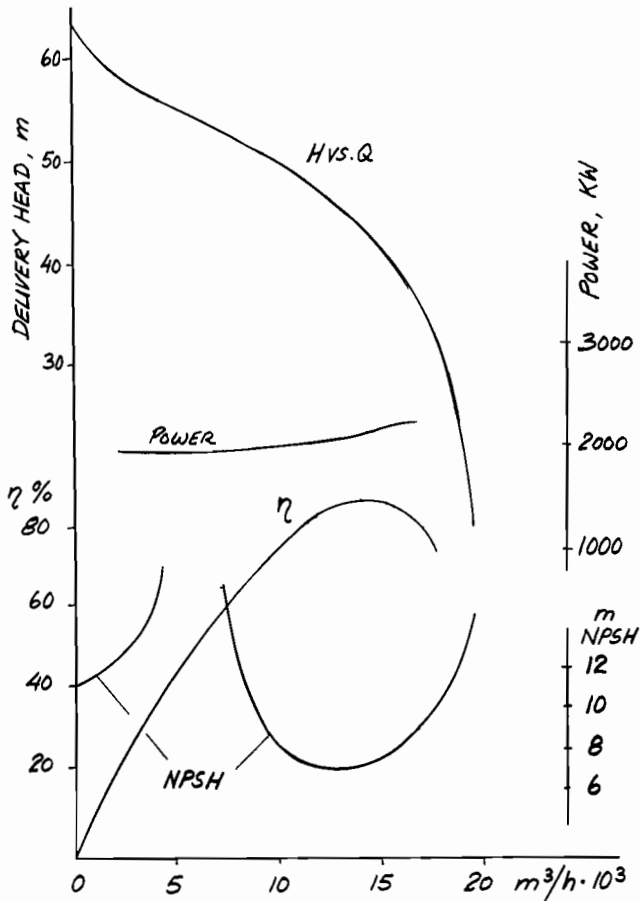

Figure 10. Performance Chart for Vertical Pumps in Seawater Intake Service. Note NPSH trace.

When operating at throughputs in the vicinity of 5,000 cubic meters per hour, the required NPSH (net positive suction head, largely a measure of inlet pressure) would be exceedingly high, certainly twice the NPSH required at 10,000 cubic meters per hour. With the available NPSH for each seawater intake pump essentially fixed at roughly 12 meters, reductions in throughput flow from the customary 8,000 cubic meters per hour per pump could rapidly drive the pump performance into the cavitation range where high vibration would be encountered. The equipment owner was advised to consider installing an automatically controlled low flow bypass loop or a combination of supervisory instrumentation and seawater consumer-to-pump-operator communication link (audio-visual electronic interface). This would give the utility crew sufficient time to always have only that number of pumps on line which would be needed by the downstream processes while at the same time satisfying the flow requirements of each individual vertical pump.

The principal cause category in this failure example was improper operation. The basic agent of the parts failure mechanisms was excessive force.

MAINTENANCE OMISSIONS CAN CAUSE LOSS OF LIFE

One of the more tragic pump failure incidents occurred at a hydrocarbon processing plant in the U.S. Gulf Coast area in 1982 (Figure 11). It involved the pump shown in the foreground of Figure 12.



Figure 11. Propane Pumps Involved in a Disastrous Flash Fire.

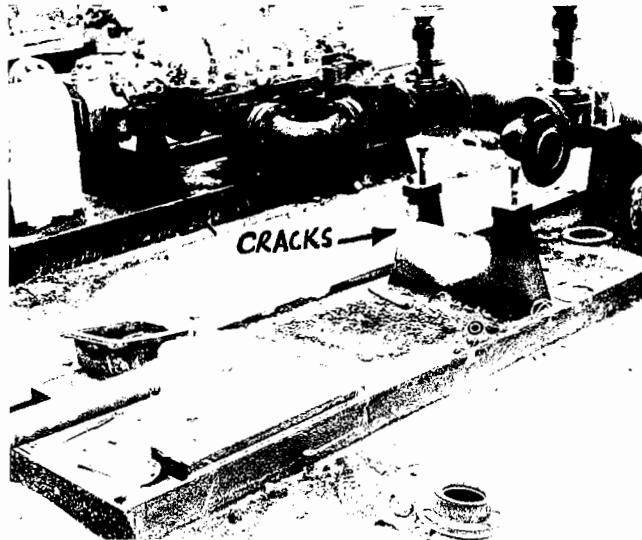

Figure 12. Broader View of Pumps in 1982 Hydrocarbon Processing Plant Accident.

When a pump malfunction was detected by control room personnel at this plant, two operators went to the area and realized from the dimensions of a propane vapor cloud that the pump had to be shut down. As they approached the equipment, the vapor ignited causing both men to suffer extreme burns. One of the two operators later died.

As is usual in such cases, an effort was later made by a local expert to reconstruct the event and determine the cause of the fire. His report noted that the mechanical seals had received flush liquid via API Plan 31, i.e., recirculation from the pump case through a cyclone separator delivering clean propane to the seal and, in his own words, certain amounts of entrained water to the pump suction. After examining the pump internals (Figure 13) the local expert determined,

that a failure of the pump occurred and that the dynamic forces distorted the pump in order to throw the rotating section between the two bearings out and away from the center line of the shaft, causing it to wear on exactly the same side throughout the length of the pump inside the casing.

It is the opinion of [the local expert] that a pump failure of this type with these results could not be anticipated by the operating personnel of [the owner's plant] and that there was no failure of adequacy of instruction to operating personnel at the plant. It is the further opinion of the [local expert] that the two leaks that were present and that ignited after the pump fire occurred were the type of leaks that are normal to the operation of a plant of this nature and that they, in and of themselves, are not indicative of any failure of either good engineering practices or proper maintenance.

Authorized by the owner, the local expert supervised the removal of seals, bearings, and impellers (Figures 14, 15, 16, and 17) in efforts to find a crack or cracks in the shaft material which, he reasoned, might have initiated the catastrophic failure of the pump.

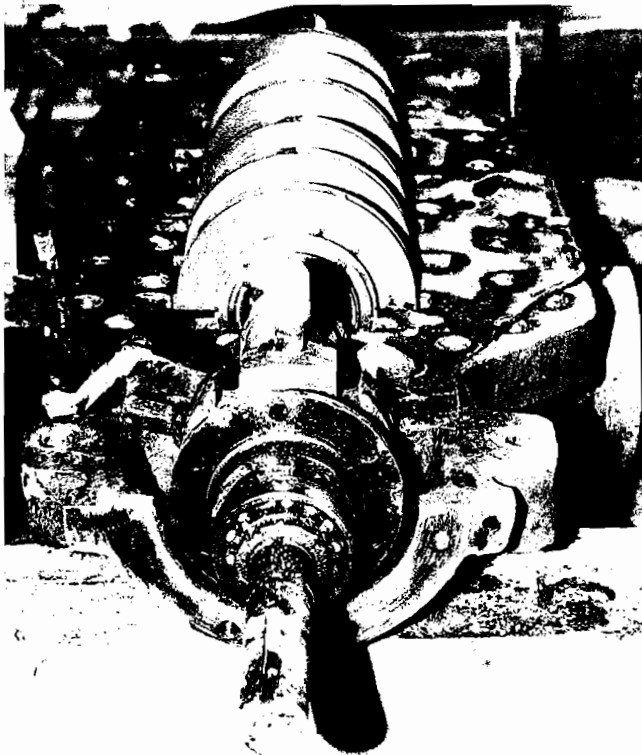

Figure 13. Pumps Internals Immediately After the Fire.

Together with five or six other equipment and component manufacturers, a repair shop which had worked on the pump four years prior to this incident had to defend itself in court. The attorney representing this pump repair shop engaged the author and requested reviews of depositions and photographs to prepare defense arguments.

Although the plaintiff's expert had already gone on record with the statement that pump failure originated with a crack somewhere in the pump shaft, our review effort was again aimed at eliminating at least some of the seven principal failure cause categories by assembling as much pertinent data as was possible

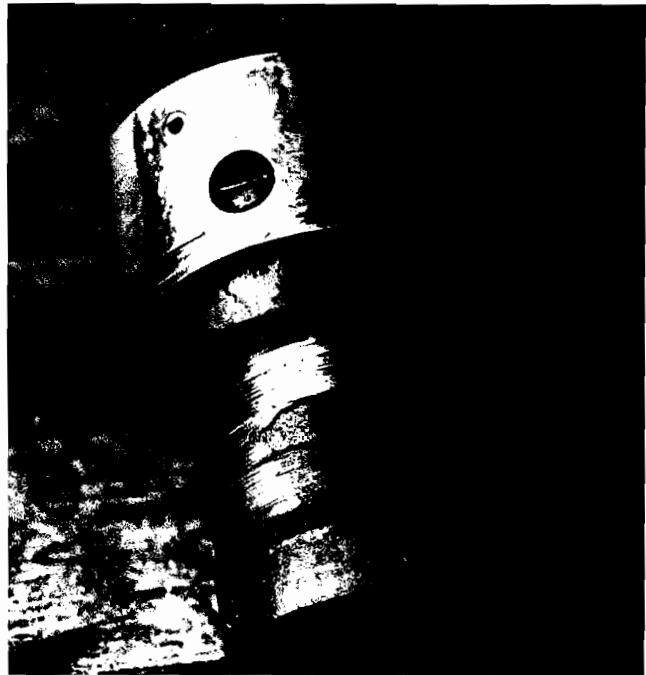

Figure 14. Mechanical Seal Assembly Showing Severe Rubbing.



Figure 15. Questionable Procedure for Removing Rolling Element Bearings (Pump Inboard Side).

at this late stage in the investigation. The category "Off Design or Unintended Service Conditions" was ruled out on the basis that similar pumps had been installed elsewhere and had operated well under similar conditions. "Improper Operation" did not appear likely since the unit was running normally and the pump in question was not in a startup or shutdown phase at the time of the incident. "Faulty Design" was not judged likely in view of the age and experience record of this pump model. "Fabrication or Processing Errors" and "Assembly or Installation Defects" were ranked somewhat more likely, and "Maintenance Deficiencies" and "Material Defects" tentatively, and somewhat arbitrarily, put at the top of the list.

Next, a site visit was arranged. As is appropriate when using a conscientious systems approach which includes a review of all relevant component parts, a box of broken parts was examined

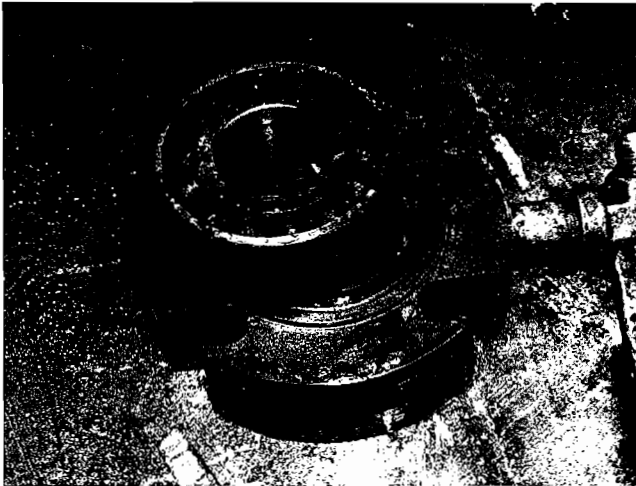

Figure 16. Double-Row Thrust Bearing Showing Adequate Lubrication at Time of Pump Failure.

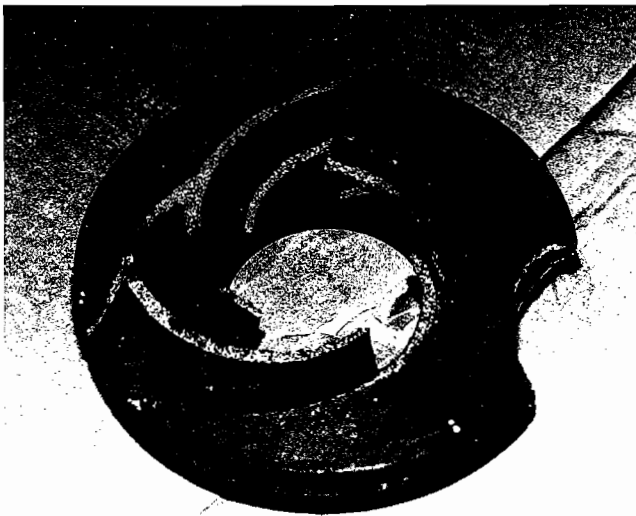

Figure 17. Impeller Destroyed at Disassembly.



Figure 18. More Components Destroyed at Disassembly.

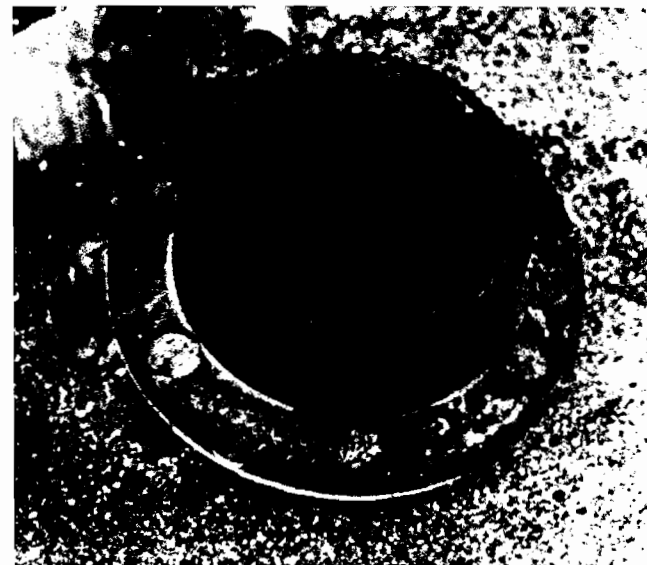

Figure 19. Worn Gear Coupling.

at the plant site (Figure 18), but no coupling components were found. Since a motor-to-pump coupling is, of course, part of the system, it was judged important to review its condition. Fortunately, the coupling was found on the ground in close proximity to the pump base (Figure 19) and serious wear was immediately evident (Figure 20). Other pertinent observations rapidly followed and led to a rather concise summary report of the most likely sequence of events at this facility. Note the "points of evidence:"

- A combination of misalignment and lack of lubrication in the gear coupling very probably led to excessive vibration.

Points of evidence: severe ridges were visible in the softer of the two mating gears; no traces of lubricant were found in the drive-side coupling on the failed pump set; also, no traces were found of lubricant in the couplings of both adjacent identical pump sets.

- High levels of vibration and severe misalignment probably caused crack propagation in each of the four pump support legs. It was noted that a similar crack had been repair-welded on one support leg of an adjacent identical pump.

- At this time, a combination of shaft misalignment and coupling inflexibility is thought to have caused amplified vibration which led to shaft bow and internal rubbing.

- Severe internal misalignment now caused the ball separator on the radial bearing (near drive end) to disintegrate (Figure 13).

- Vibration next caused fatigue failure of a pipe nipple connected to the cyclone separator (Figure 14). This caused a massive spill of pumpage and also deprived the mechanical seal of flush liquid.

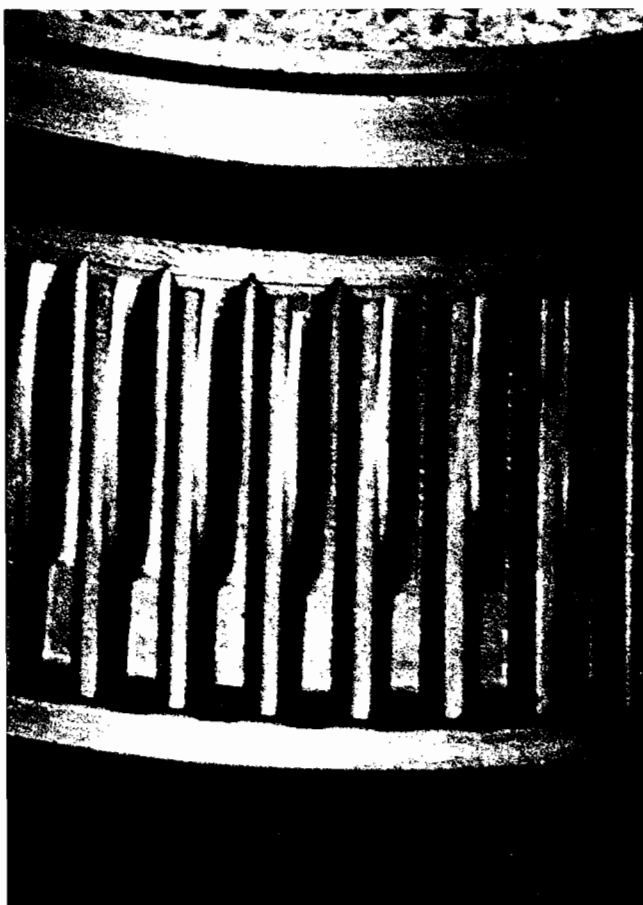

Figure 20. Closeup of Worn Gear Coupling.

- The bearing now reached a temperature of approximately 800°F; at about the same time, the mechanical seal faces began to heat-check and secondary leakage started to develop.

- Hydrocarbon vapors and/or liquids with an auto ignition temperature ranging between 450°F and 650°F ignited and a flash fire resulted.

Additionally, the author noted that the entire pump installation had to be considered vulnerable, due to the lack of thermal expansion capability of pump suction piping, lack of seal welding on pipe nipples filled with flammable liquid, and lack of coupling lubrication. Even visual observation allowed the observer to conclude that the shaft was bent. This bend was located near the hot bearing and followed the classic pattern observed by machinery engineers on the vast majority of pumps involved in this type of failure progression. Had the shaft been bent to begin with, this 3,600 rpm pump set would have exhibited abnormally high vibration from the time of commissioning. All internal parts rubs and also the cracking pattern on shaft sleeves were completely as anticipated in this particular event and were judged the consequence of the sequence indicated above.

A number of valuable lessons are contained in this story. First, very few failure events are the result of a single error or omis-

sion. What if the pump suction piping had been designed more flexibly and would not frequently have pushed the equipment out of alignment? What if someone would have seen to it that the relatively heavy cyclone separator had been braced or supported differently or, better yet, would have challenged its highly questionable usefulness in the first place? What if someone had decided that highly flexible nonlubricated or elastomeric couplings should be used on these pumps? Or, what if someone had simply greased the gear couplings twice a year? This certainly would have vastly reduced the probability the *time* emerging as the basic agent of the failure mechanism causing serious coupling distress.

And, finally, from a failure analysis and troubleshooting point of view, how much more quickly would the most probable failure sequence and its root causes have been uncovered if someone had used a more reasonable and well-structured failure analysis approach?

MAKING THE CASE FOR FAILURE PREVENTION AHEAD OF FAILURE ANALYSIS

It is worth noting that while pump problems and failure incidents can often be traced back to a given root cause or origin, catastrophic failures are rarely the result of only a single violation. Many times, a series of omissions, oversights, or errors combine and lead to the inevitable failure.

Pump users can do much to reduce the risk of experiencing equipment failures. Well thought-out specifications, drawing and document reviews, compliance with uncompromising installation procedures, operator and mechanical work force training, and a good combination of preventative and predictive maintenance (periodic condition monitoring) are just a few of the proven ways that come to mind.

When failures do occur, there is no substitute for applying properly focused and repeatable approaches to failure analysis and troubleshooting. The use of checklists is encouraged, as is the "systems approach," and collecting all the pieces before attempting to determine what happened.

The next step is for the failure analyst or machinery troubleshooter to remember the seven principal causes categories and to rank them in logical order. Using a process of elimination, the most probable cause categories, or perhaps the ones that are most easily and rapidly screened, are investigated first. The four basic agents of machinery component and part failure mechanisms also have to be kept in mind. The final and most important review will then almost naturally focus on the one area which contains the root cause of a failure event.

REFERENCES

1. Bloch, H. P., and Geitner, F. K.; *Machinery Failure Analysis and Troubleshooting*, Houston, Texas: Gulf Publishing Company (1983).
2. Karassik, I. J., "Centrifugal Pump Clinic," *Chemical Processing*, September 1988, pp. 122-128.
3. Bloch, H. P.; *Improving Machinery Reliability*, Revised 2nd Edition, Houston, Texas: Gulf Publishing Company (1988).