

2014

User Manual

NRSIGN 3840/ NRSIGN 5000Q

Nr Sign INC.

Nr Sign ©



Copyright

© 2009 Nr Sign INC. All rights reserved.



Nr Sign INC,

#202, 109 Braid street, New Westminster, BC, V3L5H4

Website: www.NrSign.com



Authorized Representative:

Preissler Medintechnik,

Address: Augsburg Strasse 75, Kaufbeuren, Germany, D-87600

Tel: ++ 49. 8341. 41425 Fax: ++ 49. 8341. 5451

This user manual is prepared in English and translation into any language, reproduction and copying of this document in whole or in part is not allowed except by written permission of NrSign Manufacturing.

Trademarks

NRSIGN INC

December 2009



Table of Content

Copyright.....	2
1. Identification.....	6
1.1. Classification.....	6
1.2. Using this User Manual	7
1.2.1. Convections	8
1.3. General Warnings.....	8
1.4. Environmental condition	13
1.5. Marking and symbols attached to the equipment.....	13
1.6. Guarantee specifications	14
1.6.1. Guarantee exclusions	14
1.6.2. Technical support information	15
1.6.3. Customer support information	15
2. System overview.....	16
2.1. General	16
2.1.1. NR SIGN 3840 EEG Routine	16
2.1.2. NRSIGN 5020 EEG Monitoring	17
2.2. Head box.....	19
2.3. Interface.....	20
2.4. Photic stimulator	20
2.5. Isolation power system	21
2.6. Digital Video recording device.....	21
2.7. Accessories	21
3. Preparing and starting system.....	24
3.1. Start-Up	24
3.2. Switching NRSIGN System on	25
3.3. Switching NRSIGN System off.....	25
3.4. NRSIGN view	25



3.4.1.1. Detail view of PC	Error! Bookmark not defined.
3.4.1.2. Detail view of interface	Error! Bookmark not defined.
3.4.1.3. Detail view of Photic stimulator	Error! Bookmark not defined.
3.4.1.4. Detail view of Video Camera	Error! Bookmark not defined.
3.4.1.5. Detail view of isolating transformer	Error! Bookmark not defined.
3.4.1.6. Detail view of head box - NR SIGN 3840 routine EEG	33
3.4.1.7. Detail view of head box - NR SIGN 5000Q EEG monitoring	35
3.5. System setting up	40
4. NRSIGN Software	48
4.1. NRSIGN Software Installation	49
4.2. NRSIGN Software upgrading	62
4.3. Software initialization	62
4.4. Starting the software	72
4.4.1. Define a new patient	72
4.4.2. Start a new record	73
4.4.3. Load a record	74
4.4.4. Close a record	75
4.4.5. Connect to extracted package	75
4.5. Exiting the software	76
5. Recording	76
5.1. Montage Editor	77
5.1.1. Create a new montage	78
5.1.1.1. Channel Rename	80
5.1.1.2. Channel define	83
5.1.1.3. Average Editor	88
5.1.1.4. Set New Reference	95
5.1.2. Modify selected montage	97
5.1.3. Remove selected montage	98
5.2. Scale setting	98
5.3. Filters	99

5.3.1. Notch Filter	100
5.3.2. Limiter	101
5.4. Photic.....	101
5.5. HV	102
6. Reviewing.....	103
6.1. Replay Mode.....	105
6.2. Montage Editor	106
6.3. Scale settings	106
6.4. Filters.....	106
6.5. Marks.....	108
6.5.1. Annotation mark	108
6.5.2. Selection mark	110
7. Report	111
7.1. Patients information	111
7.2. Marks.....	113
8. View	121
9. Quick guide for operating NRSIGN	122
10. Cleaning and maintenance activities	125
10.1. Cleaning	125
10.2. System maintenance activities	125
10.2.2. Windows updates	126
10.2.3. Repairs	126
11. Trouble shooting.....	126
12. Technical data	129
13. License	132

1. Identification

This user manual is prepared as guidance for using NRSIGN 3840 routine EEG and NRSIGN 500Q Long-Term EEG Monitoring manufactured by Nr Sign INC Company. EEG system is used for recording the electrical activity of different parts of brain for diagnostic purposes. Recorded signals shall be used and interpreted by a physician or any professional person who is experienced enough in judgment about recorded information. In this part the necessary information for identifying EEG system proposed by Nr Sign INC Company is explained:

Device name	Electroencephalograph (EEG)
Type	Routine EEG / EEG Monitoring
Model	NRSIGN 3840 routine EEG / NRSIGN 5000Q Long-Term EEG Monitoring
Manufacturer	Nr Sign INC 1294 Michigan Drive, Coquitlam, BC, Canada V3B6T8 TEL: +1-604-945-5302 WWW.NRSIGN.CA
Nr Sign Authorized Representative
Software version	This device can be operated with NRSIGN software version 0 & higher
UMDNS-code	Electroencephalograph: 11467

NRSIGN 3840/ NRSIGN 5020 are diagnostic devices used for performing diagnostic examinations in Neurology and can be used in Neurological Clinics, Neurological ICU (Infants-Adults), and Neurology departments.

1.1. Classification

NRSIGN 3840 & NRSIGN 5000Q are designed and manufactured in accordance with the standards listed below:

- IEC 60601-1 (2005) Medical Electrical Equipment-Part 1: General Requirements for basic safety and essential performance.
- IEC 60601-2-26 (2003) Medical Electrical Equipment Part 2: Particular Requirements for Safety– Specification for Electroencephalographs.
- IEC 60601-1-2 (2007) Medical Electrical Equipment-Part 1-2: General requirements for basic safety and essential performance -Collateral standard: Electromagnetic compatibility-Requirements and Tests.

Considering Medical Device Directive (MDD 93/42/EEC) and IEC 60601-1, NRSIGN is classified in a table below:

Criteria	Description
Class	Class IIa (MDD: Medical Device Directive- rule 10) Class II (The Canadian regulation SOR/98-282. Rule 10:
Type of protection against electric shock	Class I (according to IEC 60601-1) Due to the Class 1 isolating power supply, the power supply and equipment shall be in the radiance of 2 meter from the patient.
Degree of protection against electric shock	BF applied part
Mode of operation	Continuous
Degree of protection against ingress of water	IPX0
	Note: <i>This device is not suitable to be used in presence of a flammable anesthetic mixture with air or with oxygen or nitrous oxide.</i>

1.2. Using this User Manual



Note: *This user manual contains necessary information for safe, correct and proper use of NRSIGN 3840 & NRSIGN 5020, so please read this manual carefully prior to system usage. Also, keep this manual available so that it would be possible to refer to it at any time.*

This user manual shall be read by anyone who aimed to work with routine EEG and EEG Monitoring devices manufactured by NrSign INC. This manual describes step-by-step the required information for installation, operation, and basic servicing activities. The chapters of this manual are structured as follows:

Chapter1. Identification of NRSIGN 3840 & NRSIGN 5000Q

Chapter2. System Overview

Chapter3. Preparing and starting system

Chapter4. NRSIGN Software

Chapter5. Recording

Chapter6. Reviewing

Chapter7. Report

Chapter8. View

Chapter9. Quick guide for operating NRSIGN 3840 & NRSIGN 5020

Chapter10. Cleaning and Maintenance activities

Chapter11. Trouble shooting

Chapter12. Technical data

Chapter13. License





Note: *This manual is only written in English and Nr Sign INC. is not responsible for any translated version of this manual.*

1.2.1. Convections

This manual uses the following convections in order to highlight the text:

Style	Usage
Bold	Menu names and commands, and window titles, buttons and options/ For emphasizing the important information in this user manual
Italics	Description of Warnings and notes

Symbols

Symbol	Description
	This symbol in this user manual indicates the important Notes and Warnings which requires more attention to avoid any injury or system misuse or even loosing necessary data.
	This symbol in this user manual is used for emphasizing the important information which shall be considered by user.

1.3. General Warnings

There is no side effect for user during the EEG test because the electrodes do not transfer any voltage or to the patient and users. And patients can be relaxed during the test

Please read the following cautions and warnings prior to system usage:

Cautions and warnings

Installation:

- After receiving the device, if it has any defected part do not install or operate it, just inform Nr Sign INC or its authorized representative for returning the product.
- After receiving the device it shall be prepared and installed according to the user manual.

Guarantee:

- Nr Sign will guarantee all its products for 1 year, **only if**, all servicing activities are performed by Nr Sign INC or its authorized representative.

- Nr Sign will guarantee all its products for 1 year. But, relevant service activities under guarantee do not offer by Nr Sign if any problem resulted from one of the following items happens:
 - o Any system misuse or abuse by customer
 - o Any damage resulted from ignoring the instructions available in User Manual (e.g. installation site conditions, environmental conditions...)
 - o Loss or sudden change of electrical power
 - o Unauthorized repairs or modification
 - o Any problem or damage resulted during shipment transport
- Customer is responsible to consult Nr Sign experts before changing system installation place; otherwise, company will not be responsible for providing relevant guarantee items which are affected by such movement.
- If user provides system trolley, the trolley should have four lockable wheels to avoid unwanted movement of equipment.
- Interfacing box must have a proper place to put in the trolley if user provides trolley.

System operation:

- After turning on the system, all power indicators on the system shall be turned on. Otherwise, check all connections and on/off switches. If the problem does not solve please notice Nr Sign Servicing Department or our authorized representative.

Servicing activities:

- In case of occurrence of any failure in system function, please inform Nr Sign or its authorized representative as soon as possible for further actions.
- If there is any problem, an error message will be appeared. Please turn off the system one time, if the error is not disappeared please notice Nr Sign or its authorized representative.
- Do not send back your device without any consultation with Nr Sign INC or its authorized representative.
- Do not try to fix or repair the device independently or by any other person except Nr Sign service personnel or its authorized representative; otherwise, Nr Sign won't be responsible for any resulted consequences. Moreover, if the device is still under guarantee Nr Sign won't be responsible for providing relevant guarantee items any more.

Electrical and electromagnetic safety warnings

- All different parts of the NRSIGN 3840 & NRSIGN 5000Q are supplied via isolating transformer to work safely.
- No equipment or device rather than NRSIGN device is allowed to be connected to isolating transformer.
- The input power cable of isolated transformer used as protective earth conductor (refer to page 46 on this manual), so
The earthing system of installation site (hospital/clinic/...) must be appropriate and standard and also in accordance with user manual description. Since the product is transportable, it is highly recommended that all building outlets have individual earth wire.
- NRSIGN 3840/ NRSIGN 5000Q must be connected to an outlet individually. Do not connect any other equipment or device to the same outlet which NRSIGN is connected to.
- The EEG device leakage current is 35 μ A, which can be increased up to 50 μ A. The risk of increasing the leakage current happens when different devices use the same earth. Each device shall have its own earthing system.
- To avoid summation of leakage current, do not use NRSIGN 3840/ NRSIGN 5000Q in combination with other active devices.
- Using NRSIGN 3840/ NRSIGN 5000Q and Defibrillator at the same time is not allowed, since they are not protected against the effect of defibrillation. If using defibrillator is necessary, disconnect patient from NRSIGN 3840/ NRSIGN 5000Q or at least turn it off.
- NRSIGN 3840/ NRSIGN 5000Q are not allowed to be used with high frequency (HF) surgical equipment, because it is not provided with protective means against burning of the patient.
- User is not allowed to touch inside parts of the system (or any conductive parts in patient environment) and patient simultaneously.
- Connecting to NRSIGN 3840/ NRSIGN 5000Q, patient is not allowed to touch the conductive parts of the equipment or other devices.
- Conductive parts of electrodes and their connectors should not contact other conductive parts including earth.



-DEVICE DOES NOT HAVE PROTECTION AGAINST HAZARDS OF IGNITION OF FLAMMABLE ANAESTHETIC MIXTURES

Frequency (MHz)	Limits	
	dB(μ V)	
	Quasi-Peak	Average
0.15 - 0.50	79	66
5.00 - 30.0	73	60

Note 1: The lower limit shall apply at the transition frequencies

Part 2 - Radiated Emissions Testing

DATE: April 27, 2011
 TEST STANDARD: CISPR11 & EN 55011
 TEST VOLTAGE: 120Vac/60Hz
 MINIMUM STANDARD: Group 1, Class A Limit at 10m:

Frequency (MHz)	Quasi Peak Limits dB(μ V/m)
30 to 230	40
230 to 1000	47

Note 1: the lower limit shall apply at the transition frequency
 Note 2: Additional provisions may be required for cases where interference occurs

Part 1 - Conducted Emissions Testing

DATE: April 27, 2011
 TEST STANDARD: FCC CFR47, Part 15, Subpart B
 TEST VOLTAGE: 120Vac/60Hz
 MINIMUM STANDARD: Class A Limit

Frequency (MHz)	Maximum Level (dB μ V)	
	Quasi-Peak	Average
0.15- 0.50	79	66
5.0 –30	60	50

- It is highly recommended to send back your system to Nr Sign for checking and calibration every 6 months or at least once in a year.

- This equipment has been tested and found to comply with the limits for a Class a digital device, pursuant to part 15 of the FCC Rules and ICES 03. These limits are designed to provide reasonable protection against harmful interference in a residential installation

Data Warnings

- Before using the acquired data make sure about the validity of the recorded signals, since NRSIGN 3840 & NRSIGN 5000Q do not check their validity.
- Do not install any other software on the computer since it may affect NRSIGN 3840 & NRSIGN 5000Q program.
- Read this user manual carefully before using NRSIGN software.
- Close down NRSIGN program before switching off the device.

Operational safety warnings

- Please connect all the channels on the head box via electrodes to the scalp of the patient; otherwise, the unconnected electrodes may become noisy and affect other channel signals some times.
- **EEG wires must be checked every 3 months by Multimeter according to below picture.**
- Power cables and electrode wires shall be checked continually. **Do not use the accessories which may be defected.**
- **Use accessories which NR SIGN INC provides you in system shipping package when receive your system.**
- During recording signals, patients shall be relaxed. Therefore, EEG system shall be used in a calm place. This is used in Professionals Neurologic Clinics, Medical Practice, and Neural Surgery.
- This device has no burning side effect.
- For ensuring about patient safety, only use Nr Sign accessories. Accessories shall be used according to hospital standards and Nr Sign instructions. Please pay attention to instructions offered by Nr Sign.
- Place EEG system where there is no risk of system falling on the patient or any other person.
- This system is not equipped with any alarm system.

This EEG devise should not be used simultaneous with HF surgical equipment. -

Interconnection of several EQUIPMENTS with EEG is not allowed -

The EQUIPMENT is not protected against cardiac defibrillator discharge -

The Equipment shall not be used simultaneously with defibrillator, this is declared in the -

- Do not open without manufacturer's uthorization -
- Only the service personel are authorized to service the device -

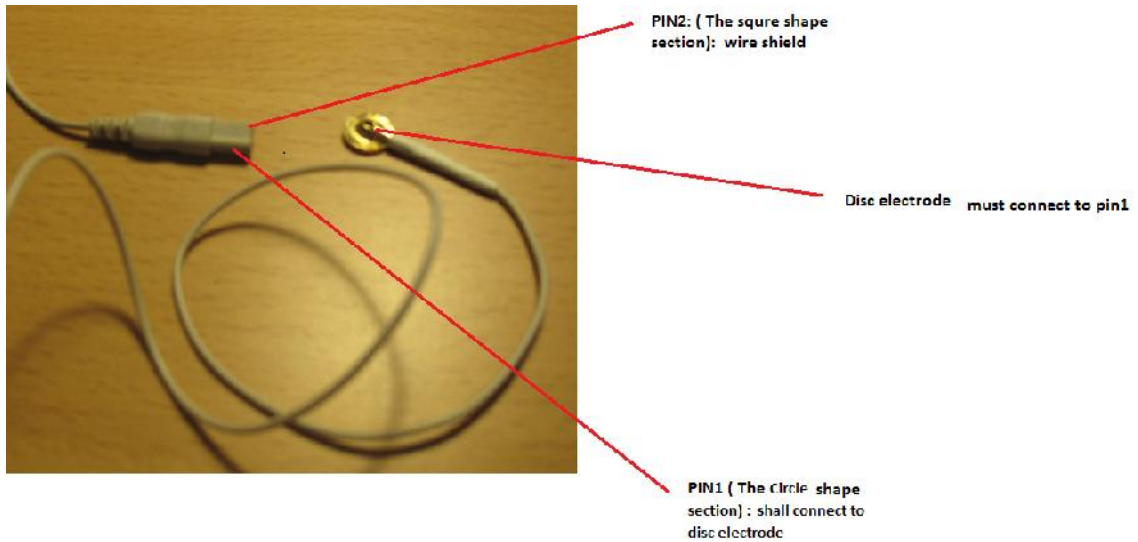



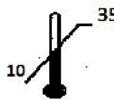



1.4. Environmental condition

-  **Temperature:** 10 - 35° C
- **Humidity:** 25% to 85% RH
- **Pressure:** 700mB – 1060 mB

1.5. Marking and symbols attached to the equipment

Attached markings and symbols to the equipment are listed in the table below:

Description	Symbol
Read User Manual	 or 
Power switch in on position	
Power switch in off position	

Type BF applied part	
Rated supply voltage range	110-220 VAC
AC symbol	
Rated supply frequency range	50-60 Hz
Product power	500 VA
Serial Number	
Amplifier serial number	AEHYYBBXX
Interface serial number	AEIYYBBXX
Photic stimulator serial number	AEPHYBBXX
Case serial number	AEPCYYBBXX
Note: In above serial number abbreviations have following meanings:	
AE: system version name.	H: Head Box part
YY: Year of production	I: Interface part
BB: Batch number	PH: Photic Stimulator part
XX: part number in a related batch	PC: Computer Case

The following figure shows a sample label of the equipment.

1.6. Guarantee specifications

Nr Sign guarantee its products for one (1) year, **only if**:

- All servicing, repairing, modification or new settings are performed only by Nr Sign or its authorized representative introduced in this user manual.
- Any installation or change in hardware or software is done by Nr Sign or its authorized representative.
- Device is used according to the user manual.
- Device is used by qualified person (e.g. Physician)
- Installation site of the equipment is in accordance with the corresponding requirements.



Note: *If installation is performed by Nr Sign, guarantee starts from the date of finishing installation and training.*

1.6.1. Guarantee exclusions

Nr Sign guarantee do not include the problems resulted from the following items:

- Any system misuse or abuse by customer

- Accessories (e.g. Electrodes, wires, cartridges...) are not under guarantee
- Any damage resulted from ignoring the instructions available in user manual (e.g. installation site conditions, environmental conditions...)
- Any defect in system hardware or software because of power line disturbance, loss or sudden change of electrical power
- Any physical damage occurrence for any reason
- Changing system installation place without consulting Nr Sign INC.
- Unauthorized repairs or modification
- Any problem or damage resulted during shipment transport



Note: Nr Sign only guarantees those devices which are directly bought from Nr Sign Manufacturing Co. or its authorized representative.



Note: Customer is responsible for consulting with Nr Sign experts before changing system installation place; otherwise, company will not be responsible for relevant consequences and also for providing relevant guarantee items which are affected by such movement.

1.6.2. Technical support information

The device can be used up to 10 years

Nr Sign and its authorized representative are responsible for offering the following services for customers whose device is still under guarantee:

- Technical support required for helping users about the equipment or its software can be provided via Telephone or online help from our website via team viewer
- Repair or replace defected parts except for those mentioned in guarantee exceptions.
- All replaced parts become NrSign property.
- Any repaired or replaced parts will be guaranteed for the **rest of guarantee period or 3 months, whichever is longer.**

1.6.3. Customer support information

In case of any failure in system function or any defect occurrence, customer must inform NrSign or its authorized representative as soon as possible for further actions.



Note: Customer is not allowed to fix, repair or service the equipment independently or by any other person except Nr Sign service personnel or authorized representative without Nr Sign written permission; otherwise, the guarantee items mentioned in this user manual are not applicable any more. Also, Nr Sign will not be responsible for any resulted consequences.

Customers can get Nr Sign support in case of need for help or training. Customers can report their system problems or request for servicing activities by Telephone/ Fax at 001-604-9455302 or email at zoya@nrsign.com and service@nrsign.ca is required, or mail Nr Sign at

Nr Sign INC,

#202, 109 Braid street, New Westminster, BC, V3L5H4

Website: www.NrSign.com



Note: Do not send back your equipment without any consultation with NrSign Manufacturing Company.

Note: send back the device according to annex 1 packaging instruction.

2. System overview

2.1. General

2.1.1. NR SIGN 3840 EEG Routine

Hardware:

Routine EEG or clinical EEG is used for recording brain electrical activities for diagnosis purposes. It has the following parts:

- 32 channel Head box with its cables
- Interfacing box
- Photic stimulator and arm
- Isolation transformer in case of requires
- PC in case of requires with Microsoft Windows XP
- NRSIGN application software
- Trolley in case of requires
- Printer in case of requires
- EEG accessories
- Keyboard, mouse and other accessories in case of requires
- Optional video EEG recording in case of requires

Software:

- Full programmable functions such as:
 - o Montage manager
 - o Automatic pattern for EEG signals recording
 - o Automatic calibration

- Navigator
- Selection program (for selecting and extracting special area in recorded signal)
- Montage Editor

Test results can be reviewed even electronically or in printed format. User has the opportunity in printing selected parts of the recorded signals.

Routine EEG is shown in the following picture:



2.1.2. NRSIGN 500Q EEG Monitoring

Hardware:

NRSIGN 500Q monitoring aimed for monitoring and recording brain electrical activities in long term mode to help professionals in diagnosing neural diseases. It has strong amplifier, easy and user friendly recorder and reader, and flexible configuration with 32, 64 and 128 channels.

EEG Monitoring contains the following parts:

- Low weight and portable head box up to 128 channels with its cables

- Interface box
- Isolation transformer
- PC (with Microsoft Windows XP/ Vista/ Seven Professional operating system and NRSIGN application software)
- Trolley
- Printer
- EEG monitoring accessories
- High quality video and audio recorder (MPEG quality, High resolution, digital and Analog zoom)
- Photic stimulator and arm
- Optional network facilities
- Optional extra monitor
- Nurse call cable and push button
- Optional Microphone and camera

Following picture shows 5000Q EEG Monitoring:



Software:

In the following some of the main features and specifications of the NRSIGN 5020 are listed:

- Full programmable function such as:
 - Montage manger, montage figure
 - Automatic and programmable review speed
 - Re montage, Re filtering, Re sensitivity
 - Optional extra channel
 - Optional surface EMG channels
 - Optional ECG channel
 - Upgradable to VEP system
 - Optional notch filter to omit 50 Hz or 60 Hz
 - Impedance checking
 - Up to 5 strong recorders via Ethernet
- Strong review software (Reanalysis facilities, event navigator, event marker, easy annotation and signal selection, summarizing all events on marking bar for long and short time)
- Reviewing real time data , video and audio monitoring on network
- Programmable filter, scale, time division, sample rate
- Optional archive data
- Patient event marker

Test results can be reviewed even electronically or in printed format. User has the opportunity in printing selected parts of the recorded signals.

2.2. Head box

NRSIGN head box is designed for collecting, amplifying and filtering the recorded EEG brain signals by 32, 64 or 128 channels. Both pre amplifier and amplifier are inside the head box. The recorded signal is first amplified by a bio pre amplifier, then filtered and at the end amplified and become ready to be digitized in interface box.



NR SIGN 3840

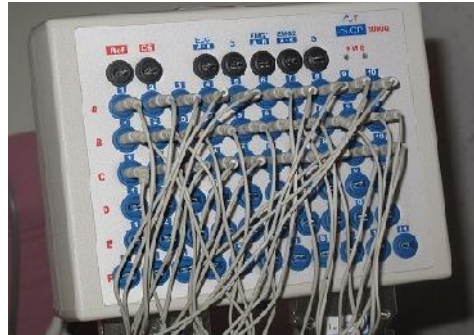

NR SIGN 5000Q

2.3. Interface

Interface is responsible for digitizing the amplified acquired signals and delivering them to PC. The output of interface box is connected to PC via USB cable. For increasing patient safety the interface box is isolated from head box. Interface box also contains EEG power and uses 110-220 V (both 50 and 60 Hz) and 1500V isolated from isolating power system; this part provides the required voltage for head box and photic stimulator. There is also a patient push button which get event from patient during the test.

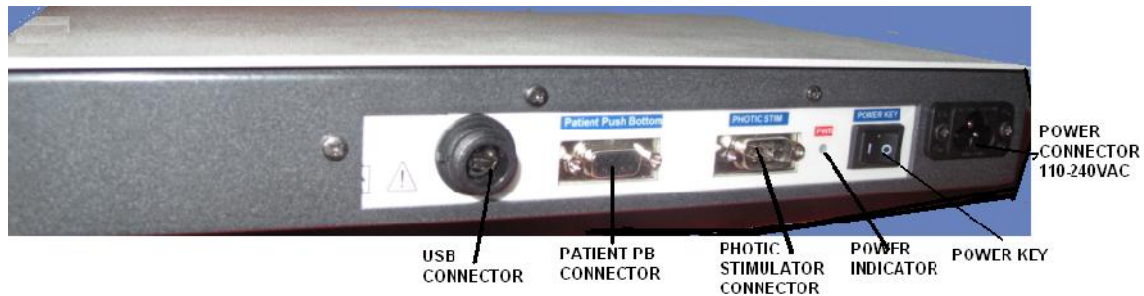

2.4. Photic stimulator

Photic stimulator is used to investigate anomalous brain activity triggered by specific visual stimuli and often used to diagnose conditions such as photosensitive epilepsy. Photic stimulator is connected to interface. Its stimulation duration is alternative and can be set by software manually. Its frequency range is 0-50 Hz.



Isolation power system



For increasing patient safety we use an isolating power system. Different parts of the system shall be powered from isolating power system which is isolated from main line voltage for 2500 V.

2.5. Digital Video recording device

Nr Sign equipped its EEG monitoring systems with digital video recording system, which is optional for routine EEG systems. This system is responsible for video recording the patient during the test. The acquired information is sent to computer via an USB TV box or IP Camera.

2.6. Accessories

Following table shows NR SIGN 3840 routine EEG and NR SIGN 5000Q EEG monitoring accessories:

Picture	Description																
	<p>EEG Cap</p> <p>Recommended for routine EEG</p> <table border="1"> <thead> <tr> <th>Part No.</th> <th>Name</th> <th>Item per package</th> </tr> </thead> <tbody> <tr> <td>02E-02C-01</td> <td>Small EEG cap</td> <td>1</td> </tr> <tr> <td>02E-02C-02</td> <td>Large EEG cap</td> <td>1</td> </tr> </tbody> </table>	Part No.	Name	Item per package	02E-02C-01	Small EEG cap	1	02E-02C-02	Large EEG cap	1							
Part No.	Name	Item per package															
02E-02C-01	Small EEG cap	1															
02E-02C-02	Large EEG cap	1															
	<p>EEG electrode</p> <p>Recommended for routine EEG</p> <table border="1"> <thead> <tr> <th>No.</th> <th>Part No.</th> <th>Name</th> <th>Item per package</th> </tr> </thead> <tbody> <tr> <td>1</td> <td>02E-01E-00</td> <td>EEG electrode</td> <td>22</td> </tr> <tr> <td>2</td> <td>02E-01E-01</td> <td>EEG electrode cover</td> <td>50</td> </tr> <tr> <td>3</td> <td>02E-01E-02</td> <td>EEG electrode rubber ring</td> <td>50</td> </tr> </tbody> </table> <p>Put these electrodes in the solution of salt and water before using</p>	No.	Part No.	Name	Item per package	1	02E-01E-00	EEG electrode	22	2	02E-01E-01	EEG electrode cover	50	3	02E-01E-02	EEG electrode rubber ring	50
No.	Part No.	Name	Item per package														
1	02E-01E-00	EEG electrode	22														
2	02E-01E-01	EEG electrode cover	50														
3	02E-01E-02	EEG electrode rubber ring	50														

Picture

Description



Collodion

Recommended for EEG monitoring or brain death situation

No.	Part No.	Name	Item per package
1	02E-05A-00	Collodion	5



Silver disc-electrode with single-sided plastic-cover

For both routine and EEG monitoring systems

No.	Part No.	Name	connector	Item per package
1	01M-08P-01	Silver disc electrode with single sided plastic-cover	With 2mm plug	1
2	01M-08P-02	Silver disc electrode with single sided plastic-cover	With 1.5mm TP-plug	1
3	01M-08P-03	Silver disc electrode with single sided plastic-cover	With dipole plug	1
4	01M-08P-04	Silver disc electrode with single sided plastic-cover	With Sony plug	1
5	01M-08P-05	Silver disc electrode with single sided plastic-cover	With Stereo plug	1



Ten 20

Recommended for routine EEG in case of using disc electrodes

No.	Part No.	Name	Item per package
1	02E-04T-00	Ten20 conductive paste	1

Picture Description



Abrasive

For both routine and EEG monitoring systems

No.	Part No.	Name	Item per package
1	02E-06N-00	Nuprep Skin Preparation Gel	1



EEG wire

Recommended for routine EEG

No.	Part No.	Name	Connector	Wire Length	Item per package
1	02E-03W-010	Mini-crocodile EEG wire	With Sony plug	120cm shielded wire	22
2	02E-03W-011	Mini-crocodile EEG wire	With 2mm plug	120cm unshielded wire	22
3	02E-03W-012	Mini-crocodile EEG wire	With 1.5mm TP-plug	120cm unshielded wire	22
4	02E-03W-013	Mini-crocodile EEG wire	With dipole plug	120cm shielded wire	22
5	02E-03W-014	Mini-crocodile EEG wire	With Stereo plug	120cm shielded wire	22
6	02E-03W-020	Alligator EEG wire	With Sony plug	120cm shielded wire	22
7	02E-03W-021	Alligator EEG wire	With 2mm plug	120cm unshielded wire	22
8	02E-03W-022	Alligator EEG wire	With 1.5mm TP-plug	120cm unshielded wire	22
9	02E-03W-023	Alligator EEG wire	With dipole plug	120cm shielded wire	22
10	02E-03W-024	Alligator EEG wire	With Stereo plug	120cm shielded wire	22



Ground electrode









Recommended for routine EEG. please connect it to CG connector in head box and the patient wrist in other side

No.	Part No.	Name	connector	Item per package
1	01M-07G-01	Ground electrode	With 4mm plug	1
2	01M-07G-02	Ground electrode	With 2mm plug	1
3	01M-07G-03	Ground electrode	With 1.5mm TP-plug	1
4	01M-07G-04	Ground electrode	With Sony plug	1
5	01M-07G-05	Ground electrode	With Stereo plug	1
6	01M-07G-06	Ground electrode	With dipole plug	1



Silver/Silver chloride- (Ag/AgCl)- electrodes

Silver- (Ag) electrodes

Picture	Description																														
	<p>Gold-(Au) electrodes</p> <p>For both routine and EEG monitoring systems & Recommended for EEG monitoring systems</p> <table border="1"> <thead> <tr> <th>Electrode type</th> <th>Electrode material</th> <th>Cable type</th> <th>Cable length</th> <th>Plug configuration</th> </tr> </thead> <tbody> <tr> <td>DS=disc electrode stamped</td> <td>1= Silver</td> <td>0= Shielded</td> <td>0 =Without cable</td> <td>0= Without plug</td> </tr> <tr> <td>DC=disc electrode casted</td> <td>2 =Silver/ Silver chloride</td> <td>1=Unshielded</td> <td>1= 15cm cable length</td> <td>1= With 2mm plug-even, long </td> </tr> <tr> <td></td> <td>3= Gold</td> <td></td> <td>2= 120cm cable length</td> <td>2= With 1.5mm TP-plug </td> </tr> <tr> <td></td> <td>4= Tin (only in 10mm casted and moulded version)</td> <td></td> <td>3=150 cm cable length</td> <td>3= With dipole plug </td> </tr> <tr> <td></td> <td>5 =Silver/ silver chloride sintered (in execution moulded available)</td> <td></td> <td></td> <td>4= With Sony plug</td> </tr> </tbody> </table> <p>Part No. of these electrodes can be described by putting the above table columns contents respectively. (e.g. DS1000 = Disc electrode, silver, shielded, without cable, without plug)</p>	Electrode type	Electrode material	Cable type	Cable length	Plug configuration	DS=disc electrode stamped	1= Silver	0= Shielded	0 =Without cable	0= Without plug	DC=disc electrode casted	2 =Silver/ Silver chloride	1=Unshielded	1= 15cm cable length	1= With 2mm plug-even, long 		3= Gold		2= 120cm cable length	2= With 1.5mm TP-plug 		4= Tin (only in 10mm casted and moulded version)		3=150 cm cable length	3= With dipole plug 		5 =Silver/ silver chloride sintered (in execution moulded available)			4= With Sony plug
Electrode type	Electrode material	Cable type	Cable length	Plug configuration																											
DS=disc electrode stamped	1= Silver	0= Shielded	0 =Without cable	0= Without plug																											
DC=disc electrode casted	2 =Silver/ Silver chloride	1=Unshielded	1= 15cm cable length	1= With 2mm plug-even, long 																											
	3= Gold		2= 120cm cable length	2= With 1.5mm TP-plug 																											
	4= Tin (only in 10mm casted and moulded version)		3=150 cm cable length	3= With dipole plug 																											
	5 =Silver/ silver chloride sintered (in execution moulded available)			4= With Sony plug																											
	ECG electrode																														
	EEG Monitoring ground wire																														

3. Preparing and starting system

NRSIGN series can be installed by either NrSign service personnel or customer. Please follow the instruction available in clause 10 of this User Manual for System installation for the first time. After hardware installation, all required software (if do not install by NrSign) shall be installed on computer (see clause 9). After installation completion, you can operate the system according to the following instruction.

3.1. Start-Up

Every time before starting and using the system, user is asked to check that the equipment and its accessories are in normal condition. Make sure that the environmental condition is in accordance with the conditions mentioned in this user manual.

If you are using NRSIGN systems for the first time, please see clause for system setting up.

3.2. Switching on the NRSIGN System

For switching on the system, first make sure that the isolation transformer is off. Then:

- 1) Connect the system to the standard outlet (grounded outlet).
- 2) Turn on the isolation transformer in case of requires.
- 3) Turn on the computer, so Windows will start. Enter any Username or Password if necessary.
- 4) Turn on power switch on the NRSIGN interface box, so its power indicator will turn on.
- 5) Turn on power switch on the head box so its power indicator will turn on.
- 6) Double click on NRSIGN symbol on the desktop.
- 7) Use and set up the software according to below description

3.3. Switching NRSIGN System off

For switching off the system do the following steps:

- 1) Close all program windows.
- 2) Shut down Windows by clicking Start on the Windows task bar and clicking Turn off Computer icon.
- 3) Switch off NRSIGN with power switch on head box and interface.
- 4) Turn off the isolation transformer.

3.4. NRSIGN view

Front view of NR SIGN 5000Q EEG monitoring

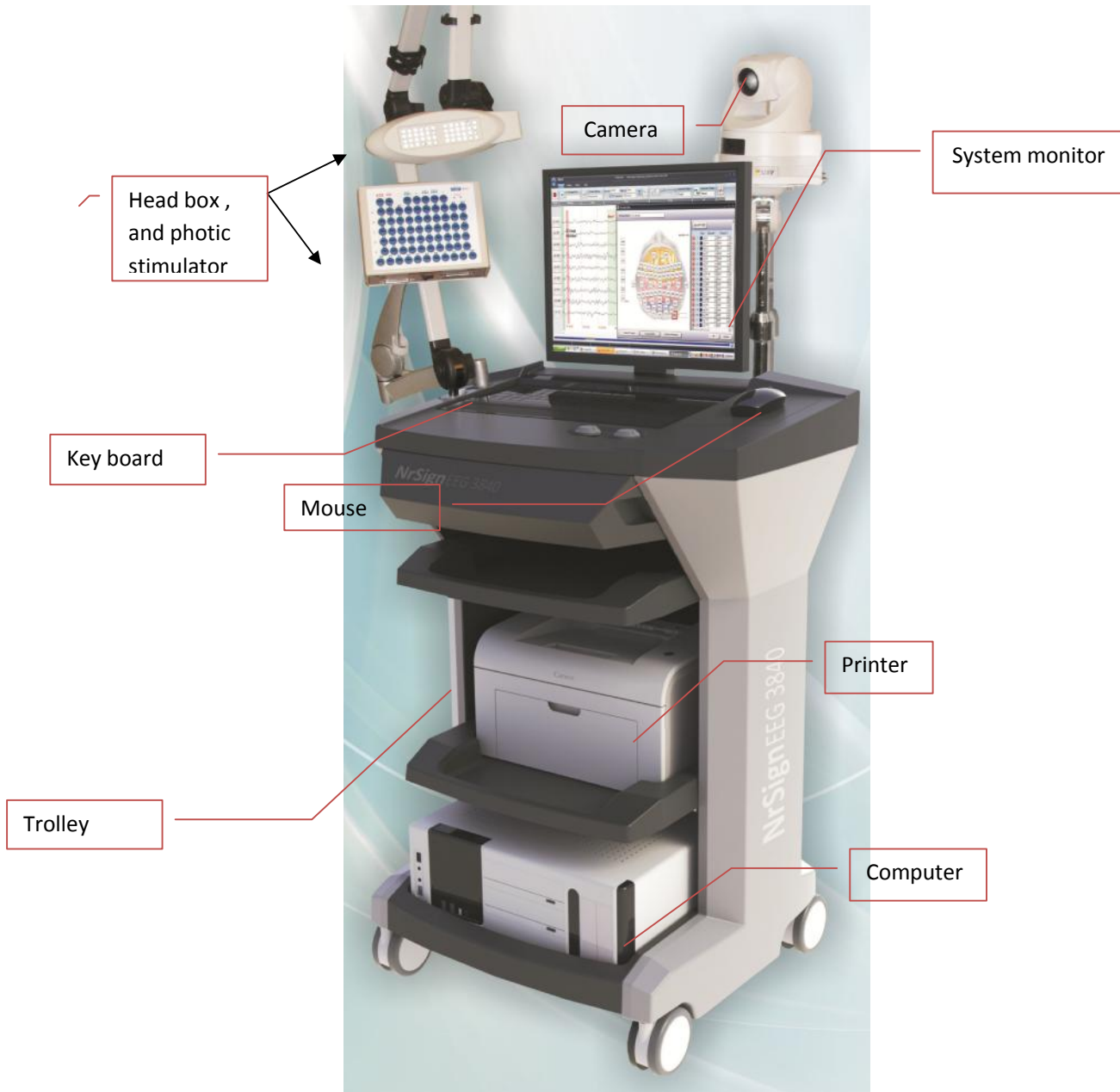

Front view of NR SIGN 3840 routine EEG



3.4.1.1. Detail view of interface



The interfacing box should be on the trolley and it should not be accessible for patient.

Following figures show NRSIGN panels:

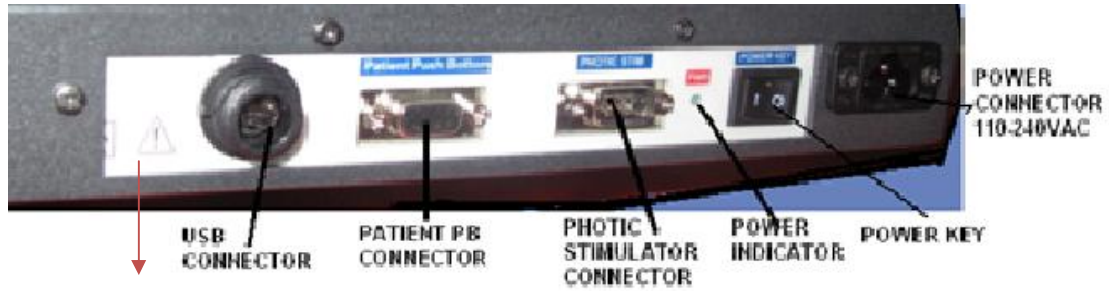

Refer to user manual

1. Patient push button connector for EEG NR SIGN 5000Q



Receive event from patient via a special cable connected to patient event push button

2. USB connector



Connect interface to PC via EEG USB cable

3. Symbol of referring User Manual



4. PHOTIC STIMULATOR connector



Photic stimulator is connected to interface from this part

5. PWR indicator

Power indicator shows EEG power supply

6. Power key



for turning on/off the interface box

7. AC power connector:



An interfacing power cord and should connect to isolated power supply or power line.

Interfacing Side view

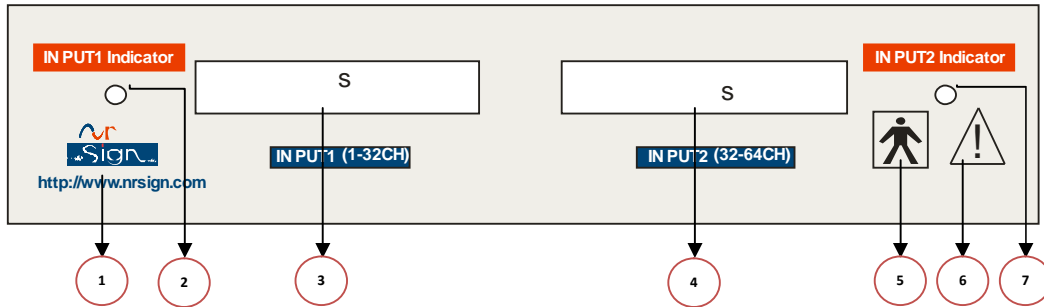

- 1 **NRSIGN web address**
- 2 **Input indicator1**
Show that the first 32 channel output of head box is connected to interface
- 3 **Input connector1**
Connect output of 32 channels of head box to interface via EEG cable
- 4 **Input connector2**
Connect output of 32 channels of head box to interface
Note: for EEG NR SIGN 3840, this connector is not available.
- 5 **Symbol of BF Type applied part**
- 6 **Symbol of referring User Manual**
- 7 **Input indicator2**
Show that the rest of 32 channels output of head box is connected to interface (only for 64ch head box)



Note: please consider the direction of part A in the EEG USB cable

3.4.1.1. Detail view of Photic stimulator

PHOTIC STIMULATOR BACK view

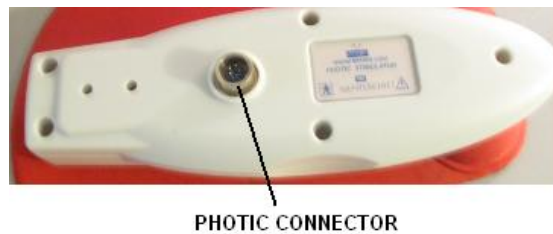

Photic is connected to interface via Photic stimulator cable and connector

3.4.1.2 Detail view of Video Camera

a. Using the capture and camera

Digital video camera is connected to computer via USB TV Box, following pictures show video camera:



Video recording system

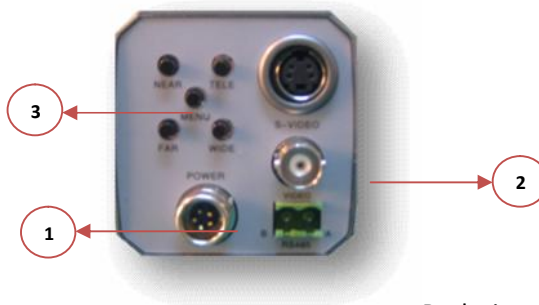

Back view

- 1 **Power connector** should connect to power outlet
- 2 **Video output connector** sends the recorded video signals to capture
- 3 **Adjustment keys** are used for any adjustment purposes

This video shall be connected to a USB TV Box which is showed in the following:



Capture view

- 1 **MMI connector** connect to video recording
- 2 **USB connector** sends the recorded information to PC

b. Using the IP camera

1. Axis M114 IP camera

power over Ethernet IEEE 802.3 class 1



Hardware overview

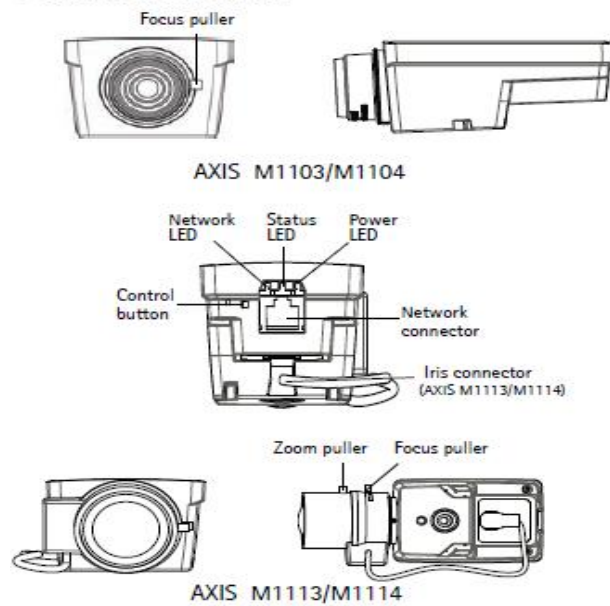

Please use this link for more detail:

http://www.axis.com/files/manuals/ig_m11_40480_en_1009.pdf

2. Axis PTZ 214 IP camera;

The installation is as same as M1114, but it has AC adaptor instead of the POE.



Detail view of head box - NR SIGN 3840 routine EEG

Following picture shows top foil of head box of NR SIGN 3840 routine EEG.

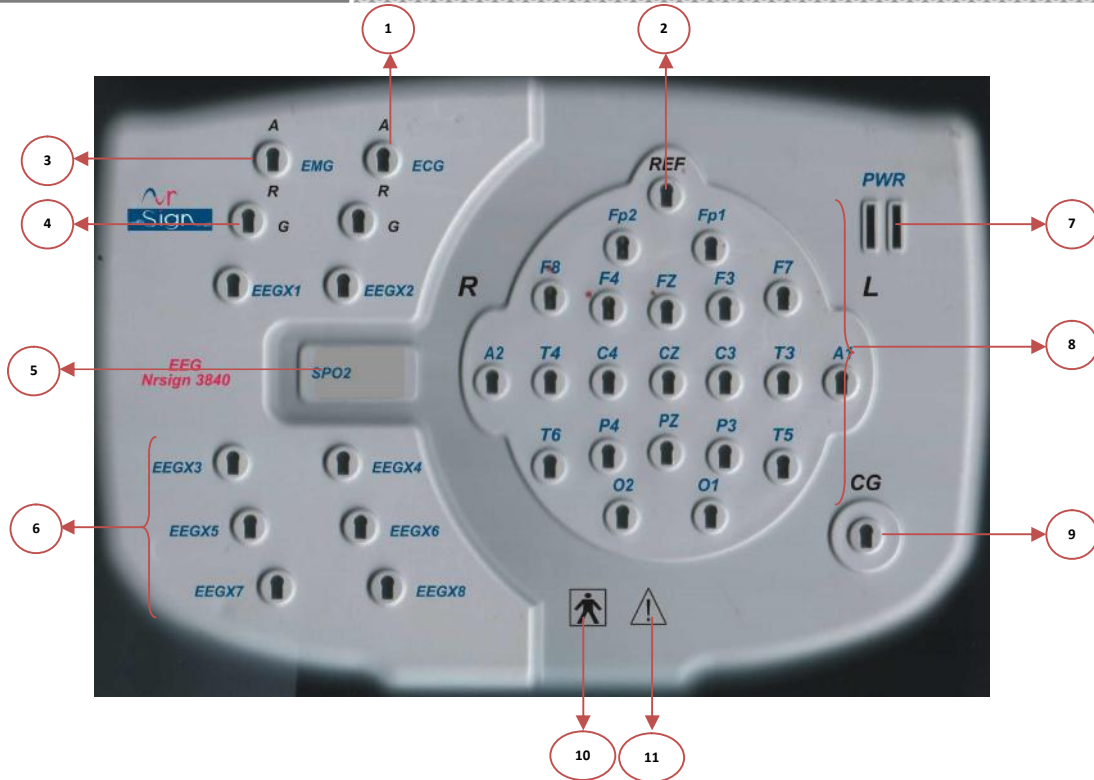

- 1 **ECG connector** connect to patient left and right chest
- 2 **REF connector** is system recording reference connector which we recommend to connect to Z or FZ point via disc electrodes or plastic basis electrodes and usual hat.
Note: this connection is very important, if there is a disconnection or loos connection, the EEG signals cannot be recorded.
- 3 **EMG connector** can be connected to desire muscles to indicate surface EMG
- 4 **G connector** connect to below of patient left chest to omit the noise via disposables ECG electrode
- 5 **SPO2 (optional)**
- 6 **EEGX1...EEG x8** are extra channels. [Please see appendix A](#)
- 7 **PWR** is power indicator. It turns on when the head box switch is on.
- 8 **FP1, FP2, FZ...O1, O2** are connectors on head shape which should be connected to patient scalp via Disc electrodes or plastic basis electrodes and usual hat.
- 9 **CG connector** is common ground connector which we recommend to connect to patient wrist via wrist electrode.
Note: this connection is very important, if there is a disconnection or loos connection, the EEG signals cannot be recorded.
- 10 **Symbol of BF Type applied part**

11 Symbol of referring User Manual

Note: connecting REF connector to FZ and CG CONNECTOR to patient wrist or shoulder is essential.

Side view

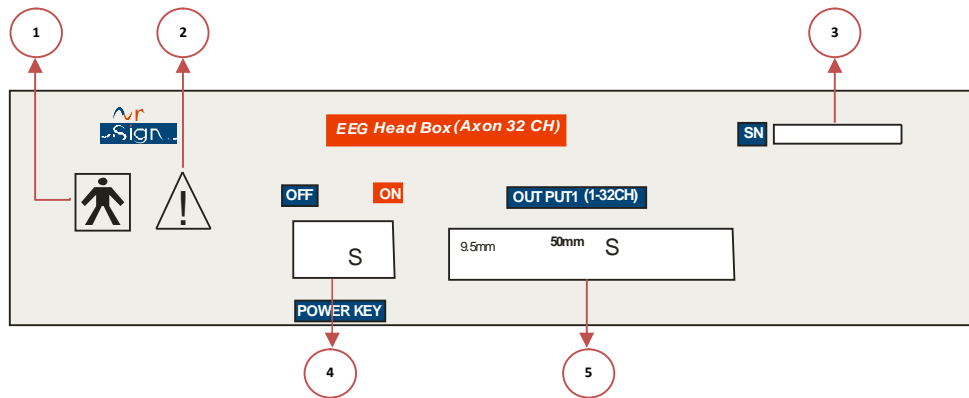

1 Symbol of BF Type applied part

2 Symbol of referring User Manual

3 Serial Number

4 Power key (on/off)

5 Output connector1
Connect output of 32 channels of head box to interface via EEG cable.

- **Detail view of head box - NR SIGN 5000Q EEG monitoring**

Following picture shows top foil of head box- 64 channel.

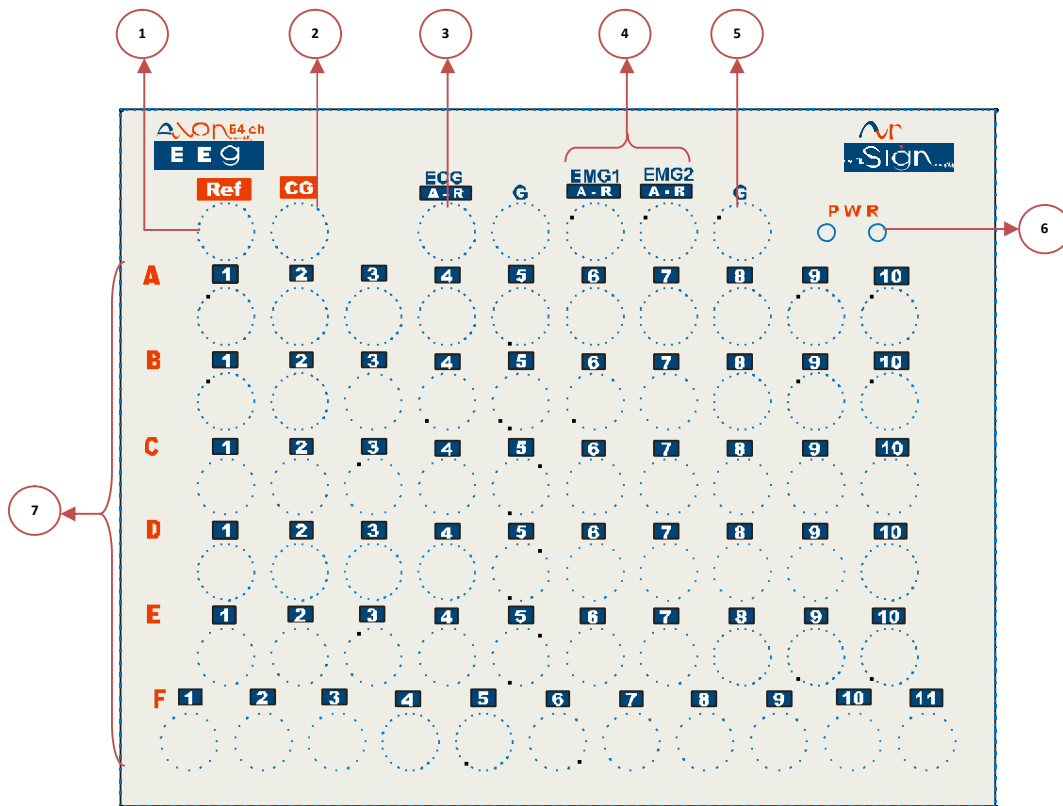

- 1 **Ref connector** is system recording reference connector which we recommend to connect to Z or FZ point via Disc electrodes.
- 2 **CG connector** is common ground connector which we recommend to connect to patient shoulder in case of long term EEG monitoring via disposables ECG electrode.
- 3 **ECG connector** should connect to patient left and right chest and connect G connector below of patient left chest to omit the noise via disposables ECG electrode.
- 4 **EMG connectors** can be connected to desire muscles to indicate surface EMG. This connector includes active and reference connector, please use second G connector to omit possible noise.
- 5 **G connector**
Ground connector for ECG and EMG test which connect to patient wrist
- 6 **PWR** is power indicator. It turns on when the head box switch is on. PWR indicators show EEG power supply connections.



Note: The name of these connectors can be changed to desire name via NRSIGN software.

How to acquire the EEG signals:

- 1). Explain the patient about what are you going to do, so please explain a little about EEG
- 2) Please remind patient that their scalp skin shall be very clean, not any oil or jell
- 3) Clean the patient's scalp skin with abrasive Jell if you think that it is necessary
- 4) Connect electrode to the Scalp according to 10-10 system or 10-20 system
 - a) Set your desired montage according to 10-10 system or 10-20 system on the NR sign EEG software(please read the software operation on this user manual at first)
 - b) Use TEN 20 Jell if you are working with short term EEG (less than 20 hours EEG recording)
 - c) Use Clodion to stick the electrode on the Scalp and insert the EEG jell in the disc electrode if you are using the EEG monitoring devise (more than 2 hours EEG recording)
 - d) Please consider the below pictures for 10-10 system and 10-20 system for precisely measurement of the scalp to stick the electrodes
- 5) Ask your patient to be calm and relax
 - a) Please consider this part even you are using EEG monitoring devise for at least 10 minutes to capture the Alfa, or maybe Beta signals to make sure that everything is okay and there is not any undesirable environmental noise
- 6) make sure that the head box indicator are lightening with green color
- 7) Make sure that you did all of requirements according to 3-4-1-5, and 3-4-1-6 section on this user manual

10-10 system

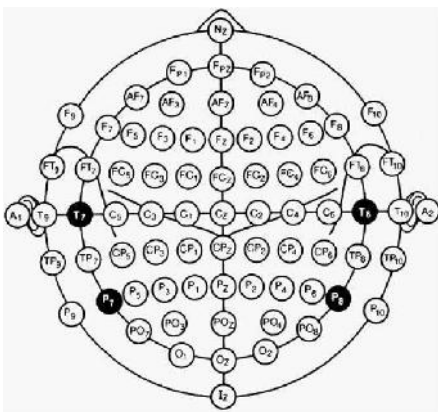

1. Elastic caps and electrodes



2. Easy cap and electrodes



3. Collodion and disc electrode



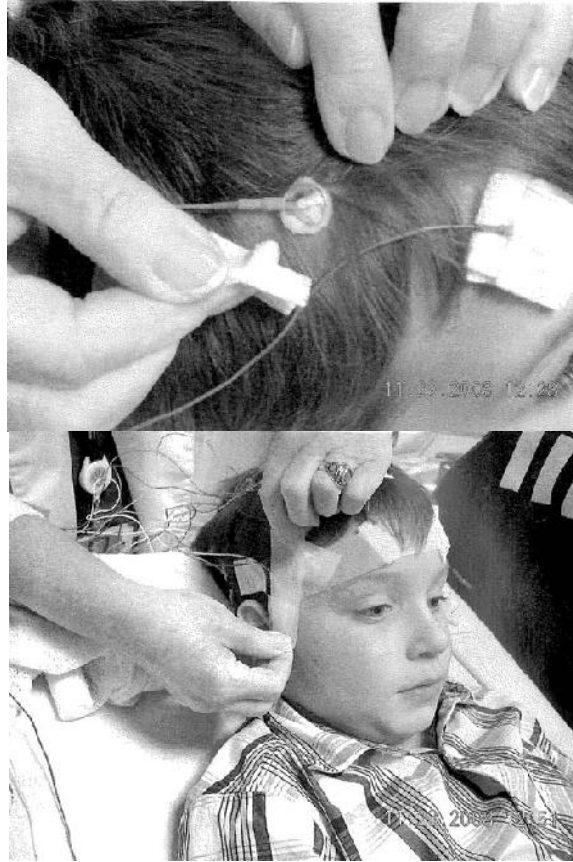

Side view of EEG 5000Q head box

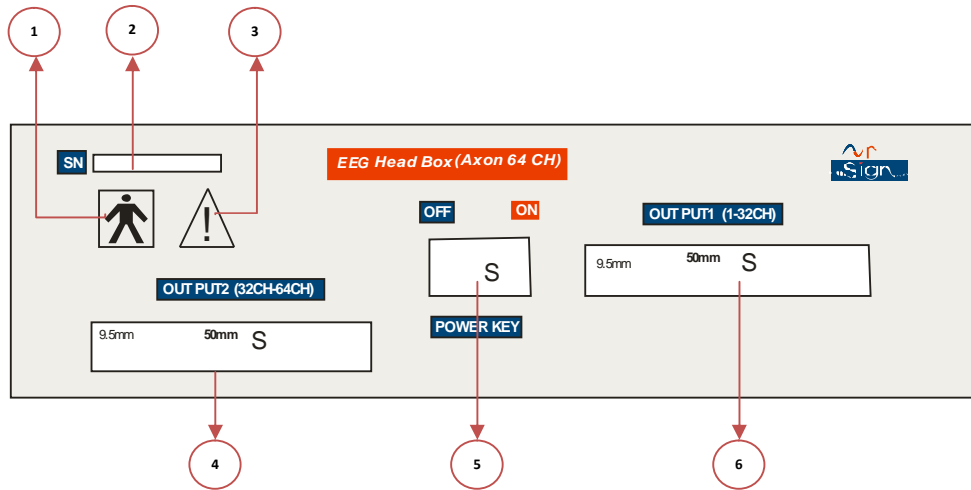

- 1 **Symbol of BF Type applied part**
- 2 **Serial Number**
- 3 **Symbol of referring User Manual**
- 4 **Input connector1**
Connect output of 32 channels of head box to interface
- 5 **Power key (on/off)**
- 6 **Input connector2**
Connect output of 32 channels of head box to interface

○ **System setting up**

Different parts of EEG equipment have been explained in the previous clauses, by following the instruction of this clause you can assemble and set up the system:

1) Install trolley

Please install trolley according to its instruction available in Trolley package.

2) Attachment of monitor to trolley

For attaching monitor to trolley do the following steps:

- a) Align the four-hole pattern on the back of the monitor with the four-hole pattern on the trolley as shown below:



- b) Guide the two opposite screws into the trolley mounting plate and tighten them, and then the remained screws.

3) Put each part of the equipment on its place

Put PC, Keyboard, Mouse, printer, Isolating transformer, Head box, Interface, Camera and Capture on their relevant places. Then start to connect them according to the following information.

4) Please screw the head box arm to head box



5) Head box connections to interface

a) For 64 channel head box:

Connect Output 1 (1-32 CH) and Output2 (32-64 CH) connectors on 64 channel head box to Input1 (1-32 CH) and Input2 (32-64 CH) on back of the interface with the following cable via Scazy female connector:



b) For 32 channel head box:

Connect Output 1 (1-32 CH) connector on head box (32 CH) to Input1 (1-32 CH) on back of the interface with relevant cable as shown above.

6) Interface connections

- a) Connect patient push button cable connector to patient push button 9 pin male D-connector on the back of the interface in case of using EEG 5000Q system
- b) Connect USB connector on the back of the interface to one of the USB connector on the back of PC with the EEG USB cable



Note: please consider the direction of part A in the EEG USB cable

- c) Connect 9 pin PHOTIC STIM D-connector on the back of the interface to photic stimulator by the following cable:

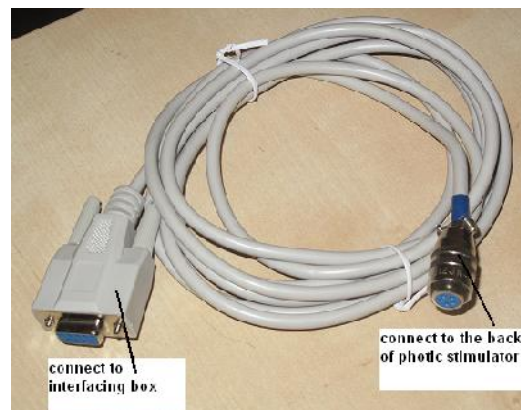

- d) Connect AC cable to the AC SOCKET connector on the back of interface to power line

3) PC connections

- a) Connect Mouse connector (PS2) to the mouse PS2 connector on the back of PC (if Mouse has USB connector, connect it to one of the USB connectors on the back of PC)
- b) Connect keyboard connector (PS2) to the keyboard PS2 connector on the back of PC (if keyboard has USB connector, connect it to one of the USB connectors on the back of PC)
- c) Connect monitor cable connector (DVI or VGA) to the back of PC



VGA Connection



DVI Connection



- d) Connect Printer USB cable connector to a USB connector on back of PC
- e) Connect USB cable from Interface to one of the USB connectors on the back of PC
- f) Connect any Network connector (if available) to network hub on PC



- g) Connect audio and microphone connectors to Audio and Mic connectors on the back of PC
- h) Connect Power cable to the back of the PC



4) Video camera connections (See also clause Error! Reference source not found.)

First choice: Using the capture device:

- a) Connect S-video connector on back of video camera to MMI connector on capture

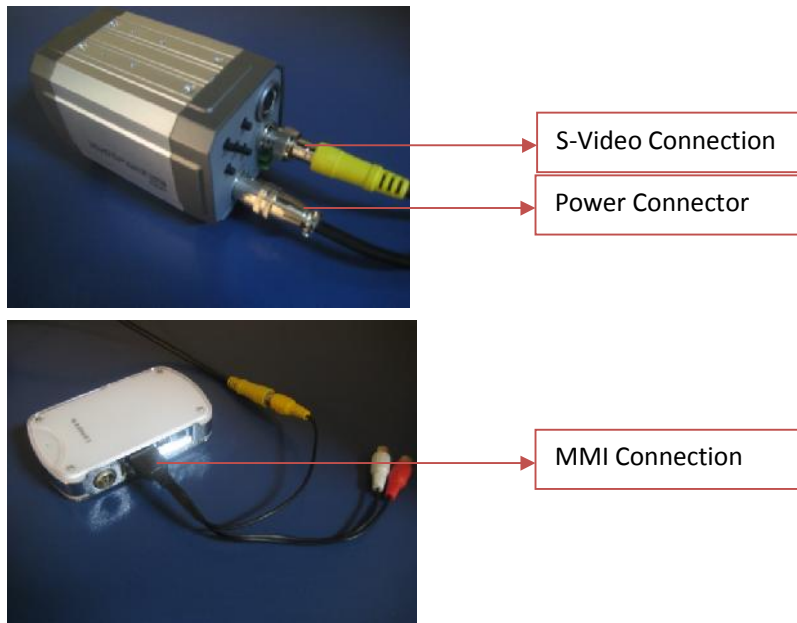

- a) Connect USB connector on the back of capture to on of the USB connector on back of PC by the following cable:
- b) Connect Power connector on the back of the video camera to one of the power output of isolating transformer

Using the IP Camera:

- a) Connect the "Network" connector of IP camera to "Data out and power" of POE (power over internet) device.
- b) Connect the "Data In" connector of the POE device to PC Ethernet connector or LAN data switch
- c) Connect the POE power line cable.

Please use the following link for more detail:

http://www.axis.com/files/manuals/ig_m11_40480_en_1009.pdf

5) Printer connection

- a) Connect Printer USB cable connector to a USB connector on back of PC
- b) Connect Printer power cable to one of the output of isolating transformer

6) Isolating power system connection

- a) PC, Camera, Printer, Interface box shall be supplied via isolating transformer
- b) Connect isolating transformer power cable to the standard outlet



Do not connect the other equipment to this isolated transformer. This is especially for the EEG system.

There are two model of isolation power supply, please check the voltage input of the part. If your power line voltage is 110, your isolated transformer shall be 178 DT. If your power line voltage is 220, your isolated transformer shall be 240 DT.



The below power cords type used as standard power cord for NR Sign INC products .

1. CEE 7/4 (German "Schuko" 16 A/250 V grounded) and CEE 7/5 (French) for 220V power input
2. NEMA 1-15 (15 A/125 V grounded) power cord is used for the system for 110V power input

The area shoed on the below picture must to connect to earthed power out let of user infrastructure as a protective earth of system

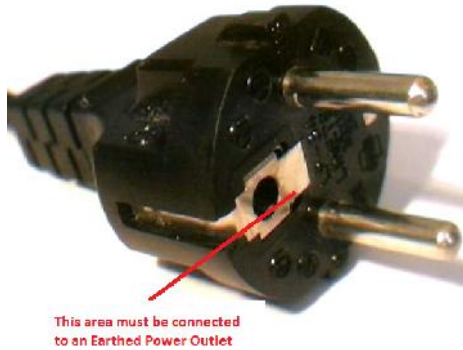

The power supply cord specification:

Gauge: 18, diameter: 1.024mm, area: 0.823 mm²

Insulation: PVC

Temperature range: 32 to 167 F

Voltage Rating: 300V

Color: Red or Brown for Phase, Blue for Null, and Green for Ground.

8. Installation of EEG interfacing software driver:

Please do the following steps **if you are using windows 7 (64 bits):**

- a) Make sure that all of required software installed on your computer and you do not have any unknown device on your computer before using this computer for EEG system
- b) Connect the interfacing box to computer with its USB cable and turn on the interfacing box (the green LED on the bottom side should be lightened)
- c) Click on control panel/ system/ device manager
- d) Identify the un known device and run click it, then click on update drive software beside of unknown device with yellow sign.
- e) Choose Brows my computer for software driver like below picture

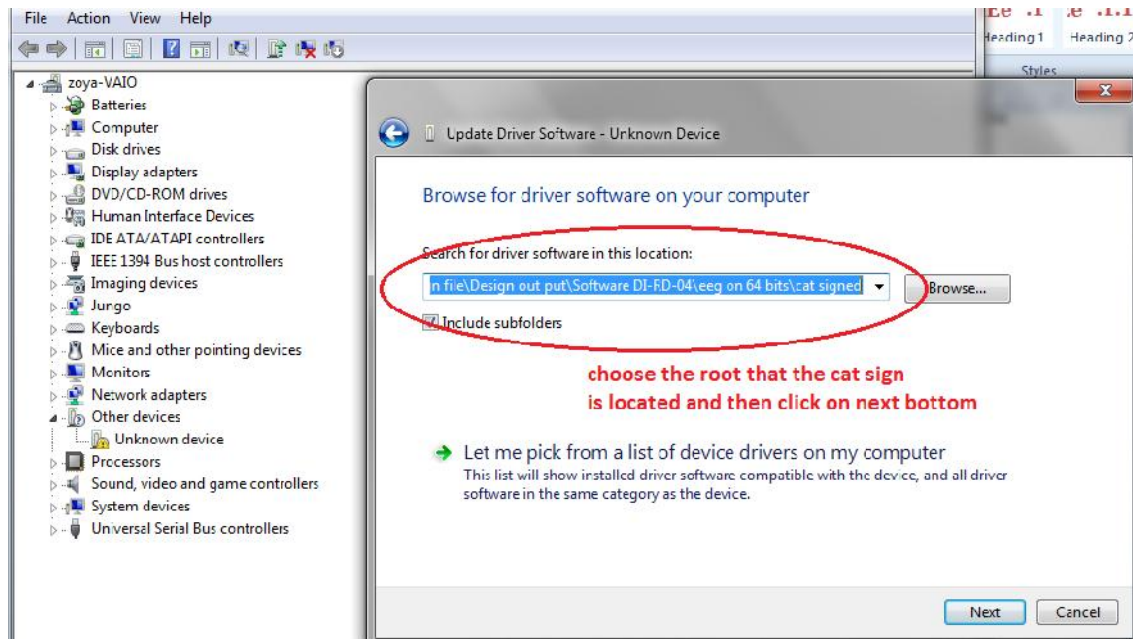

- f) The following window will be opened if you entered the right root, then click on the install bottom



- g) The following windows shall be appeared

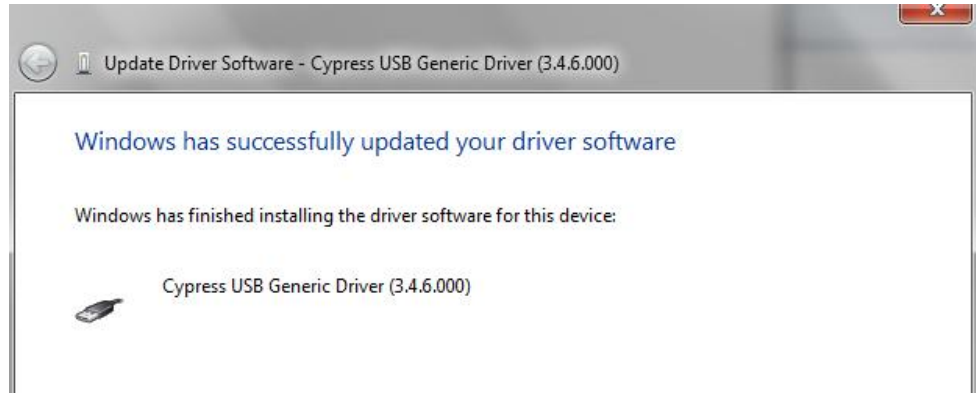

At the end in device manager should not appear any un known devise

9. Installation of Camera driver

Please install the capture device if you are using the video EEG with the Capture device and Analog Camera according to its CD driver, or install the IP camera if you are using the video EEG with IP camera according to this instruction:

- Please click on the Axis IP Utility and wait for the camera IP address coming up according to below picture, **please keep this address to use it in EEG software.**

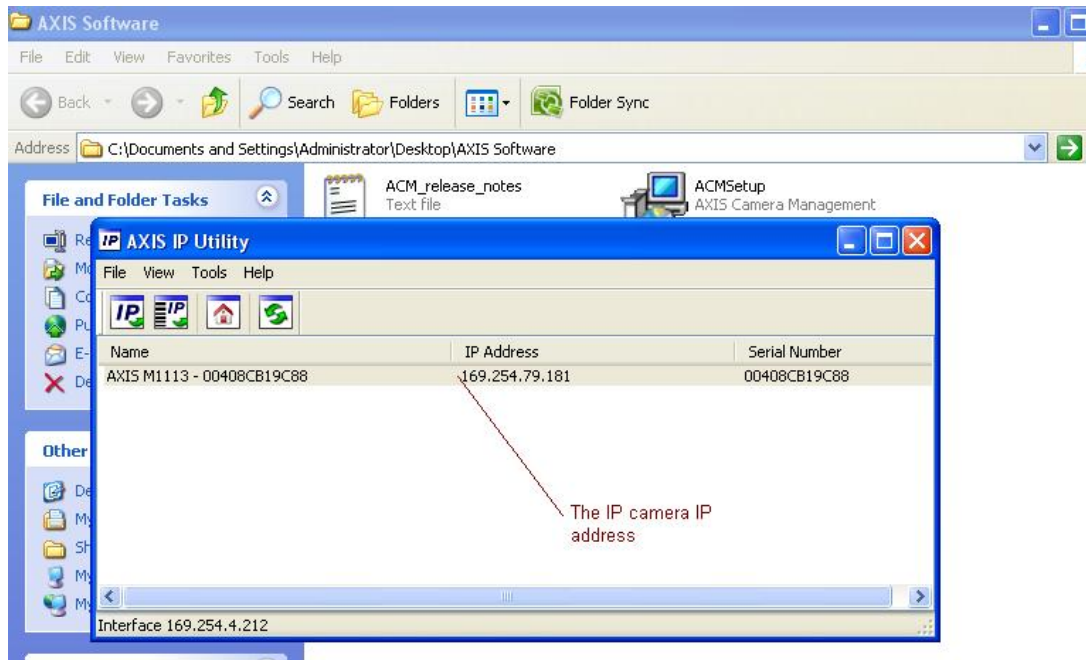

- Please double click on the Axis M1113 on the above window and wait for Axis camera windows coming up for setting of the camera and then enter the user name and password provided by NR SIGN INC when you purchased the system according to below picture.

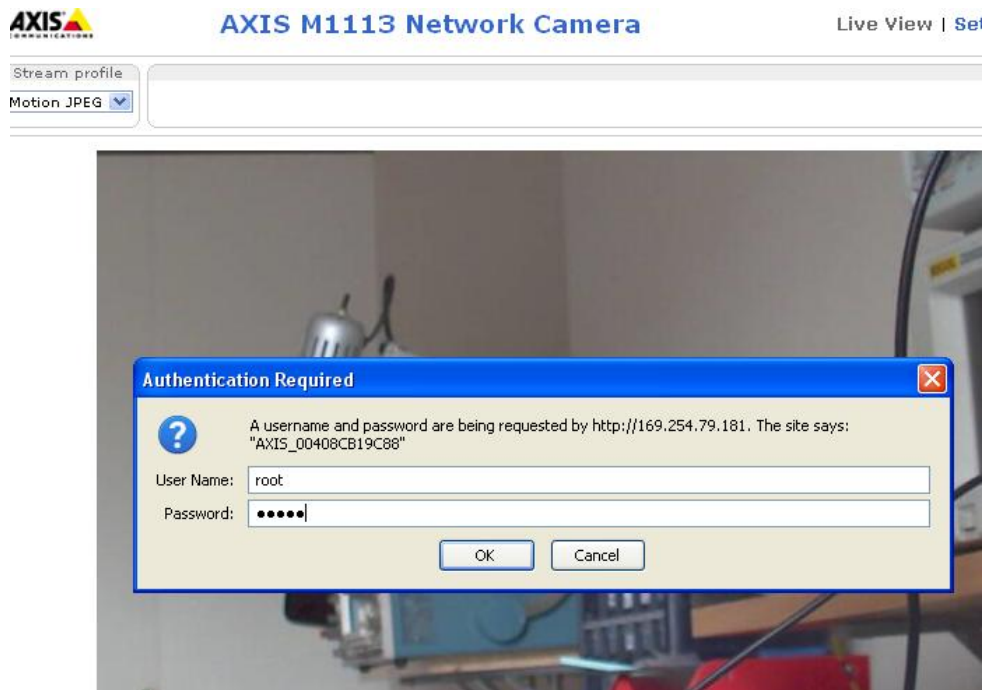

- Please click on setup / user on this windows and choose “no user name and password required” option according to below picture.

Note: this is an important item which should be chosen correctly

AXIS M1113 Network Camera Live View | Setup | Help

Users ?

User List

User Name	User Group	User Info
root	Administrator	

Add... Modify... Remove

HTTP/RTSP Password Settings

Allow password type: Encrypted & unencrypted

User Settings

- Enable anonymous viewer login (no user name or password required)
- Enable anonymous PTZ control login (no user name or password required)
- Enable Basic Setup

Save Reset

an important setting

○ NRSIGN EEG Software Installation

TABLE OF CONTENTS

1. Installation of Direct X provided by NR SIGN INC.
2. Installation of .NET frame work 3.5 provided by NR SIGN INC.
3. RUN NR SIGN EEG.
4. Set an EEG software options for running the software for first time.

- **Installation of the DirectX:**

For drawing the signals & recording the sound of patient, we use DirectX.

Installing step:

1. Open the path.
2. Click on the DirectX Setup in your NR SIGN EEG software package .
3. Check the agreement and click next.

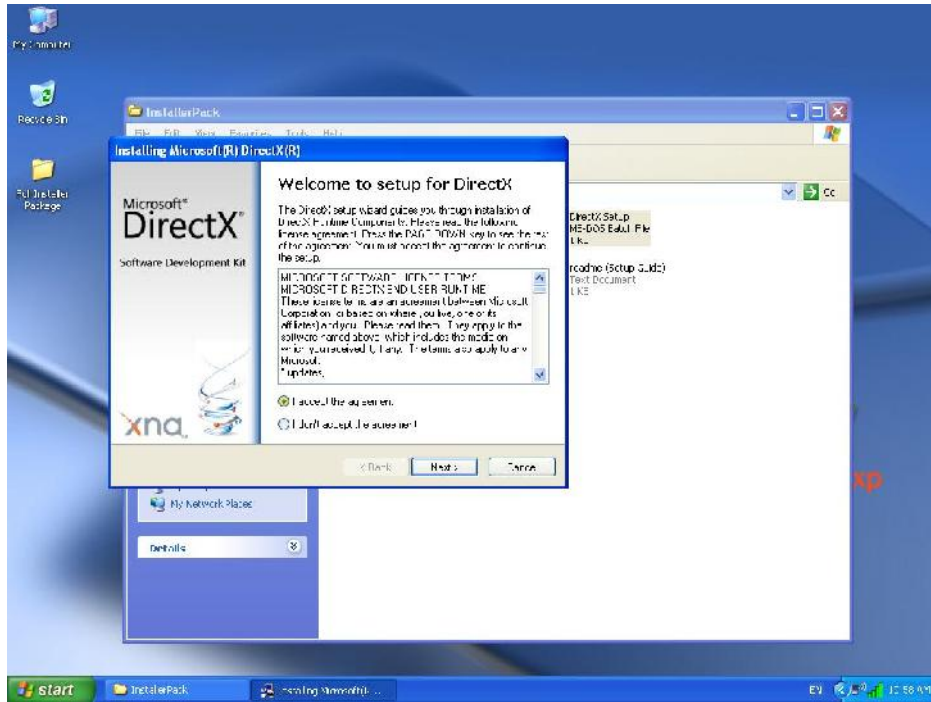

4. Click the Next button.

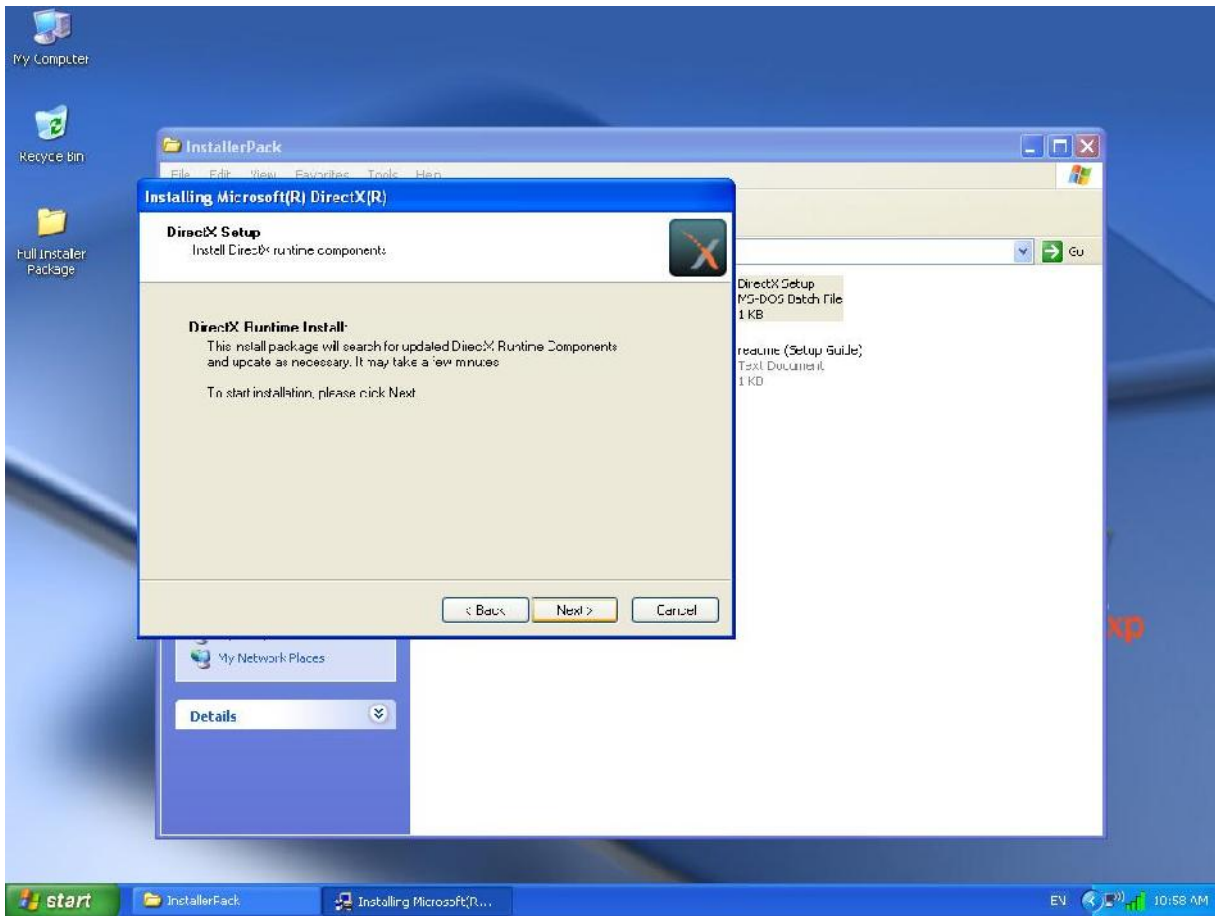

5. Wait for the installation of the components

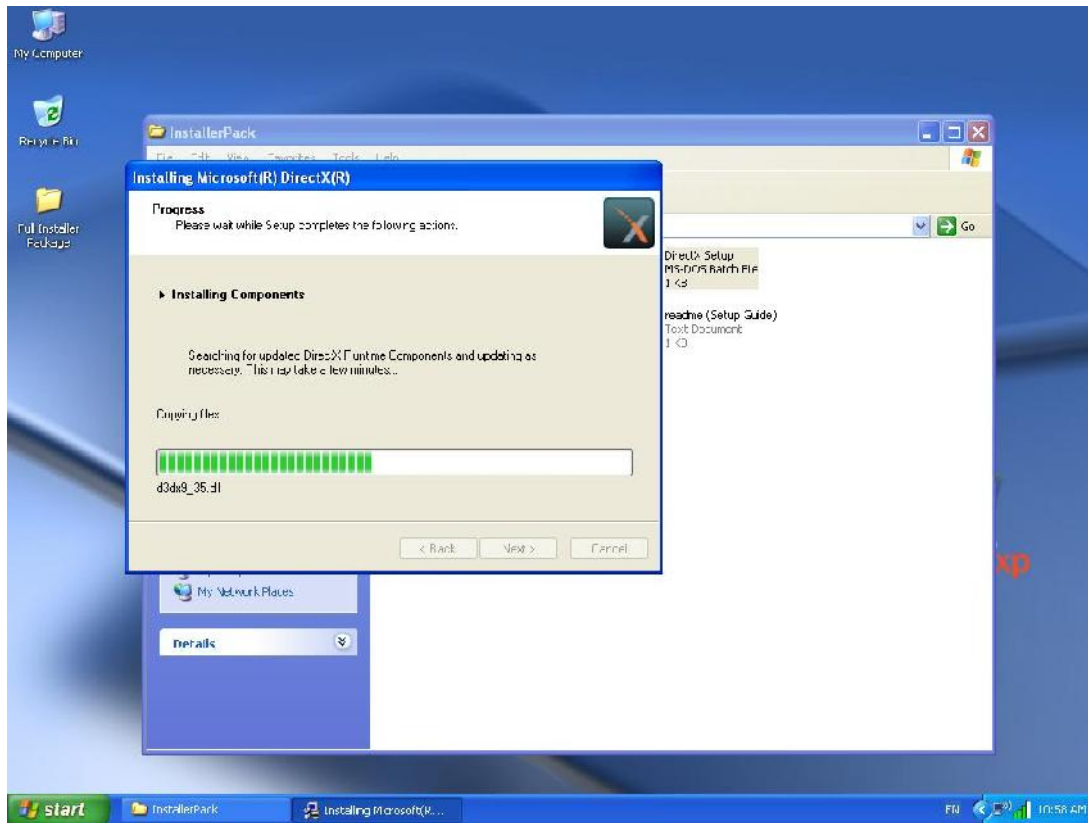

6. Click Finish button to complete the installation.

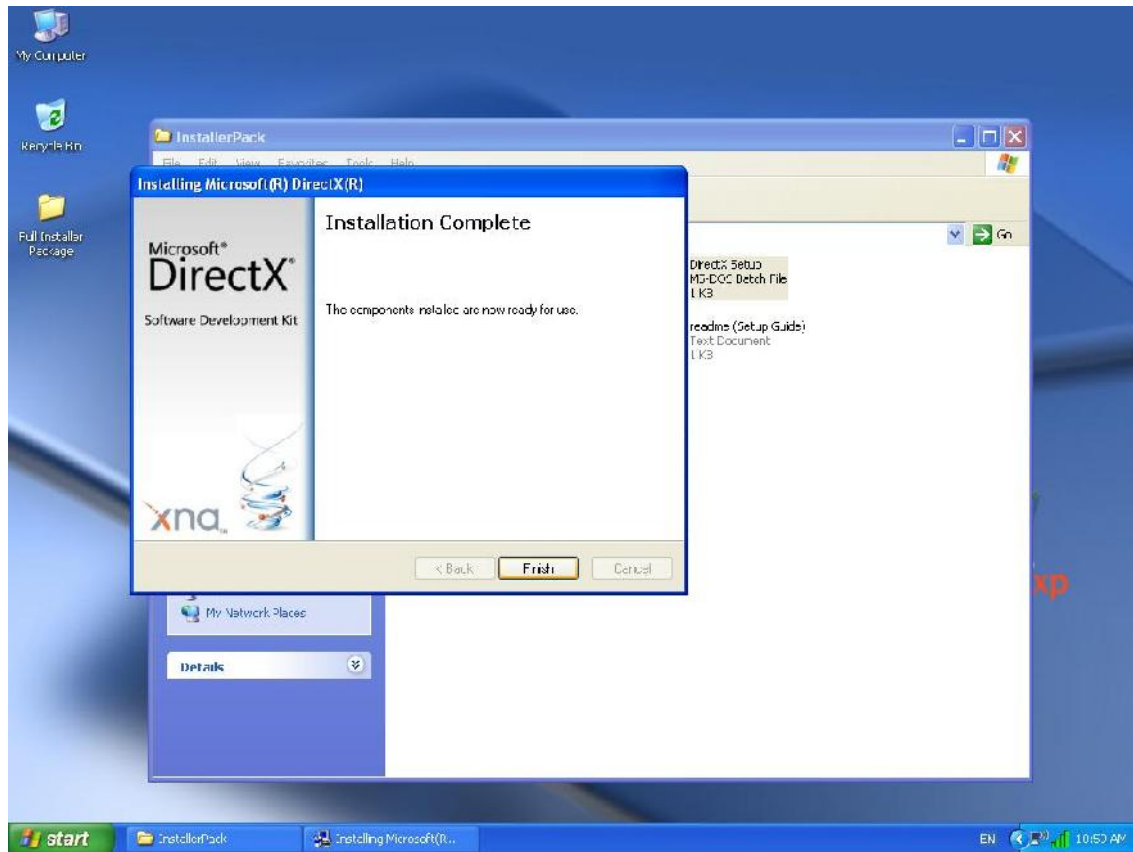

- ***Installation of .Net frame work 3.5***

If the Net Framework was not available in your system, the Net Framework should be installed

Note: most windows 7 (64 bits) have this software, but you need install this software if your computer does not have it

Installing steps:

1. Open the path where the Nr Sign package is available (*NrSign EEG/DotNetFX35/dotnetFX35setup*)
2. Click Accept button to install .Net Framework 3.5

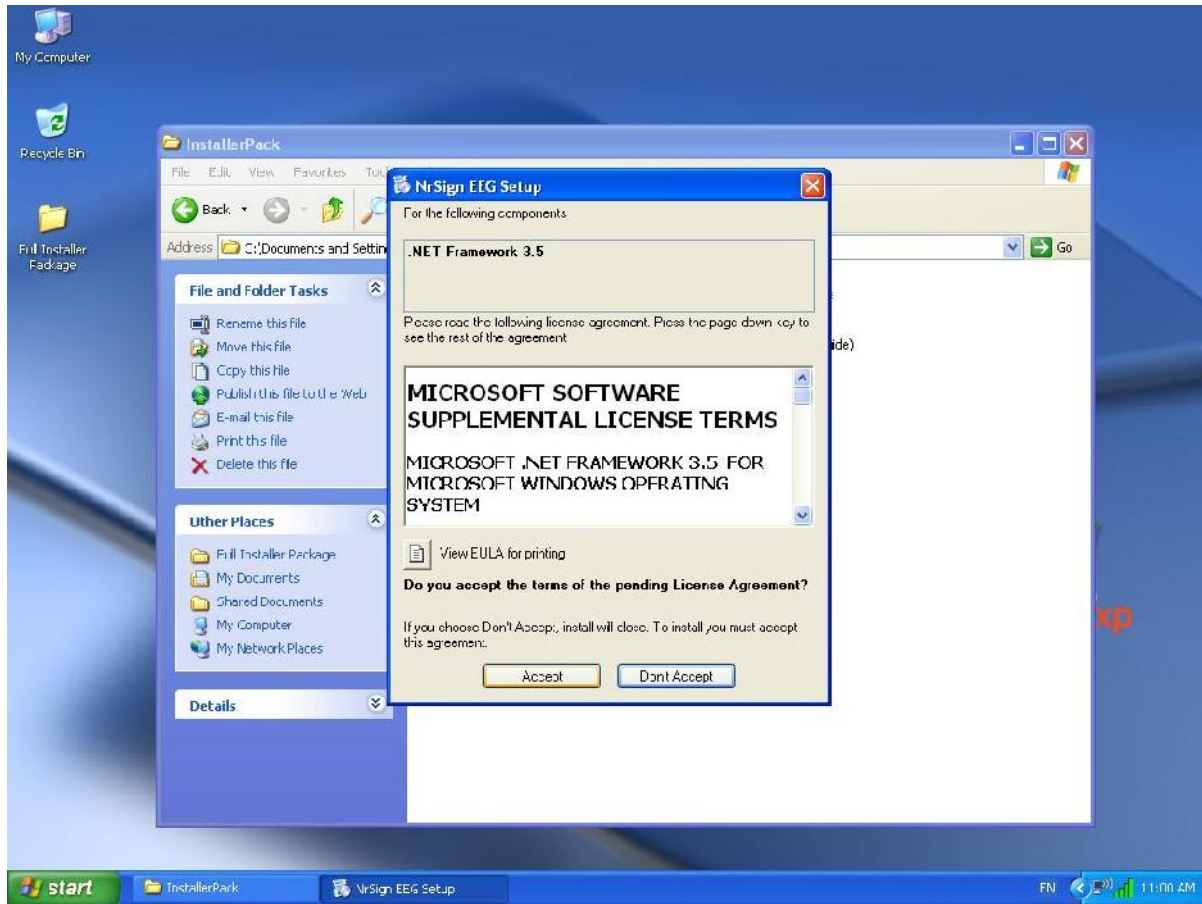

3. Wait for installing .Net Framework 3.5

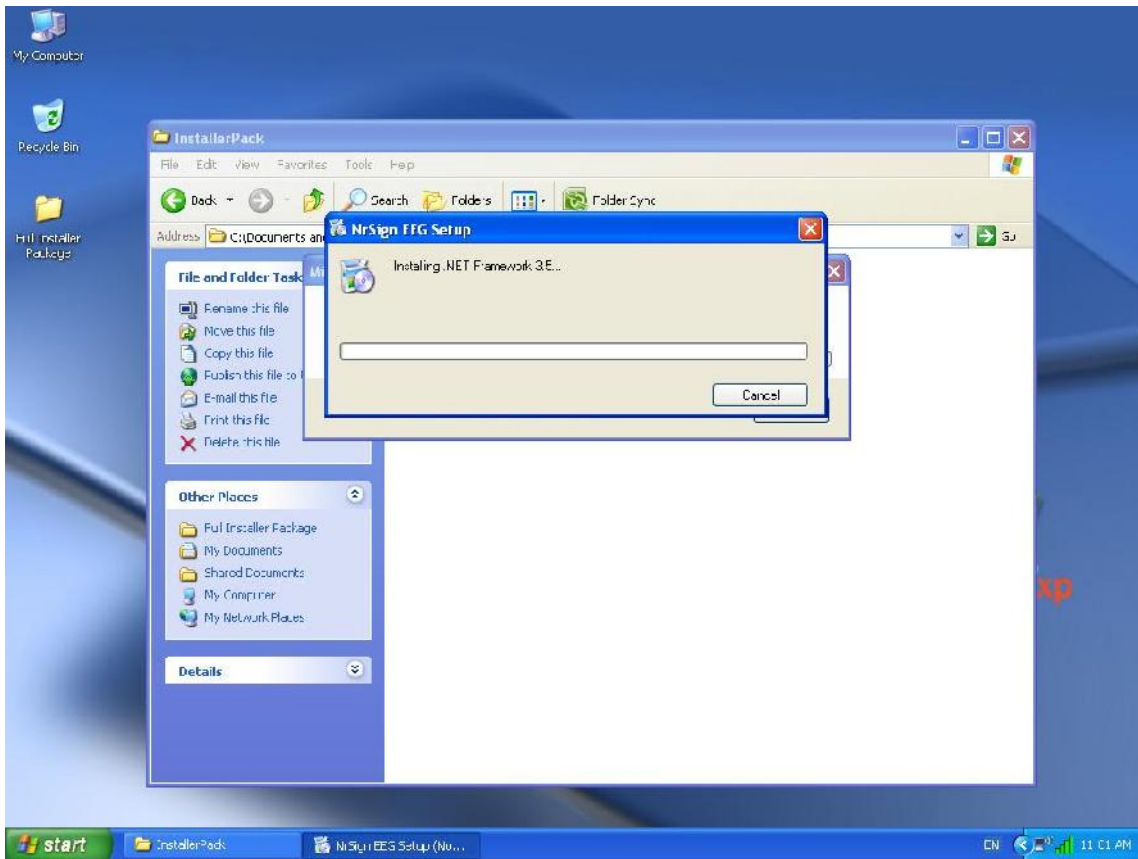

4. Click yes button to reboot the system in order to complete the Net Framework installation.

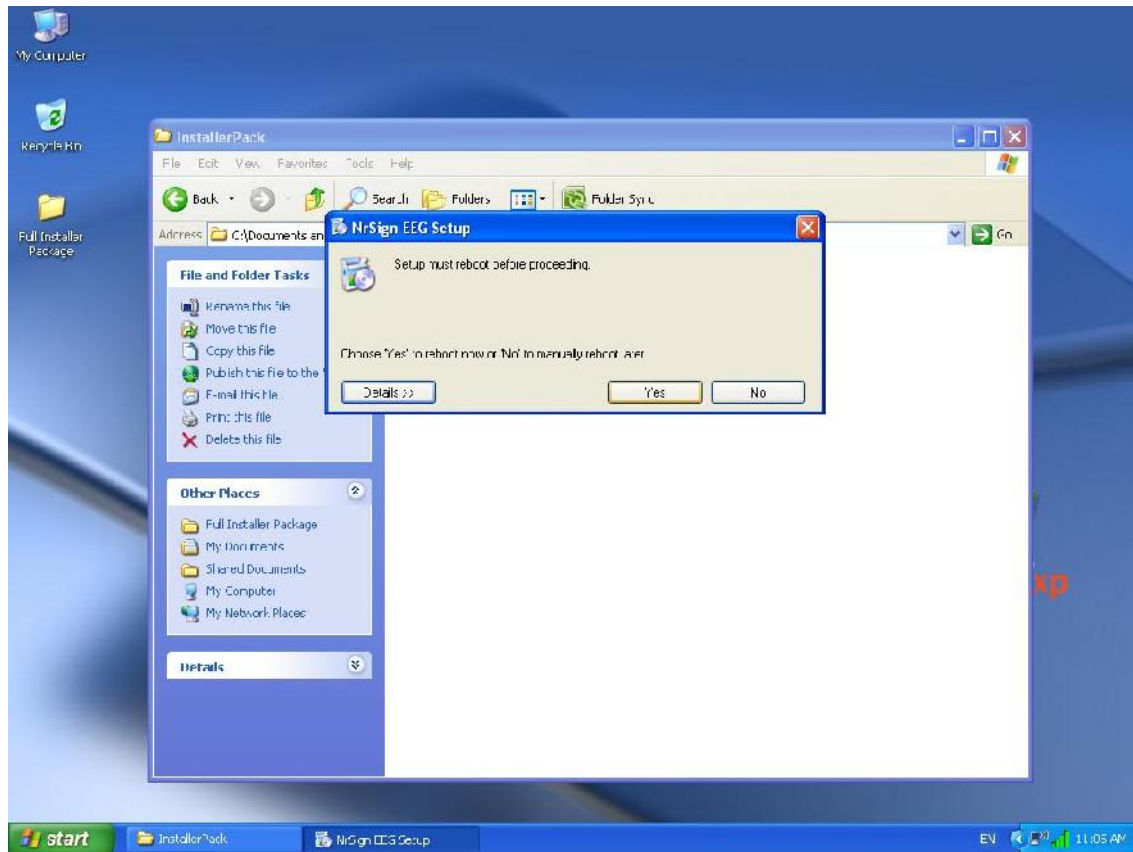

.5. Please wait for the completion of installation

Click the NR SIGN EEG in the NR SIGN software package •

• **Nr Sign EEG first run tips**

After installing the Nr Sign EEG, this application has no database, and you must associate a data base.

After showing the window of Nr Sign EEG first run, please select one of these options.

Option 1: you can connect to the external database (on CD or DVD).

option2: you can connect to the existing database (Ex: on storage device).

Option3: you can create new database.

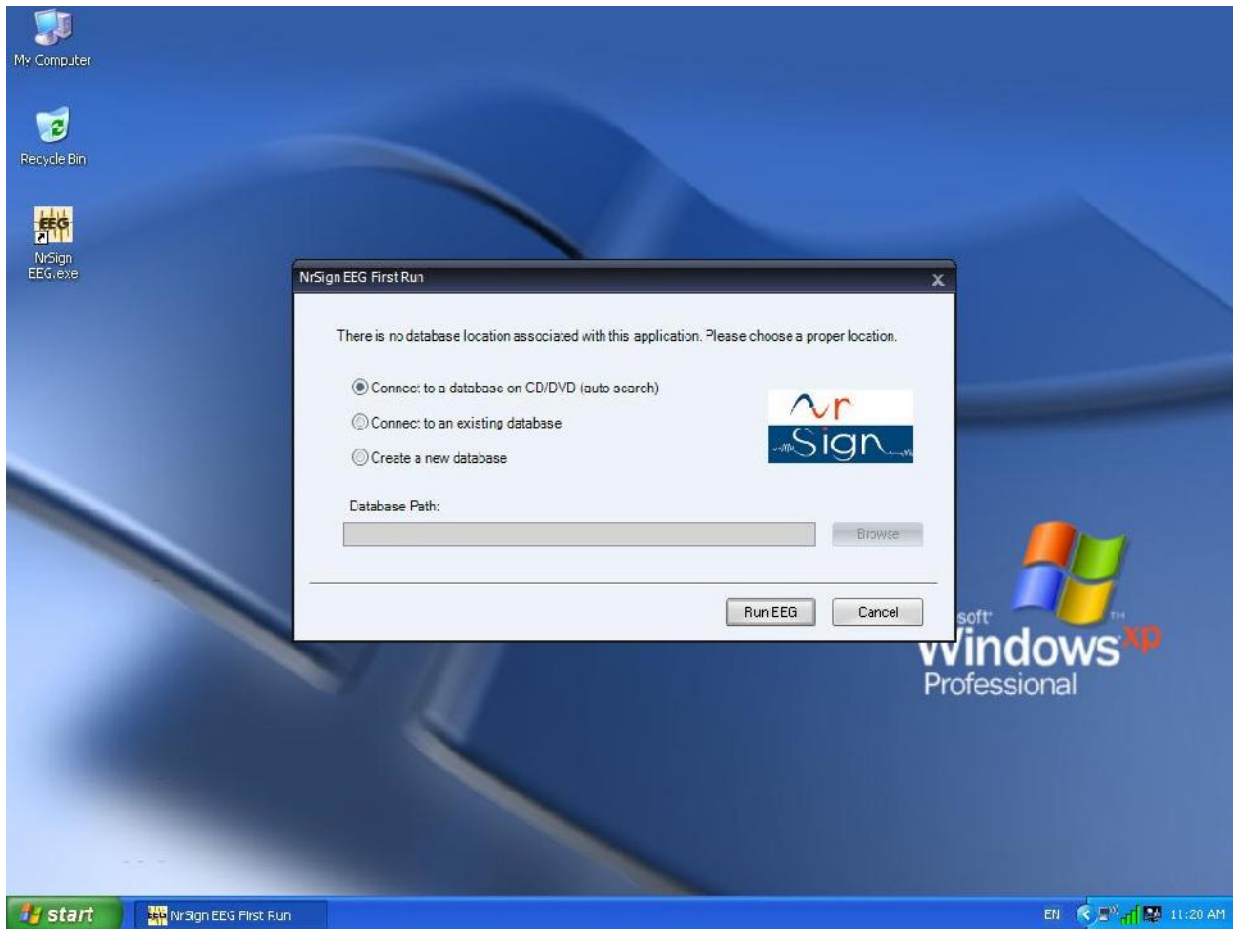

After check one of the selections, please click Browse button and choose the path of your database.

Note: please choose "connect to database on CD/DVD" option if you want review the EEG data from the CD or DVD. Please choose "connect to existing database" if you want connect to previous data base. Please choose "create a new database" if you want to have a new database.

Recommendation: please choose always "create a new database. If you want review the signal from the CD or DVD or an existing a database, please copy it in the hard drive and connect to the desired data base via EEG software.

Please choose the path where there is the more space to create a database.

After choosing the path, please click the Run EEG bottom and enjoy the application.

Your software will not run properly

- 1) make sure you install direct x
- 2) make sure you install framework.net 3.5
- 3) check your software config
 - a. please go to NRSIGN INC/
/CONFIG.txt
 - b. the CONFIG.txt should be

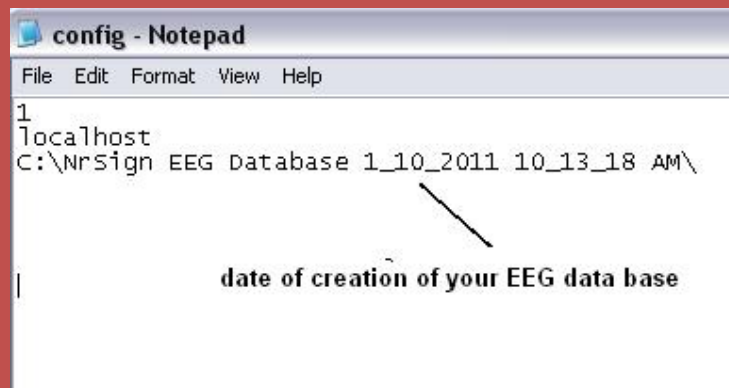

If there is something else please delete the file, and run the EEG NRSIGN icon again, and check this config again.

After installation of the software, the software shall be set up. Please follow these steps:

- a. Please run the software. (double click on NR sign EEG)
- b. Please click on the option bottom on the main screen, this window will appear.

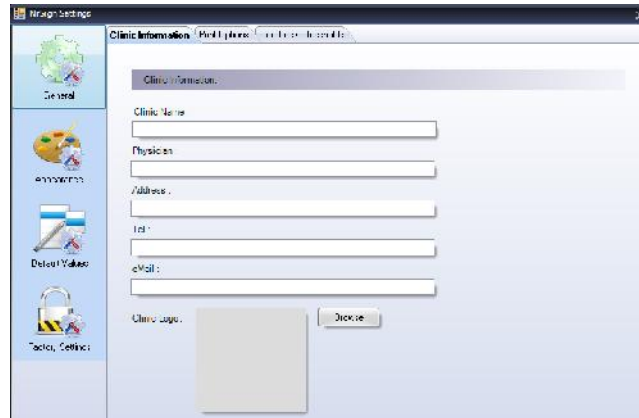

- c. Please click on factory setting. If your system is EEG NRSIGN 3840, please set channel number to 0-31 and choose the 500 sample/second for sample rate, then please choose Head for head box type. The password key is 123. If your system is EEG NR SIGN 5000Q, please set channel number to 0-63 and change your desired sample rate, then please choose Matrix for head box type.

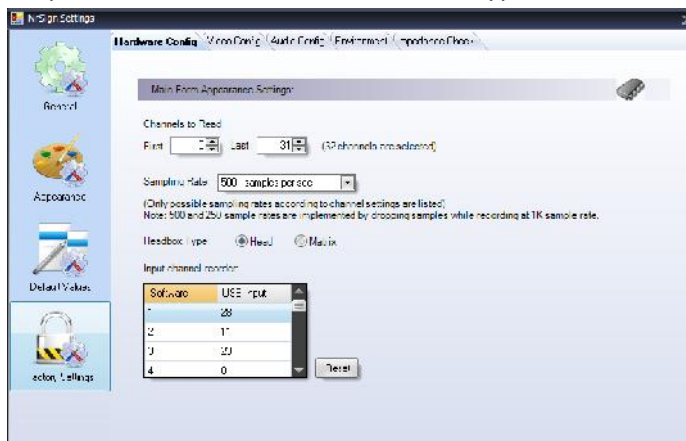

- d. Please choose your notch filter depend on your country power line specification on environment tab.



- e. Please calibrate your monitor by entering monitor's width and Height dimension (millimeter) by a ruler or digital caliper

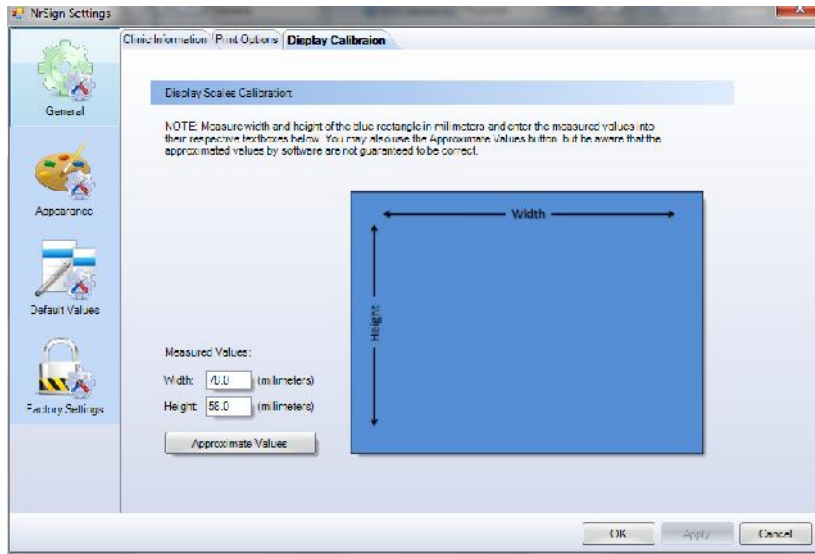

- f. Please click on the VIDEO CONFIG tab and choose your video source. If you chose the IP camera, please enter its IP address which you kept from Axis IP utility (make sure your PC network connector and camera and all cables are fine). Then please chose your IP camera name which usually is Axis M11 series.

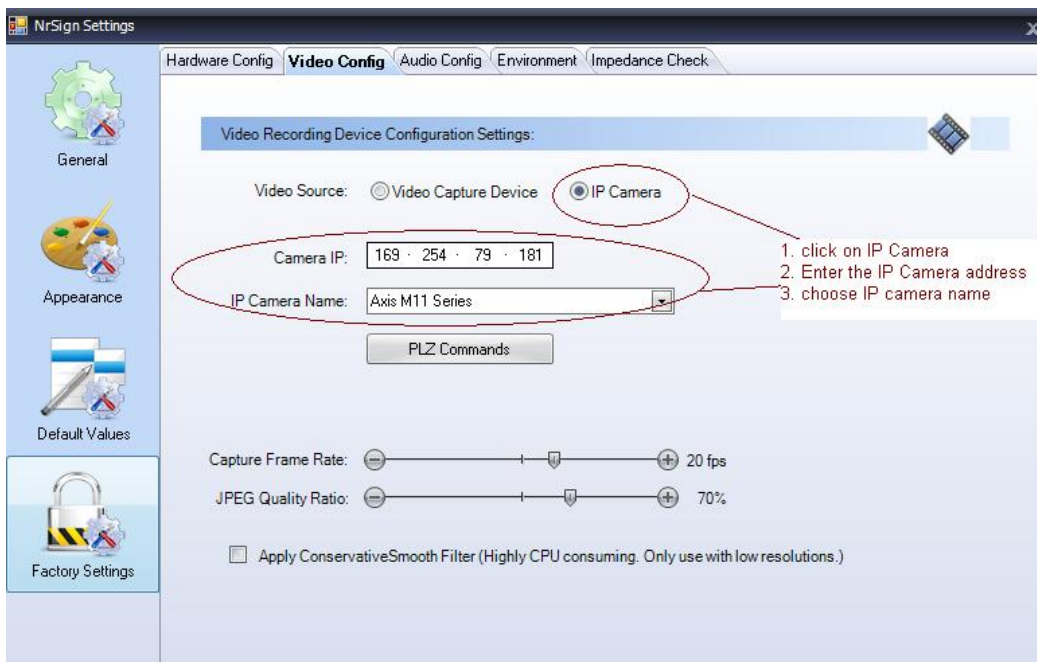

F. Please close the software or exit from the software and open the software again to define your montage figure.

- g. Then please define your desired montage figure in montage manager option. Please read section 5-1(montage editor) for more detail.

- **NRSIGN Software upgrading**

Any new proposed version of NRSIGN software will be announced on our website. Users can upgrade their software by only paying some extra charge to NrSign Manufacturing Co.

Installing Windows updates is up to user, but it is not recommended by NrSign.

Finally, the NRSIGN EEG icon will appear on your computer desk top.

- **Software main screen**

For opening NRSIGN software, double click on NRSIGN software icon on the desktop. Following figure shows the main screen of the software:

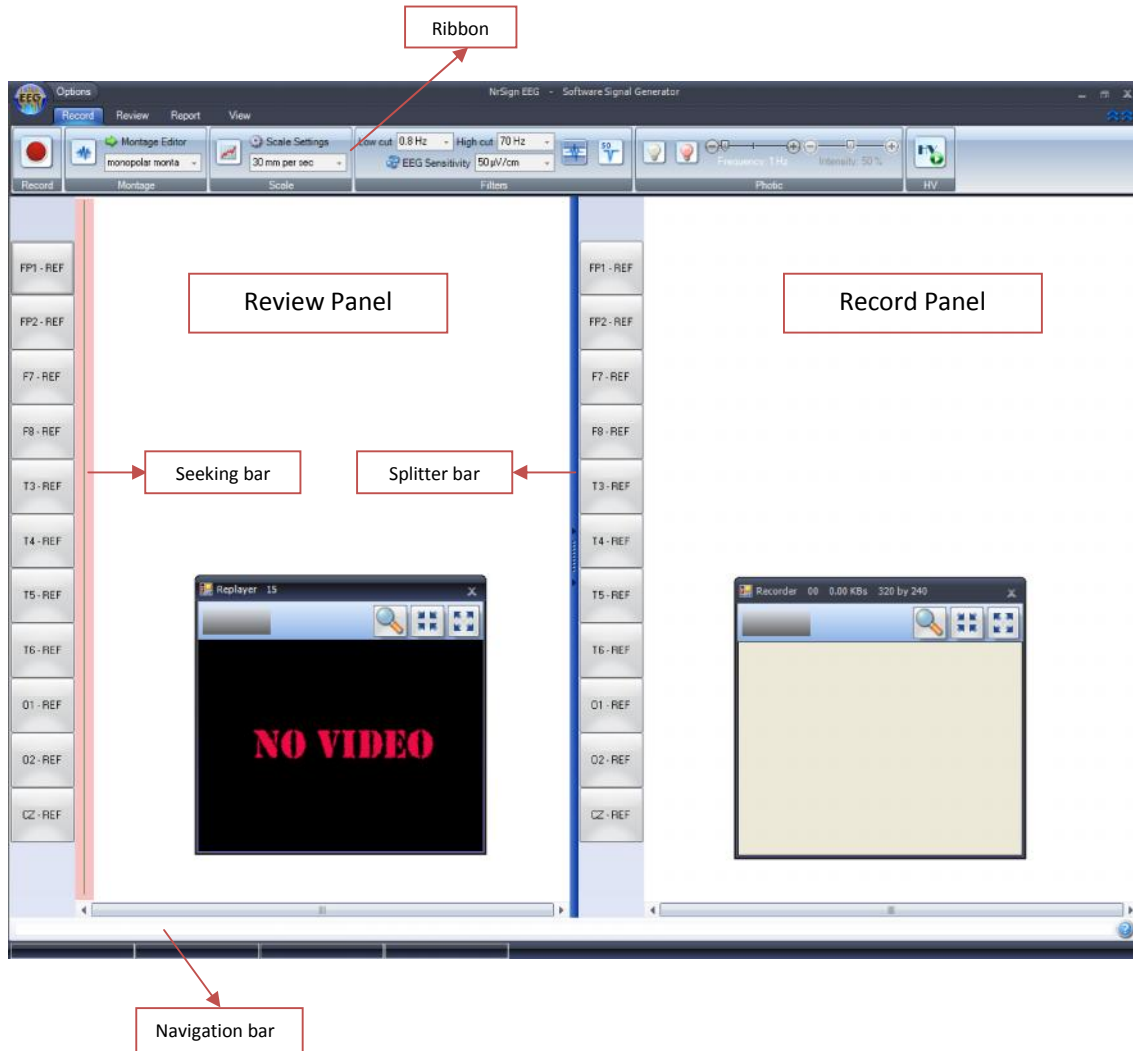

On top of the screen there is a ribbon which contains four tabs: **Record**, **Review**, **View** and **Report**. They're explained in clause 5-8, respectively. The left panel on the screen is review panel and the right panel is record panel. The two video windows for recording and replaying will also be opened when running the software. These two panels are separated by a splitter bar. Beside each of these panels there is a list of the channels in a current montage (for each record or review).

But, keep in mind that from the channel list of both review and record in the main screen you can change some settings which are accessible from montage editor (Please see clause o).

For any changes it is enough for you to select the desired channels by clicking on them, the selected channels have different color and **Bold** text. Then, right click on them the below list is appeared:

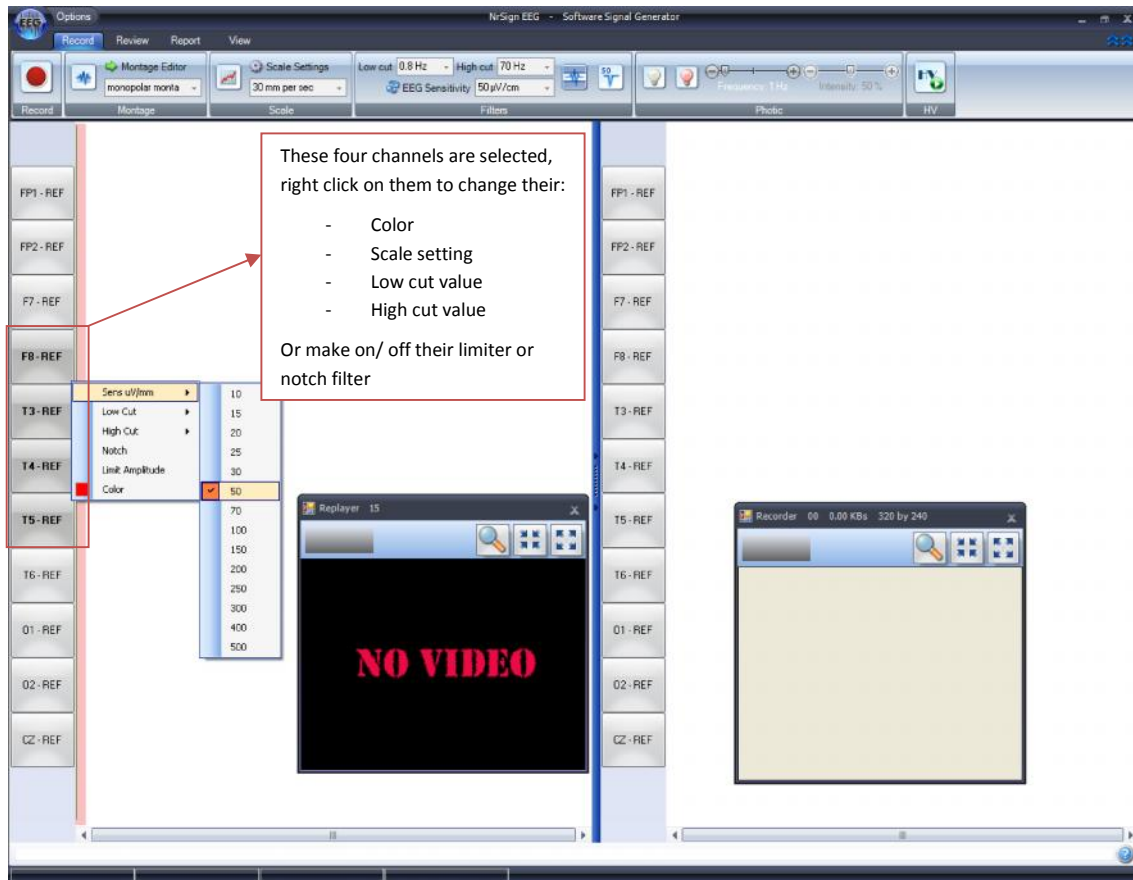

From the list you can change sensitivity, low cut and high cut values of the selected channels. You can also make on/ off notch filter and limiter for the selected channels. And, finally you can select your favorite color for the selected channels.

○ **Software initialization**

It is preferable that User adjust some options prior to system usage. Setting these options can be performed at any other time as well.

For adjusting or changing any prior option setting please select **Options** from title bar or from EEG menu:



Following window will be opened from which you can adjust General Setting, Appearance Setting, Default Values and Factory Settings:

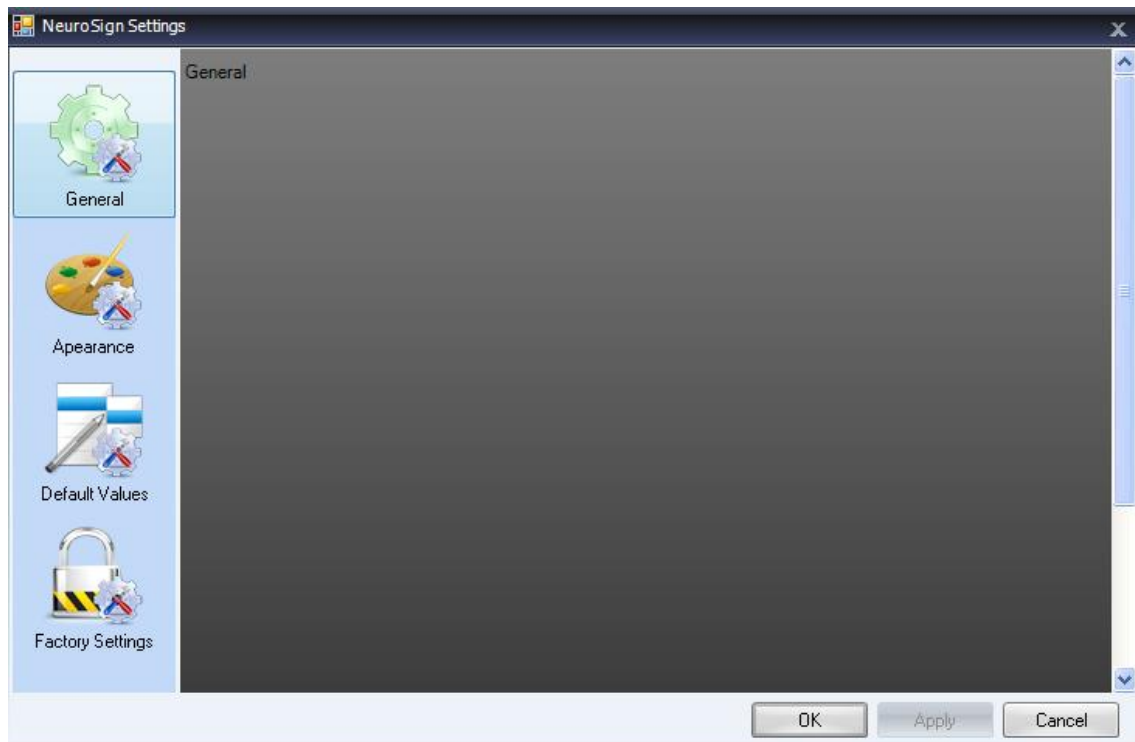

General



Appearance

User can adjust its workspace appearance setting.

Main Form:

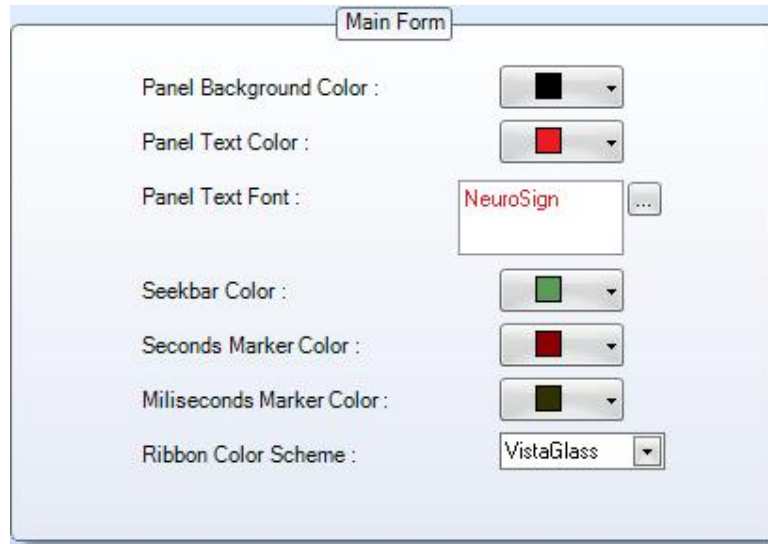

Panel Background Color: The color of background can be chosen according to User taste.

Panel Text Color: Here you can choose the color of the texts on the recording and reviewing Panels.

Panel Text Font: from this part you can adjust Font, Font Style and its size.

Seek bar Color: Color of seeking bar can be adjusted from here.

Second Marker Color: The color of markers used for seconds scale.

Milliseconds Marker Color: The color of markers used for Milliseconds scale.

Ribbon Color Scheme: Ribbon and overall theme color of the software can be adjusted here.

Marks:

Color of Photic, Start-Stop time, HV and Post HV, Annotation and Selection marks, their text color, font size and style can be set accordingly from the following window:

Photic marks setting

- Photic Color : [Red]
- Photic Text Color : [Red]
- Photic Text Font : NrSign

Start-Stop marks setting

- Start-Stop Marker Color : [Black]
- Start-Stop Text Color : [Red]
- Start-Stop Text Font : NrSign

HV marks setting

- HV Color : [Yellow]
- Post HV Color : [Orange]
- HV Text Color : [Red]
- HV Text Font : NrSign

Annotation marks setting

- Annotation Text Color : [Red]
- Annotation Text Font : NrSign

Selection marks setting

- Selection Mark Color : [Green]
- Selection Mark Text Color : [Red]
- Selection Mark Text Font : NrSign



Default Values

Here in this part you can set or change the default values of Scale, High cut, Low cut and also Selection mark and annotation marks defaults. You can define, modify or remove a scale value of both recording and reviewing velocity.

Scale Values

Current Scale Values :

1 sec per page	30 mm per sec
2 sec per page	50 mm per sec
4 sec per page	100 mm per sec
8 sec per page	
10 sec per page	
16 sec per page	
10 mm per sec	
20 mm per sec	

New Scale Value

Modify Selected Value

Remove Selected Value

For defining any new value of sec per page or mm per sec

For modifying any selected value from current scale values

For removing any selected value from current scale values

After defining any new scale value, modify or remove any selected value, confirm your action by click on **Ok**. All applied changes will be appeared in scale menu on toolbar (Please see)

New filters cut off frequencies can be defined from the following boxes. It is also possible for the user to modify or remove any selected frequency from the following boxes.

Highcut Values

Current Highcut Values :

10 Hz	70 Hz
15 Hz	90 Hz
20 Hz	100 Hz
25 Hz	300 Hz
30 Hz	500 Hz
35 Hz	
40 Hz	
50 Hz	

New Highcut Value

Modify Selected Value

Remove Selected Value

For defining a new High cut value

For modifying any selected High cut value

For removing any selected High cut value

Lowcut Values

Current Lowcut Values :

0.05 Hz	2.4 Hz
0.16 Hz	3.0 Hz
0.1 Hz	3.2 Hz
0.5 Hz	5.0 Hz
0.8 Hz	10.0 Hz
1.0 Hz	
1.2 Hz	
1.6 Hz	

New Lowcut Value

Modify Selected Value

Remove Selected Value

For defining a new Low cut value

For modifying any selected Low cut value

For removing any selected Low cut value

After defining any new High cut/ Low cut value, modify or remove any selected value, confirm your action by click on **Ok**. All applied changes will be appeared in Filters menu on toolbar (Please see [ϕ](#) User can mark any selected part of the reviewing signal. Here, you can define some text marks to speed up the reviewing action. Therefore, during reviewing there is no need to write some predefined text marks. By writing one or two character, these default marks will show up (Please see [o](#)). Modifying or removing any selected text mark is possible as well.

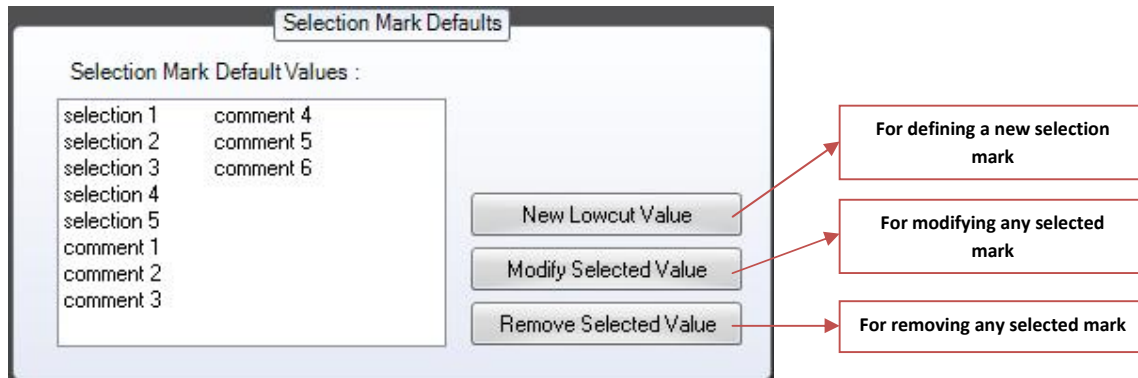

During reviewing signal you can add some annotation on special parts of the signal. These annotations can be defined from the following box:



	Image	Title	Shortkey
1	About	About	A Key
2	Check	Check	B Key
3	Disk	Disk	C Key
4	Error	Error	D Key
5	Forbidden	Forbidden	E Key
6	Gear	Gear	F Key
7	Heart	Heart	G Key
8	Information	Information	H Key
9	Lifebelt	Lifebelt	I Key
10	Music	Music	J Key
11	Recycle	Recycle	K Key
12	Unknown	Unknown	L Key
13	User	User	M Key

For each annotation you can define an A to Z short key. It is also possible for the user to load any image (JPEG type) other than those available in image drop down list.



Factory Settings

Factory settings are password protected. These settings are set by NrSign Manufacturing Co. and can only be changed by an authorized person by NrSign. In some critical situations NrSign will give the password to User. It is highly recommended not to change these settings without consulting NrSign. After performing any changes in these factory settings, you should exit NrSign program and run it another time to make the new changes become default settings of the program.

Following settings are available in factory setting:

Hardware Configuration:

The screenshot shows the 'Hardware Configuration' dialog box. It includes the following elements and callouts:

- Channels to Read:** 'First' and 'Last' spinners are circled in red. A callout box labeled 'Determine number of channels' points to them. The text '(64 channels are selected)' is next to the 'Last' spinner.
- Sampling Rate:** A dropdown menu is set to '1000 samples per sec'. A callout box labeled 'Choosing sample rate' points to it.
- Headbox Type:** Radio buttons for 'Head' and 'Matrix'. 'Matrix' is selected. A callout box labeled 'EEG Monitoring Head box' points to it.
- Input channel reorder:** A table with two columns: 'USB Input' and 'Software'. A callout box labeled 'Define hard code' points to the table.
- Buttons:** 'Reset' button and a hardware component icon.

USB Input	Software
1	24
2	16
3	5
4	22



Note: Never change the hard codes. It may affect the normal function of the system.

Audio settings:

Here you can choose your audio capture device and audio frequency.

The screenshot shows the 'Audio Settings' dialog box with the following fields:

- Capture Device:** Primary Sound Capture Driver
- Device Specification:** (Empty list box)
- Renderer Device:** Primary Sound Driver
- Renderer Specification:** (Empty list box)
- Audio Frequency:** (Empty dropdown menu)

A speaker icon is located at the bottom right of the dialog box.

Environment:

According to the power specification of the installation place, you can choose 50 Hz or 60 Hz notch filter.



o Starting the software

You can run NRSIGN program by double clicking on NrSign icon on the desktop. From EEG menu you can define a new patient, start a new record, load or even close a record. It is also possible to connect to extended package. These are explained in the following:

▪ Define a new patient



New patient

To start a record for a new patient, first you should define a new patient. For this purpose open **EEG** menu and then select **New Patient**:

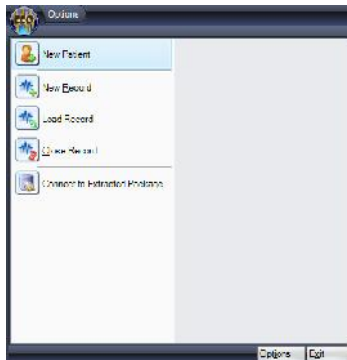

Then, in the following window enter patient necessary information as it is shown on the next figure, and after entering your queries click on **Ok** to confirm them.

The screenshot shows a 'Patient Specification' dialog box with the following fields and annotations:

- First Name:** Nina
- Last Name:** Smith
- Birth Date:** Year, Month, Day (dropdown menus)
- Sex:** Female (button) - Annotation: "Mention patient sex: Male / Female"
- Handedness:** Right (button) - Annotation: "Mention that patient is: Right-handed / Left-handed"
- Last Seizure:** You can enter patient Seizure history here
- Drug History:** You can enter patient drug history here
- Condition of Recording:** Awake (button) - Annotation: "Mention recording condition: Awake / Asleep"
- Special Notes:** You can enter any special note here
- Image:** Patient's Picture (Placeholder) - Annotations: "Browse patient picture if available" (pointing to the 'Browse' button) and "Capture patient picture here" (pointing to the 'Capture' button)
- Buttons:** OK, Cancel

General annotation: "Enter patient personal information" (bracketed on the left side of the form fields)

▪ **Start a new record**



New record

To start a new record for a defined patient choose **New Record** item from EEG menu. Patients' personal information along with their previous records which have been saved in database can be viewed in the following window:

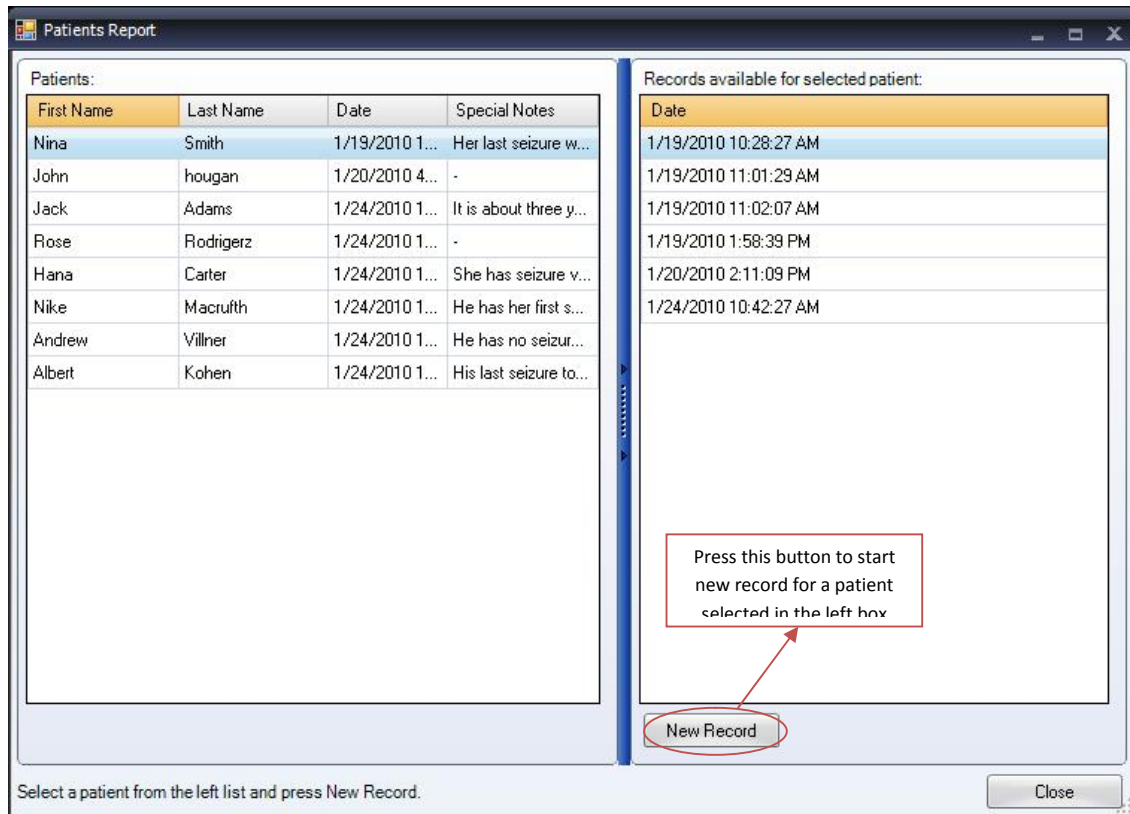

You can sort the lists in alphabetical order of First Name/ Last Name/ Special Notes by clicking on title of each column or sort them chronologically by clicking on the title of Date column. This will speed up your search in finding a specific patient. To start a new record, choose the patient from patient list in left list and then click on **New Record** button.

▪ **Load a record**



Load Record

Patients' personal information along with their previous records is saved in database and can be accessible from **Load Record**. By choosing **Load Record** in **EEG** menu, the following table will be shown.

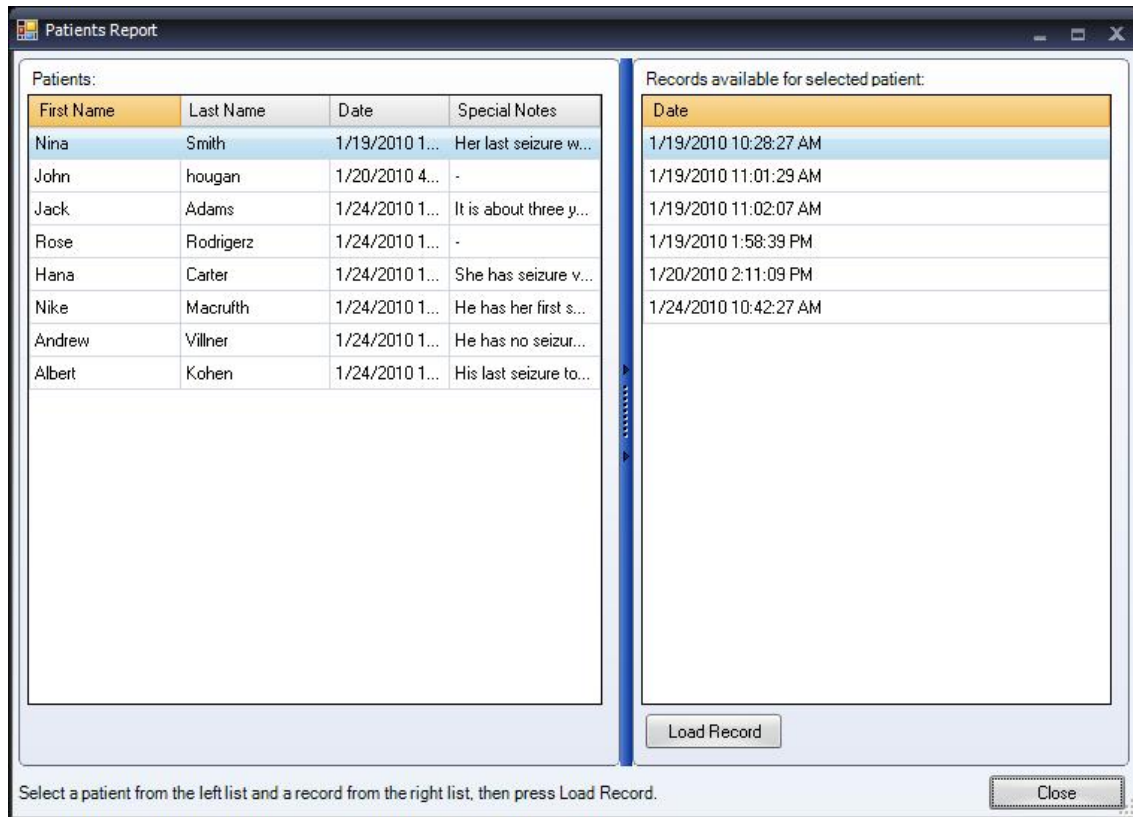

All previous records from different patients are available in this window. In the other word, this window can show you the patient database. By choosing a patient from left list, all his/her previous records will be shown in the right list. You can choose any of them you desire to be loaded.



Note: You can start a new record in the following of any previous desired record. For this purpose first load the desired record as explained above. Then, start recording (See clause **Error! Reference source not found.**). This new record will be automatically saved by new date.

- **Close a record**



Close Record

You can close the present record to start any new action.

- **Connect to extracted package**



Connect to extracted package

Any extracted package you create can be accessed from here. Please see clause 10 to see how you can create a new package.

In the next four chapters the four tabs of the software: **Record**, **Review**, **Report** & **View** are explained. Also, you can find a quick guide for system operation in clause 11.

o Exit of the program software

User can exit the program by clicking on **Exit** in **EEG** menu. Or click on close button on top right side of the page.

• Recording

After creating a new record or load a previously recorded data, you can start recording by clicking on the **Record** icon in **Record** tab.



By clicking on **Record** icon, if the following error box appears it means you do not create a new record or load a previously recorded data.



After starting your record you can stop it at any time by clicking on Stop icon:



○ Montage Editor

You can create, modify or remove a montage through Montage Editor on **Record** tab.

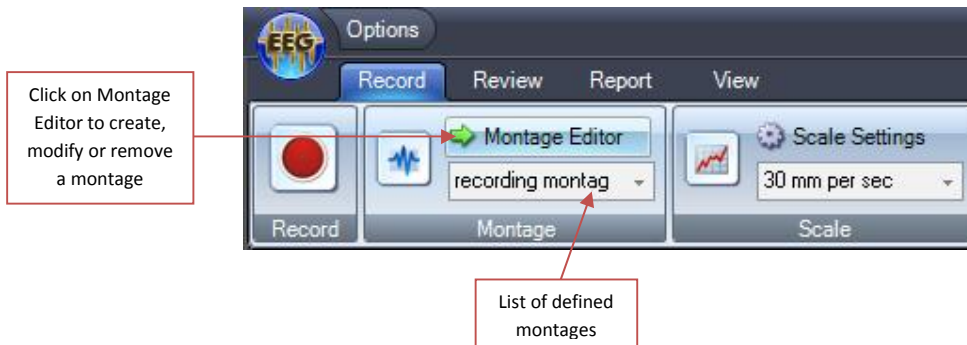

By Clicking on **Montage Editor** the following window will be opened, on which you can see all predefined montages on the left box. On the right box you can see the montage figure. In this picture you can **only** see the position of those electrodes which are according to 10/10 system.

You can create new montage, modify or remove any selected montage from their relevant buttons. These are defined in more details in the following.

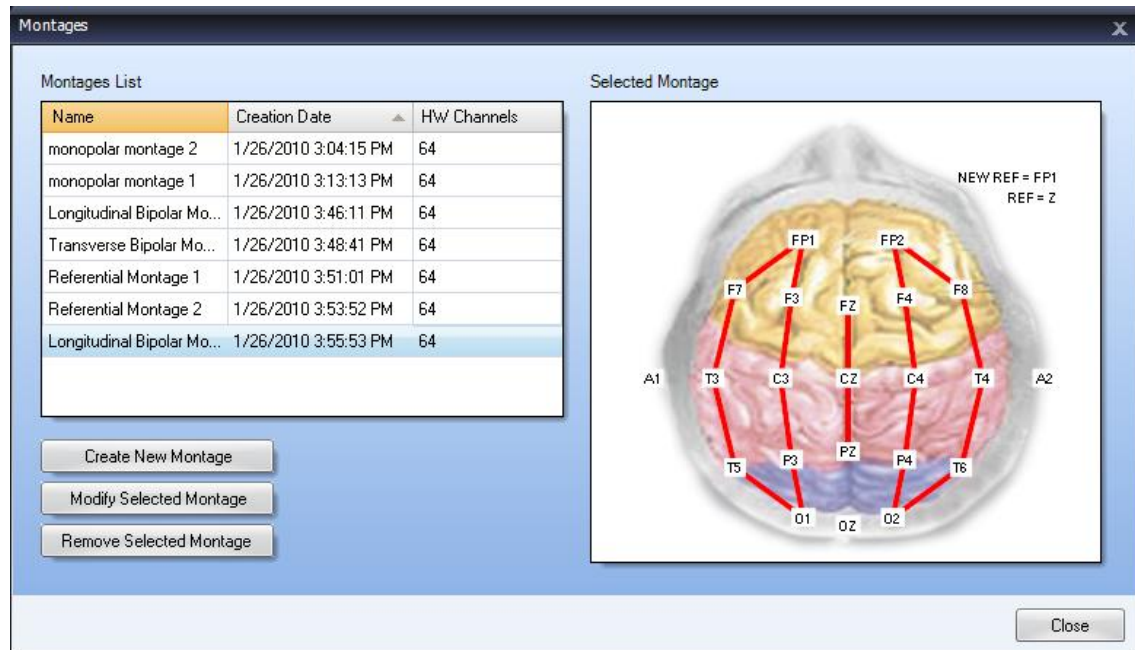

▪ Create a new montage

After clicking on **Create New Montage** button, Montage Editor will be opened.

Montage Name

On top of Montage Editor page you can enter a name for your new montage.

Montage Figure

Those electrode positions which are in accordance with 10/10 system are placed on montage figure. The others are listed in the left side of the window

Channel Table

Any defined channel will be appeared and listed in the channel table on the right side of the page.

Split bar

You can drag the split bar to the right or left to change the size of montage figure or channel table in the Montage Editor page.

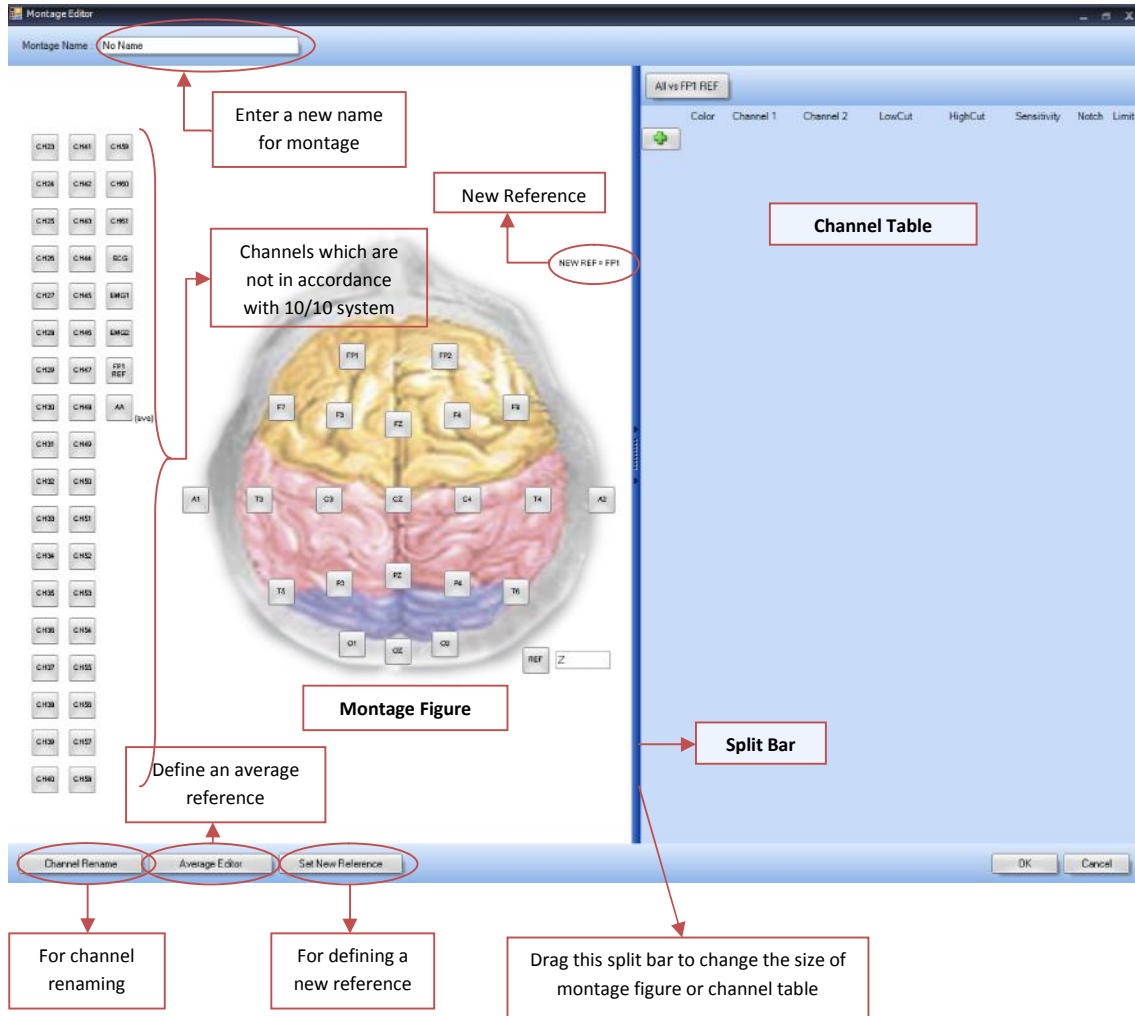

Channel Rename

See Clause

Average Editor

See Clause o

Set New Reference

See Clause o

• Channel Rename

Prior to define any montage you can rename its channels by clicking on **Channel Rename** on Montage Editor. Please pay attention that the content of channel rename page is different for 32 or 64 channel head box. NrSign mentions the type of head box -Matrix 64 ch or Head 32 ch- and the number of channels on Factory setting.



Note: Never change factory setting from 32ch to 64ch. This needs the data base to be dropped down. Therefore, do not do this without consulting NrSign Manufacturing Company.

Head type 32ch head box:

HardwareChannelRenameDlg

CH1 FP1	CH17 A1	CH33 CH33	CH49 CH49
CH2 FP2	CH18 A2	CH34 CH34	CH50 CH50
CH3 F7	CH19 FZ	CH35 CH35	CH51 CH51
CH4 F8	CH20 CZ	CH36 CH36	CH52 CH52
CH5 F3	CH21 PZ	CH37 CH37	CH53 CH53
CH6 F4	CH22 OZ	CH38 CH38	CH54 CH54
CH7 T3	CH23 CH23	CH39 CH39	CH55 CH55
CH8 T4	CH24 CH24	CH40 CH40	CH56 CH56
CH9 C3	CH25 CH25	CH41 CH41	CH57 CH57
CH10 C4	CH26 CH26	CH42 CH42	CH58 CH58
CH11 T5	CH27 CH27	CH43 CH43	CH59 CH59
CH12 T6	CH28 CH28	CH44 CH44	CH60 CH60
CH13 P3	CH29 CH29	CH45 CH45	CH61 CH61
CH14 P4	CH30 CH30	CH46 CH46	CH62 EC6
CH15 O1	CH31 CH31	CH47 CH47	CH63 EMG1
CH16 O2	CH32 CH32	CH48 CH48	CH64 EMG2

Channels can be renamed

10/10 system

Use this button to load channel's name of existing montages

Load channel names from an existing montage

Default

Click on this button will load default name of each channel

OK Cancel

Matrix type 64ch head box:

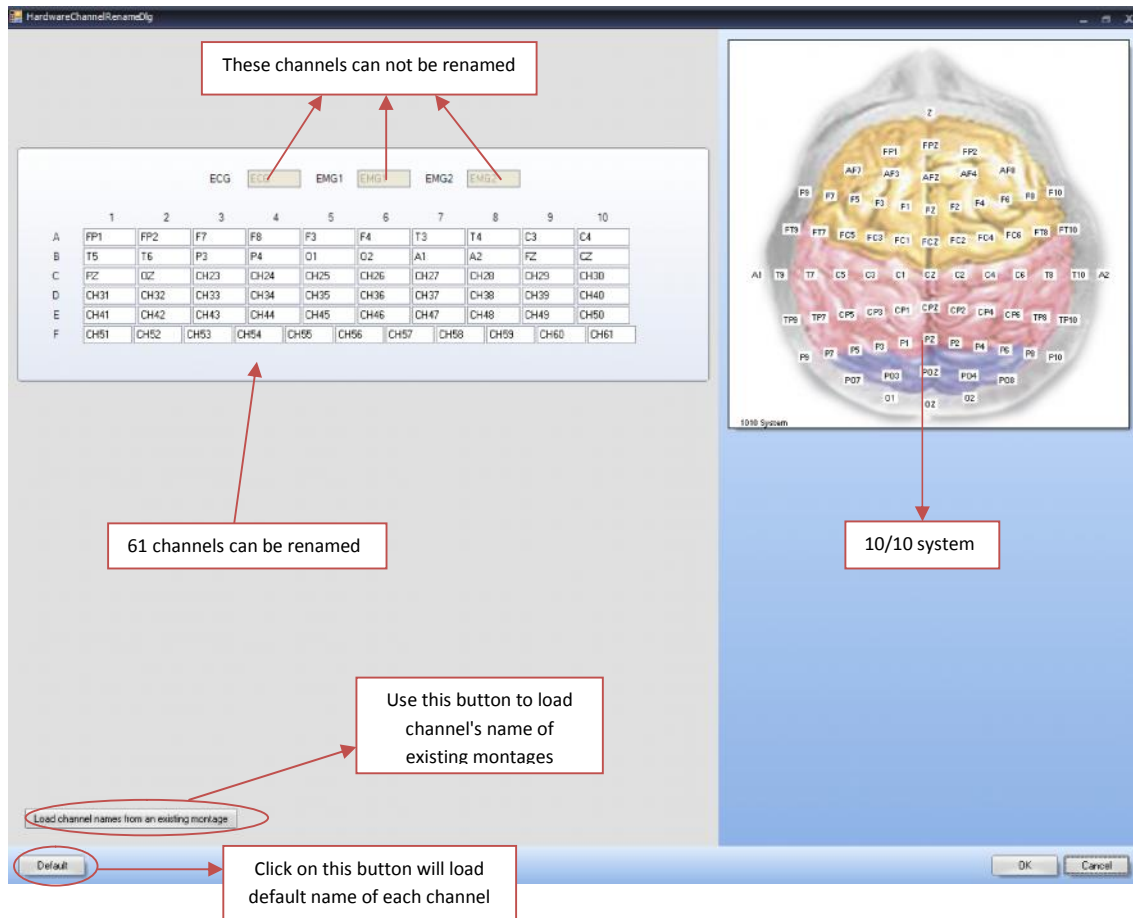

You have three options for channel rename:

1) Use default values

When you open channel rename for the first time each channel default names is available in its relevant boxes. After making any changes on them you can load the default values by click on **Default** button.

2) Load channel names from existing montages

You have an opportunity to use define channel name on some existing montage. In the other word, you can use the same channel name in different montages. Click on **Load channel names from existing montage**, in the following window you can choose each montage to load its channel name. Then click on **Load selected montage channel names**.

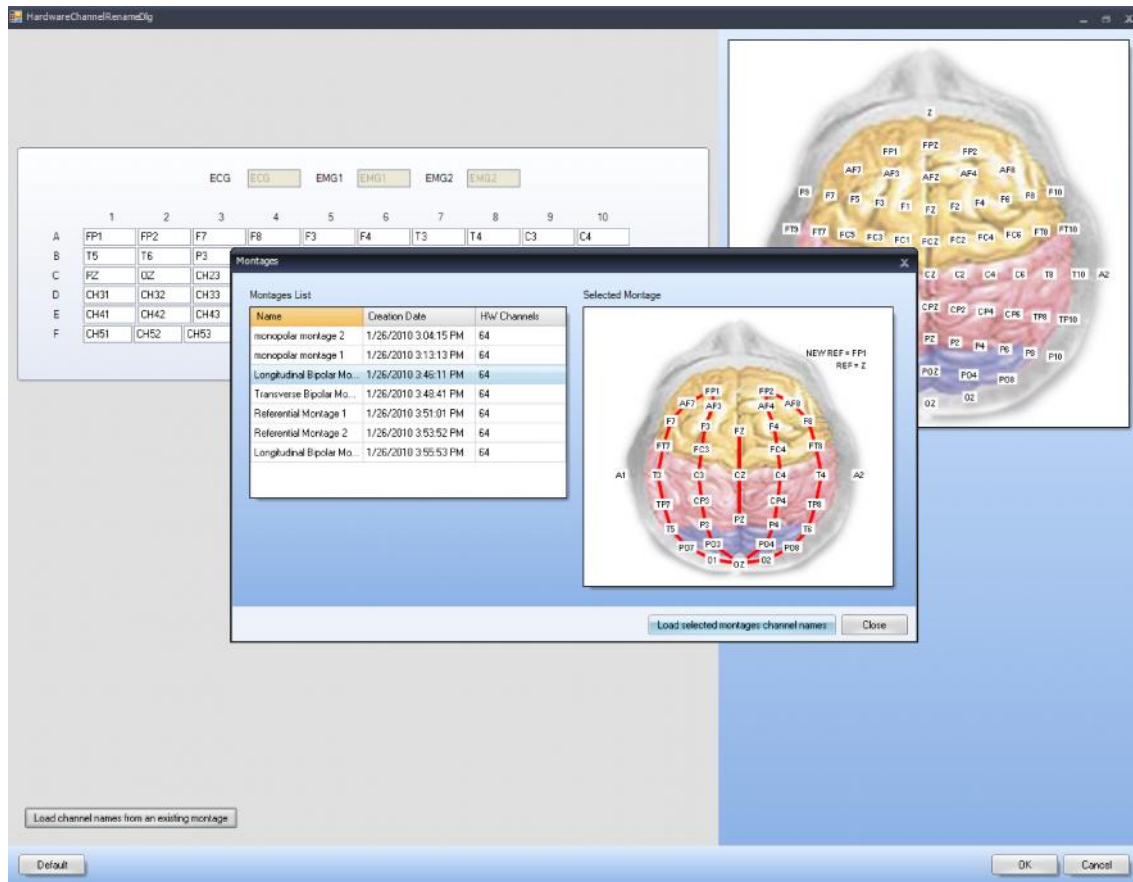

3) Define new values

You can change any defined channel's name by double clicking on its relevant box and entering a new name for it. If you choose the electrode names from 10/10 system, they'll be showed up on montage figure. Among these 64 channels, ECG and EMG channels name are not allowed to be changed.

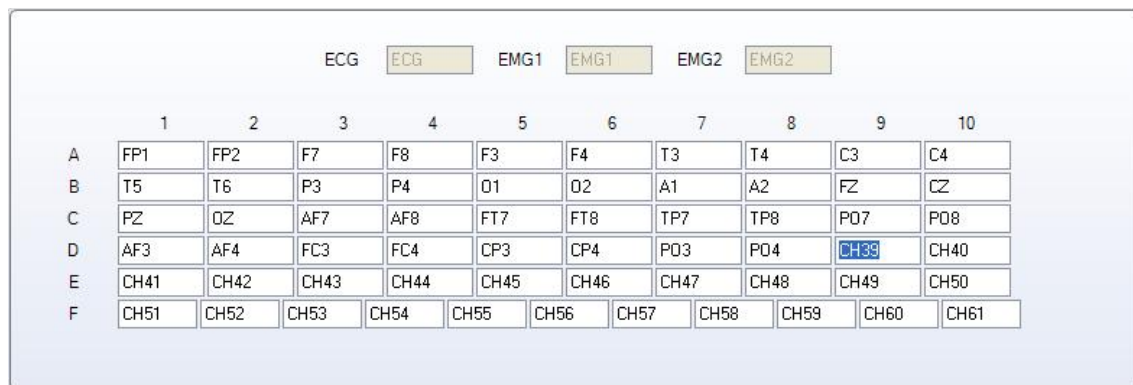

10/10 System:

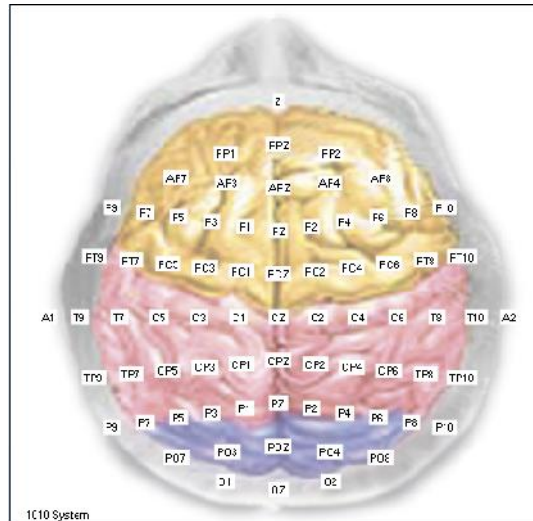

- **Channel define**

Mono Polar Montage

In **mono polar montage**, each channel represents the difference between a certain electrode and designated reference electrode. For defining channels for mono polar montage do the following steps:

1) Define a reference electrode

Recording reference is reference electrode for mono polar montage. The default electrode for recording reference is Z. But, it is possible for you to choose any other electrode as a recording reference on the box next to REF button.

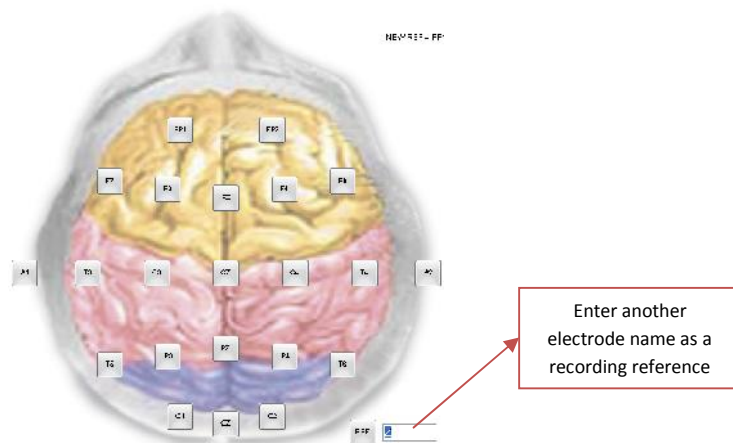

2) Click on REF button

Click on REF button to select the recording reference.

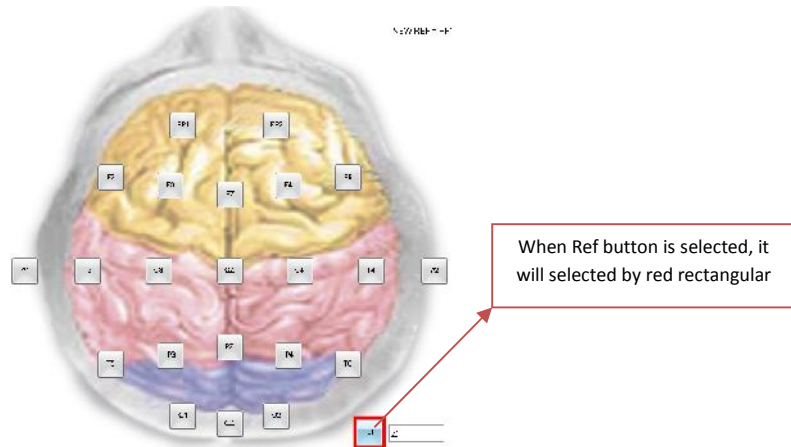

3) Add channel

- a) If you select recording reference, make sure REF button is selected. Now, select any electrode you desire. By click on any electrode, a channel is defined and appeared in a new line of channel table. In mono polar montage the chosen electrode by user will become Channel 1 and REF become Channel 2.

Channel Table

In channel table you have the opportunity to set the values of Low cut, High cut and Sensitivity for each channel. In the other word, here **you can set different settings for each channel**. You can also adjust different color for the channels. Notch filter (50/60 Hz) and limiter can be turned on/ off for each channel you want.

Callouts and their corresponding elements in the table:

- You can set different color for each channel:** Points to the 'Color' column.
- Indicate the number of defined channels:** Points to the channel number (1-15) in the first column.
- Each electrode you select in mono polar montage:** Points to the 'Channel 1' column.
- Channel 2 in mono polar montage is REF:** Points to the 'Channel 2' column.
- You can set different values of Low cut, High cut, Sensitivity for each channel:** Points to the 'LowCut', 'HighCut', and 'Sensitivity' columns.
- Mark each channel you want to turn its notch filter on:** Points to the 'Notch' column.
- Mark each channel you want to turn its limiter on:** Points to the 'Limit' column.

	Color	Channel 1	Channel 2	LowCut	HighCut	Sensitivity	Notch	Limit
1	Red	FP1	REF	0.8 Hz	70 Hz	50 μ V/cm	<input checked="" type="checkbox"/>	<input type="checkbox"/>
2	Yellow	FP2	REF	0.5 Hz	100 Hz	30 μ V/cm	<input checked="" type="checkbox"/>	<input type="checkbox"/>
3	Blue	F7	REF	0.5 Hz	50 Hz	50 μ V/cm	<input checked="" type="checkbox"/>	<input type="checkbox"/>
4	Green	F8	REF	0.8 Hz	70 Hz	30 μ V/cm	<input type="checkbox"/>	<input type="checkbox"/>
5	Purple	T3	REF	0.8 Hz	70 Hz	25 μ V/cm	<input type="checkbox"/>	<input checked="" type="checkbox"/>
6	Light Green	T4	REF	0.8 Hz	70 Hz	25 μ V/cm	<input type="checkbox"/>	<input type="checkbox"/>
7	Dark Blue	T5	REF	0.8 Hz	70 Hz	50 μ V/cm	<input type="checkbox"/>	<input type="checkbox"/>
8	Red	T6	REF	0.8 Hz	70 Hz	50 μ V/cm	<input checked="" type="checkbox"/>	<input type="checkbox"/>
9	Red	O1	REF	0.8 Hz	70 Hz	50 μ V/cm	<input type="checkbox"/>	<input type="checkbox"/>
10	Red	O2	REF	0.8 Hz	70 Hz	50 μ V/cm	<input type="checkbox"/>	<input checked="" type="checkbox"/>
11	Red	CZ	REF	0.8 Hz	70 Hz	50 μ V/cm	<input type="checkbox"/>	<input type="checkbox"/>
12	Red	CH23	REF	0.8 Hz	70 Hz	50 μ V/cm	<input checked="" type="checkbox"/>	<input type="checkbox"/>
13	Red	CH24	REF	0.8 Hz	70 Hz	50 μ V/cm	<input type="checkbox"/>	<input type="checkbox"/>
14	Red	CH29	REF	0.8 Hz	70 Hz	50 μ V/cm	<input type="checkbox"/>	<input type="checkbox"/>
15	Red	CH30	REF	0.8 Hz	70 Hz	50 μ V/cm	<input type="checkbox"/>	<input type="checkbox"/>

Buttons: Add new channel (+), Remove this channel (x)

You can delete each defined channel by click on **Delete** button of each row.

- b) By click on **Add** button you can define a new channel on channel table. Pay attention in this way you should select your desired electrode from Channel 1 list. Also, you should select REF in Channel 2 list. The other setting can be set as explained in part a).

The dropdown menu for Channel 1 is open, showing the following options: FP1, FP2, F7, F8, F3, F4, T3, T4. A callout points to the first option, FP1, with the text "Select first electrode".

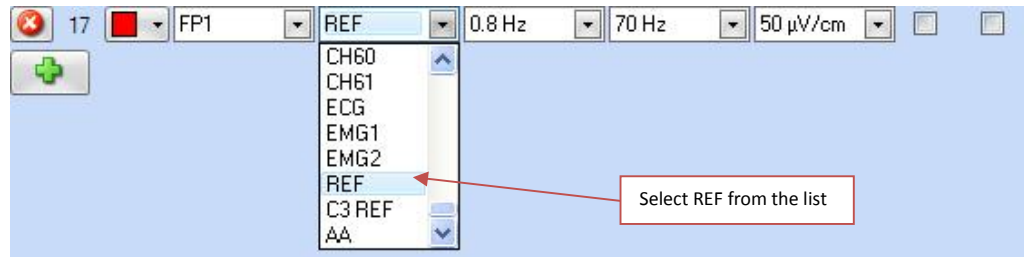

3) Click on Ok

After you have finished adding channels, click on Ok. Make sure you'd chosen appropriate name for your montage. Therefore, this montage will be created and added to montage list in Record Tab.

Bipolar Montage

In **bipolar montage**, each channel represents the difference between two adjacent electrodes (ex. FP1-F7 represents the difference in voltage between the FP1 electrode and the F7 electrode). For defining bipolar montage:

1) Add channel

- a) You can choose electrodes by clicking on each electrode button on montage figure or on those listed in the left side of the page. If both chosen electrodes are selected from 10/10 system a colored line will appear on montage figure which connects the selected electrodes.

Channel Table

In channel table you have the opportunity to set the values of Low cut, High cut and Sensitivity for each channel. In the other word, here **you can set different settings for each channel**. You can also adjust the color of the line which connects the electrodes in each channel differently. Notch filter (50/60 Hz) and limiter can be turned on/ off for each channel you want.

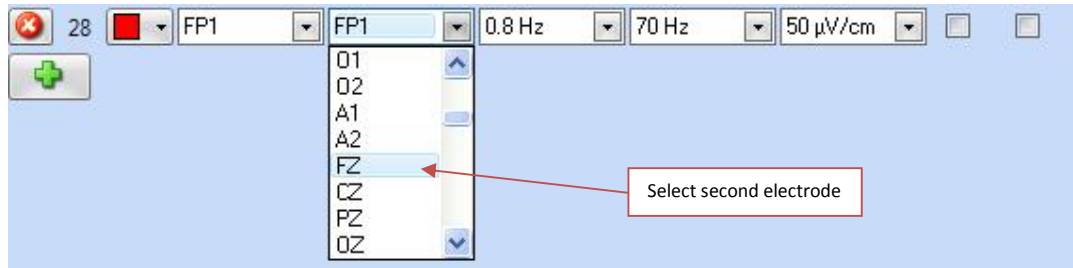

2) Click on Ok

After you have finished adding channels, click on **Ok**. Therefore, this montage will be created and added to montage list in the **Record** Tab.

• Average Editor

You can define a bipolar montage in which channels are defined versus a reference which is a special average of two or more electrodes. For this purpose:

1) Define an average from Average Editor

By click on **Average Editor** in Montage Editor page, Average Creator page will be opened in which you can choose to define a simple average from **Simple Average Editor** tab, or define an average via **Formula Editor** tab on top of the average creator page.

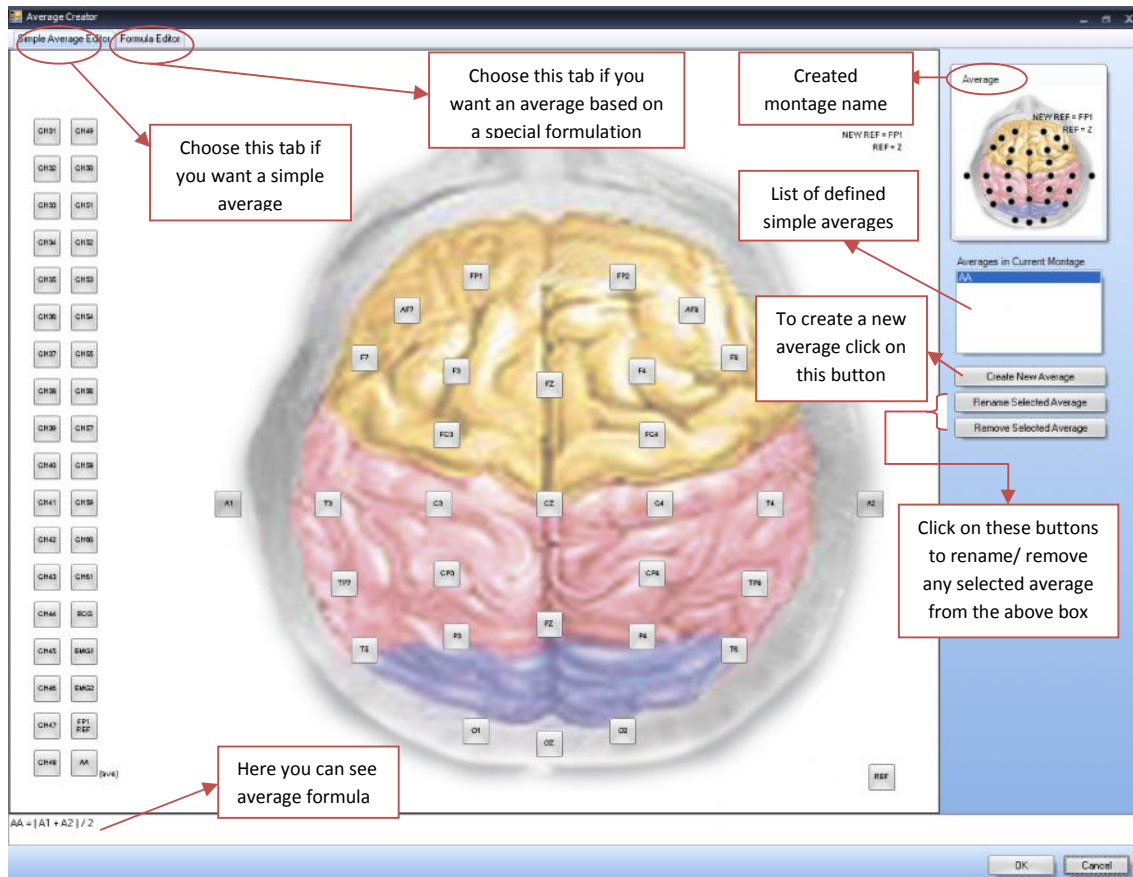

a) Simple Average Editor

In this page, you can see montage figure. On the right side of the page you can see the name of current montage, a box which contains defined averages in current montage, and three buttons for creating a new average, renaming or modifying a selected average from defined average list. This simple average considers arithmetic average of the selected electrodes (Sum of selected electrodes/number of selected electrodes).

There is only one predefined average in the list, **AA**. Which is a the average of A1 and A2 (i.e. $AA = \frac{A_1 + A_2}{2}$).

Create a New Average

After click on **Create New Average** button, a dialog box will be opened which ask you to enter a name for this average.

A dialog box titled "New Average Name :". It contains a text input field with the text "NEW_AVERAGE" entered. Below the input field are two buttons: "OK" and "Cancel".

New Average will be shown on the following box. Select new defined average.

A dialog box titled "Averages in Current Montage". It contains a list box with two items: "AA" and "NEW_AVERAGE". The "NEW_AVERAGE" item is selected and highlighted in blue.

By selecting the desired electrodes, NrSign software automatically calculates their arithmetic average. Its relevant formula will be shown on the bottom of the page. As an example, if you choose FP1, FP2, FZ electrodes the following average will be created:

$$\text{NEW_AVERAGE} = (\text{FP1} + \text{FP2} + \text{FZ}) / 3$$

Then, click on **Ok** to save this new average. A new button  (ave) will be added to left side of the montage figure which represents this new defined average.

Rename Selected Average

After click on **Rename Selected Average** button, a dialog box will be opened which ask you to enter a new name for this average. After entering a new name, click on Ok. The new name will be shown on the box.

A dialog box titled "New Average Name :". It contains a text input field with the text "NEW_AVERAGE" entered. Below the input field are two buttons: "OK" and "Cancel".

Remove Selected Average

After click on **Remove Selected Average** button, a dialog box will be opened which confirms removing this average. After click on Ok, this average will not exist on the box.

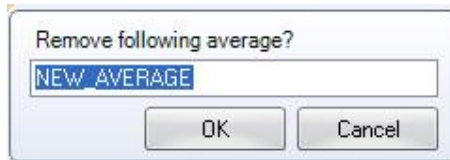

b) Formula Editor

Select Formula Editor Tab, if you want to define a new average based on a formula. On the right side of the page you can see the name of current montage, a box which contains formula in current montage, and three buttons for creating a new formula, renaming or modifying a selected formula from the list. There is also a simple calculator by which you can enter a number or math symbols.

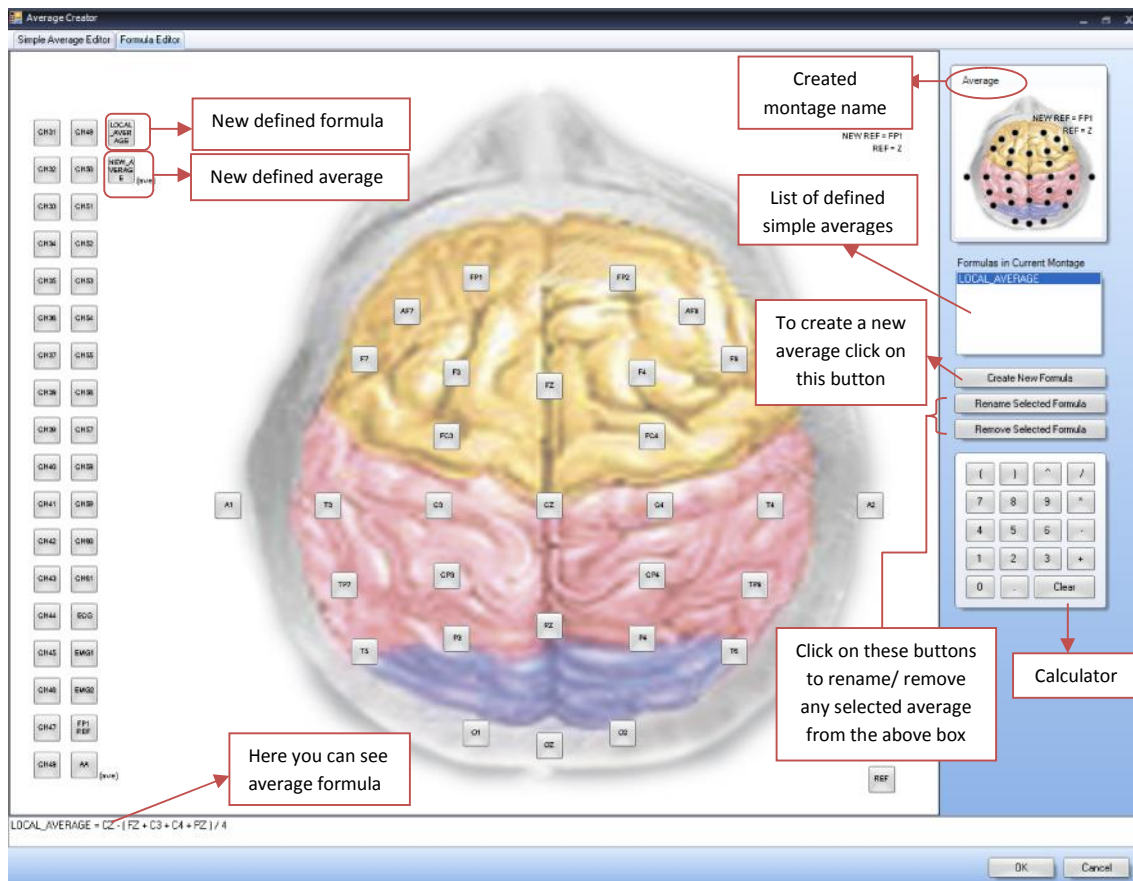

Create New Formula

After click on **Create New Formula** button, a dialog box will be opened which ask you to enter a name for this formula.

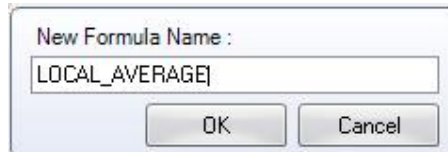

A dialog box titled "New Formula Name:" with a text input field containing "LOCAL_AVERAGE" and two buttons: "OK" and "Cancel".

New formula will be shown on the following box. Select new defined formula.

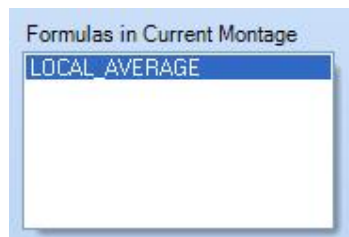

A list box titled "Formulas in Current Montage" with "LOCAL_AVERAGE" selected and highlighted in blue.

You can define any mathematical formula of the desired electrodes by using the calculator on the page. Its relevant formula will be shown on the bottom of the page. As an example, if you want to have a local average of CZ:

$$\text{LOCAL_AVERAGE} = \text{CZ} - (\text{FZ} + \text{C3} + \text{C4} + \text{PZ}) / 4$$

Then, click on **Ok** to save this new formula. A new button  will be added to left side of the montage figure which represents this new defined formula.

Rename Selected Formula

After click on **Rename Selected Formula** button, a dialog box will be opened which ask you to enter a new name for this formula. After entering a new name, click on Ok. The new name will be shown on the box.



A dialog box titled "New Formula Name:" with a text input field containing "LOCAL_AVERAGE" and two buttons: "OK" and "Cancel".

Remove Selected Formula

After click on **Remove Selected Formula** button, a dialog box will be opened which confirms removing this Formula. After click on Ok, this average will not exist on the box.

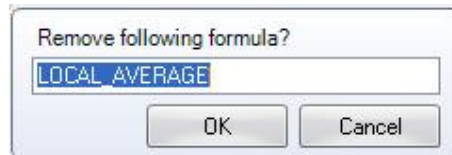

2) Add Channel

- a) After you set an average by one of the described methods, a new relevant button will be created on the left side of the page. You can start adding channels by click on each electrode you want and then click on this new reference button on the left side of the page. New defined channel will be showed on channel table on the right side of the page.

Channel Table

In channel table you have the opportunity to set the values of Low cut, High cut and Sensitivity for each channel. In the other word, here ***you can set different settings for each channel***. You can also adjust different color for each channel. Notch filter (50/60 Hz) and limiter can be turned on/ off for each channel you want.

Callouts for the channel configuration table:

- You can set different color for each channel
- Indicate the number of defined channels
- Each electrode you select in mono polar montage
- Select one of the defined averages as Channel 2
- You can set different values of Low cut, High cut, Sensitivity for each channel
- Mark each channel you want to turn its notch filter on
- Mark each channel you want to turn its limiter on
- Add new channel
- Remove this channel

	Color	Channel 1	Channel 2	LowCut	HighCut	Sensitivity	Notch	Limit
1	Blue	FP1	NEW_AVE	0.8 Hz	70 Hz	50 μ V/cm	<input type="checkbox"/>	<input type="checkbox"/>
2	Red	FP2	NEW_AVE	0.5 Hz	90 Hz	70 μ V/cm	<input checked="" type="checkbox"/>	<input checked="" type="checkbox"/>
3	Green	F3	NEW_AVE	1.0 Hz	50 Hz	30 μ V/cm	<input type="checkbox"/>	<input type="checkbox"/>
4	Yellow	F4	NEW_AVE	0.8 Hz	90 Hz	50 μ V/cm	<input checked="" type="checkbox"/>	<input type="checkbox"/>
5	Cyan	FC3	NEW_AVE	0.5 Hz	70 Hz	50 μ V/cm	<input type="checkbox"/>	<input checked="" type="checkbox"/>
6	Purple	FC4	NEW_AVE	0.8 Hz	70 Hz	50 μ V/cm	<input type="checkbox"/>	<input type="checkbox"/>
7	Orange	C3	NEW_AVE	0.8 Hz	70 Hz	50 μ V/cm	<input type="checkbox"/>	<input type="checkbox"/>
8	Red	C4	NEW_AVE	0.8 Hz	70 Hz	50 μ V/cm	<input type="checkbox"/>	<input type="checkbox"/>
9	Red	CP3	NEW_AVE	0.8 Hz	70 Hz	50 μ V/cm	<input type="checkbox"/>	<input type="checkbox"/>
10	Red	CP4	NEW_AVE	0.8 Hz	70 Hz	50 μ V/cm	<input type="checkbox"/>	<input type="checkbox"/>
11	Red	P3	NEW_AVE	0.8 Hz	70 Hz	50 μ V/cm	<input type="checkbox"/>	<input type="checkbox"/>
12	Red	P4	NEW_AVE	0.8 Hz	70 Hz	50 μ V/cm	<input type="checkbox"/>	<input type="checkbox"/>
13	Red	O1	NEW_AVE	0.8 Hz	70 Hz	50 μ V/cm	<input type="checkbox"/>	<input type="checkbox"/>
14	Red	O2	NEW_AVE	0.8 Hz	70 Hz	50 μ V/cm	<input type="checkbox"/>	<input type="checkbox"/>

- b) By click on **Add** button  you can define a new channel on channel table. Pay attention in this way you should select the desired electrode in first channel from Channel 1 and then the defined average from Channel 2 list. The other settings can be set as explained in part a).

Close-up of the 'Add new channel' dialog box:

- Channel 1 dropdown: FP1
- Channel 2 dropdown: FP1
- LowCut: 0.8 Hz
- HighCut: 70 Hz
- Sensitivity: 50 μ V/cm
- Notch:
- Limit:
- Electrode list: FP1, FP2, F7, F8, F3, F4, T3, T4
- Callout: Select first electrode

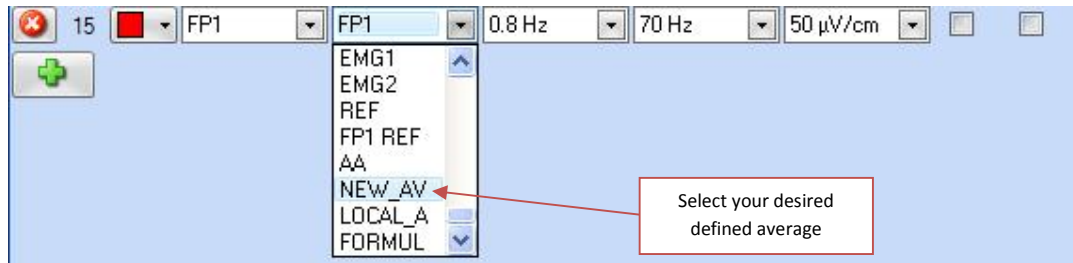

3) Click on Ok

After you have finished adding channels, click on Ok. Make sure you'd chosen appropriate name for your montage. Therefore, this montage will be created and added to montage list in Record Tab.

• Set New Reference

You can define a bipolar montage in which all channels are defined versus a special REF. For this purpose:

1) Define a reference through Set New Reference button.

By click on **Set New Reference** button in Montage Editor, the following page will be opened. Select an electrode position as a reference. You can see the name of this new reference on top right side of the page. Then click on **Ok**.

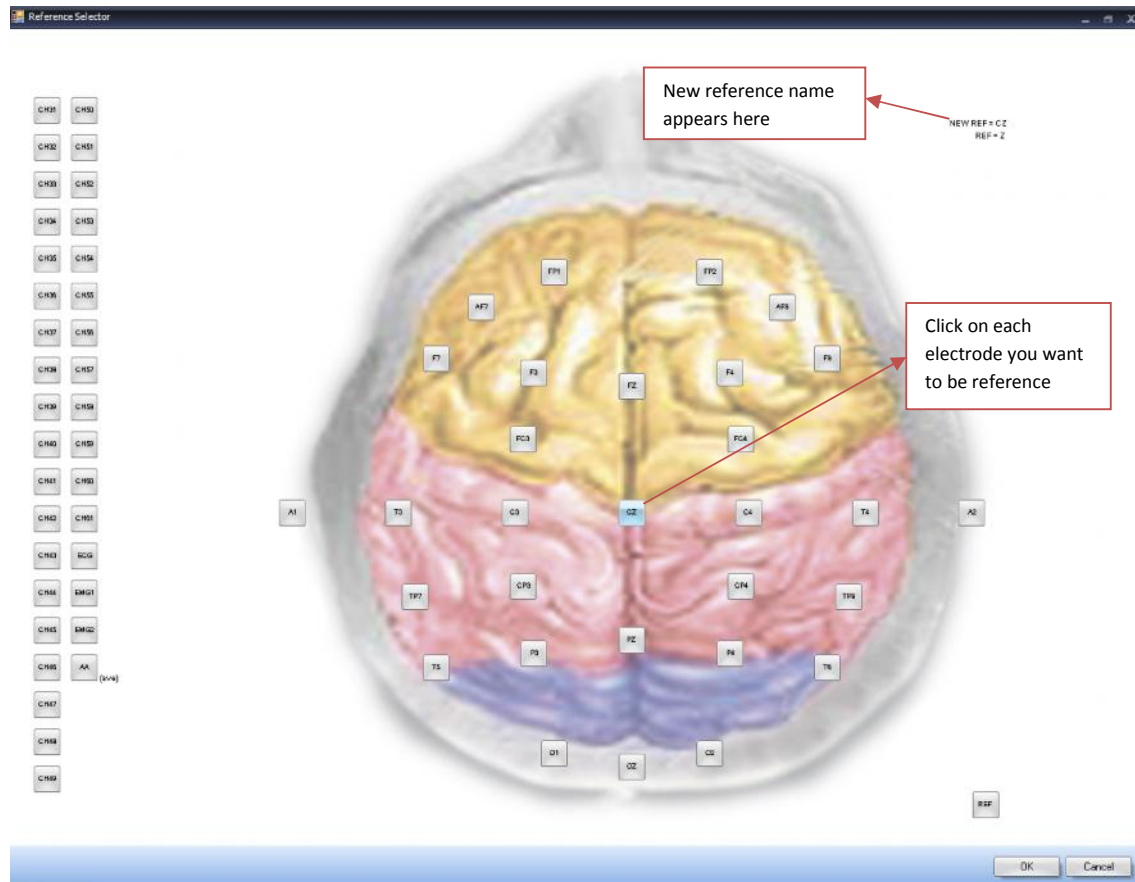



2) Add channel

- a) After you set a new reference, a new button will be created on the left side of the page. You can start adding channels by click on each electrode you want and then click on this new REF button on the left side of the page. New defined channel will be showed on channel table on the right side of the page.

Channel Table

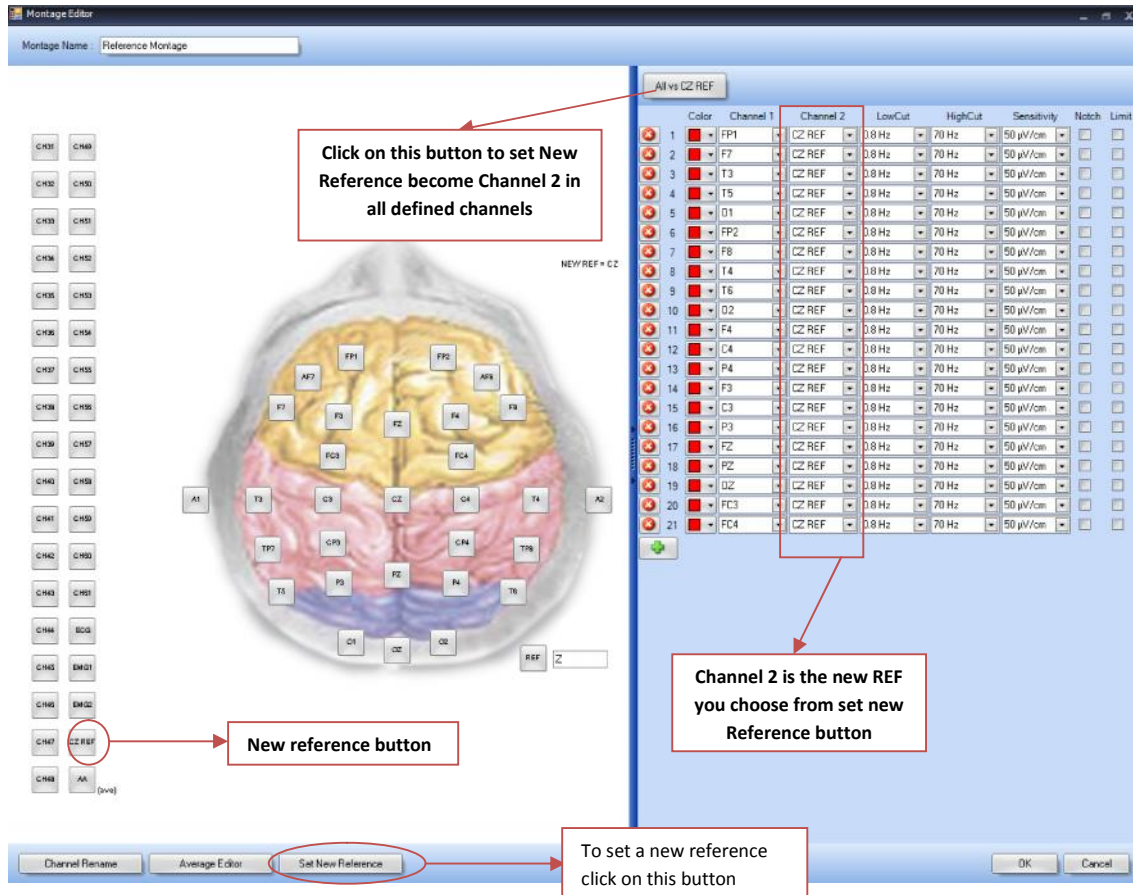
In channel table you have the opportunity to set the values of Low cut, High cut and Sensitivity for each channel. In the other word, here ***you can set different settings for each channel***. You can also adjust different colors for the channels. Notch filter (50/60 Hz) and limiter can be turned on/ off for each channel you want.

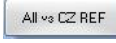

- b) By click on **Add** button  you can define a new channel on channel table. Pay attention in this way you should select both desired electrodes in each channel from Channel 1 and Channel 2 list. Or, only select desired electrode on Channel 1 and then click on  button. This makes all channels have new reference for their Channel 2. The other settings can be set as explained in part a).

3) Click on Ok

After you have finished adding channels, click on Ok. Make sure you'd chosen appropriate name for your montage. Therefore, this montage will be created and added to montage list in Record Tab.

▪ Modify selected montage

If you want to modify the created montage, select the desired one from the list and then click on Modify Selected Montage. Montage editor page will open and you can make any changes you desire.

▪ **Remove selected montage**

If you want to remove any of the created montages, select the desired one from the list and then click on Remove Selected Montage. A dialog box will be appeared to make sure about deleting the selected montage. By click on OK the selected montage will be deleted.

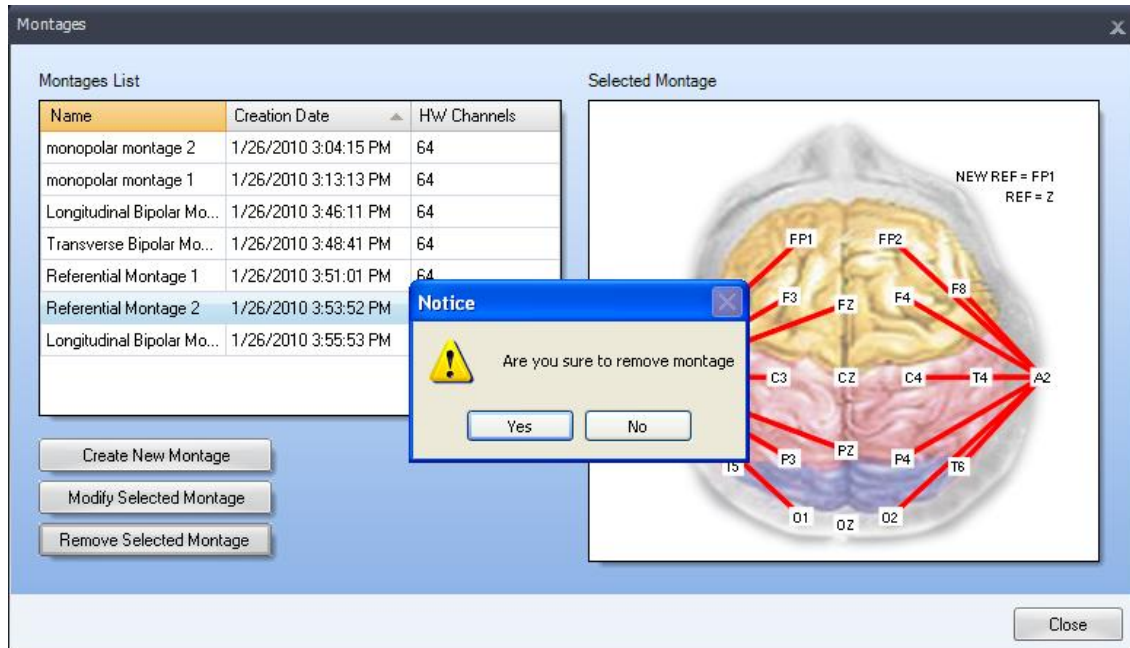

○ **Scale setting**

All the recording scales defined in **Option** menu (please see scale setting in clause o) are available in the following list. Set the number of seconds shown in one page (i.e. sec per page) or set width of each second in mm. (e.g. If you choose **10 sec per page**, it means each page shows 10 sec and if you choose **30 mm per sec**, it means that each 30 mm on the screen is 1 second)

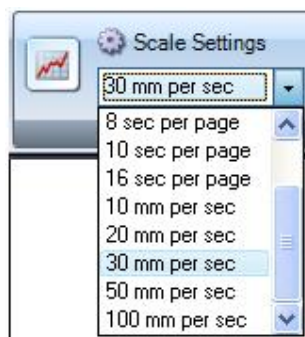

You can define any new scale you desired and not available in the list from **Option** menu (please see scale setting in clause o). After definition of the new scale it will appear on the scale list.

o Filters

All cut off frequencies (Low cut and High cut) you defined in **Option** menu are available in their relevant lists. Choose the desired values from them.

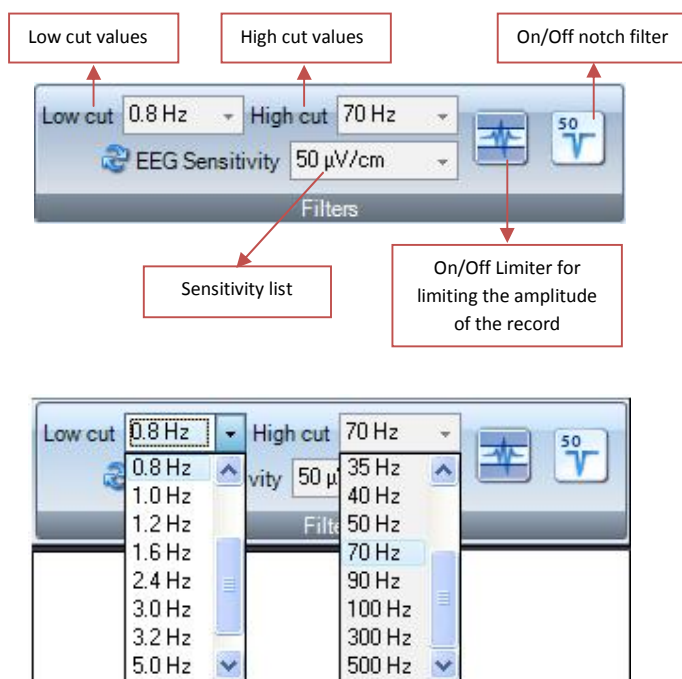

It is possible for user to choose EEG Sensitivity from the following list. Please pay attention that EEG sensitivity represents the scale of amplitude and choosing the wrong value for EEG Sensitivity do not affect the recorded signal, it may only affect the way you can view the record.

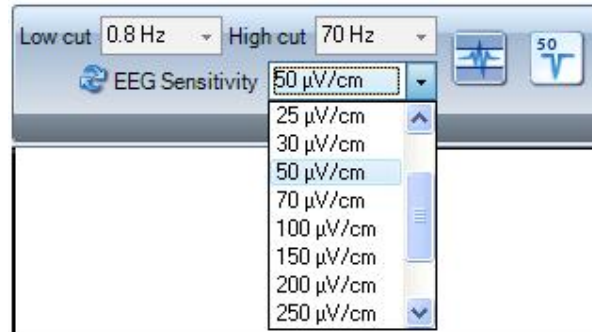

You can choose lower sensitivity values for those low amplitude patients (e.g. Brain death) and higher values for those patients with high amplitude.

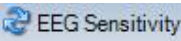
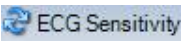
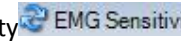

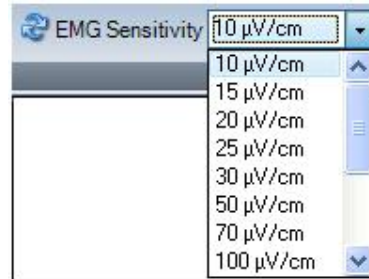
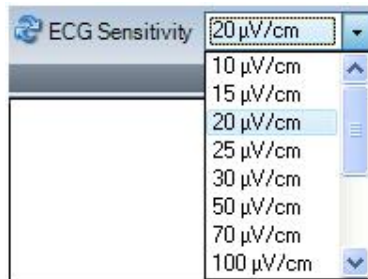
Click on  button to start setting ECG sensitivity  and EMG sensitivity .



▪ Notch Filter

You can make the notch filter 50Hz  On/Off by click on its icon. If you choose to have 60Hz notch filter, you should set it from factory setting in **Option** menu. In this case notch filter icon would be .

Bode plot of this notch filter (50 Hz) is in the following:

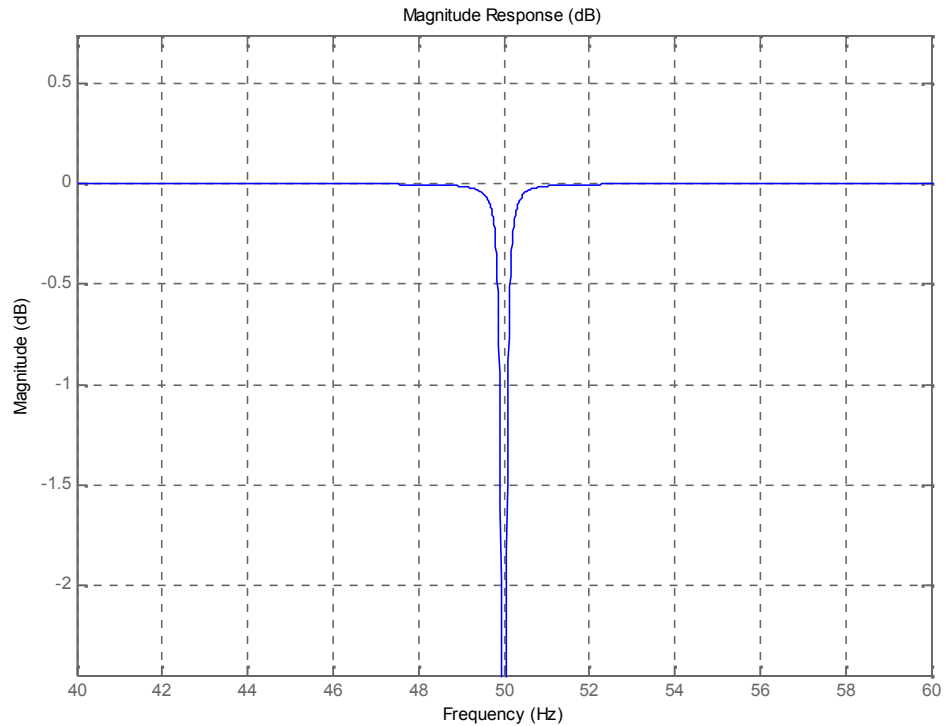

▪ Limiter

Limiter cut the recorded signals which are out of the defined band; otherwise, the signals with higher amplitude will be shown on other lines, this may cause some interference on viewing the signal.

You can turn on/off the limiter by click on its icon .

○ Photic

You can control Photic stimulator settings here. By click on either white/red LED make them on or off.

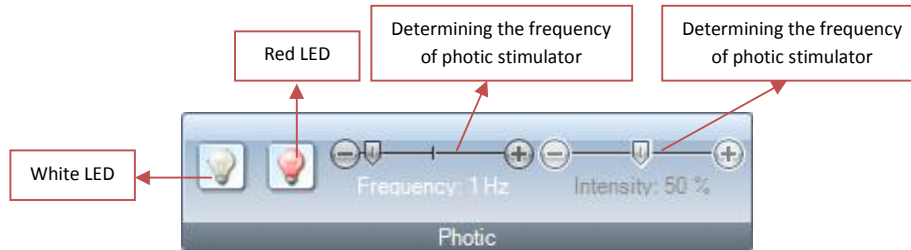

During recording when you click on each white or red photic icon, a mark will appear on top of the record screen which contains following information:

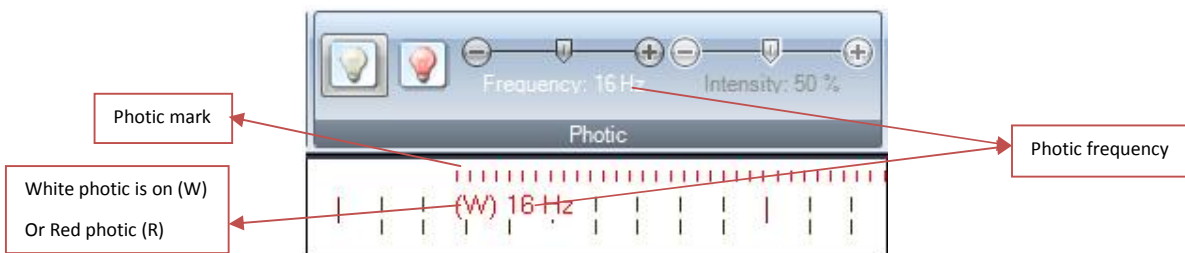

You can adjust the frequency of photic stimulator from 1 to 30 Hz and intensity from 1 to 100%. Intensity of photic stimulator is the ratio of the time that photic is on to the time that it is off in one duty cycle. Intensity is expressed in percent.

By dragging the pointer of frequency and intensity bar or click on +/- buttons you can change these parameters as you wish.

For adjusting the settings of photic mark go to **Option** menu. Further information is available in clause [ϕ](#)

○ HV

To take HV test, the patient is asked to take a deep breath. At this time click on HV icon to start HV test:

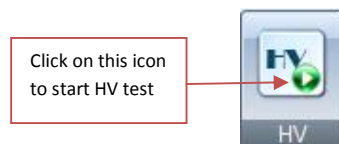

If you click on HV button another time, Post HV will start. During this time the patient is not taking deep breath. To finish the test click on this button another time.

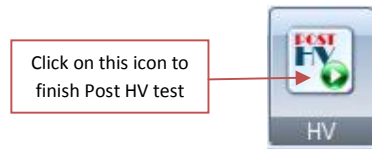

During the HV and Post HV tests their relevant mark will appear on the bottom of the page. The time duration of HV and post HV tests are also appear. As it is clear on the following page the color of HV and Post HV tests are different.

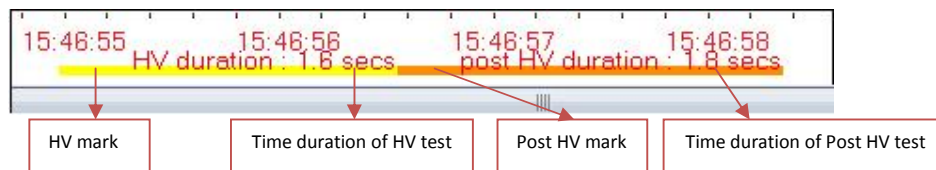

You can adjust the settings of HV marks from **Option** menu. Further information is available in clause ϕ

• Reviewing

Recording and reviewing the signals can be done simultaneously. The width of both recording and reviewing panels in the main screen of NrSign software can be changed by dragging the splitter bar into right or left direction. By choosing **Review** tab you can access to review settings.

If you want to see only the review panel, it is enough to double click on the splitter bar. The record panel will be disappeared and you'll see only the review panel. For backing your action just double click again on the splitter bar, the screen will be divided in 2 parts again and both record and review panels will be shown.





Note: Pay attention that reviewing and recording are completely **independent** and stopping replay does not affect recording action.

You can review all previously recorded signals at any time. It just needs you to load the desired record from **Load Record** in **EEG** menu (Please see clause ϕ) and then start reviewing it as explained in the following sub clauses.

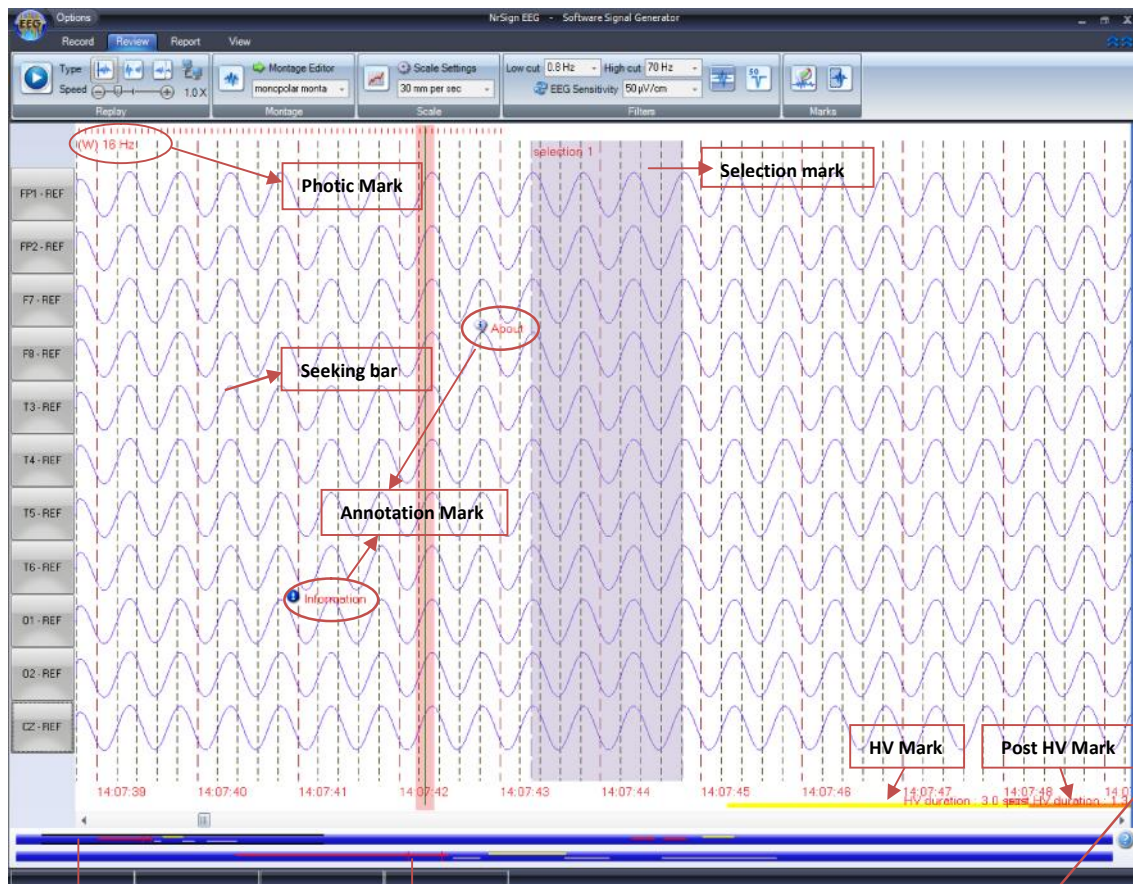

This navigation bar shows all recording period

This navigation bar shows a special part of the whole signal you select on above bar (black line)

Double click on this splitter bar to see both record and review panels or see only review panel

On review panel, there is a seeking bar. You can drag it to right or left to reach the special place on the signal you want. Two navigation bars on the bottom of the page used for navigating the recorded signal and video. In these navigation bars all marks (Photic, HV, annotation or selection) are shown by special color which has been selected previously in **Option** menu (Please see clause ϕ) The upper navigation bar shows whole recording period. To see a special period on the recorded

signal in larger scale, click on any point you want. A black line will appear on top of the selection part. This part of the signal will be showed on the lower bar. The maximum length of the signal on the lower bar is 1 hour.

Following picture is an *example* navigation bar of a recorded signal. The whole recording time is shown is blue. The photic mark is showed by red line, HV mark is showed by yellow line. Annotation mark is showed by red vertical line and selection mark is showed by green line.

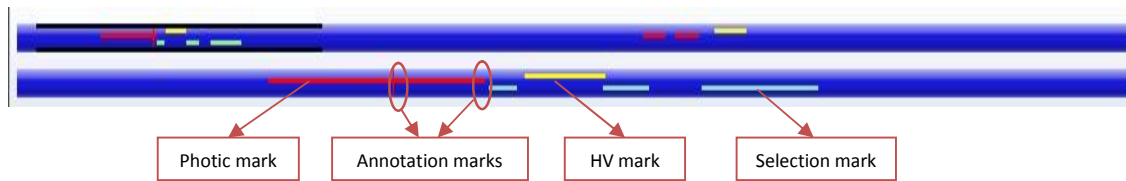

○ Review Mode

Replay any available record from this part. Start replaying the signal by clicking on **Start/Stop** button. You can adjust the speed of recording from 0.5 to 10 times faster than normal by dragging the cursor or click on +/- button. The chosen value is shown in front of speed line.



Note: Please pay attention that you can **only** increase the speed of replaying for 64ch up to 3X. But, for EEG 32ch it is possible to increase the speed of replaying up to 10X.

Note: please do not load the other patient signal for reviewing purpose when you are recording the signal for another patient.

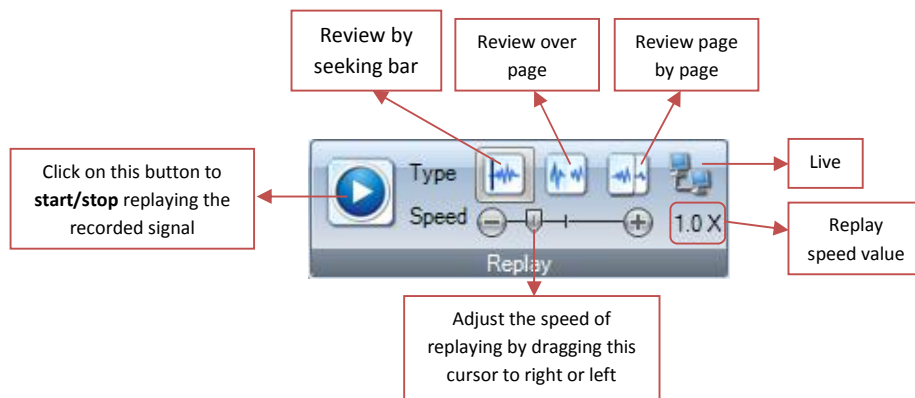

You have 4 different options for repviewing:

- **Seeking bar:**
- **Over page:**
- **Page by page:**

○ Montage Editor

Despite the type of montage you'd chosen during recording, you can choose a new montage for your reviewing. For this purpose, you can choose the desired montage from montage list, start creating a new one from Montage Editor, or modifying an existing montage from Montage Editor (Please see clause o).



This action would be helpful if you do not intend to repeat recording with different montage.

○ Scale settings

You can change the scale of the recorded signal during replaying mode. This can help you in reviewing the recorded signal with the scale you desire. All the recording scales defined in **Option** menu (please see scale setting in clause o) are available in scale setting list.

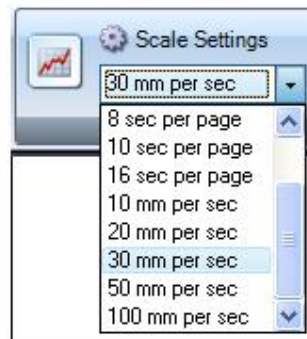

You can define any new scale from **Option** menu (please see scale setting in clause o). After definition of the new scale it will appear on the scale list.

○ Filters

All cut off frequencies (Low cut and High cut) you defined in **Option** menu are available in their relevant lists. Regardless of the values you have chosen for recording the signals, you can choose the desired values from them.

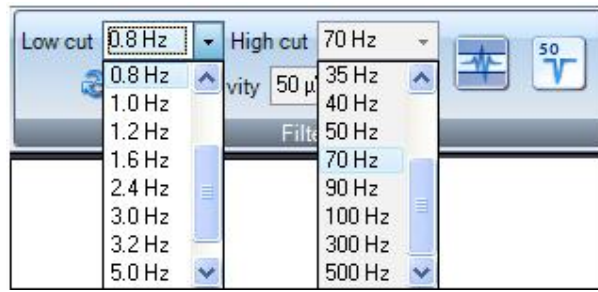
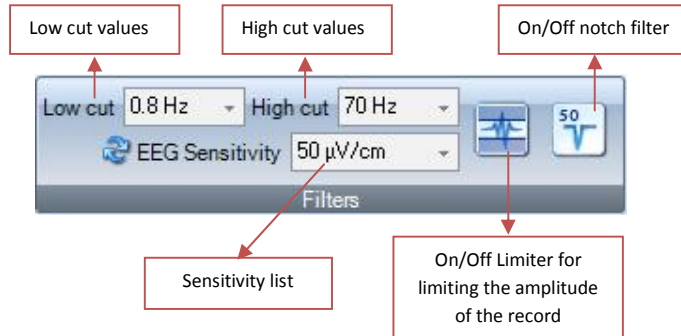



It is also possible for user to choose different EEG Sensitivity from the list.

Please pay attention that EEG sensitivity represents the scale of amplitude and choosing the wrong value for EEG Sensitivity do not affect the recorded signal, it may only affect the way you can view the record.

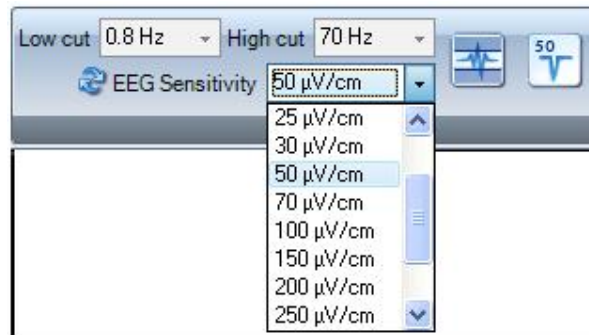
You can choose lower sensitivity values for those low amplitude patients (e.g. Brain death) and higher values for those patients with high amplitude.



Click on  EEG Sensitivity button to start setting ECG sensitivity  and EMG sensitivity .

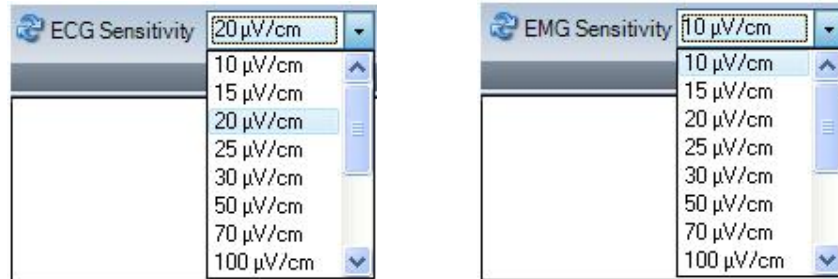

○ Marks

During your review, you can add marks to the recorded signal. Even by adding annotation or by selecting the signal. In both situations you can add notes to each mark. Mark settings (Font & Color of each mark) can be adjusted from **Option** in **EEG** menu.



You can add annotations or select special part of the signal. Any of these actions is regarded as an event and these can be seen on the two bars on bottom of the page.

▪ Annotation mark

NrSign offers this opportunity for users to add an annotation mark to special point on the recorded signal. For this purpose:

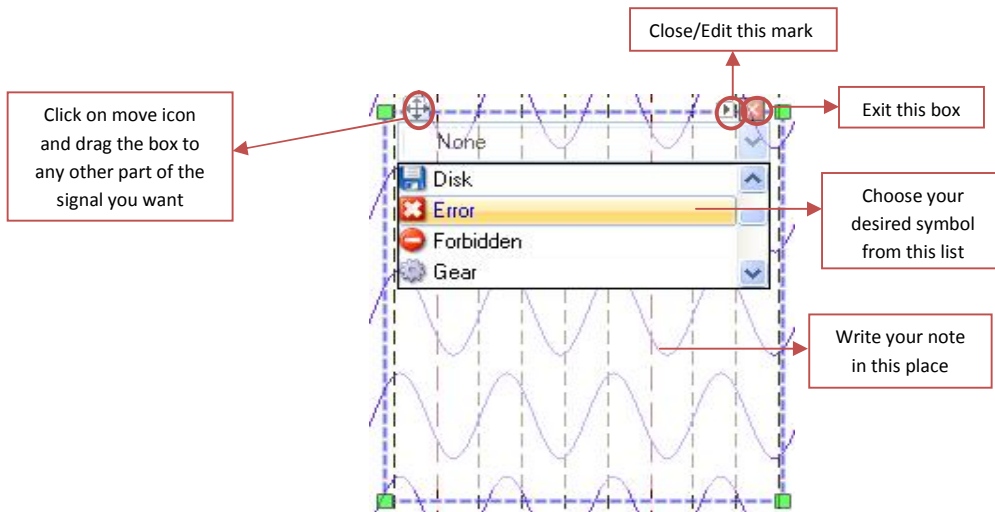

- Stop replaying the signal.
- Select Annotation Mark icon.
- Click on the specific part of the signal, the following box will be opened.

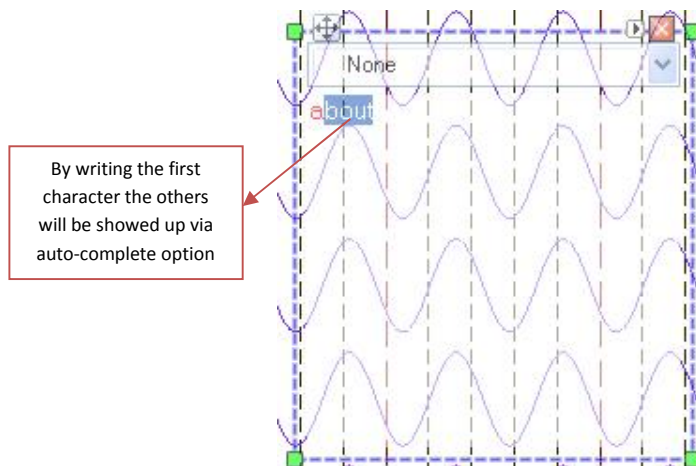

- Choose a symbol from the list (above picture) or write symbol's name on the text box below the list (following picture). By writing the first few character of any predefined name, the name will show up by auto-complete option. If the showed up name is the one you desire, press **Enter** on the keyboard to choose it as a name for your annotation. The symbols are pre-defined in **Option** menu (Please see clause ϕ



- Write any note rather than the symbol and its relevant name that you want to be shown on the annotated point of the signal.

You can close the box by click on  or by click on  button and select Close from the following box. You can also delete this annotation mark by selecting Delete in the following box.

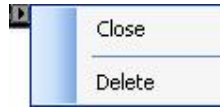



▪ Selection mark

NrSign offers this opportunity for users to select special part on the recorded signal and video and add notes and comments to this part. For this purpose:

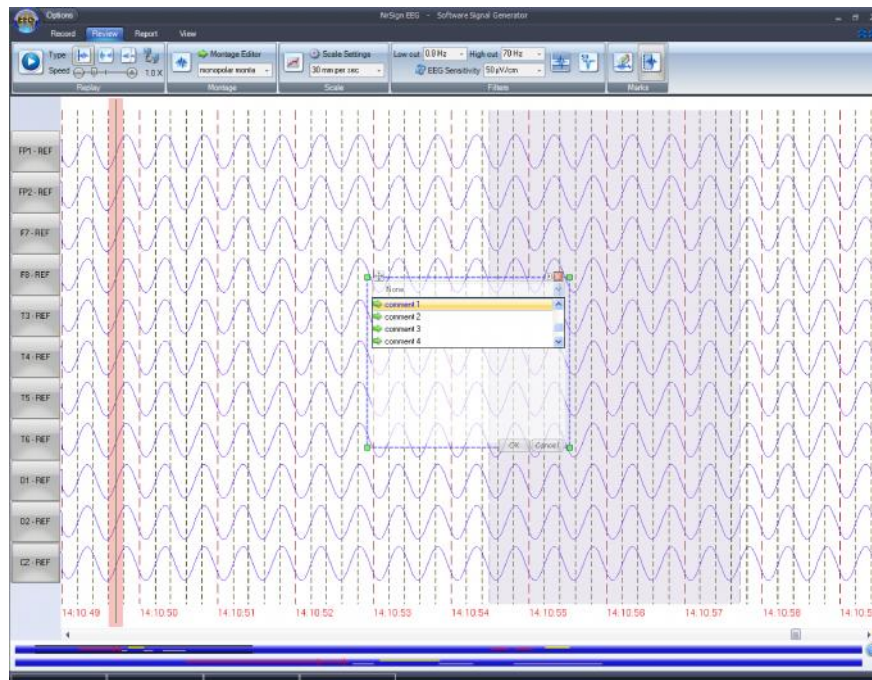
- Stop replaying the signal.
- Select the Selection Mark icon.
- Click on the specific part of the signal, a colored dashed line will be appeared on the place you selected. Hold the left click mouse and drag the dashed line to right or left to select the desired part. Release the left mouse button at the end point of the selection part.
- A box will be opened. You can choose a pre-defined title from the list which you'd defined in **Option** menu (Please see clause 4. You can add any further information you want on the text box.



You can close the box by click on  or by click on  button and select **Close** from the following box. You can also delete this annotation mark by selecting **Delete** in the following box.

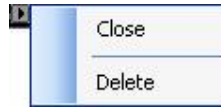

5.5.3 Ruler



- **Report**

Report tab contain two groups: Patients and Marks.

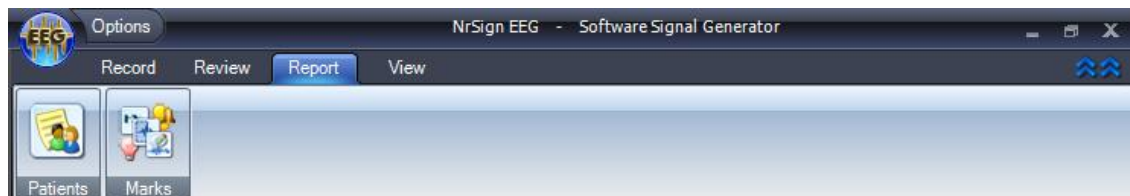

- **Patients information**

Patients group contains all patients' information; in the other word, the database is accessible from here. By click on **Patients** icon the following window will be opened.

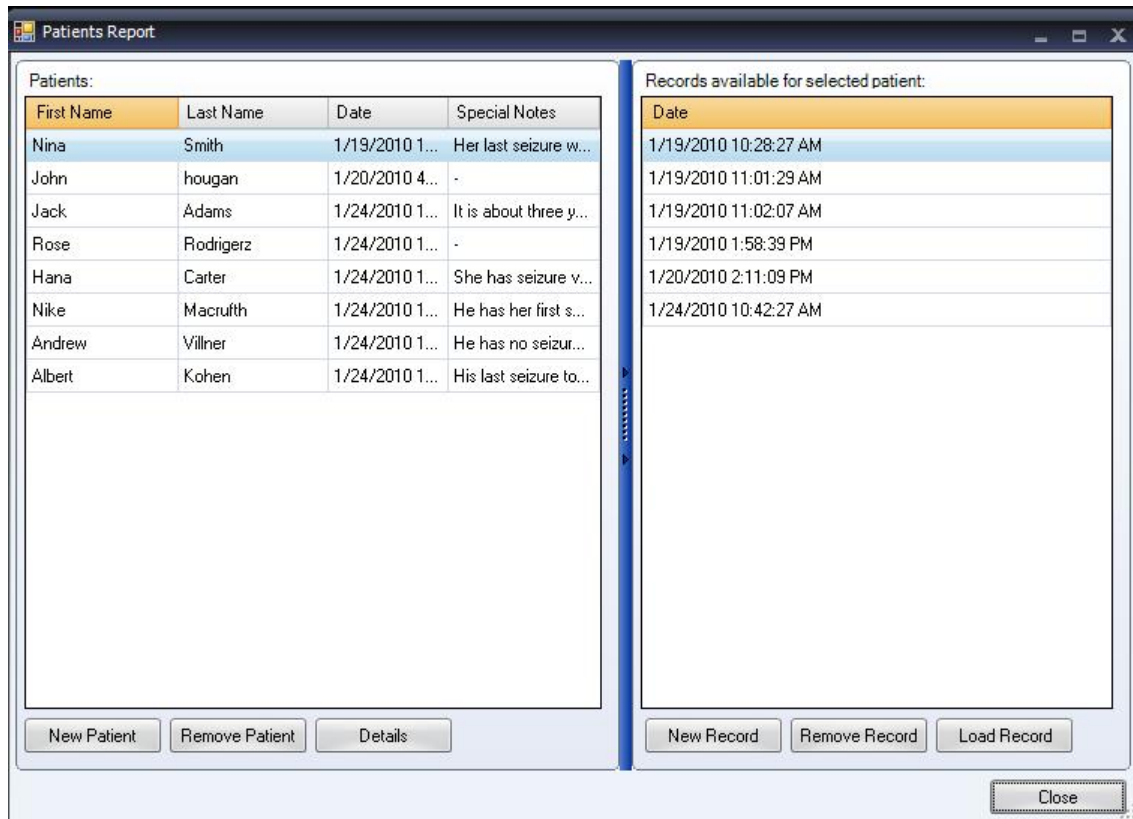

This window contains two boxes separated by a splitter bar, the left one show patients' information: first name, last name, date of record and any special note you'd defined in **New Patient** (Please see clause 10. By double click on the splitter bar you can see only patients' information. The right one shows all

From this Patients Report window, you can:

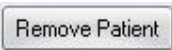
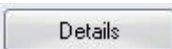
- Define a new patient by click on **New Patient** button . The further steps are the same as **EEG menu > New Patient** which has been explained in clause 10
- Remove Patient from the list by select the patient and then click on Remove Patient button .
- See/ edit the initial information you defined for each patient by click on **Details** button . By click on this button the following window will be opened, in which you can make any changes you desire and then click on Save as button to save the changes you'd made.

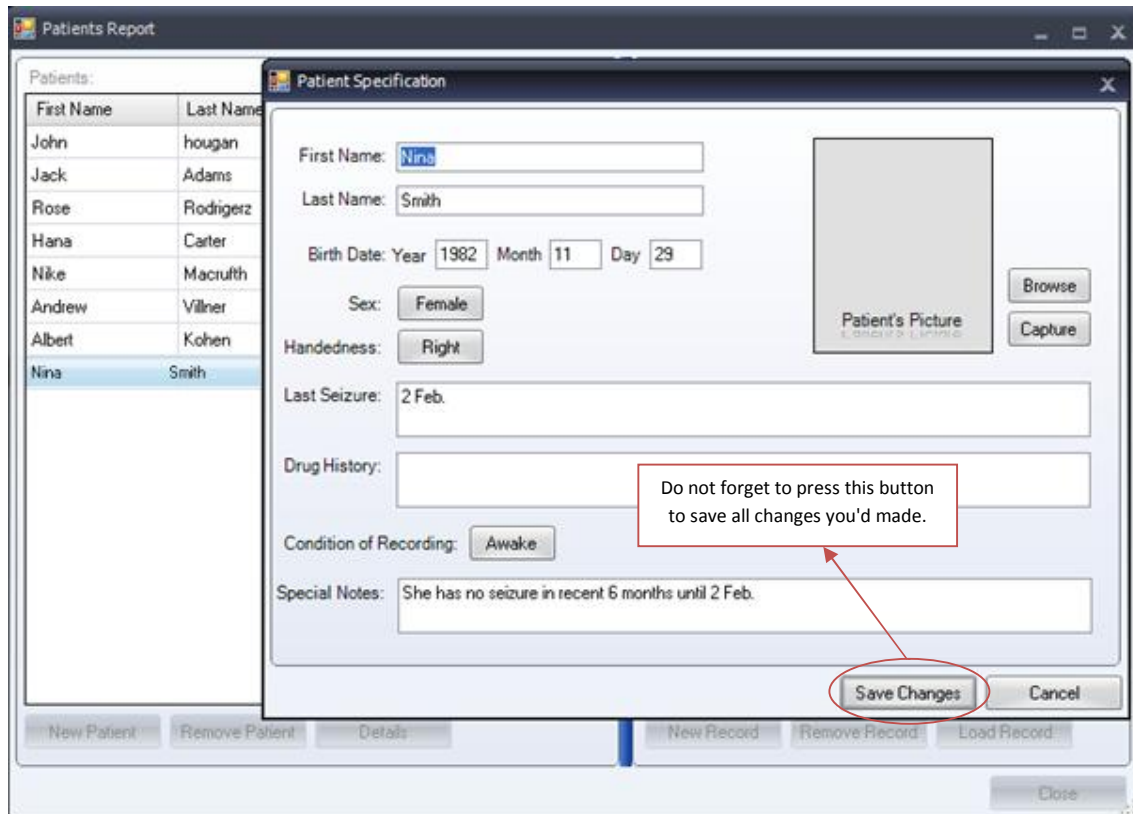

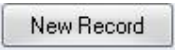
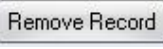
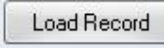
- Start a new record for a special patient selected from the left box list by click on **New Record** button .
- Remove any selected record of a special patient by selecting the record from the right box list and then click on **Remove Record** button .
- Load any selected record in the right box by click on **Load Record** button .

○ Marks

NrSign software adds some marks on the recorded signal: Photic Mark, HV mark, Start/Stop mark and Patient Push Button. You can also add annotation mark or selection on the recorded signal. These marks settings (font, color...) are all set in **Option** menu (Please see clause 4. For preparing a report of marks, click on **Marks** in **Report** tab, **Mark View Form** window will be opened in which list of all marks is available.

Click on any of these buttons to select them to be shown in the table.

Selection of these marks will change their color. E.g. here, Push Button is not selected.

Selected types will be listed in the table.

Annotation Selection PushButton HV Photic StartStop

Type	Title	Date Time	Duration	Extra Info	Extraction Mode
StartStop	-	2/9/2010 2:07:14 ...	-	-	Signal & Video <input checked="" type="checkbox"/>
StartStop	-	2/9/2010 2:07:14 ...	-	-	Signal Only <input checked="" type="checkbox"/>
Photic	-	2/9/2010 2:07:32 ...	-	-	Signal & Video <input type="checkbox"/>
HV	-	2/9/2010 2:07:47 ...	3.0 Secs	-	Signal & Video <input checked="" type="checkbox"/>
Annotation	About	2/9/2010 2:08:25 ...	-	-	Signal & Video <input type="checkbox"/>
Annotation	Information	2/9/2010 2:14:46 ...	-	-	Signal & Video <input type="checkbox"/>
Selection	-	2/9/2010 2:08:39 ...	-	-	Video Only <input checked="" type="checkbox"/>
Photic	-	2/9/2010 2:09:32 ...	-	-	Signal & Video <input type="checkbox"/>
Photic	-	2/9/2010 2:09:39 ...	-	-	Signal & Video <input type="checkbox"/>
HV	-	2/9/2010 2:09:48 ...	5.2 Secs	-	Signal & Video <input type="checkbox"/>
Selection	-	2/9/2010 2:10:03 ...	-	-	Signal & Video <input type="checkbox"/>
Selection	-	2/9/2010 2:10:30 ...	-	-	Signal & Video <input type="checkbox"/>
Selection	-	2/9/2010 2:11:04 ...	-	-	Signal & Video <input type="checkbox"/>

Click on this button will navigate you to the selected mark on the table

Click on this button to save the selected marks on new destination

Navigate Through Highlighted Mark (double-click) Remove Selected Marks Close

On top of the **Mark View Form** window, there are six buttons relevant to each probable mark in NrSign software. By click on each of these buttons you can select the mark you want to have its information be shown in the table. The relevant information about each selected mark is appeared on the table. The table contains the following information:

- **Type:** Shows the type of the mark (Start/Stop, Photic, HV...)
- **Title:** Shows the title of annotation and selection marks (if available)
- **Date time:** Shows the time and date of the mark
- **Duration:** Shows duration of the mark
- **Extra info:** Shows any further information (if available)
- **Extraction mode:** Shows the report contains the marks of Signal Only / Video Only or both Signal & Video. Click on this cell to change extraction mode from **Signal & Video** to **Signal Only** or **Video Only**.

Click on the check box in front of each row in the table to have them in your report. You can select/deselect or even reverse your selected marks by click on the relevant buttons on the right side of the table. The report of the selected marks will be summarized in a *.doc file automatically.

You can save the report of the selected marks in new destination

Note: NR SIGN INC report option needs Microsoft Word program, so it should be installed on the computer before using the EEG software.

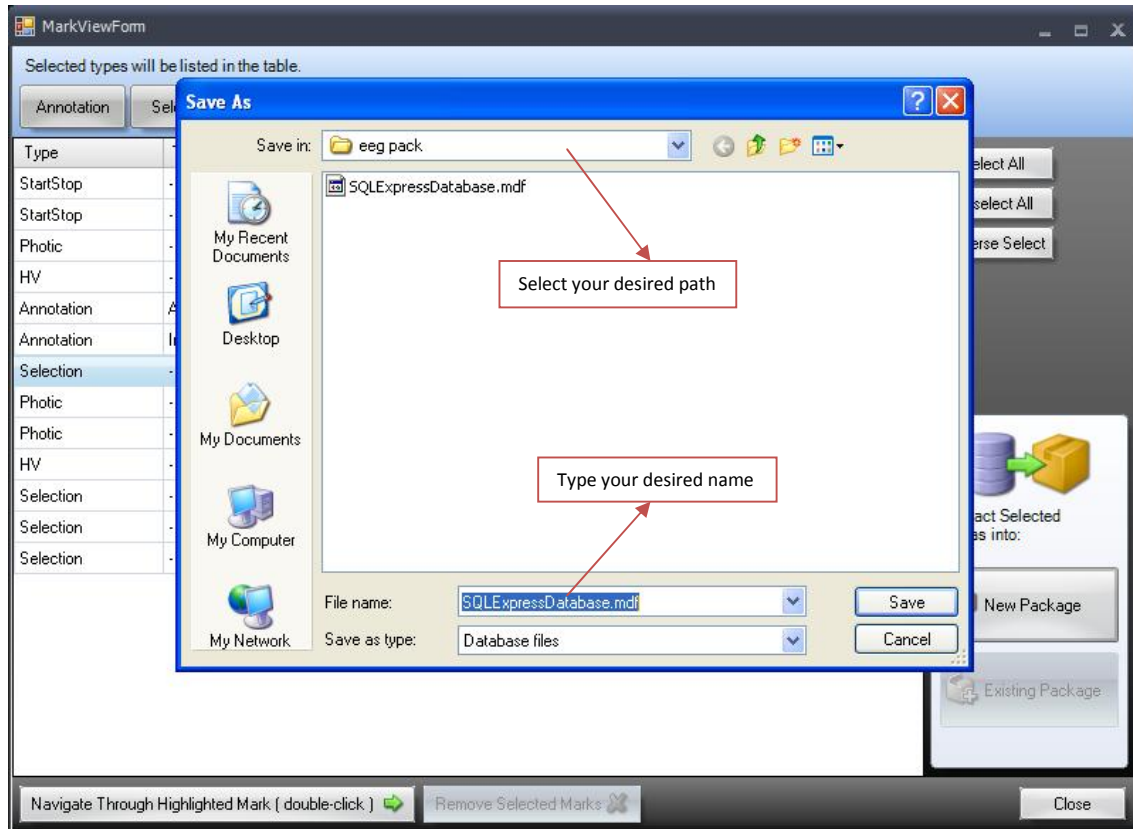

Navigation to any special mark on the Signal and Video is possible through selecting the mark from the table and then click on navigation button on the bottom of the table; or, by double clicking on the desired row of the table.

Printing the signals:

The selected patient data can be printed on these windows by clicking on the “print selected mark” tab (the desired events or mark shall be selected at first like the report generating option). Also the signals or data can be printed on the main EEG screen tab according to below pictures.

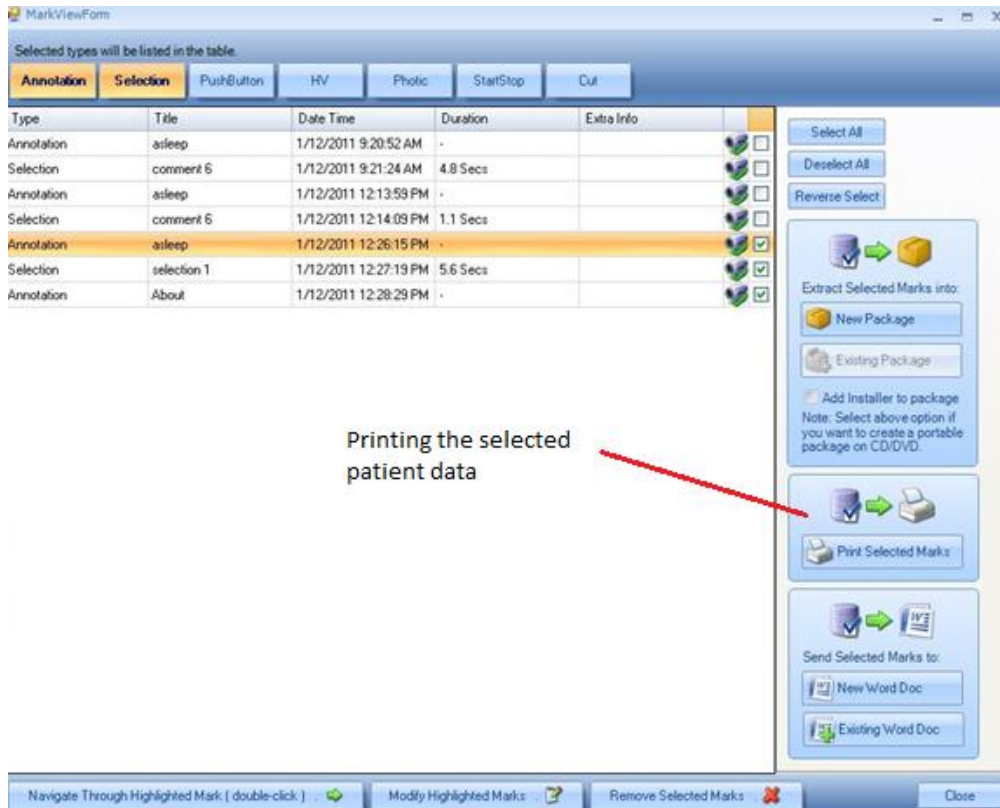

Transferring the selected patient data to the new destination:

Click on the extract info box on the front of each desired type, title (please chose with video or without the video). Please click on the new package on the" Extract selected Mark info bottom". Select the desired package destination in the PC hard drive. Please wait for the extraction to be finished according to below pictures.

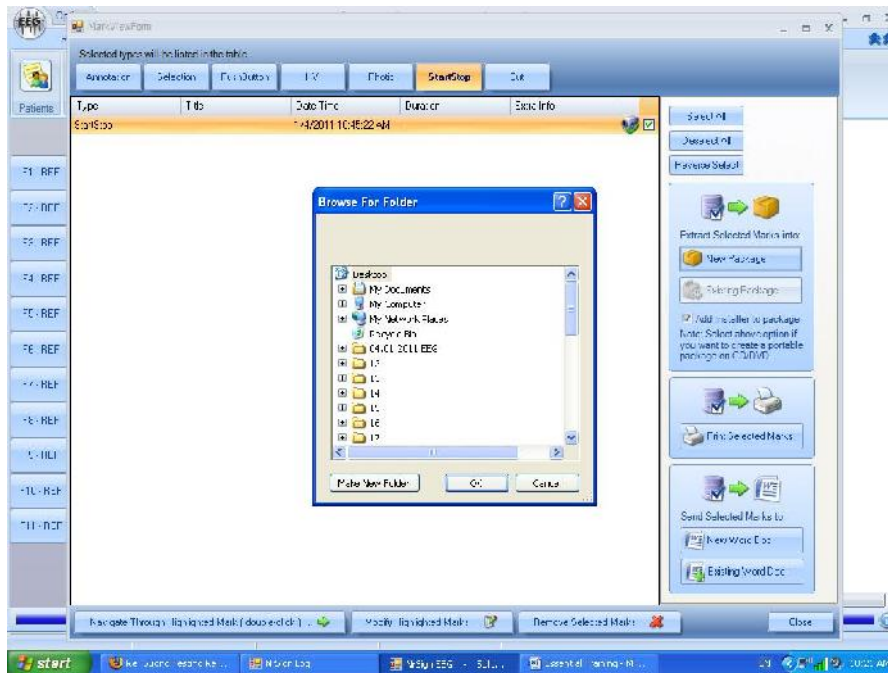
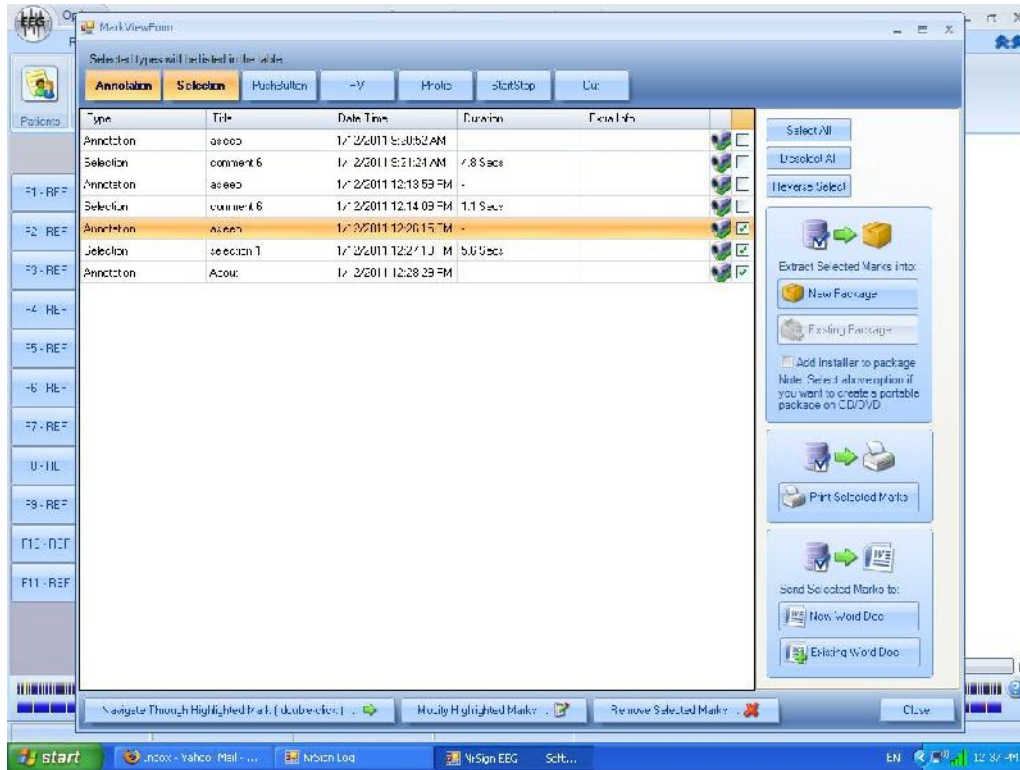

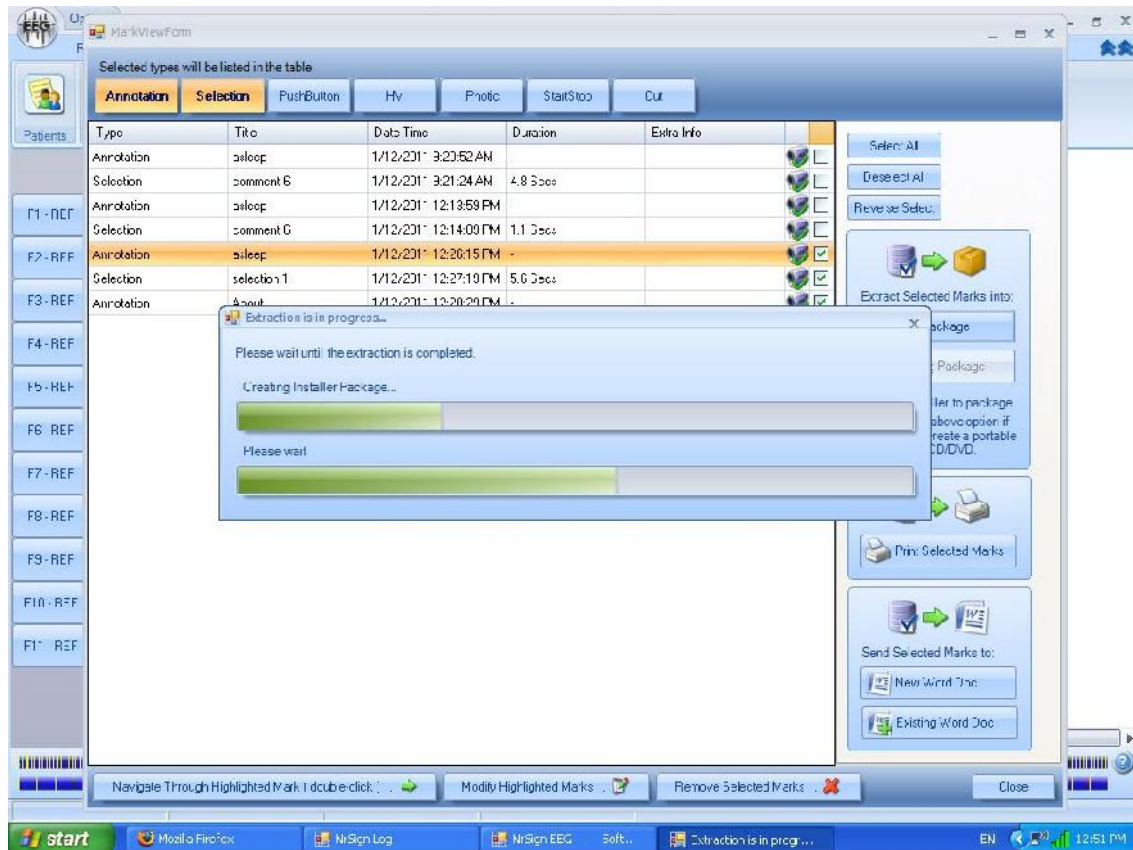

Now the new package extracted in your computer hard drive or on the external hard drive. If you want to copy it in the CD or DVD, you shall use NERO or the same program for this purpose.

Note: if you want review the patient data for any computer, the whole EEG software package provided by NR SIGN INC shall be copy on the CD or DVD and shall be installed in new computer according to: section 6.3 " NR SIGN EEG Software installation".

Note: If you are using the Windows 7 or Vista to review the signals, please run the software as an administrator.

How we can connect to the new patient data base on EEG

Click on the " EEG option" tab and close your current record by clicking on its tab, and then click on "connect to extracted package". Choose the path where you extracted the package. Then come back to EEG option and click on "load the record" tab and choose the desired patient data. The patient data will open for reviewing purpose according to below pictures.

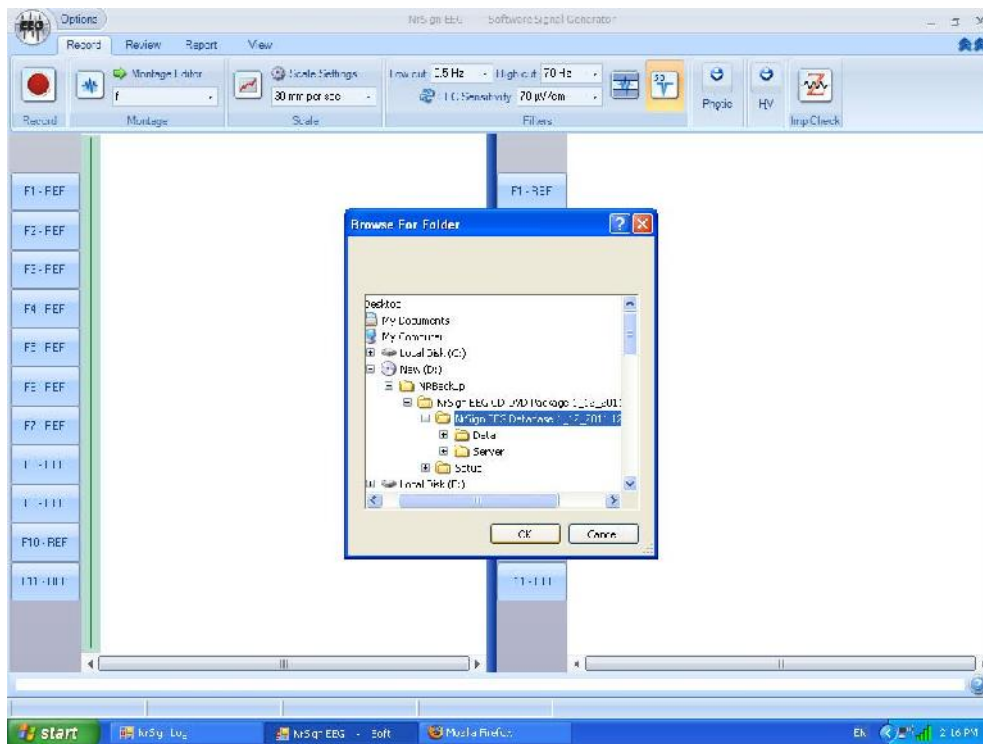
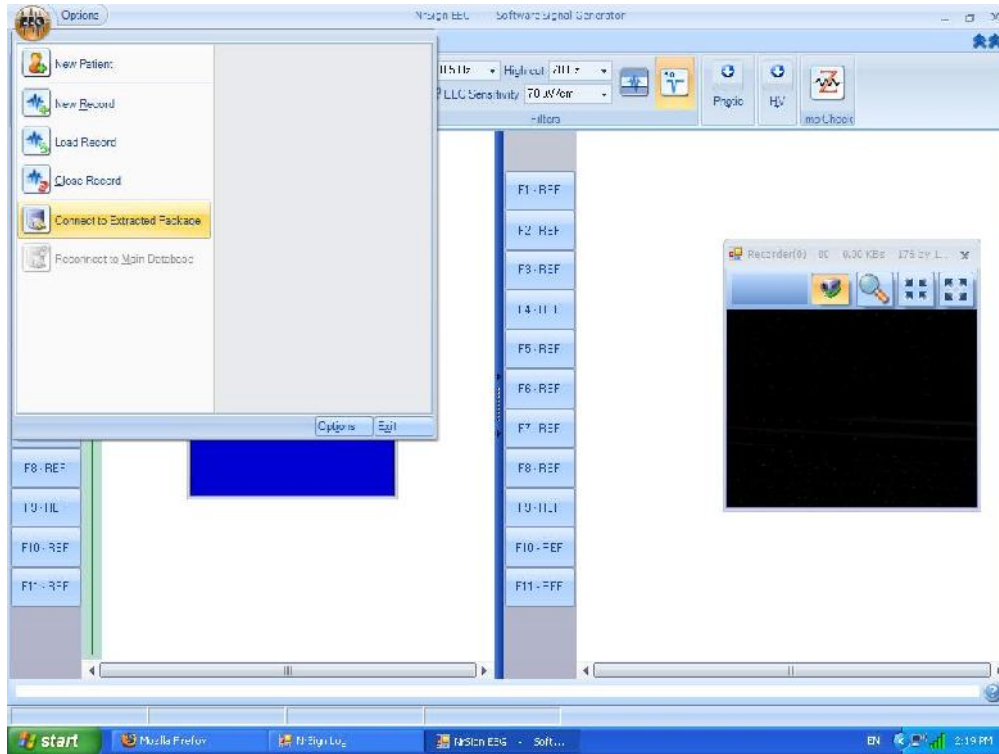

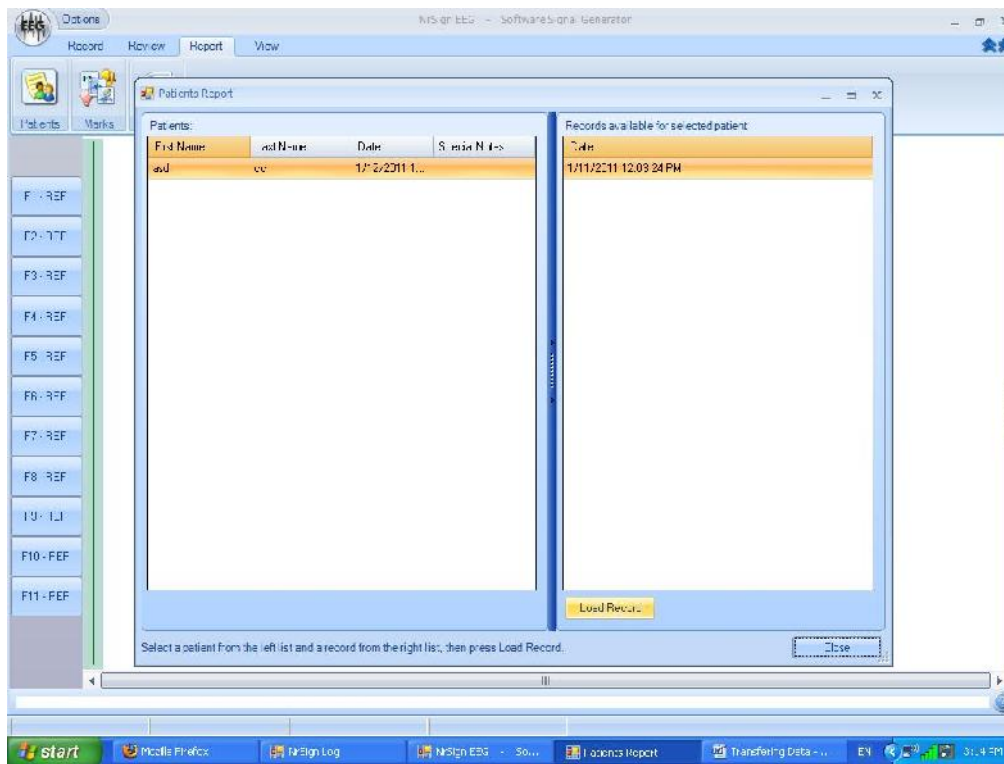
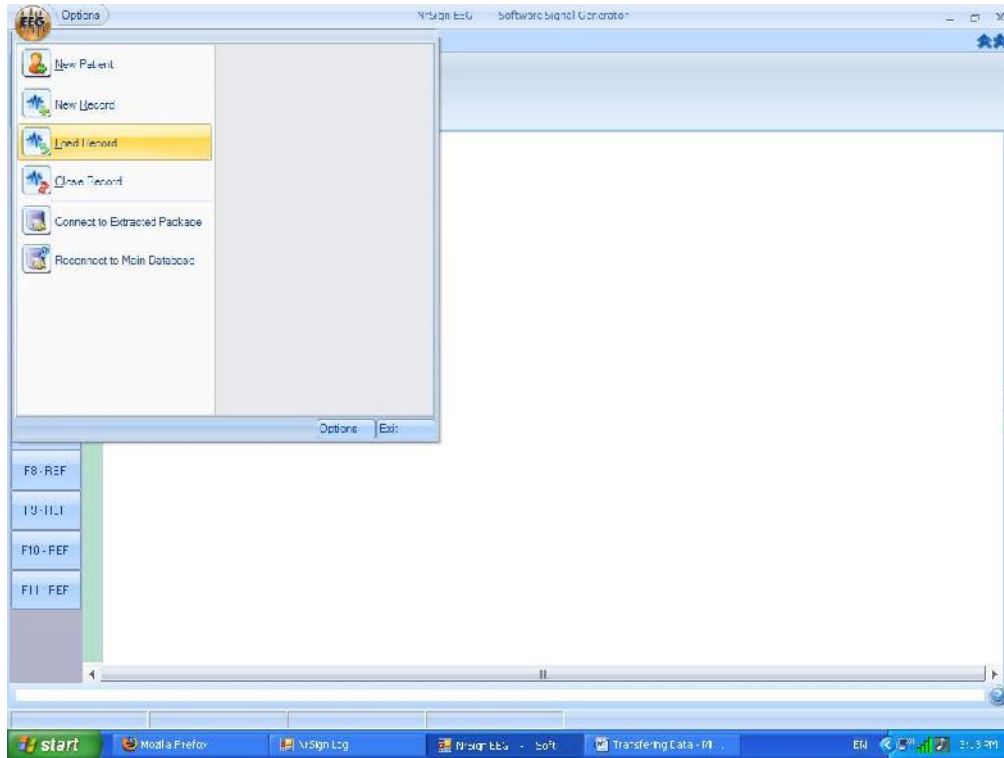

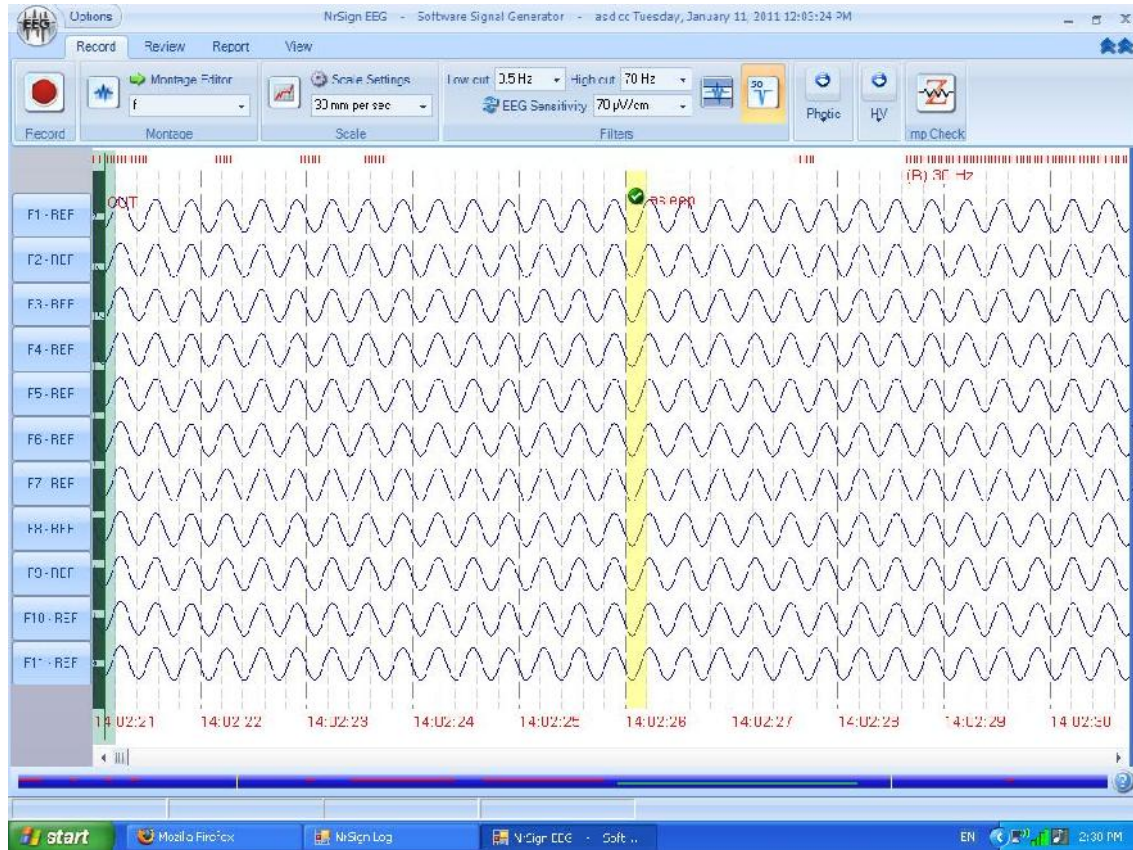

- **View**

In **View** tab you can select to view Video Recorder window and montage figure for record panel or Video Re-player window and montage figure for review panel.



Select



to view video recorder/ re-player.

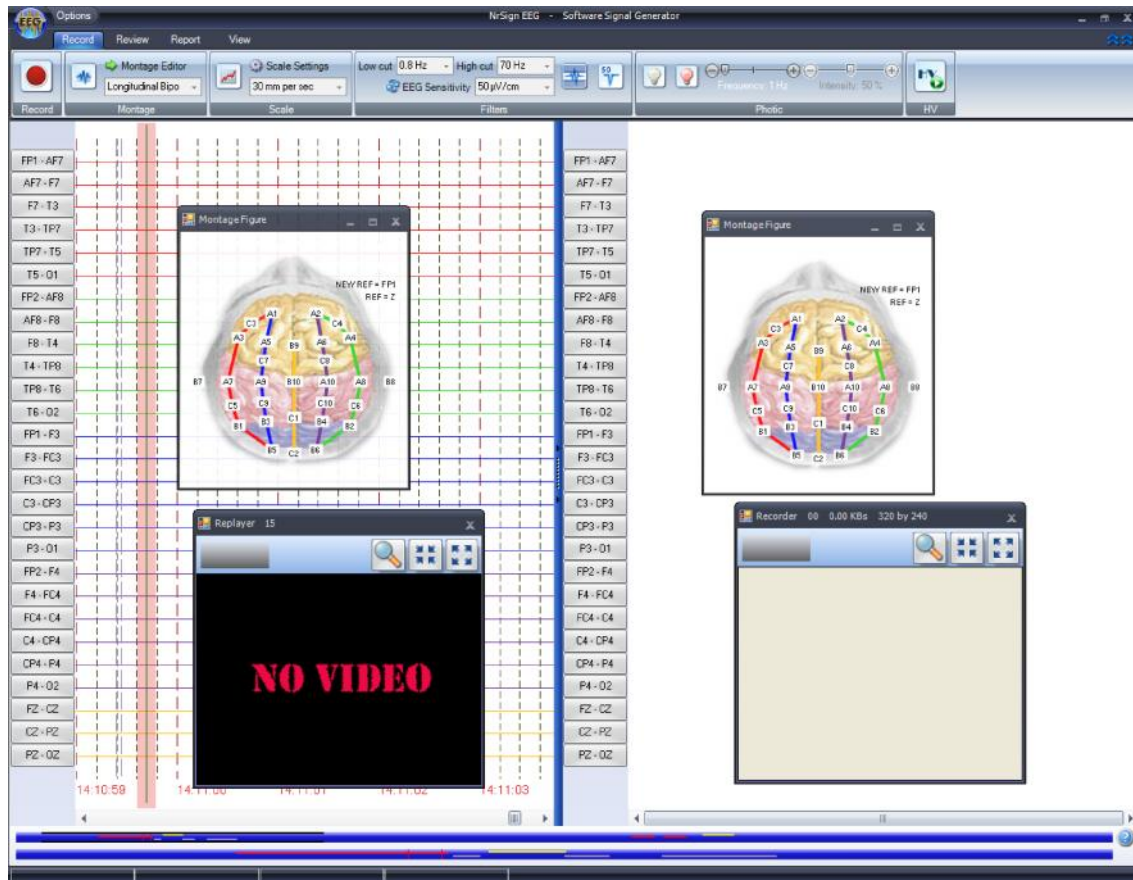

If the montage figure window is available, you can see the montage figure and the new reference you chose.

- **Quick guide for operating the NRSIGN system**

This clause is a quick guide for operating either NRSIGN 3840 or NRSIGN 5020. Here, in this clause the different steps for operating these systems which has been explained in previous clauses are summarized chronologically. For further information please refer to the clauses mentioned below:

Please do the following steps prior to system usage:

- **Assemble the equipment**

Unpack the delivered equipment. Place each part of the equipment on the appropriate place on trolley. (Please see clause for further information about the placement and assemblage)

- **Connect all cables and wires**

Connect different parts of the equipment with relevant cables and wires according to what has been explained in clause 0

- **Check all connections**

Before turning the system on, please make sure all connections are according to the instructions available in clause 0 of this user manual.

- **Turn on the system**

For turning the system on, do the following steps:

- o Turn the computer on
- o Turn the interface on,
By turning on the interface, its power indicator turns on. The two other indicators on the interface turn on when the cables are both connected and head box is turn on.
- o Turn the head box on.

After turning on the head box, the power indicators on the head box (both 32ch and 64ch) turn on. For 32ch head box if the connection between head box and interface is available, only the indicator on the interface related to 1-32ch turns on. For 64ch head box if both connections between head box and interface are available, both indicators on the interface related to 1-32ch and 33-64ch will turn on. Please check the indicators to make sure the system is turned on.

- **Run NRSIGN software**

Run NRSIGN software by double click on its icon on the desktop.

- **Initialize the software**

It is highly recommended to set your software in the first time you're using it. Please initialize the software by setting the primary settings according to clause 0. These settings are as follows:

- o Appearance settings: set your work space as you wish from this part.
- o Default settings: define new values for scale, low cut/ high cut filters or modify or remove them from here. You can also set the selection marks settings.
- o Factory settings: Set the number of channels, hard codes, notch filter frequency (50/ 60 Hz), sample rat ... Please pay attention that you're not allowed to change factory settings. Only in some special case you're allowed to access this part.

It is possible to modify these settings at any time you wish.

- **Define desired montages**

Define the required montages you want to use according to clause o. You can also define your desired montages whenever you desire. But, it is recommended to define the most frequently used montages before using the system.

- **Exit software**
Exit the software to have the above settings become the initial settings of the software.

- **Run NRSIGN software**
After initializing the software you can run the software by click on its icon on the desktop.

- **Connect all electrodes**
After running the software, connect all patients' electrodes prior to start any other action.

- **Define new patient**
After connecting all electrodes, if the patient has been defined previously escape this step; otherwise, start define a new patient according to clause .

- **Start a new record**
Start a new record for the defined patient according to clause .

- **Select sensitivity, filters and scale settings**
. You can use default values for sensitivity, filters and scale settings or select your desired values for them from their lists. Please see clause o and o for more information.

- **Photic and HV**
Make Photic or HV on before starting the test or during your test. Please see clause o and o.

- **Start recording**
After performing all above steps, you can start recording according to clause .

- **Review, annotate, select...**
During recording or even after recording you can review the records. There is no conflict between recording and reviewing action. Please refer to clause for further information about reviewing.

- **Report**

Prepare a report from the record according to clause .

- **Save or print the signal**

There is no need for saving your records, since they will save automatically. But, it is highly recommended to save every 12 h record on a DVD or external hard drive to avoid HDD overflow if you use EEG 5000Q system.

- **Cleaning and maintenance activities**

- **Cleaning**

NRSIGN 3840/ NRSIGN 5000Q are medical electrical equipment; therefore, they should be handled very carefully to avoid any mechanical shock such as falling. Since these devices have no special protection against water ingress, be careful not to put any liquid container on or near them. Before cleaning the equipment turn it off and pull out its main plug.



Warning: *In case of any liquid ingress inside the equipment, equipment fall or any other unexpected event, do not try to turn on the system. Please consult NrSign experts as soon as possible.*

The equipment can be cleaned with cotton swabs dipped in isopropyl alcohol mixed with water every day or week. Gathering dust with compressed air would be useful for computer cleaning every 6 months.

All electrodes can be cleaned similar to the equipment by means of isopropyl alcohol after each patient test. **There is no need for electrode sterilization.**

- **System maintenance activities**

There is no special maintenance activities required for NR SIGN 3840 routine EEG and NR SIGN 5020 EEG monitoring. But, user is preferably asked to perform some maintenance activities periodically for patient and user safety and also for better system performance. Some of these activities are listed below:

- Overall mechanical condition of different parts of the equipment
- Availability and legibility of identification and safety labels and marks necessary for system safe usage
- Correctness of routine system function
- Simple functional test
- Quality of system connections and cables

- Quality of system accessories
- Verifying and checking software version. **Contact NrSign for more information about Software new versions.**
- Checking the four rolls to avoid any defected or loosened rolls

▪ Windows updates

NRSIGN software works on Microsoft Windows Operating System. It is highly recommended to install critical Updates when they become available by Microsoft.



Note: Do not install any Microsoft Windows Operating System Service Pack without NrSign conformation.



Note: Do not install any other driver other than those provided by NrSign because they may affect your system performance.

▪ Repairs

Any repairs have to be carried out by NrSign or its authorized representative service personnel. Please consider the following warnings:



Warning: If there is any problem, an error message will be appeared. Please turn off the system one time, if the error is not disappeared please notice NrSign or its authorized representative.



Warning: Do not send back your equipment without any consultation with NrSign Manufacturing or its authorized representative.



Warning: Do not try to fix or repair the equipment independently or by any other person except NrSign service personnel or its authorized representative; otherwise, NrSign won't be responsible for any resulted consequences. Also, if the system is still under guarantee NrSign won't be responsible for providing relevant guarantee items any more.

Contact information is available in clause 1.6.3 of this user manual.

• Trouble shooting

Here, in this clause some simple trouble shootings are listed. Through following this information, you can solve some routine problems a user may encounter during system usage.

Problem	Solution
During recording, all channels show straight lines.	<p>1) Check all indicators on head box and interface are on. If any of them is off check the followings:</p> <ul style="list-style-type: none">- Make sure all power switches are on.- All connectors and cables are connected. <p>2) Check electrode CG and its wire and replace them if necessary.</p> <p>3) Check Z electrode and its wire and replace them if necessary.</p> <p>4) If the problem is still existed please contact NrSign Manufacturing Co.</p>
During recording less than 10 lines show straight lines.	<p>1) Release the wire from the electrode which shows straight line. Hit the end of the wire and look at monitor at the same time:</p> <ul style="list-style-type: none">- If you see any artifact make sure the problem is not because of head box and wire, so check the electrode accordingly:<ul style="list-style-type: none">• Electrode is exactly placed on skin of head.• If the problem is still existed the electrode shall be replaced.- If there is no artifact:<ul style="list-style-type: none">• Replace the wire.• If the problem is still existed, please contact NrSign.
During recording, some lines has artifact	<p>1) check system Earth (Earthing system connection)</p> <p>2) Stop recording. Choose Hardware testing from EEG menu, here all lines are Mono</p>

Polar. Detect those lines with artifact and connect them to CG bracelet. All lines become straight. Connect these wires one by one to the place of a correct electrode which has normal signal. If the problem is solved, you'll be sure that wires have no problem. So move the electrode which has artifact to place correctly on skin of head. If the problem is still existed, replace the electrode.

During recording all channels have artifact

- 1) Check Earthing system
- 2) If the problem is still existed, contact NrSign Manufacturing Co. or its representative.

Your software will not run properly

- 1) make sure you install direct x
- 2) make sure you install framework.net 3.5
- 3) check your software config
 - a. please go to windows program file/ NRSIGN INC/ NR SIGN EEG/CONFIG
 - b. the inside of your recording software CONFIG should be

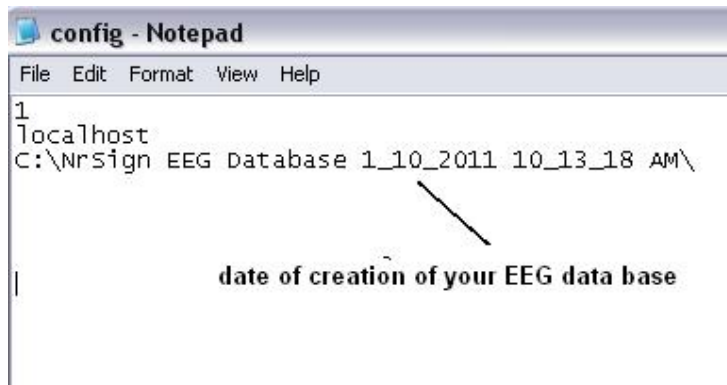

If there is something else please delete the file, and run the EEG NRSIGN icon in your computer desktop, and check this config again. It should be corrected.

• **Technical data**

The following table summarizes the main feature and characteristics of the NRSIGN:

General description:

NR SIGN 5000 Q EEG monitoring

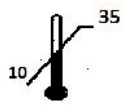
Degree of accuracy	Frequency: 1 m Sec. and Amplitude: 1 μ V
Power	
Power supply	110-220 V ~ , 50 or 60 Hz, 4Amax via isolated power supply
Power consumption	500 VAmx
Power supply isolation	2500 V from power line
Dimensions	
Weight	
Environment conditions	
Temperature	10°-35° C 
Humidity	25-85%RH.
Pressure	Atmosphere pressure
Amplifier	
Number of channels	32 ch – 128 ch
Sensitivity	10UV – 1mV
Input impedance	> 1000 M Ω
Common mode rejection ratio (CMRR)	> 100 dB
Low pass filter (-3 dB)	< 0.1 Hz
High pass filter (-3 dB)	> 1 kHz
Noise	< 0.1 μ V
Notch Filter	50 Hz and 60 Hz
Interface (A/D)	
Sample Rate	> 800 sample/second
Programmable	
Channel recording capability	32 ch – 128 ch
Noise level	< 0.1uV
Photic Stimulator	
Specification	14 row and 3 column LED Bright white Low current, consumption Flashing mode Frequency 0-50 HZ
Video Recording device	

Camera type	Optional
System of signal	PAL/NTSC
Number of pixel	PAL: 500(H)×582(V) NTSC: 510(H)×492(V)
Resolution	420 TV lines (Horizontal)
Operation voltage	DC 12 V, ≤ 250mA
Capture Recording format	MPEG-1, MPEG-2 and Microsoft MPEG-4
Push button Event	
Specification	Finger touch switch for patient event Reliable and strength switch Mentioned as both isolated and non isolated input for interfacing board
Software	
Operating system	Windows XP, Vista, Seven (32 bits)
Application software	NR SIGN software
Computer	
PC	At least CPU: Intel Core 2 Quad- Q8200@ 2.33 GHz, RAM: 4G, HDD: 1 TB, GPU: Geforce 9600 GT-1024 MB.
Monitor	LCD (17")
Keyboard	PC-AT compatible ASCII keyboard
Mouse	USB / PS2 compatible mouse
Patient management (DB)	
Specific feature	Network-compatible SQL/ MS SQL patient data base
EMG recording tool	2 ch surface EMG
ECG recording tool	1 ch EEG

NR SIGN 3840 EEG

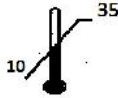
Degree of accuracy	Frequency: 1 m Sec. and Amplitude: 1μV
Power	
Power supply	90-240 V ~ , 50 or 60 Hz, 4Amax via isolated power supply
Power consumption	500 maxVA
Power supply isolation	500 V from power line
Dimensions	
Weight	
Environment conditions	
Temperature	10° -37° C 
Humidity	25% to 85 %
Pressure	Atmosphere pressure

Amplifier

Number of channels	19 ch – 32 ch
Sensitivity	10uv/cm–3mV/cm
Input impedance	> 1000 MΩ
Common mode rejection ratio (CMRR)	> 110 dB
Low pass filter (-3 dB)	< 0.1 Hz
High pass filter (-3 dB)	> 1 kHz
Noise	< 0.1 μV
Notch Filter	50 Hz and 60 Hz (optional)

Interface (A/D)

Sample Rate Programmable	500 – 2k sample/second (programmable)
Channel recording capability	19-128 ch
Noise level	< 0.1uV
A/D convertor	16bits

Photic Stimulator

Specification	14 row and 3 column LED Bright white Low current, consumption Flashing mode Frequency 0-50 HZ
---------------	---

Software

Operating system	Windows XP, Vista, Seven, Eight
Application software	NR SIGN software
EEG data analysis option	Brain mapping, spike detection, spike and slow detection
Impedance checking	Programmable threshold (1k-100kohm)

Computer

PC	At least CPU= Intel Core 2 Quad @ 3 GHz RAM = 1GB DDR2, HDD= 1 TB, GPU= NVIDIA Geforce 7300 SE, Mother board= GIGABYTE, 945PL with onboard sound card
Monitor	LCD (17")
Keyboard	PC-AT compatible ASCII keyboard
Mouse	USB / PS2 compatible mouse

Patient management (DB)

Specific feature	Network-compatible SQL/ MS SQL patient data base
------------------	--

EMG recording tool

2 ch surface EMG

ECG recording tool

1 ch EEG

DC recording channels (optional)

8 Bipolar channels (optional)

Patient PB (Mark channel)

Optional

Video Recording device

Optional

System of signal	PAL/NTSC
Number of pixel	
Resolution	420 TV lines (Horizontal)
Operation voltage	DC 12 V, \leq 250mA
Capture Recording format	MPEG-1, MPEG-2 and Microsoft MPEG-4

• License

NrSign certifies:

- ISO 13485:2003, CMDCAS
- Directive 93/42/EEC
- CE
- Health's Canada
- FDA QRS

Notified body:

- BSI CANADA

Devices of the NRSIGN series meet the requirements of the following harmonized standards:

- IEC 60601-1:2005, IEC 60601-1-2:2007, IEC 60601-1-4:2003, IEC 60601-2-26:2008

Appendix A:

EEG 3840 Extra channels (optional)

Beside ECG and surface EMG channels, there are 8 extra channels in EEG 3840. These channels can be the extra EEG channels (as default), or bipolar DC channels, or combination of EEG and DC channels. EEG system according to the customer needs. Please see the below picture as an option.

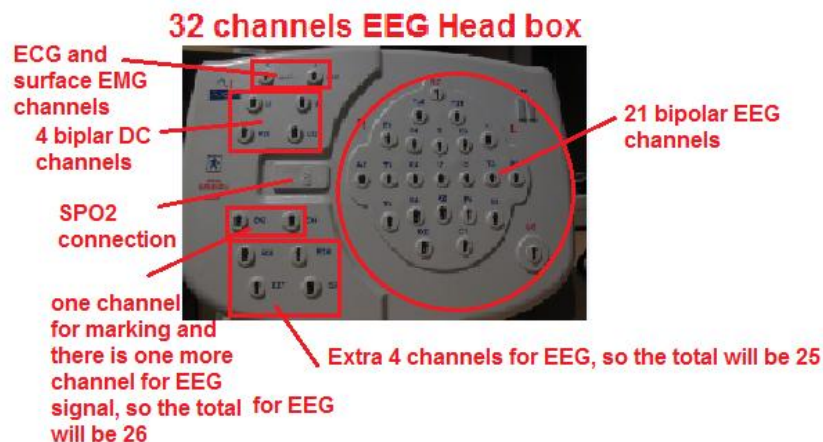

An above picture:

EEG channels:

FP1, FP2, F7, F3, FZ, F4, F8, A1, T3, C3, CZ, C4, T4, A2, T5, P3, PZ, P4, T6, O1, O2, EX5, EX6, EX7, EX8, and they have REF connector at their common references. CG must connect to the wrist by wrist electrode or connect to the shoulder by disposable or disc electrodes.

DC channels:

EX1, EX2, EX3, AND EX4 are DC channels, and each has a references seperetly . Their bipolar connector are according to the below picture:



A means active electrode, and R means reference electrode. We usually use a red color for active electrode and black for reference electrode

Note: to use DC channels , REF electrode on EEG + CG electrode must be connected to the patient even you do not use EEG channels.

Spo2:



This pulse oximeter can be used to adult or infant. The update periode of data is less than 5 second , and has the function of alarming. The main performance of this SPO2 can be listed as:

- Measuring of SPO2, range 0% - %100, Accuracy: 70 – 100%
- Measuring of the Pulse rate, Range: 30bpm – 250 bpm, accuracy: +, - bpm
- bar graph display, amd pulse waveform display
- low voltage indicator, automatically power off function , the display mode, and brightness can be changed
- resistance to surrounding light
- Has rechargeable battery, can be cahrged by USB, or an adaptor, power supply requirement: DC: 3.6-5V
- Optical sensor: red light wave form is 660nm and 6.65mW, and infrared is 880nm, and 6.75mW

Mark channel:

Beside annotation and selection in the EEG software, an extra channel mark is defined as an extra channel in NR SIGN EEG. This cable will be connected to the control box via its cable and can be used as a patient push bottom or as a channel mark by physicians.



According to the customer need all eight extra channels can be programmed as bipolar DC channels by manufacture before shipping the equipment.

- **The extra channels names should be programmed by user before use according to channel rename option . (please refer to section 4-1-1-1 (channel rename)).**

Packaging labeling:



#202, 109 Braid Street,
New Westminster, BC
CA, V3L5H4



90339



89861

CE
579042



FM 550117



preissler Medintechnik
Augsburger Strasse 75, Kaufbeuren,
Germany D-87600

LOT 02



2013-05



EEG 5000Q



EEG 3840



VIDEO OPTION



EMG / NCV 5000Q



EMG / NCV / EP 5000Q



Amendment

How to assemble the EEG 3840 on GCX Trolley



a) Assembly instruction:

1. Please screw photic and head box Arm or holder at first in the trolley
2. Please screw Computer holder on the trolley

3. Please screw computer on its holder
4. Please adjust the holder on the trolley as you desired.
5. At last please connect Head box and photic arms on the holder according to below picture.

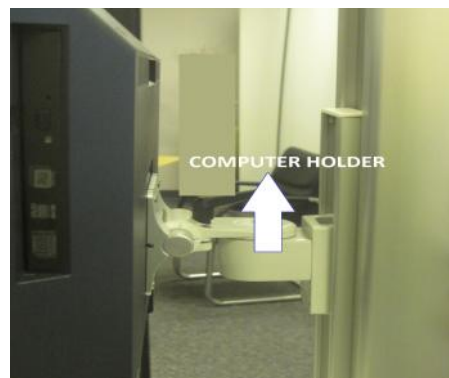
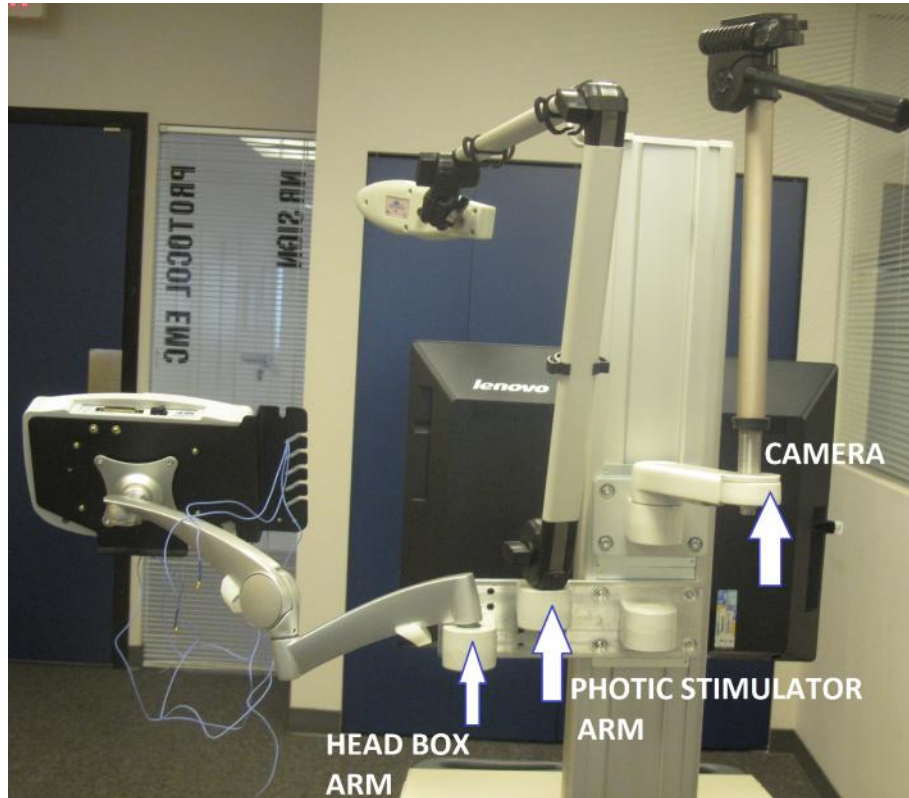

If the patient seat on the chair, the head box should be at the back and Photic stimulator on the front of the patient close to her/his eyes according to below picture.

