

3DEXPERIENCE®

# WHAT'S NEW

## SOLIDWORKS 2021

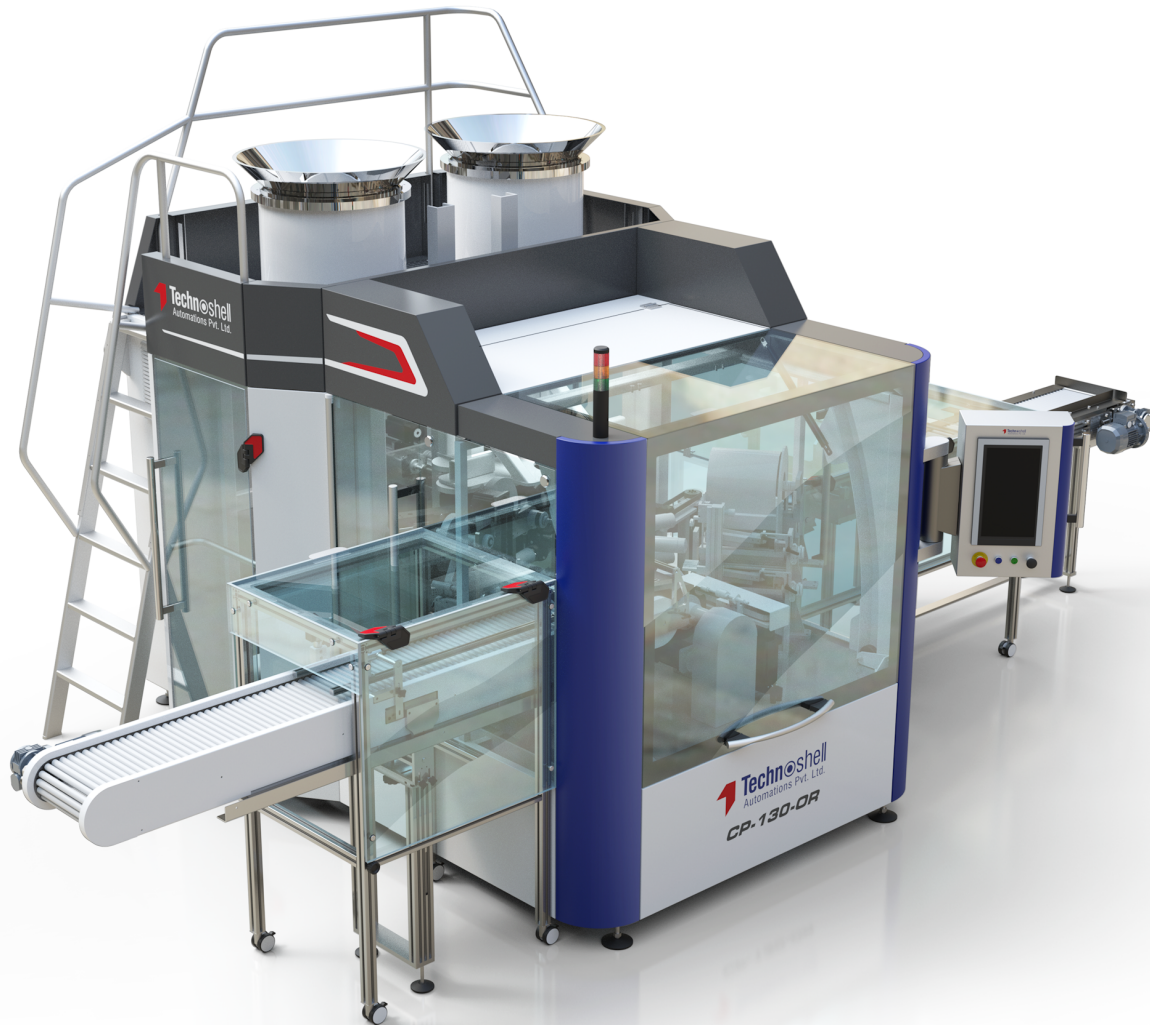

# Contents

---

<b>1 Welcome to SOLIDWORKS 2021</b> .....	<b>7</b>
Top Enhancements .....	8
Performance .....	11
SPR Fixes .....	14
For More Information .....	16
<b>2 Installation</b> .....	<b>18</b>
Download Performance Improvement .....	18
<b>3 Administration</b> .....	<b>19</b>
Apply and Lock Color Settings .....	19
Updated SOLIDWORKS Rx Performance Benchmark Tests .....	20
<b>4 SOLIDWORKS Fundamentals</b> .....	<b>21</b>
Changes to System Options and Document Properties .....	21
Color Selections .....	23
Searching for Commands .....	24
Displaying Translated Feature Names .....	24
Application Programming Interface .....	25
Other Fundamentals Enhancements .....	25
<b>5 User Interface</b> .....	<b>27</b>
Collapsible CommandManager .....	27
Active Window Highlighted .....	28
Accelerated Zoom .....	29
Welcome Dialog Box Background Colors .....	30
Other User Interface Enhancements .....	30
<b>6 Parts and Features</b> .....	<b>32</b>
Adding and Evaluating Equations .....	32
Adding Equations for File Properties .....	33
Redo Support for Part Features .....	33
Transfer Body Material or Part Material .....	34
<b>7 Model Display</b> .....	<b>35</b>
3MF Files .....	35
Picking Color for Appearances from External Applications .....	36
Model Display Performance Improvements .....	37
Semi-Transparent Text for Dimensions .....	38

<b>8 Sheet Metal</b> .....	<b>39</b>
Edge Flanges.....	39
Performance Improvements in Sheet Metal.....	40
<b>9 Structure System and Weldments</b> .....	<b>41</b>
Graphical Manipulator in Structure System .....	41
Correct Cut List Length of Weldment Member .....	42
Trims for End Miter Joints .....	43
Generating Cut List IDs .....	44
<b>10 Assemblies</b> .....	<b>45</b>
Saving a Defeatured Model as a Configuration.....	46
Performance Evaluation Checks for Circular References.....	47
Spacing Options for Chain Patterns.....	47
Auto-Resolving Lightweight Components.....	48
Exporting Interference Detection Results.....	49
Slot Mates.....	50
Synchronizing a Patterned Component to a Seed.....	51
Mate Alignment.....	51
Assemblies Performance Improvements.....	52
Mate PropertyManager.....	52
<b>11 Detailing and Drawings</b> .....	<b>53</b>
Detailing Mode Enhancements.....	53
Context Toolbars and Menus in Drawings.....	54
Location of the Hatch Pattern File.....	55
VDA Balloons.....	56
Performance Improvements in Detailing and Drawings.....	57
<b>12 SOLIDWORKS PDM</b> .....	<b>59</b>
Customizing Columns.....	60
Configuring Column Sets.....	61
Supporting Cut List References in Computed Bill of Materials.....	63
SOLIDWORKS PDM File Explorer Enhancements.....	64
Icon Changes for Workflow States and Transitions.....	65
Treehouse View in the Where Used Tab.....	66
SOLIDWORKS PDM Performance Improvements.....	66
Displaying Derived Part References.....	67
Using Bill of Materials Options Defined in SOLIDWORKS.....	68
<b>13 SOLIDWORKS Manage</b> .....	<b>69</b>
Bill of Materials Enhancements.....	70
Bill of Materials Editing Features.....	71
Task Enhancements.....	72

SOLIDWORKS Manage User Interface Enhancements .....	73
Database Debug Log Viewer .....	74
Promotion Settings for SOLIDWORKS PDM Reference Files .....	75
Multiselect Project Stages and Show Substages Options .....	76
Access to the Capacity Planning Dashboard .....	76
SOLIDWORKS File Preview in the Plenary Web Client .....	77
Thumbnail Utility for SOLIDWORKS PDM Objects .....	78
Access to Numbering Schemes .....	78
Partial Administrators for Dashboards .....	79
Save as Recursive .....	79
Viewer Licenses .....	80
Multi-Language Display Names .....	80
Controlling Field Values .....	81
Optionally Upgrading the Database .....	81
File Sharing Option .....	82
Other SOLIDWORKS Manage Enhancements .....	83
<b>14 SOLIDWORKS Simulation .....</b>	<b>85</b>
Terminology Updates for SOLIDWORKS Simulation .....	86
Contact Stabilization .....	88
Robust Default Interaction Settings .....	91
Improved Bonded Formulation .....	93
Geometry Corrections for Surfaces in Contact .....	94
Switch Source and Target Faces for Local Interactions .....	96
Default Mesh Settings .....	97
Enhanced Blended Curvature-Based Mesher .....	98
Mesh Quality-Diagnostics Tool .....	100
Simulation Solvers .....	101
Improved Post-Processing for Very Large Models .....	103
Simulation Evaluator .....	104
Pin Connector Forces .....	104
Copy Tabular Simulation Results to Clipboard .....	106
Performance Improvements in SOLIDWORKS Simulation Professional and SOLIDWORKS Simulation Premium .....	107
<b>15 SOLIDWORKS Visualize .....</b>	<b>108</b>
Capping Cut Planes .....	109
Draco Compression for SOLIDWORKS Visualize GLTF and GLB Exporter .....	110
Support for SOLIDWORKS Configurations .....	111
Toon Shading .....	112
Displacement Mapping .....	113
Shaders .....	114
User Interface Enhancements for SOLIDWORKS Visualize .....	114
Render Layers .....	115
Viewport Settings Dialog Box .....	117

<b>16 SOLIDWORKS CAM</b> .....	<b>119</b>
Additional Stock Types Available in Stock Manager.....	120
Rebuild Data When Stock Parameters Are Modified.....	121
End Conditions for Part Perimeter Feature.....	122
Modify Path to Post Processors in the Technology Database.....	122
Defining Peck Amounts for Point-to-Point Operations.....	123
Supported Platforms for SOLIDWORKS CAM.....	123
<b>17 SOLIDWORKS Composer</b> .....	<b>124</b>
Controlling the Display of Hidden Edges.....	125
Highlighting of Invisible Actors.....	126
Delete Empty Groups at Import.....	127
Loading Improvements.....	128
Saving Multiple Configurations to SOLIDWORKS Composer Files.....	129
Sharing (Default) Document Properties.....	130
Other SOLIDWORKS Composer Enhancements.....	131
<b>18 SOLIDWORKS Electrical</b> .....	<b>132</b>
Symbols for Terminal Strips.....	133
Associating a Terminal Symbol with a Manufacturer Part.....	133
Associating a Terminal Symbol with a Schematic Terminal Symbol.....	134
Using Specific Symbols in Configurations of Terminal Strip Drawings.....	134
Excluding a Manufacturer Part from a BOM.....	135
Excluding from BOM - Manufacturer Part Properties in the Manager.....	135
Excluding from BOM - Manufacturer Part Properties in the Project.....	135
Excluding from BOM - Using Filter in Report.....	136
Add-In for Excel Automation.....	136
Managing Wires.....	137
Archiver and Scheduling Process.....	138
Archiving with the Environment Archiver.....	138
Scheduling the Archiver Using Windows Task Scheduler.....	138
SOLIDWORKS Electrical Viewer.....	139
Creating Multiple Drawings Simultaneously.....	140
Generating Separate Routing Assemblies of Cables.....	140
Activating the Separate Routing Assembly Parameter for a Cable.....	141
Routing Cables in a Separate Routing Assembly.....	141
Using Splines in Routings.....	141
<b>19 SOLIDWORKS Inspection</b> .....	<b>143</b>
SOLIDWORKS Inspection Add-in.....	143
Template File Locations.....	143
VDA Balloons.....	144
SOLIDWORKS Inspection Standalone.....	144
Grid Improvements.....	145
SOLIDWORKS Part Support.....	145

<b>20 SOLIDWORKS MBD</b> .....	<b>147</b>
Datum Targets .....	147
Bend Tables in 3D PDFs .....	148
<b>21 eDrawings</b> .....	<b>149</b>
Annotations in 3D Views .....	149
File Properties .....	150
Measure .....	151
Measure and Move in Save as eDrawings Web HTML .....	152
<b>22 SOLIDWORKS Flow Simulation</b> .....	<b>153</b>
Free Surface with Rotating System .....	153
Creating Plots from Scene Template .....	154
Filtering Hidden Bodies in Component Control .....	154
Calculating Minimum and Maximum Values from Plots .....	154
Customizing Visualization Parameters .....	154
<b>23 SOLIDWORKS Plastics</b> .....	<b>155</b>
Redesigned PlasticsManager Tree .....	156
SOLIDWORKS Plastics Enhancements .....	157
Multi-Material Overmolding Injection Process .....	158
Enhanced Modeling of Baffles and Bubblers .....	159
Enhanced Modeling of Sketch-Based Runners .....	160
Delay Time Option for Co-Injection Processes .....	161
A-B-A Sequence of a Co-Injection Process .....	161
Access to Material Databases .....	162
Material Database Plots .....	163
Material Library Updates .....	164
Plastics Tutorials .....	166
<b>24 Routing</b> .....	<b>167</b>
Routing Multiple Wires Through Clips .....	168
Location of Tables in Flattened Routes .....	168
Table Properties in Flattened Routes .....	169
Selecting Several Routes for Electrical Attributes .....	170
Keeping Cable Ends at Correct Pin Locations .....	170
Locking Route Segments .....	171
Hiding Empty Pin Rows .....	172
Propagating Termination Type .....	172
Additional Properties Available in the BOMs .....	173
Splicing Without Components .....	173
Selecting Components to Maintain 3D Orientation in Flatten Routes .....	174

# 1

## Welcome to SOLIDWORKS 2021

---

This chapter includes the following topics:

- **Top Enhancements**
- **Performance**
- **SPR Fixes**
- **For More Information**



Model courtesy of Rahul Gawde, SOLIDWORKS 2020 Beta Splash Screen Prize winner.

At SOLIDWORKS, we know that you create great designs, and that your great designs get built. To streamline and accelerate your product development process from concept through manufactured products, SOLIDWORKS 2021 contains new, user-driven enhancements focused on:

- **Expanded functionality.** Defeature simplification for large assemblies, more commands available in Detailing mode for drawings, and additional capabilities for plastics simulations provide new workflow possibilities for design, detailing, and validation.
- **Performance.** Faster mesh generation significantly improves simulation time. More streamlined data management with collaboration reduces errors and project management time, giving you more time for design refinement.
- **Staying Connected.** An improved connection to the **3DEXPERIENCE®** platform provides extensive cloud collaboration, data management, and advanced applications. This ensures you can access the tools and services you need to get your entire job done.

## Top Enhancements

The top enhancements for SOLIDWORKS® 2021 provide improvements to existing products and innovative new functionality.

### Detailing Mode

- Work with improved drawing creation performance
- Take advantage of improvements to adding hole callouts, editing existing dimensions and annotations, and adding detail, break, and crop views

### Assemblies

- Export interference detection reports with images to Microsoft® Excel®
- Use **Change mate alignments on edit** to warn you when mate changes result in errors that can be avoided by flipping the alignment of the edited mate
- Automatically resolve lightweight components on expanding the FeatureManager® node
- Save defeatured models as configurations, change between full and simplified versions, and mimic other configurations
- Benefit from improvements for design tables, exploded views, mates, and mirror and pattern features
- Open, save, and close assemblies with significant performance improvements
- Use curve length in chain patterns along paths, not chord length
- Detect and report circular references

### Model Display

- Work with improved performance of occlusion culling, silhouette edges and drawings, and quick configuration switches

### User Interface

- Pick colors for appearances from external applications
- Search for tools on Shortcut Bars and Commands tabs in the Customize dialog box
- Display translated feature names in the FeatureManager® design tree

### Parts and Features

- Use **Redo** for more than 60 features and tools in parts
- Add edge flanges on nonplanar tangent edges in sheet metal parts and flatten complex flanges
- Add and evaluate equations in file properties and cut list properties
- Transfer part-level materials when you insert or mirror a part, derived component part, or mirrored component part

### SOLIDWORKS Simulation

- Use mesh diagnostics to identify, isolate, and prompt to fix poor-quality elements
- Use faster and more robust meshing with accuracy bonding improvements



- Access improved convergence through contact stabilization
- Get faster contact simulation calculations
- Automatically calculate and apply geometry correction terms for contact between curved surfaces
- Ensure accuracy for bonding interactions to enable robust and fast meshing
- Get a more accurate auto-selection of the equation solver with commensurate improvements in speed and memory usage

### **SOLIDWORKS Electrical**

- Use splines, lines, or other sketch entities to route harnesses in 3D
- Use multiple wires or cables to pass through and arrange through clips
- Join wires using splice component or splice without component
- Access support for end terminations in Connector Tables, Interconnects, and the Accessories Library
- Combine 3D representations and flattened areas in harness board drawings
- Archive electrical projects automatically or by schedule
- Generate PDF files of projects up to nine times faster depending on project size
- Update engineering units for wires, cables, and electrical harness data using the Routing Library Manager (RLM)
- Use the Terminal Types Manager to handle terminals and interconnections
- Bring information on end terminations from SOLIDWORKS Electrical schematics into 3D for more complete documentation
- Fit entire workflows, from schematic to 3D, for wires without end terminations
- Leverage Microsoft Excel for electrical design automation with an add-in to streamline the process

### **SOLIDWORKS Plastics**

- Streamline the plastics simulation workflow with the redesigned PlasticsManager tree
- Improve cooling results accuracy with enhanced baffling and bubbler modeling and meshing
- Access more accurate and up-to-date plastics material data

### **SOLIDWORKS Flow Simulation**

- Calculate free surface for tasks, including rotating equipment

### **SOLIDWORKS Inspection**

- Access quality control information directly from SOLIDWORKS parts containing 3D annotations
- Leverage existing 3D CAD data to save time creating First Article Inspection reports
- Expand drawingless manufacturing strategy for quality control

### **SOLIDWORKS MBD**

- Publish sheet metal bend tables as 3D PDF files

- Define driving and driven locating dimensions as semantically correct datum targets
- Take advantage of improved 3D PDF display quality

### **SOLIDWORKS CAM**

- Control changes by ensuring all necessary information stays current with design changes
- Use cylindrical stock for milling operations
- Specify drill peck amounts based on the drill diameter

### **SOLIDWORKS PDM**

- Use more consistent integration with Microsoft® Windows® File Explorer and better thumbnail support
- Control custom column sets in a more flexible way
- Reduce mistakes and improve efficiency when working with BOM settings
- Save time when modifying bills of materials for use by other fields, such as manufacturing
- Use icon selection for workflow states, and improved transitions to quickly determine the status of a particular file
- Add files to the vault significantly faster
- Access the Treehouse view in the Contains and Where Used tabs
- Save time on Web2 by quickly browsing through data card properties and updating values with modern controls
- Share file data with external users with more efficiency and control
- Streamline project management with multiple projects connected to a common project manager or program
- Use modeless windows to open multiple property card windows and switch between them for editing and data gathering
- Automatically update project stage progress, resources, and deliverables from related task data at specified time intervals

### **3DEXPERIENCE Connector for SOLIDWORKS**

- Use the Derived Format Converter to create derived outputs for broader consumption and exact geometry to use in downstream design, simulation, and manufacturing applications
- Use multiple sheets and markups on drawings, with improved drawings quality
- Manage **Open** tools with similar options to SOLIDWORKS when opening data from the **3DEXPERIENCE**® platform
- Control configurations to save on the **3DEXPERIENCE** platform

Access to Dassault Systèmes User Assistance requires **3DEXPERIENCE** credentials.

## Performance

SOLIDWORKS® 2021 improves the performance of specific tools and workflows.

Some of the highlights for performance and workflow improvements are:

### Installation

SOLIDWORKS 2021 Installation Manager downloads and extracts installation media faster. Internal testing shows that the download time is improved by 25% or more compared to the methods used before SOLIDWORKS 2021.

### Model Display

SOLIDWORKS 2021 improves performance for occlusion culling, silhouette edges, and drawings.

Feature	Areas of Improvement
GPU-based Occlusion Culling	<ul style="list-style-type: none"> <li>• Large Assemblies</li> <li>• Parts opened in Resolved, Large Assembly Settings, and Large Design Review modes</li> <li>• Legacy or nonrender pipelines</li> </ul> <p>Hidden geometry based on view direction and view frustum is not rendered. This boosts the performance and also allows the performance to scale from low-end to high-end GPUs.</p>
GPU-based Silhouette Edges	<ul style="list-style-type: none"> <li>• Large assemblies and parts while in HLR (Hidden Lines Removed), HLG (Hidden Lines Grayed), and Wireframe modes</li> <li>• Shaded with edges and edge modes</li> </ul>
Drawing	<p>The performance is improved for drawings when panning and zooming.</p>
Switching Configuration of Large Assemblies	<ul style="list-style-type: none"> <li>• Large assemblies</li> <li>• Multilevel assemblies with components that have overridden properties (appearance, display mode, visibility, and referred display state)</li> </ul>

### Sheet Metal

Flat patterns use efficient algorithms to identify bend connections. This reduces the time to flatten complex sheet metal bodies with many flanges by about 20-25 times.

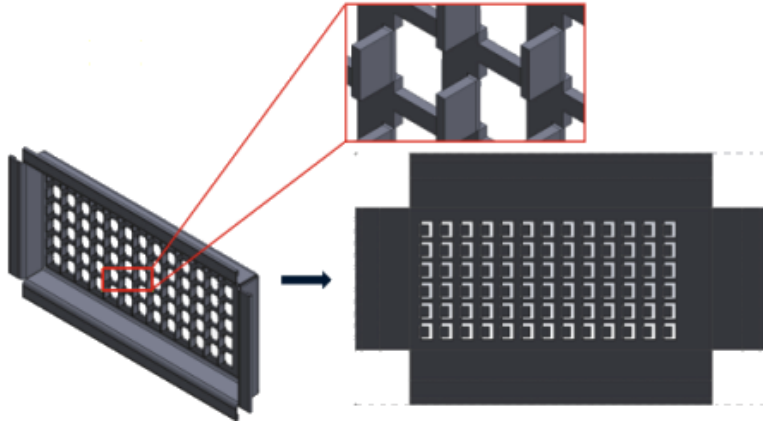

## Assemblies

Assembly performance is improved when:

- Opening resolved and lightweight assemblies
- Opening assemblies with parts that have many configurations
- Updating assemblies that have many mates
- Closing assemblies without saving

## Detailing Mode and Drawings

In Detailing Mode:

- Robust referencing saves you a dramatic amount of time by eliminating the need to resolve and save to maintain final annotation and dimension associativity
- Several new operations help to improve your overall performance while you detail your drawings. See **Detailing Mode Enhancements** on page 53.

For massive drawings, display performance is improved in many areas:

- While sketches are shown:
  - Zoom and pan performance is improved substantially
  - For **Zoom to Area**, the shaded box keeps up with the pointer movement
- Zoom and pan performance is more consistent regardless of zoom scale, for example, when zooming tight versus zooming to fit
- The latency issue that occurred for the first pan is eliminated
- Selecting and moving annotations is improved
- Dynamic highlighting is improved

Performance is also improved when:

- Creating and updating large section views
- Using **Auto Insert** to add center marks when creating section views
- Canceling **Edit Sketch** in broken-out section views
- Creating a detail view in a section view
- Importing a model's cosmetic threads into a view
- HLR background processing for high-quality display of cosmetic threads, by taking advantage of available CPU cores

- Sorting a BOM
- Opening drawing files
- Selecting items in drawings
- Saving a drawing as a .dwg file

## SOLIDWORKS PDM

SOLIDWORKS PDM 2021 has improved performance of file-based operations and related workflows.

- **Add Files, Check-in, and Change State**

Improvements in system performance help you to quickly open, add, check in, and change the state of files with large reference structures. The Add Files operation is between 1.5 and 3 times faster. The Check-in and Change State operations are approximately 25% faster.

The level of improvement can vary depending on the number of files, network bandwidth, and CPU cores.

The Check-in dialog box itself displays much more quickly (in seconds rather than minutes) for very large assemblies or parts with a high number of configurations.

- **Destroy**

You can more quickly destroy files or folders. The operation is many times faster when you are destroying a large number of files.

- **Other Operations and Workflows**

Performance is significantly improved for the following operations:

- For folders containing a very large number of files:
  - Check-in and Check-out of a file
  - Adding a new file by dragging or by copying and pasting
  - Creating a new file from a template
- For assemblies with a large number of components at a single level, when working in SOLIDWORKS:
  - Opening files
  - Saving files
  - Switching windows
- Editing a target file name in the Copy Tree dialog box in a high-latency environment
- Using Copy Tree when a user setting is added to clear variable values

## Simulation

The performance of simulation solvers is improved for linear static and nonlinear studies.

- **FFEPlus Iterative** and **Large Problem Direct Sparse** solvers:

The solution time is improved by using parallel multicore processing to calculate the stiffness for surface-to-surface elements that are in contact.

The transfer of stiffness data between the preconditioning and equation solving steps is optimized because file-based processing is replaced with function-based processing.

These performance gains are more apparent for large models that have at least 10% of the total elements in contact.

- **Intel Direct Sparse** solver:

The solver can handle significantly larger linear and nonlinear simulation studies by taking full advantage of available memory. When the solver exceeds the available memory, it uses available disk space to run the simulation.

The solver can run simulations for linear static and nonlinear studies with more than 4 million equations.

- **Automatic Solver Selection:**

The default option for linear static studies considers the number of equations, load cases, and available system memory to optimize the selection of the best equation solver (**Intel Direct Sparse** or **FFEPlus**).

- **Shell Manager:** Performance is improved when editing a large number of shells.
- **Load Case Manager:** Performance is improved when defining sensors to track simulation results.

## SPR Fixes

We have fixed a large number of Software Performance Reports (SPRs) in SOLIDWORKS 2021 by development projects specifically selected to address quality and performance issues reported by customers.

See the full list of [fixed SPRs](#).

SPR	Resolution
1173747	If you open an assembly in Large Design Review mode with <b>Scroll selected item into view</b> selected, then select multiple entities in the graphics area, the FeatureManager design tree only scrolls the last item into view.

---

**SPR Resolution**

418002,  
444908,  
477042,  
515495,  
622837,  
804884,  
915862

Sheet metal:

- Flat pattern corner treatments use updated algorithms to correctly identify corner geometry and apply appropriate corner treatments to avoid sharp cuts and notches.
- Fixed issues for mirrored and derived parts to create proper corner treatments.

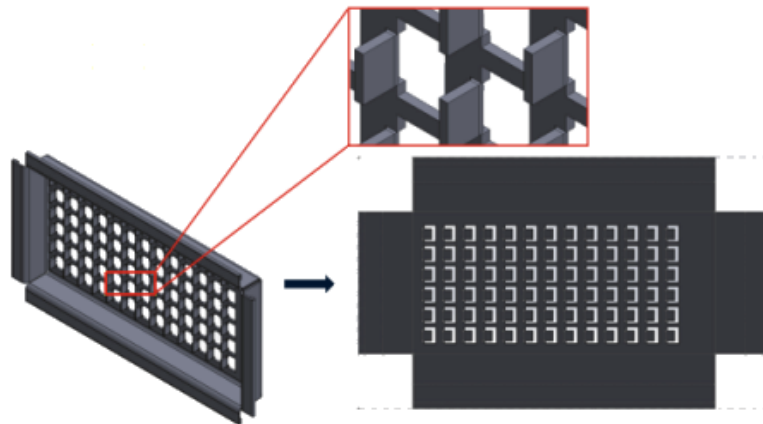

- Assembly features can propagate to individual components even if there are multiple instances of the same part in the assembly. Sheet metal parts created in SOLIDWORKS 2013 and later did not support this functionality.

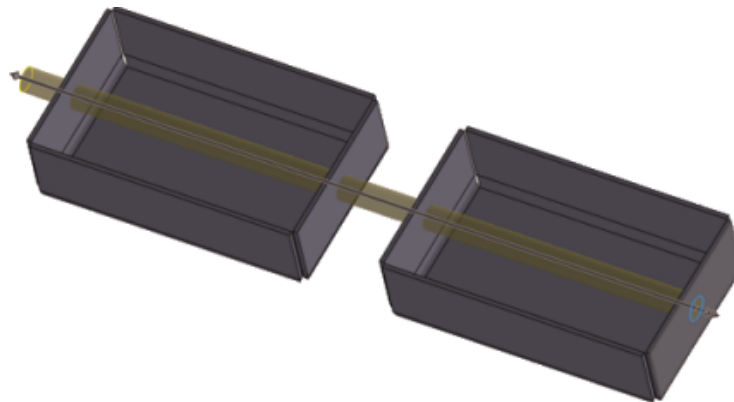

277376 Cosmetic threads are no longer visible if they are on the back side of a model.

627329 While you are adding a dimension, the preview of the dimension is now semitransparent so you can see the geometry under the preview.

SPR	Resolution
617225, 678924, 1015070, 1032525, 1125484, 923080, 1159398	SOLIDWORKS PDM: <ul style="list-style-type: none"> <li>• In the reference dialog boxes, the preference you select for <b>Show Tree Lines</b> is retained across sessions.</li> <li>• In the Bill of Materials tab, the thumbnail previews are larger.</li> <li>• In the file list, the file size is displayed in a single unit for ease of comparison and is consistent with Microsoft® Windows® File Explorer.</li> <li>• In the file view tabs, the quality of thumbnail images has improved significantly.</li> <li>• In the Preview tab, a thumbnail preview is available for DWG and DXF format files.</li> <li>• In SOLIDWORKS PDM File Explorer, file lists follow the sort preference (numeric or literal) specified for Windows File Explorer.</li> <li>• In the Contains and Where Used tabs, when you expand a file node, only the immediate child references are displayed.</li> </ul>
953237, 1070099, 1105835, 518149	SOLIDWORKS PDM: <ul style="list-style-type: none"> <li>• Fixed issues in the execution of the <b>Copy as Path</b> command.</li> <li>• Fixed issues with <b>Get Latest Version</b> of a file that had versions cold-stored, was rolled back, and was recreated on a replicated server.</li> <li>• Fixed issues in the CSV format export of Bills of Material that had special characters, such as comma or double quotes, in the description field.</li> <li>• You can now select the option to look for mandatory values only in the @ tab for SLDDRW files.</li> </ul>
1150640, 1156689, 1156701, 1156718	SOLIDWORKS PDM: <ul style="list-style-type: none"> <li>• Check-in of drawings with user-defined references are now faster.</li> <li>• The display of files with large data sets is now faster in the Bill of Materials and Contains tab.</li> <li>• The performance of the <b>Change State</b> operation is improved.</li> </ul>

## For More Information



Use the following resources to learn about SOLIDWORKS:

### What's New in PDF and HTML

This guide is available in PDF and HTML formats. Click:

- **Help > What's New > PDF**
- **Help > What's New > HTML**

### Interactive What's New

In SOLIDWORKS,  appears next to new menu items and the titles of new or significantly changed PropertyManagers. Click  to display the topic in this guide that describes the enhancement.



To enable Interactive What's New, click **Help > What's New > Interactive**.

**Online Help**

Contains complete coverage of our products, including details about the user interface, samples, and examples.

**Release Notes**

Provides information about late changes to our products, including changes to the *What's New* book, online help, and other documentation.

**Legal Notices**

SOLIDWORKS Legal Notices are available [online](#).

# 2

## Installation

---

### Download Performance Improvement

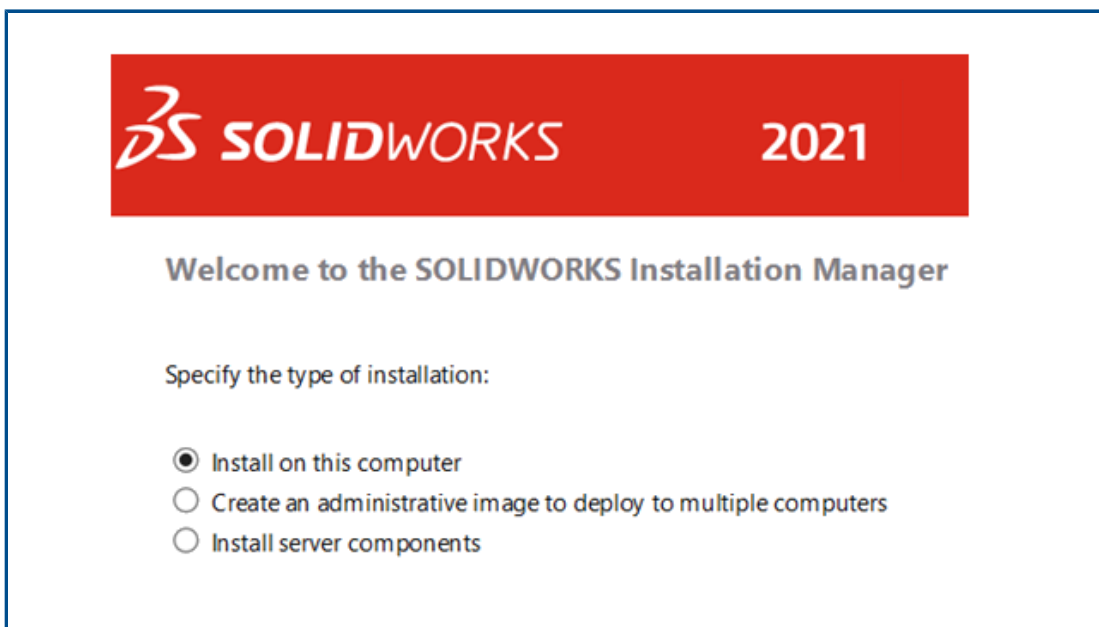

SOLIDWORKS 2021 Installation Manager downloads and extracts installation media faster than earlier versions of the Installation Manager. Internal testing shows that total download times improve by 25% or more compared to the methods used before SOLIDWORKS 2021.

# 3

## Administration

---

This chapter includes the following topics:

- **Apply and Lock Color Settings**
- **Updated SOLIDWORKS Rx Performance Benchmark Tests**

### Apply and Lock Color Settings

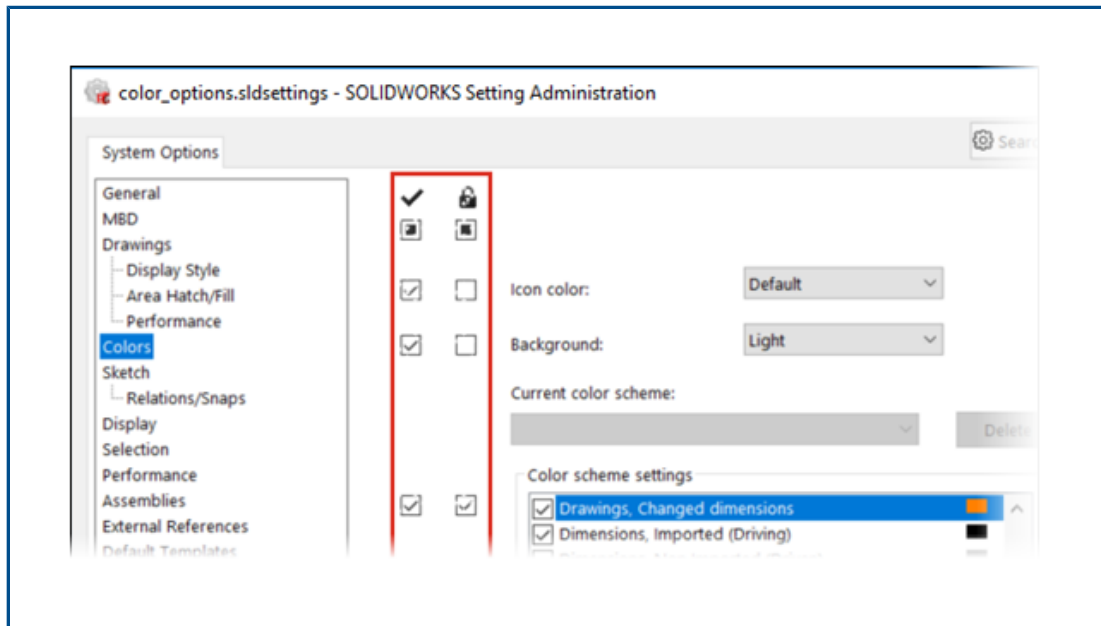

Administrators can use the SOLIDWORKS® Settings Administrator tool to apply and lock color settings either for the first session of SOLIDWORKS or for every session. They can lock those colors to prevent users from changing them and control the background appearance.

Administrators can lock only the active color and background appearance. Users cannot change these settings. Inactive settings are not affected. If a color or background appearance is locked, then users cannot change their color scheme.

To access the Settings Administrator tool, run the tool from the location where you stored the administrative image.

## Updated SOLIDWORKS Rx Performance Benchmark Tests

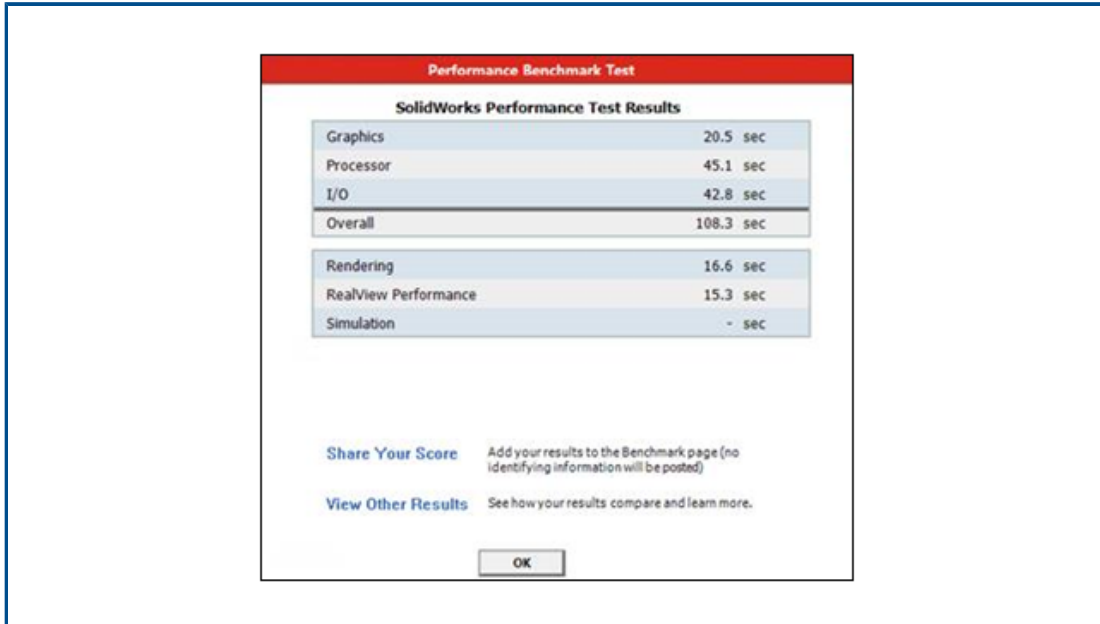

Updates to the Performance Benchmark Test make it easier to compare the graphics performance between computers.

**System Options > Performance > Enhanced graphics performance** is enabled by default. Specifying this option ensures uniform results in the graphics and RealView tests across benchmark systems.

Because of these changes, you cannot compare graphics and RealView performance between SOLIDWORKS 2021 and earlier versions using the Performance Tests. You can only make comparisons between two systems running the same version of SOLIDWORKS.

# 4

## SOLIDWORKS Fundamentals

---

This chapter includes the following topics:

- **Changes to System Options and Document Properties**
- **Color Selections**
- **Searching for Commands**
- **Displaying Translated Feature Names**
- **Application Programming Interface**
- **Other Fundamentals Enhancements**

### Changes to System Options and Document Properties

The following options have been added, changed, or removed in the software.

#### System Options

Option	Description	Access
<b>Use English language feature and file names</b>	The option is independent of <b>Use English language menus</b> .	<b>General</b>
<b>Enable VSTA version 3.0</b>	Removed from the dialog box. VSTA components are installed by default. They are no longer optional.	<b>General</b>
<b>Hatch Pattern File</b>	Specifies a different location for the hatch pattern file ( <code>sldwks.ptn</code> ).	<b>File Locations</b>
<b>Inspection Project Template Folder</b>	Under <b>Show folders for</b> , specifies the search path.	<b>File Locations</b>
<b>Inspection Report Template Folder</b>	Under <b>Show folders for</b> , specifies search path.	<b>File Locations</b>
<b>Prompt before changing mate alignments on edit</b>	Replaced by <b>Change mate alignments on edit</b> . To determine when you receive the warning, specify <b>Always</b> , <b>Prompt</b> , or <b>Never</b> .	<b>Assemblies</b>

Option	Description	Access
<b>Auto-rotate view normal to sketch plane on sketch creation and sketch edit</b>	Enabled by default.	<b>Sketch</b>
<b>Color scheme settings</b>	Two new color options, <b>Selected Item 5</b> and <b>Selected Item 6</b> , are available.	<b>Colors</b>
<b>Show translated feature names in FeatureManager tree</b>	Display features names in a selected language in the FeatureManager® design tree.	<b>FeatureManager</b>
<b>Update component names when documents are replaced</b>	Removed from system options.	<b>External References</b>

## Document Properties

Option	Description	Access
<b>Slot mates</b>	Specifies a default constraint type. Available options are <b>Free</b> , <b>Center Along Slot</b> , <b>Distance Along Slot</b> , and <b>Percent Along Slot</b> .	<b>Mates</b>
<b>Generate Cut list IDs</b>	Specifies a property ID to support 3DEXPERIENCE® PLMServices for <b>Structure Cut Lists</b> , <b>Sheet Metal Cut Lists</b> , and <b>Generic Cut Lists</b> .	<b>Weldments</b>

## Color Selections

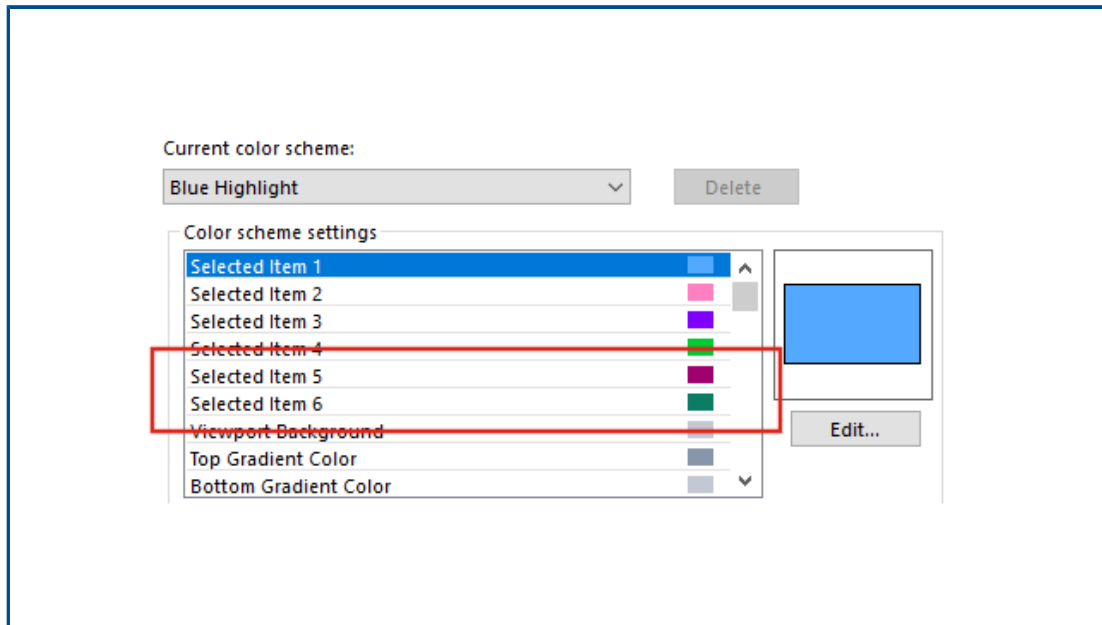

Two new color options, **Selected Item 5** and **Selected Item 6**, are available for color settings.

Under **Color scheme settings**, the **Selected Item** color options moved to the top of the list. **Selected Item 1** is the default color scheme and the selected color appears to the right of each color option.

To select a color, click **Options > System Options > Colors**. Under **Color scheme settings**, select an option.

## Searching for Commands

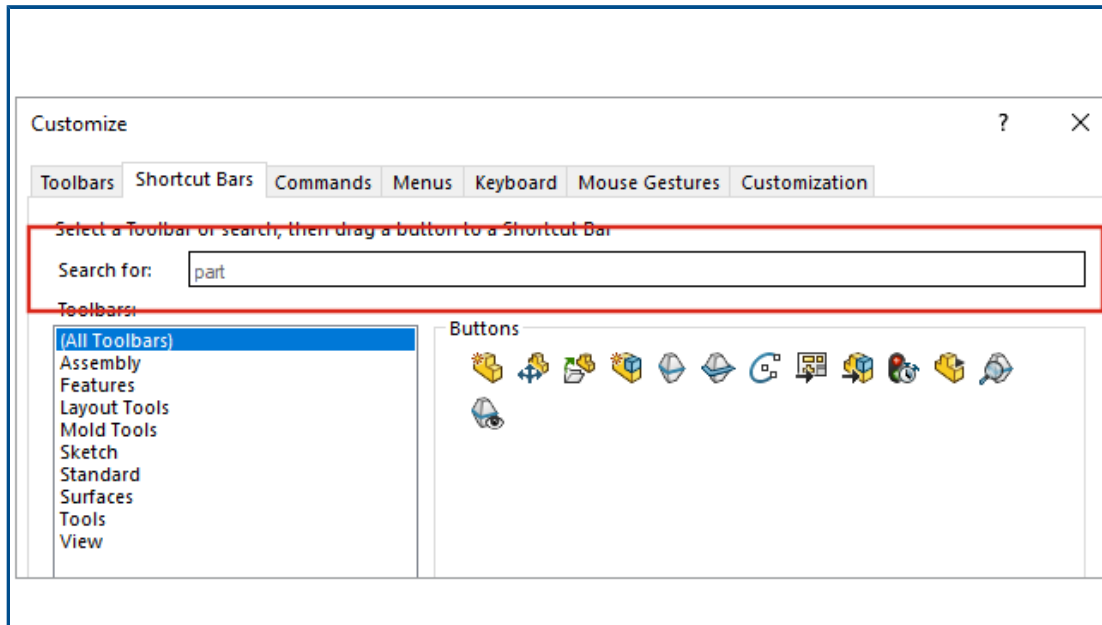

You can search for commands on the **Shortcut Bars** and the **Command** tabs in the Customize dialog box.

To search for a command, click **Tools** > **Customize** > **Shortcut Bars** or **Tools** > **Customize** > **Customize** and enter a command name. Matching commands appear in the Buttons box.

## Displaying Translated Feature Names

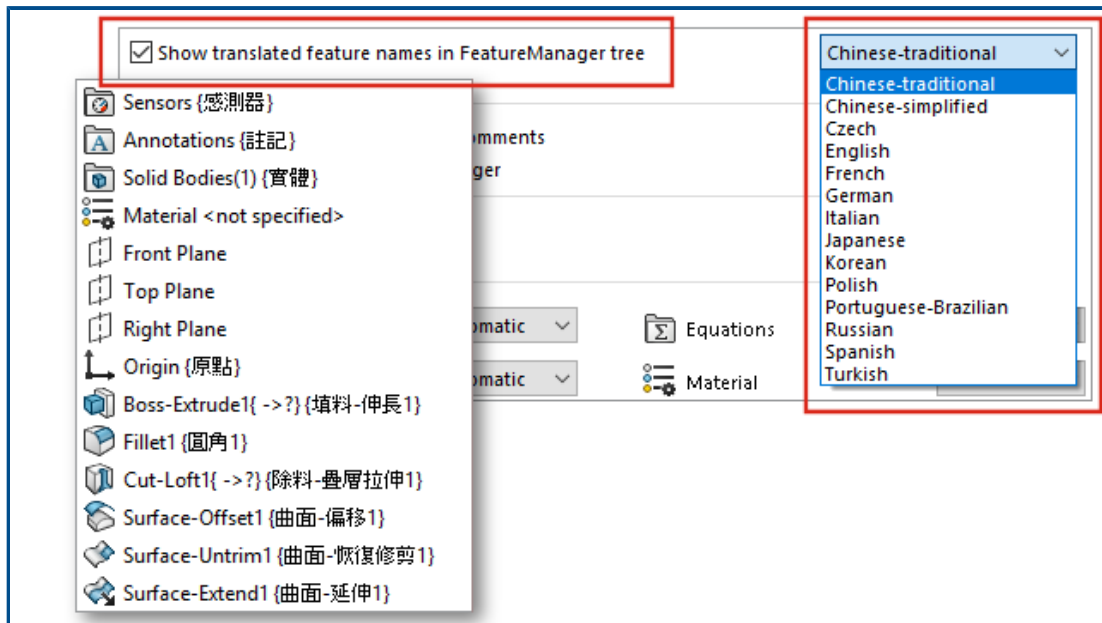



You can use a system option to show translated features names in the FeatureManager® design tree.

Click **Options > System Options > FeatureManager**. Select **Show translated feature names in FeatureManager tree** and select a language.

This option replaces the **Show Translated Feature Name in Tooltip** option under **Tree Display**.

## Application Programming Interface

See *SOLIDWORKS API Help: Release Notes* for late-breaking updates.

### Enhancements

- Create and modify sheet metal swept flanges, optionally using gauge table parameters.
- Vary the dimensions and locations of pattern instances in linear and circular patterns of parts and assemblies.
- Get or set whether to synchronize the configurations of pattern components by configuring the seed component in assembly component patterns.
- Insert chain dimensions in drawing documents.
- Change the type of existing assembly mates.
- Export a Microsoft® Excel® spreadsheet of results during interference detection.
- Handle an event that occurs when you change the file type in the **File > Save As** dialog box.

## Other Fundamentals Enhancements

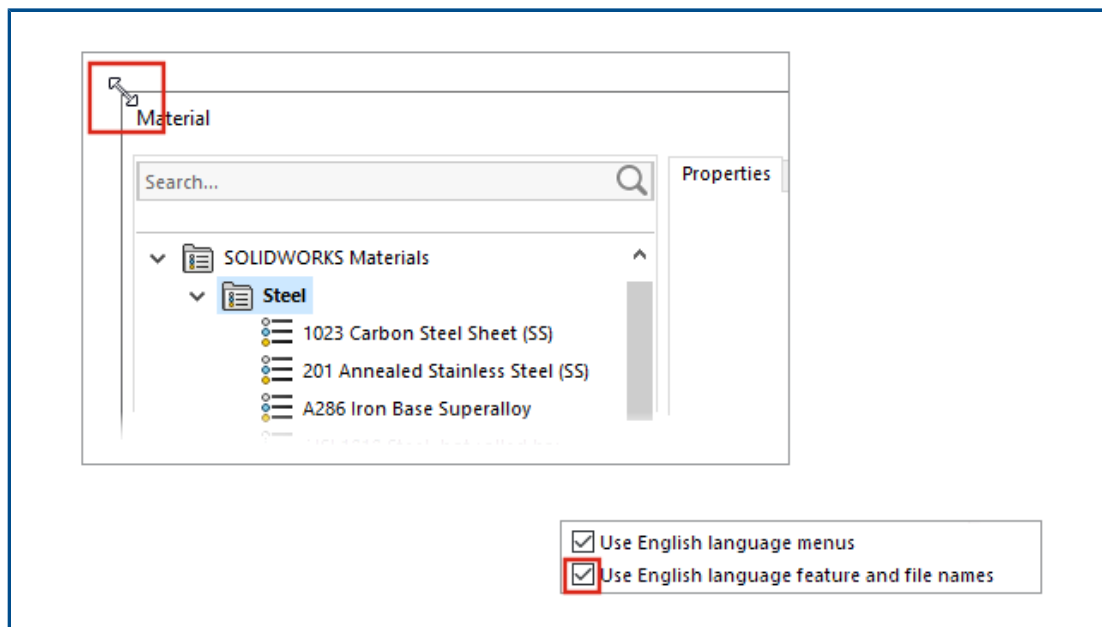

Other enhancements for fundamentals include user interface improvements.

- You can resize the Materials dialog box. In the dialog box, **Open** is renamed to **Add**. This option is available when SOLIDWORKS Simulation is active.
- You can select **Use English language feature and file names** independently from **Use English language menus**. Click **Options > System Options > General** to select these options.
- **Quick Copy** is removed from the Measure tool. To copy a numeric value, double-click the numeric value and press **CTRL+C**.
- Help opens in your default browser.
- For Search, the following options under MySolidWorks are removed:
  - Knowledge Base
  - Community Forum
  - Blogs
  - CAD Models
  - Training
  - YouTube
  - Twitter

# 5

## User Interface

---

This chapter includes the following topics:



- **Collapsible CommandManager**
- **Active Window Highlighted**
- **Accelerated Zoom**
- **Welcome Dialog Box Background Colors**
- **Other User Interface Enhancements**

	<p><b>Video: What's New in SOLIDWORKS 2021 - User Experience</b></p>
--	--

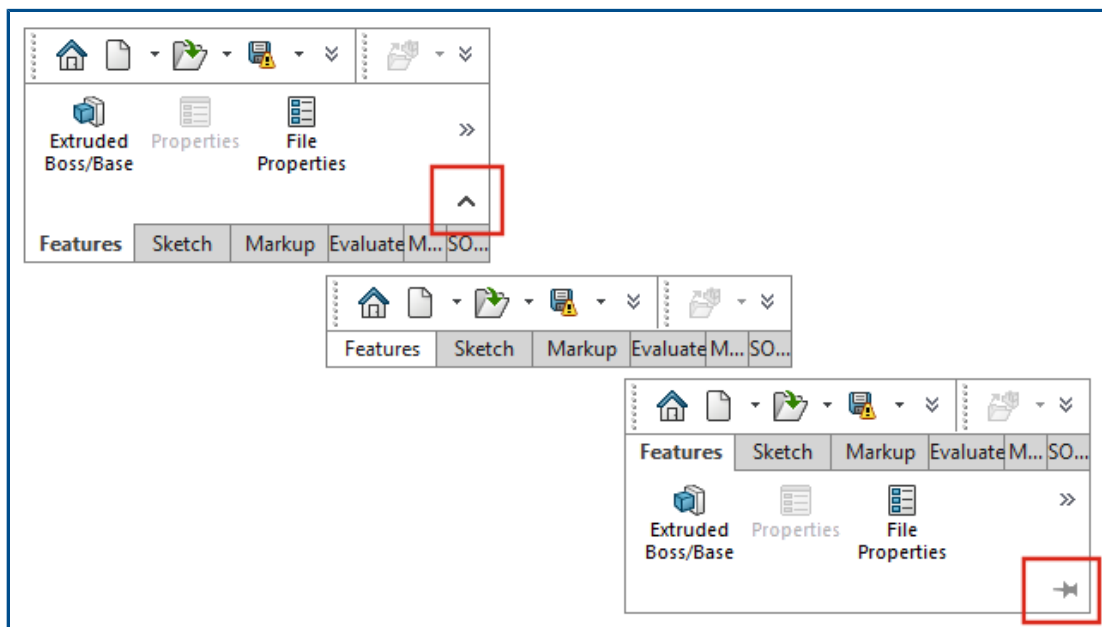
### Collapsible CommandManager



You can collapse the CommandManager to show only the tabs until you want to access the tools.

To collapse the CommandManager, click . In the collapsed view, click a tab to expand the CommandManager and access the tools. In the expanded view, click  to keep the CommandManager expanded.

## Active Window Highlighted

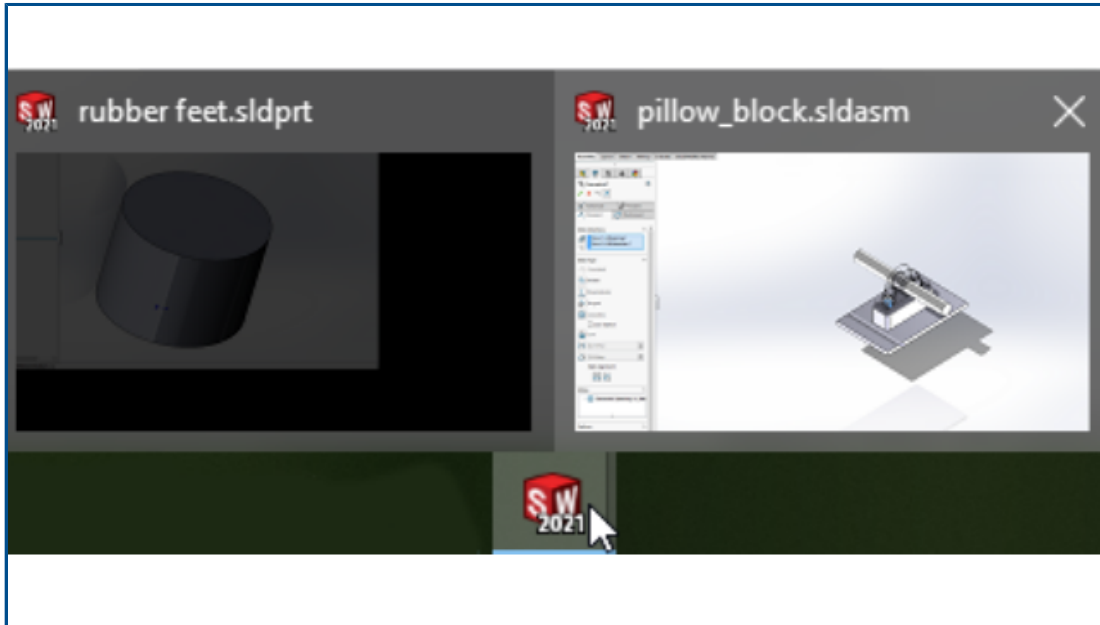

When you have multiple windows open and you hover over the SOLIDWORKS® icon in the taskbar, the window with an open PropertyManager shows as the active thumbnail. You must close the PropertyManager before you can select a different window.

In some cases, an open PropertyManager does not prevent you from switching windows. All thumbnails are active when you hover over the icon.

## Accelerated Zoom

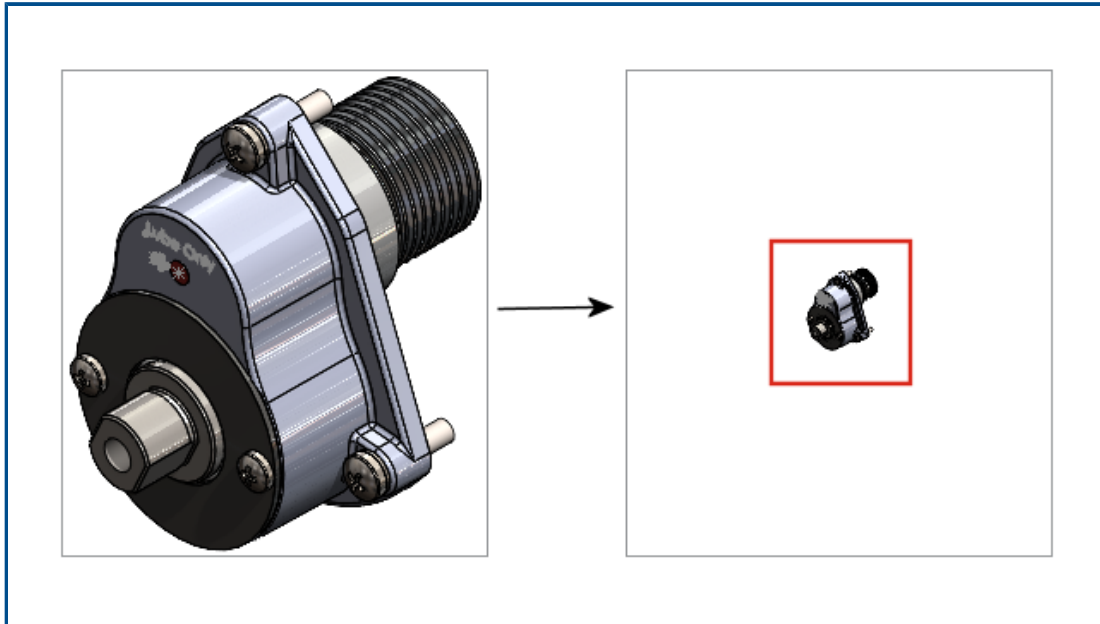

In the graphics area, you can press **Shift** + mouse wheel for accelerated zooming.

To use accelerated zoom:

1. Close all documents.
2. Click **System Options > Display**.
3. Clear **Display scrollbars in graphics view for parts and assemblies**.
4. In an open document, press **Shift** + move the mouse wheel and zoom in or out.

## Welcome Dialog Box Background Colors

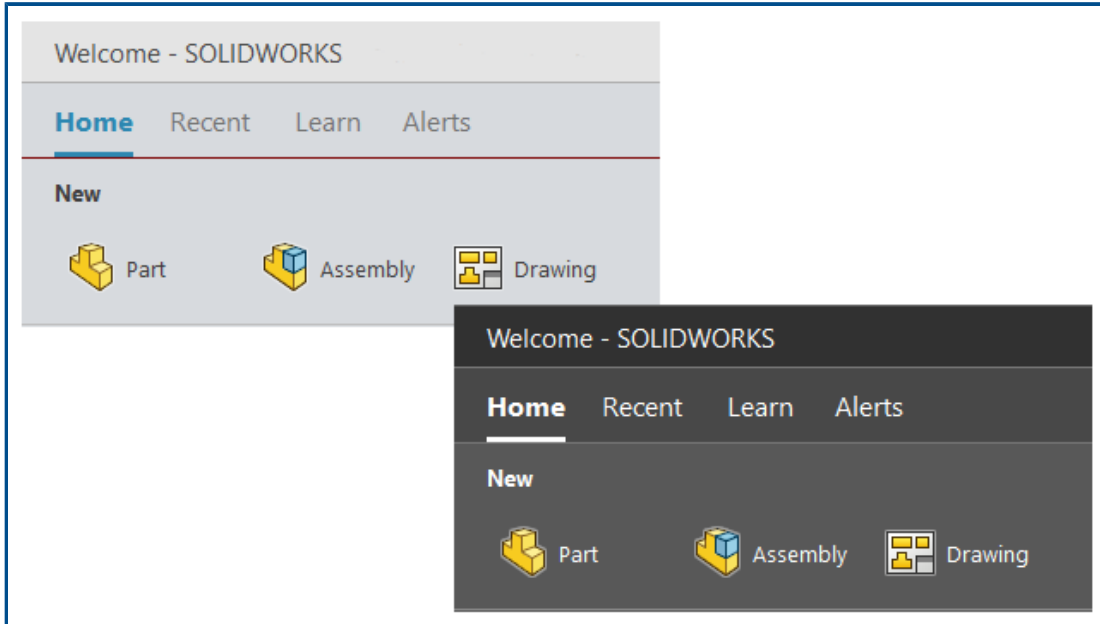



The brightness of the Welcome dialog box varies according to the selected background.

To change the background, click **Options** > **System Options** > **Colors** and select an option for **Background**.

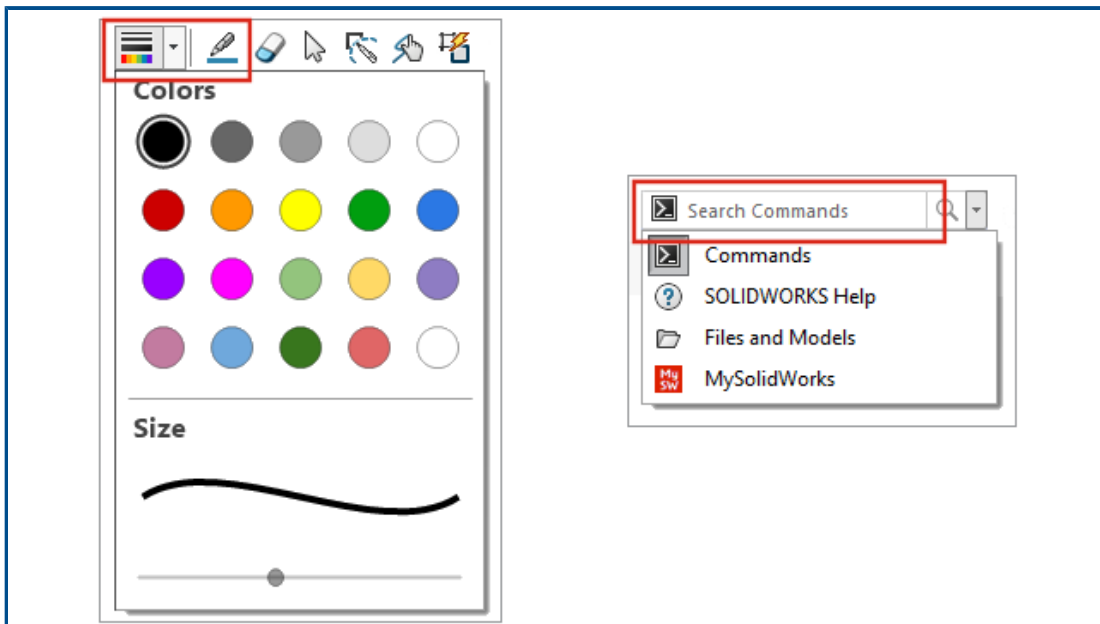
## Other User Interface Enhancements



Other enhancements for user interface include a default search option and renamed Sketch Ink tools.

- On the Sketch Ink toolbar, **Pen**  is renamed to **Draw**. To change the color or the thickness of the line, click **Color** .
- **Commands** is the default option in the search menu.
- When you modify a dimension, the Modify dialog box opens before the Dimension PropertyManager.
- **Auto-rotate view normal to sketch plane on sketch creation and sketch edit** is enabled by default. To clear this option, click **Tools > Options > System Options > Sketch**.

# 6

## Parts and Features

---

This chapter includes the following topics:

- **Adding and Evaluating Equations**
- **Redo Support for Part Features**
- **Transfer Body Material or Part Material**

	<b>Video: What's New in SOLIDWORKS 2021 - Parts</b>
---	---

### Adding and Evaluating Equations

Summary Information

Summary Custom Configuration Specific

Apply to:  Default<As Machined> BOM quantity: - None -

	Property Name	Type	Value / Text Expression	Evaluate
1	Cost - Material Cost	Equatic	"SW-Mass@@Default<As Machined>@Multi	3,80
2	<Type a new proper	Text Date Number Yes or no Equation		

You can add and evaluate equations in file properties and cut list properties.

You can add equations in the following dialog boxes:

- Custom Properties



- Configuration Specific Properties
- Weldment Cut List Properties
- Sheet Metal Cut List Properties

## Adding Equations for File Properties



### To add equations in file properties:

1. Click **File > Properties**.
2. In either **Custom** or **Configuration Specific**, in **Type** select **Equation**.
3. Add a term to the equation by doing one of the following:
  - Enter a number or a conditional statement.
  - On the **Value/Text Expression** tab, select a **Global Variables, Functions, or File Properties**.
  - Use  $\$PRP$  and any **File Property** to include in the equation.

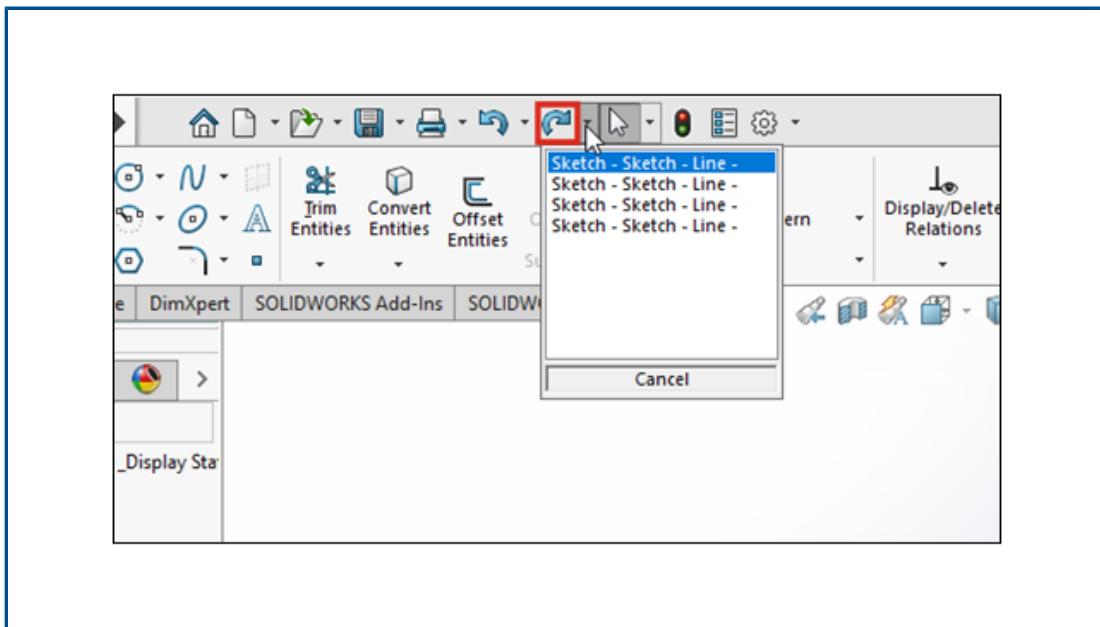
## Redo Support for Part Features



You can use **Redo**  for more than 60 features and commands in parts. Previously, **Redo** was only available in sketches.

You can reverse multiple **Undo**  changes by clicking  next to **Redo**, and selecting an item on the list.

Not all part commands support **Redo** in SOLIDWORKS 2021. Exceptions include:

- Annotations
- Hole features
- Instant3D modifications
- Mold tools

- Sheet Metal
- Weldments

## Transfer Body Material or Part Material

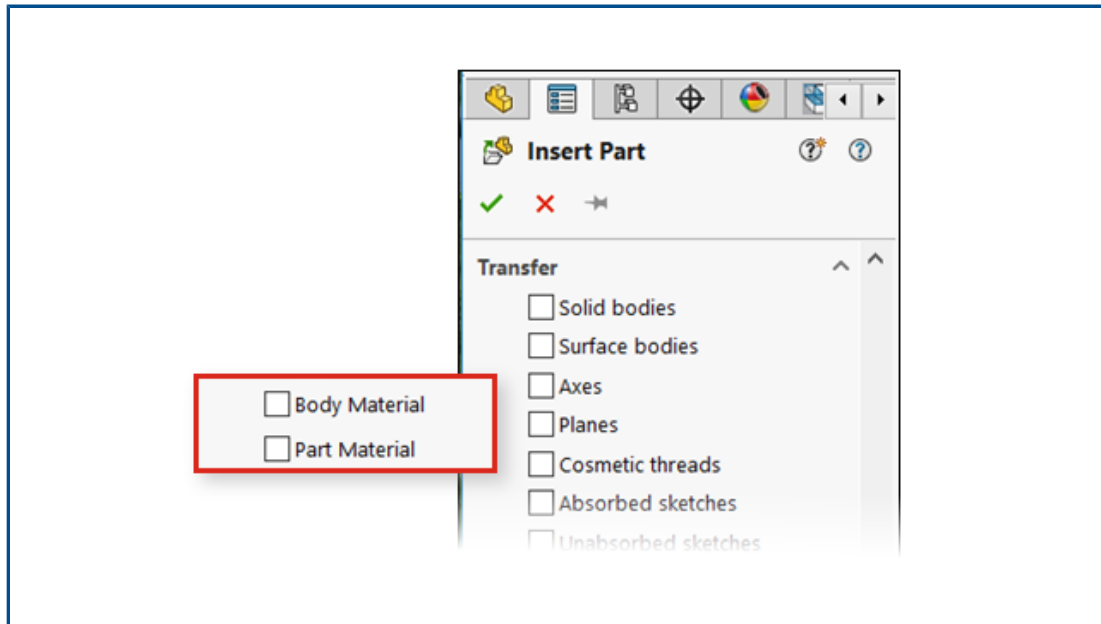

You can transfer body material or part material when you insert or a part, a derived component part, or a mirrored component part.

Previously, the Insert Part PropertyManager provided only **Material** as an option for transferring material. For mirror legacy files, material properties are mapped to **Body Material**.

# 7

## Model Display

---

This chapter includes the following topics:

- **3MF Files**
- **Picking Color for Appearances from External Applications**
- **Model Display Performance Improvements**
- **Semi-Transparent Text for Dimensions**

### 3MF Files

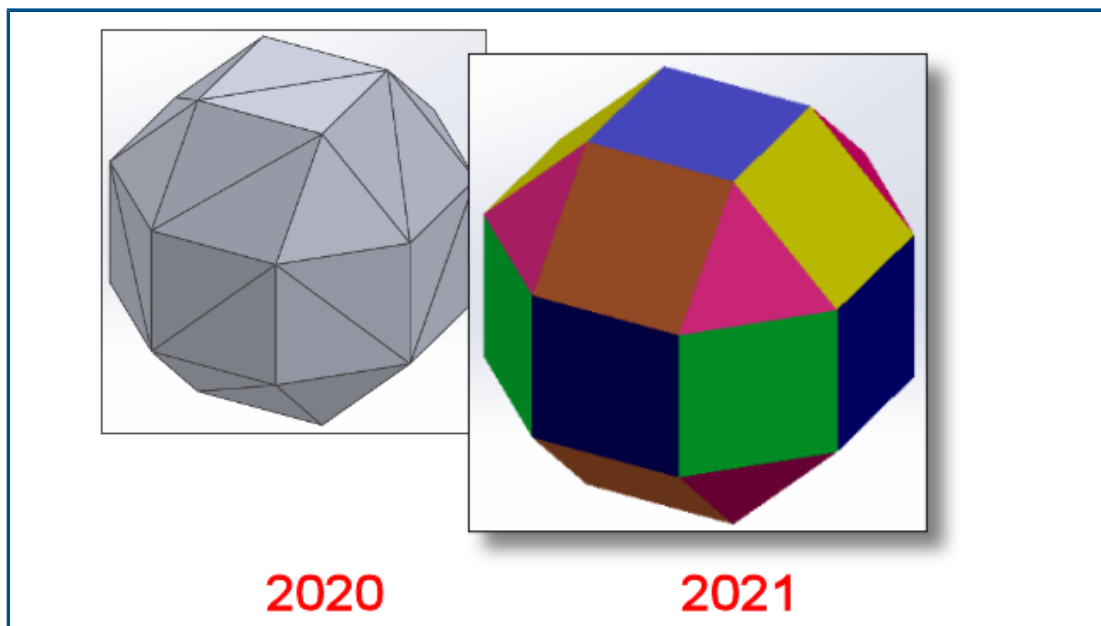

SOLIDWORKS® 2021 features extended graphical support for 3MF files.

3MF is an industry consortium working to define a 3D printing format that allows design applications to send full-fidelity 3D models to a mix of other applications, platforms, services, and printers.

The following graphical items appear in SOLIDWORKS when you import 3MF files:

Items	Graphics body	Mesh BREP (open or closed)	Classic BREP (solid or open)
Per-vertex coloring	Yes	No	No
Per-facet coloring	Yes	No	Yes
Decals	Yes	No	No
Textures	Yes	No	No
Transparency	Yes	Yes	Yes

The following graphical items are exported from SOLIDWORKS to the 3MF format:

- The color of procedural appearances
- Textures of all mapping types such as UV mapping, projection mapping, cylindrical mapping, box mapping, and spherical mapping
- Transparency

### Picking Color for Appearances from External Applications

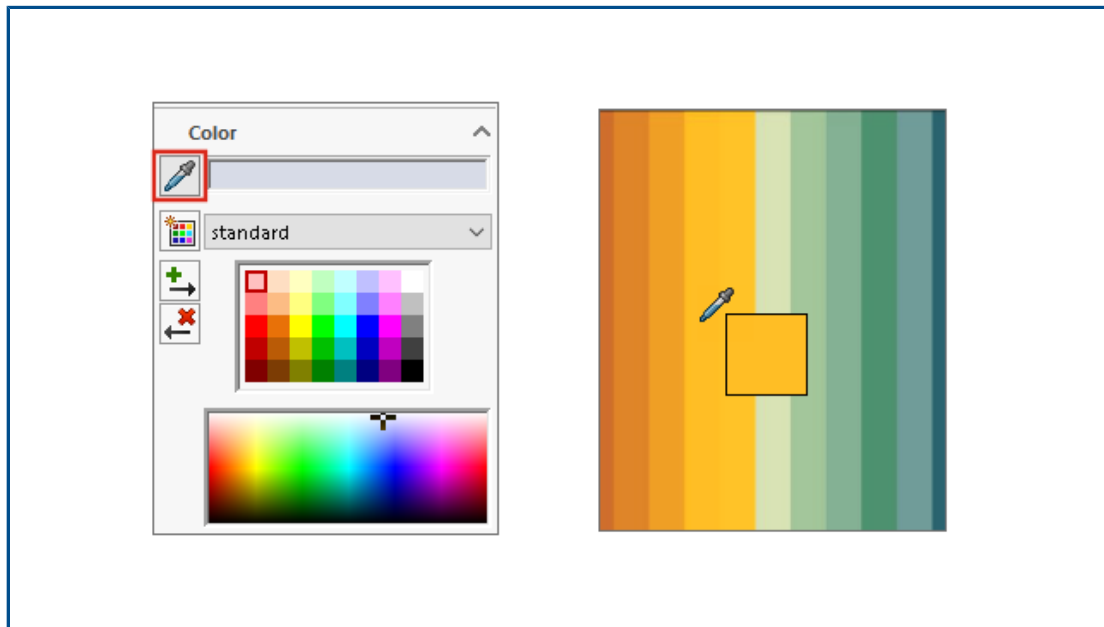

You can click and drag the dropper icon to pick a color from external applications for appearances.

## Model Display Performance Improvements

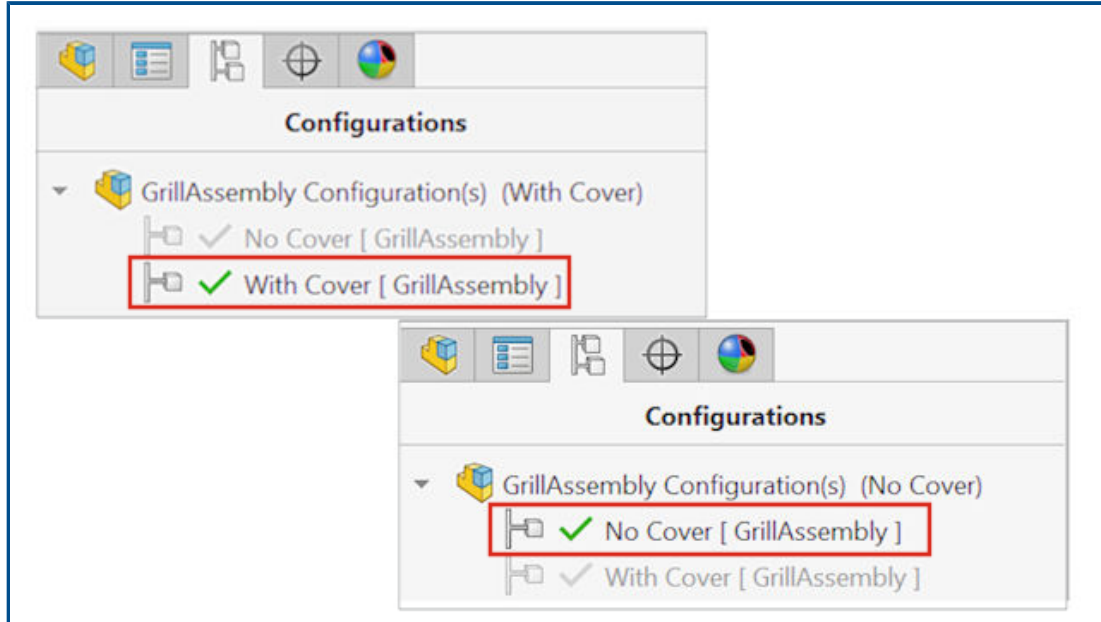

SOLIDWORKS 2021 offers improved performance for occlusion culling, silhouette edges, and drawings. You can switch configurations quickly.

Feature	Areas of Improvement
GPU-based Occlusion Culling	<ul style="list-style-type: none"> <li>• Boosts dynamics performance for large assemblies and parts in resolved, LAM, and LDR (Large Design Review) modes.</li> <li>• Legacy or nonrender pipelines</li> </ul> <p>Hidden geometry based on view direction and view frustum is not rendered.</p> <p>Performance scales with low-end to high-end GPUs.</p>
GPU-based Silhouette Edges	<ul style="list-style-type: none"> <li>• Large assemblies and parts while in HLR (Hidden Lines Removed), HLG (Hidden Lines Grayed), and Wireframe modes</li> <li>• Shaded with edges and edge modes</li> </ul>
Drawing	<p>The performance is improved for drawings when panning and zooming.</p>
Switching Configuration of Large Assemblies	<ul style="list-style-type: none"> <li>• Large assemblies</li> <li>• Multilevel assemblies with components that have overridden properties (appearance, display mode, visibility, and referred display state)</li> </ul>

## Semi-Transparent Text for Dimensions

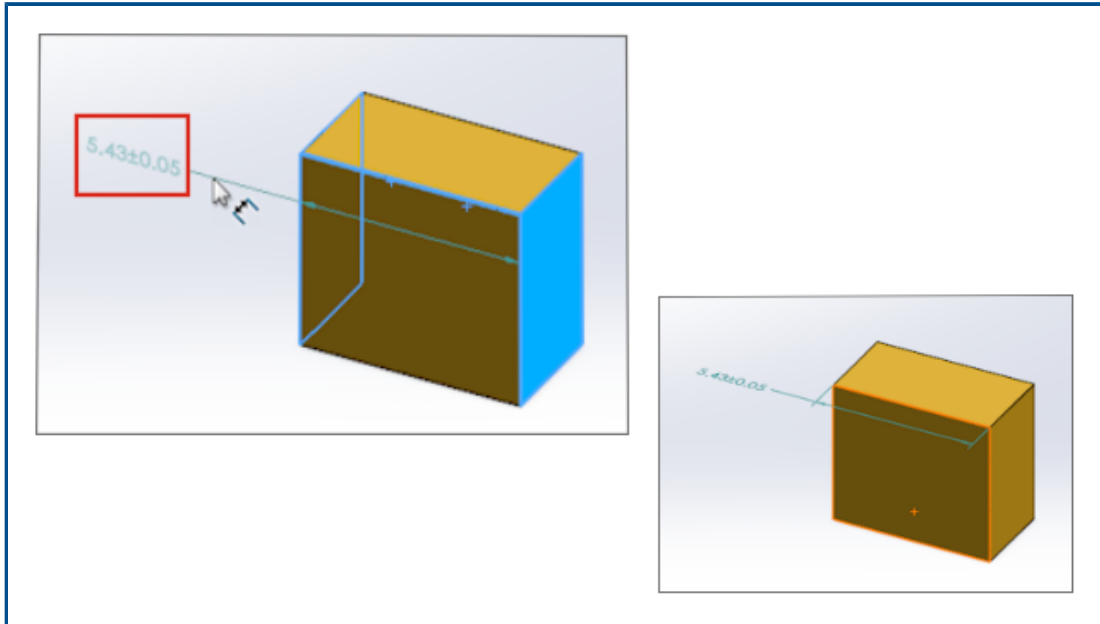

When you use **Smart Dimension** to define dimensions, the dimension text is semi-transparent during placement. You can see and select geometry that is behind the dimension text.

Once you define the dimension, the dimension text is fully visible.

# 8

## Sheet Metal

---

This chapter includes the following topics:

- **Edge Flanges**
- **Performance Improvements in Sheet Metal**

### Edge Flanges

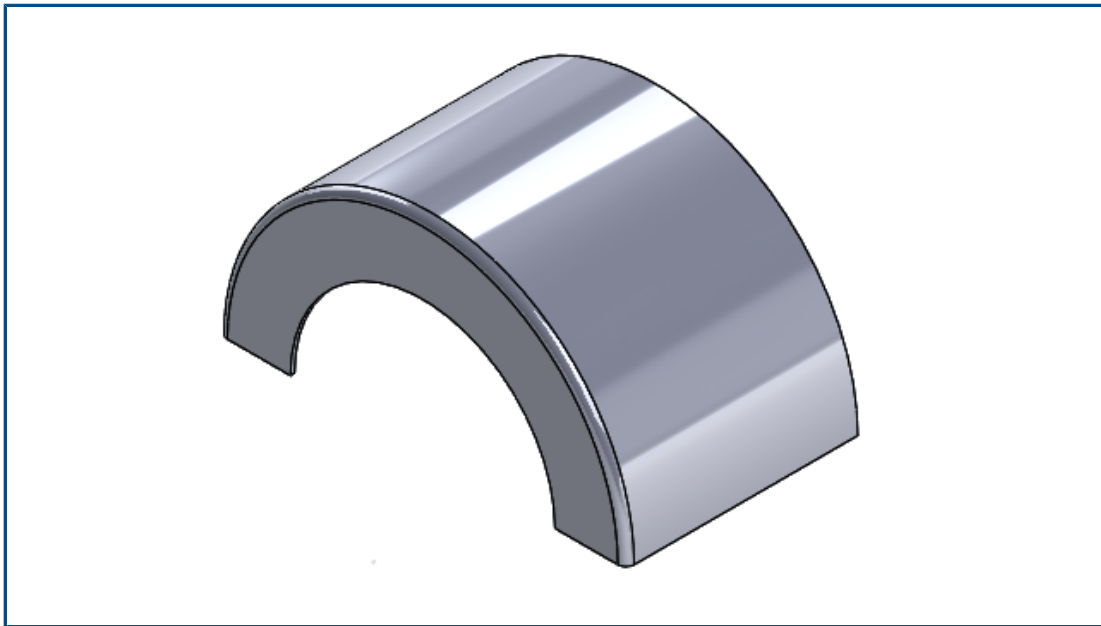

You can create edge flanges on nonlinear (circular) edges of nonplanar faces.

Click **Edge Flange**  (Sheet Metal toolbar) or **Insert** > **Sheet Metal** > **Edge Flange**.  
See *SOLIDWORKS Online Help: Edge Flanges*.

## Performance Improvements in Sheet Metal

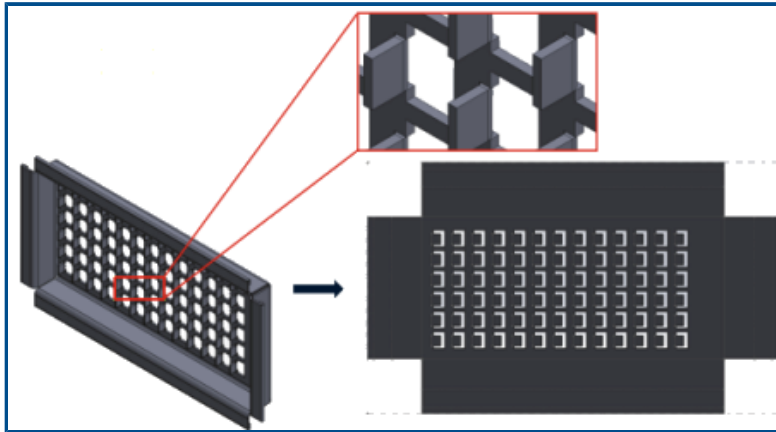

Flat patterns use efficient algorithms to identify bend connections. This reduces the time to flatten complex sheet metal bodies with many flanges by about 20-25 times.



# 9

## Structure System and Weldments

---

This chapter includes the following topics:

- **Graphical Manipulator in Structure System**
- **Correct Cut List Length of Weldment Member**
- **Trims for End Miter Joints**
- **Generating Cut List IDs**

### Graphical Manipulator in Structure System

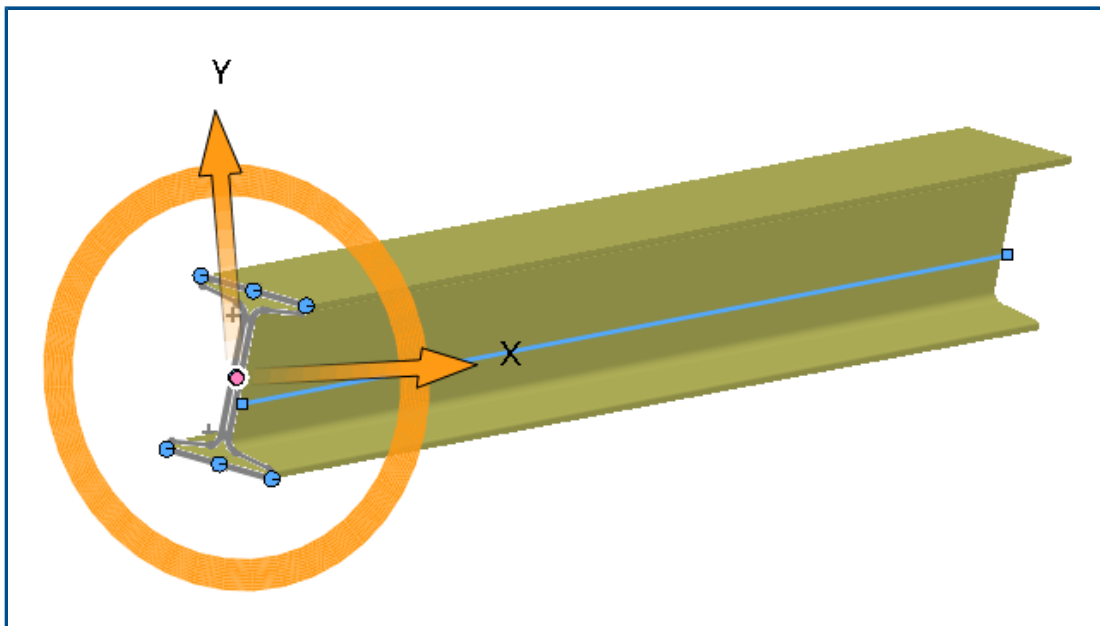

You can interact graphically on screen with the profile of the structural member. When you select the profile, the graphical manipulator appears in the graphics area at the pierce points. You can drag the profile horizontally or vertically, or rotate it to suit your alignment. When you drag the profiles, they automatically update in the Profile PropertyManager.

## Correct Cut List Length of Weldment Member

Property Name	Type	Value / Text Expression	Evaluated Value
LENGTH	Text	"LENGTH@@@PIPE, SCH 40, .50 DIA.<9>@Multiple	20.49
ANGLE1	Text	"ANGLE1@@@PIP	

The screenshot shows a 3D model of a weldment member with two curved ends and a straight central section. The 'Measure' dialog box is open, displaying a list of geometric entities: Arc1@Sketch1, Arc2@Sketch1, Arc4@Sketch12, Arc6@Sketch12, and Line3@Sketch12. The 'Total Length: 20.49 in' is highlighted in a red box, matching the 'Evaluated Value' in the table above.

You can calculate the correct cut list length of a weldment member in the cut list properties.

You can calculate the correct length when you:

- Use a **Move Face** or **Move/Copy Body** feature and then extrude a cut or a hole
- Create the part that contains multiple sketches by selecting **Merge miter trimmed bodies**
- Create an extruded cut or hole that modifies multiple faces across groups

## Trims for End Miter Joints

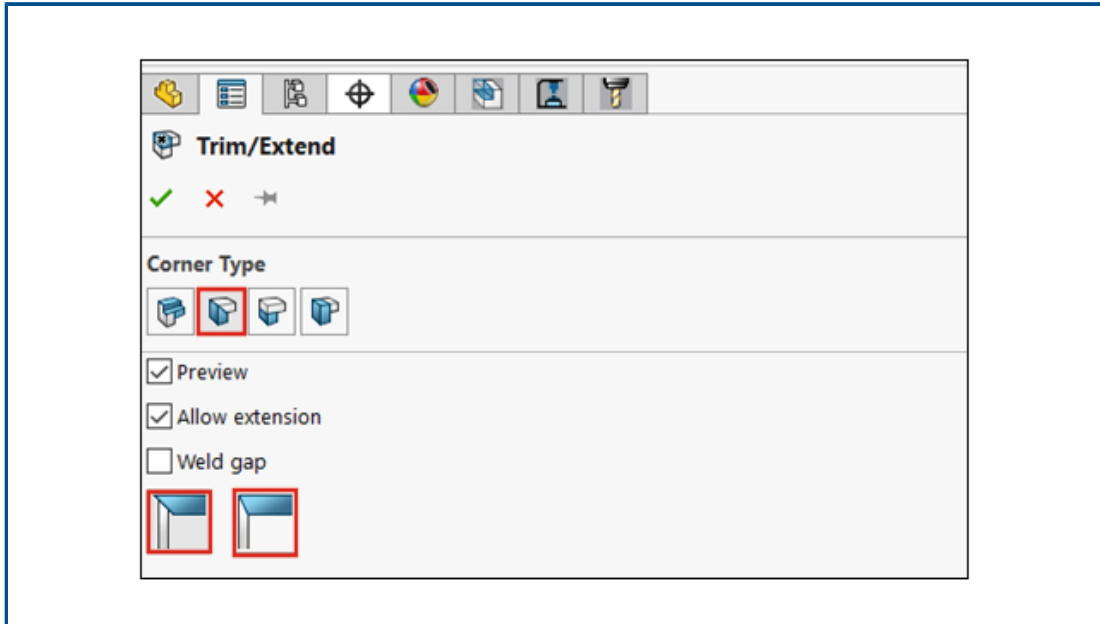

In the Trim/Extend PropertyManager, you can trim the end corner miters at an angle or make them flush.

Click **Trim/Extend** (Weldments toolbar) or **Insert > Weldments > Trim/Extend** and for **Corner Type**, select **End Miter** .

If the weldment profiles of the end segments are of different sizes, click **Angle Bisector** .



## Generating Cut List IDs

Cut list IDs

Generate Cut list IDs

Structure Cut list ID:  
%Description%, %MATERIAL%, %LENGTH%, %ANGLE1%, %ANGLE2%, %A

Sheet Metal Cut list ID:  
%Description%, %MATERIAL%, %Bounding Box Length%, %Bounding Box

Generic Cut list ID:  
%Description%, %MATERIAL%

You can generate cut list IDs or unique reference IDs for each cut list in a cut list folder based on the cut list attributes.

Click **Tools > Options > Document Properties > Weldments**. Under **Cut list IDs**, select **Generate Cut list IDs**.

Each generated cut list ID is added in the corresponding cut list folder. Unique cut list IDs result in unique naming convention of cut lists and are also used to index the database.

You can define different expression values based on the type of cut list.

# 10

## Assemblies

---

This chapter includes the following topics:

- **Saving a Defeatured Model as a Configuration**
- **Performance Evaluation Checks for Circular References**
- **Spacing Options for Chain Patterns**
- **Auto-Resolving Lightweight Components**
- **Exporting Interference Detection Results**
- **Slot Mates**
- **Synchronizing a Patterned Component to a Seed**
- **Mate Alignment**
- **Assemblies Performance Improvements**
- **Mate PropertyManager**

	<p><b>Video: What's New in SOLIDWORKS 2021 - Assembly Productivity Tools</b></p>
---	--

## Saving a Defeatured Model as a Configuration

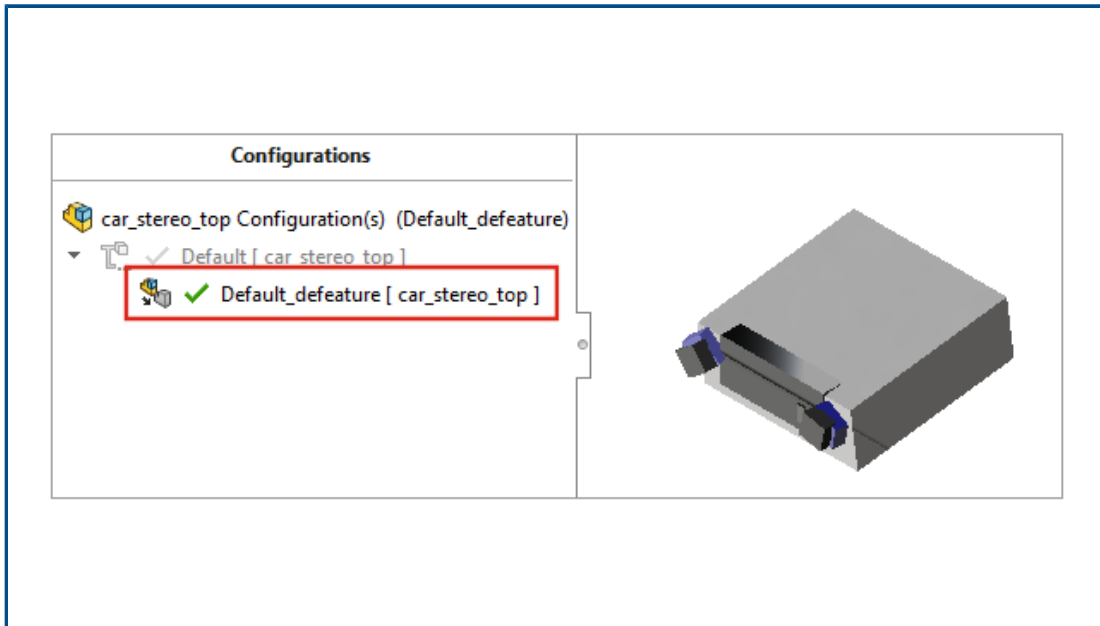

When you use the **Silhouette**  method for defeaturing, you can create a configuration from a defeatured assembly. In the assembly, you can switch between the defeatured configuration and the full model.

You can have only one defeature configuration under a parent configuration.

To save a defeatured assembly to a configuration, on the Defeature - Defeature Complete page, click **Create a new configuration** and select **Include top level reference geometry**.

## Performance Evaluation Checks for Circular References

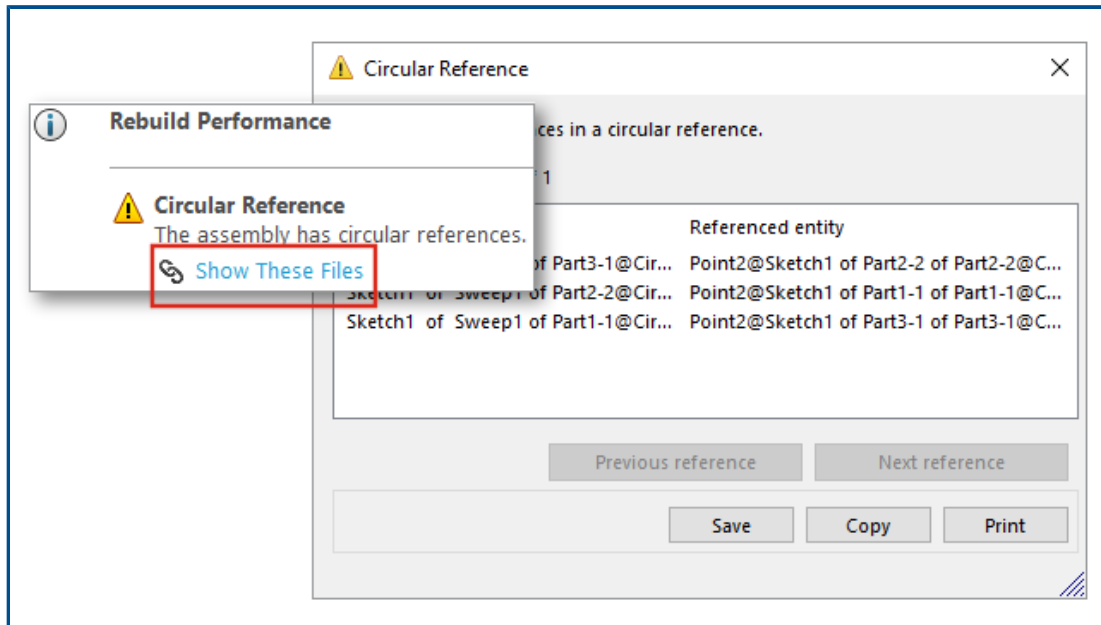

Performance Evaluation detects circular references in assemblies.

To check for circular references, click **Tools > Evaluate > Performance Evaluation**. Under **Rebuild Performance**, check the Circular References section for issues.

For information on the circular references, click **Show These Files** to open the Circular Reference dialog box.

## Spacing Options for Chain Patterns

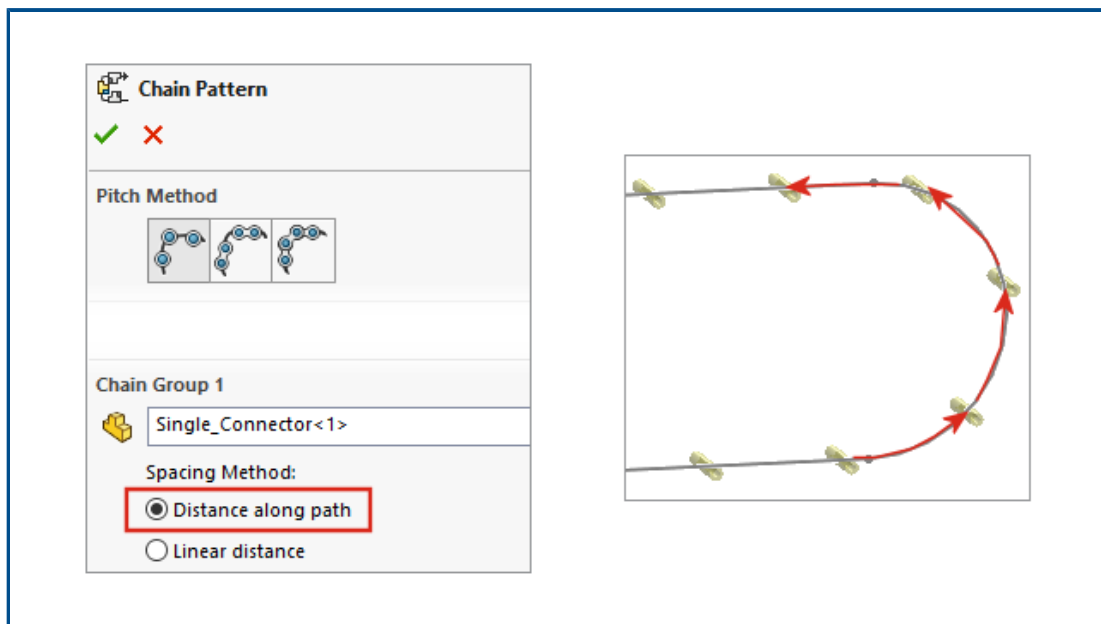

You can define spacing between chain pattern instances as a measure along a path for **Distance** and **Distance Linkage** chain patterns.

In the Chain Pattern PropertyManager, select a spacing method:

<b>Distance along path</b>	Spaces pattern instances at the specified distance as measured along a path.
<b>Linear distance</b>	Spaces pattern instances at the specified distance as measured as a linear distance.

## Auto-Resolving Lightweight Components

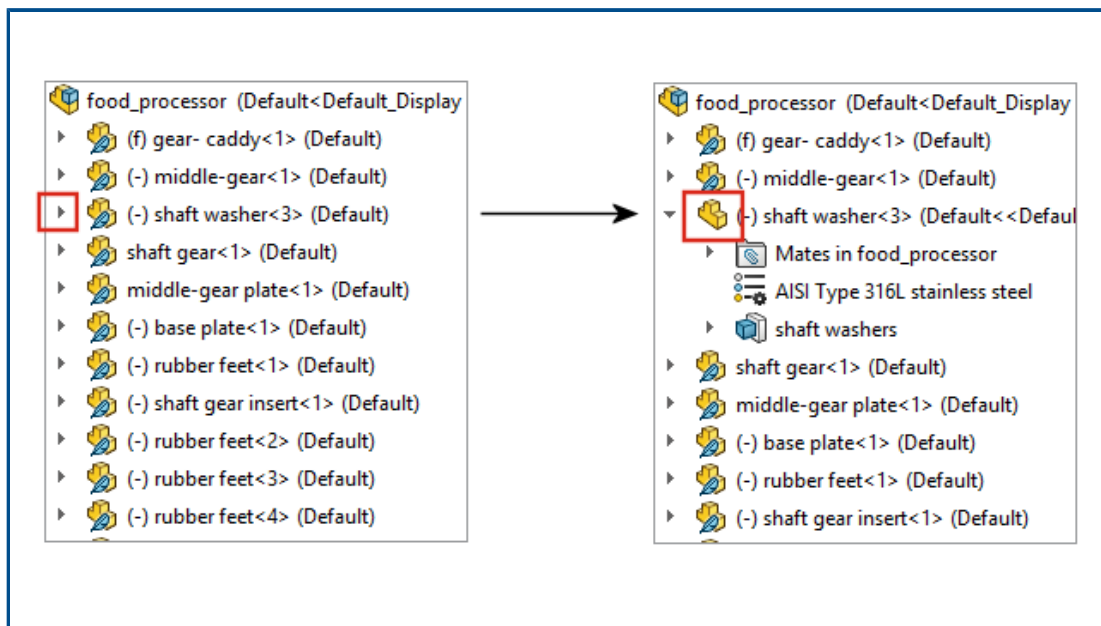



For assemblies opened in lightweight mode, top-level components and subassemblies resolve automatically when you click  to expand the item in the FeatureManager® design tree. Components in subassemblies remain in lightweight mode until you expand them.

## Exporting Interference Detection Results

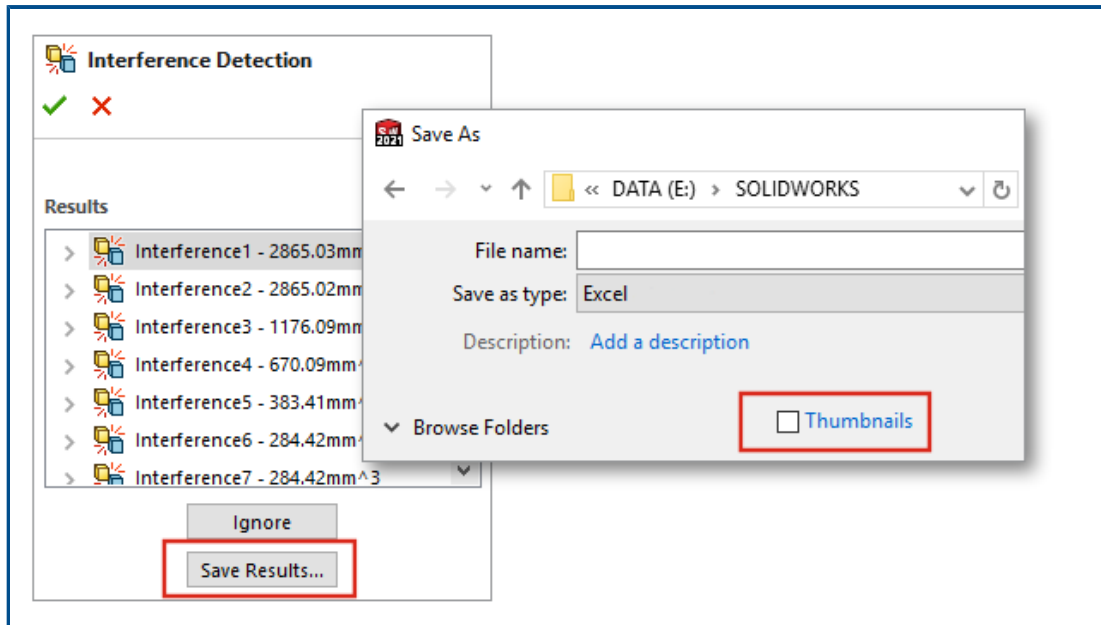

You can export results for interference detection in assemblies to a Microsoft® Excel® spreadsheet.

To export results:

1. Click **Tools > Evaluate > Interference Detection** and click **Calculate**.
2. Click **Save Results**.
3. Enter a file name and select **Thumbnails** to include an image of the interference.
4. Click **Save**.



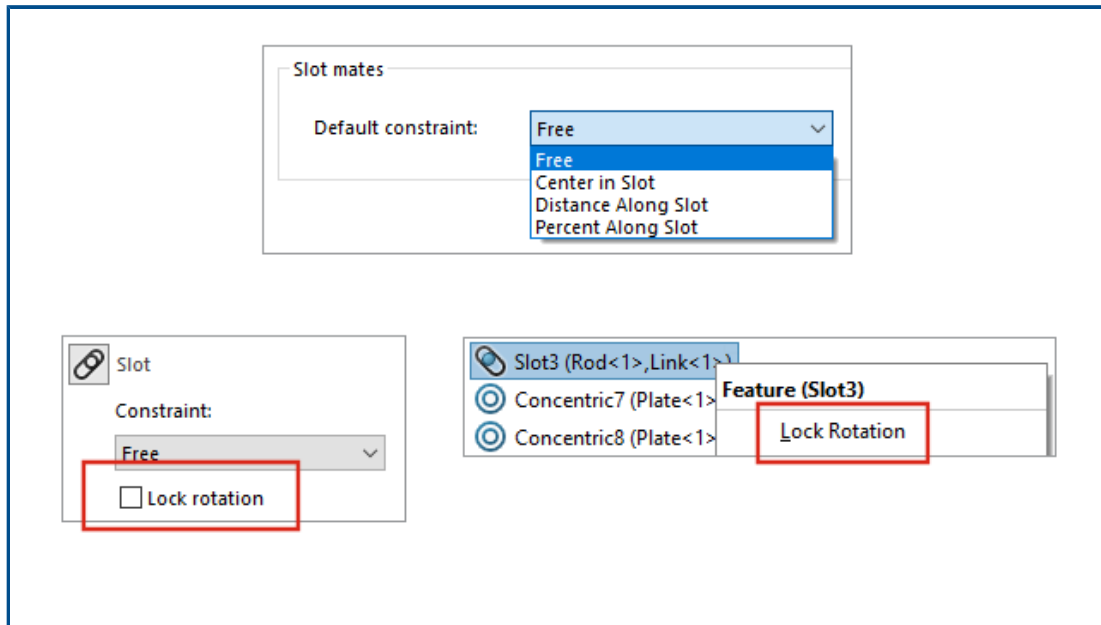

## Slot Mates



You can specify a default constraint type and lock the rotation for slot mates.

To select a default constraint type, click **Options** > **Document Properties** > **Mates** and under **Slot mates**, select an option for **Default constraint**.

To lock rotation for a slot mate:

- Under the **Mates**  folder, right-click the slot  mate and click **Lock Rotation**.
- Right-click the **Mates**  folder and click **Lock Rotation**.
- In the **Mates**  PropertyManager for slot mates, select **Lock Rotation**.

## Synchronizing a Patterned Component to a Seed

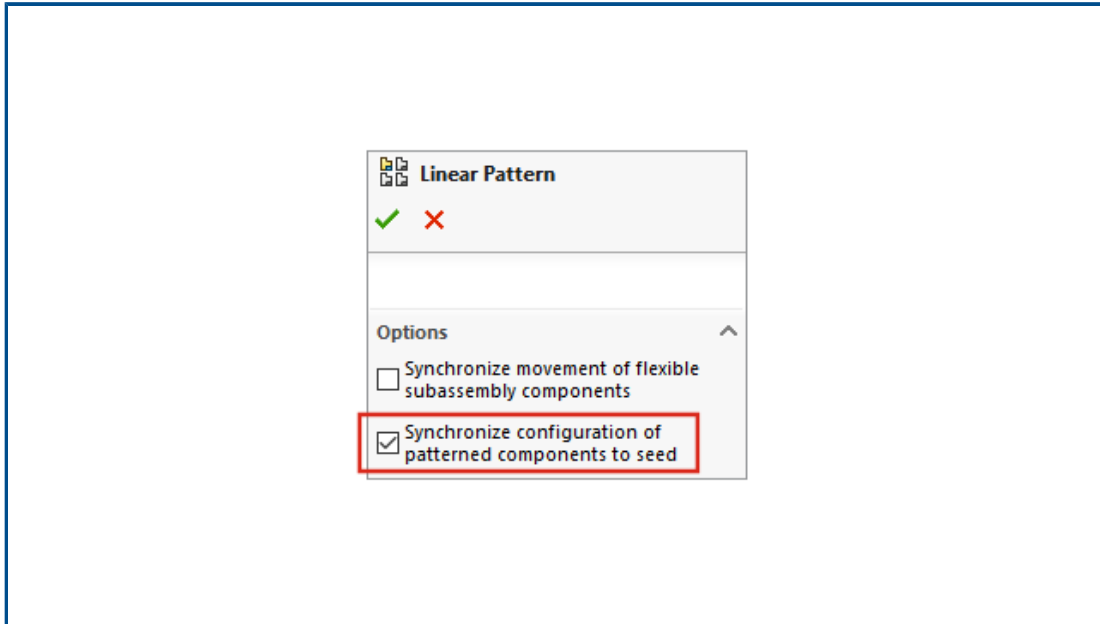

You can use **Synchronize configuration of patterned components to seed** to block changes to the configuration of patterned instances.

This option is available for component patterns and mirror components, and applies to all configurations.

## Mate Alignment

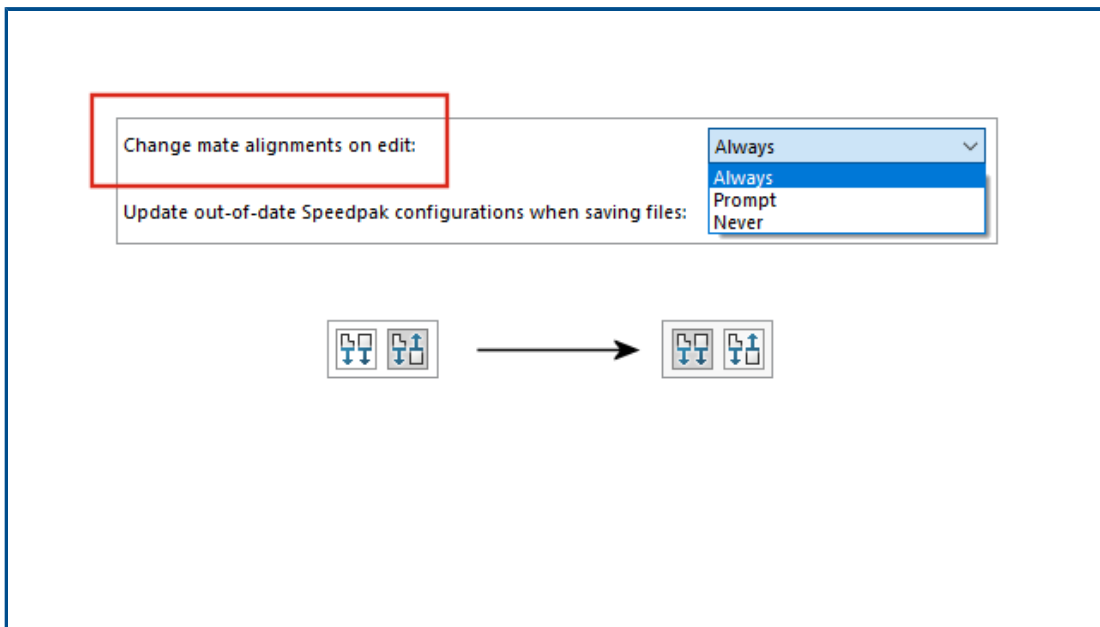

When you flip the alignment of a mate, the edited mate flips.

In Assemblies system options, select **Change mate alignments on edit** to warn you when mate changes result in errors that can be avoided by flipping the mate alignment. Specify **Always**, **Prompt**, or **Never** to determine when you receive the warning.

**Change mate alignments on edit** is renamed from **Prompt before changing mate alignments on edit**.

## Assemblies Performance Improvements



Assembly performance is improved when:

- Opening resolved and lightweight assemblies
- Opening assemblies with parts that have many configurations
- Updating assemblies that have many mates
- Closing assemblies without saving

## Mate PropertyManager

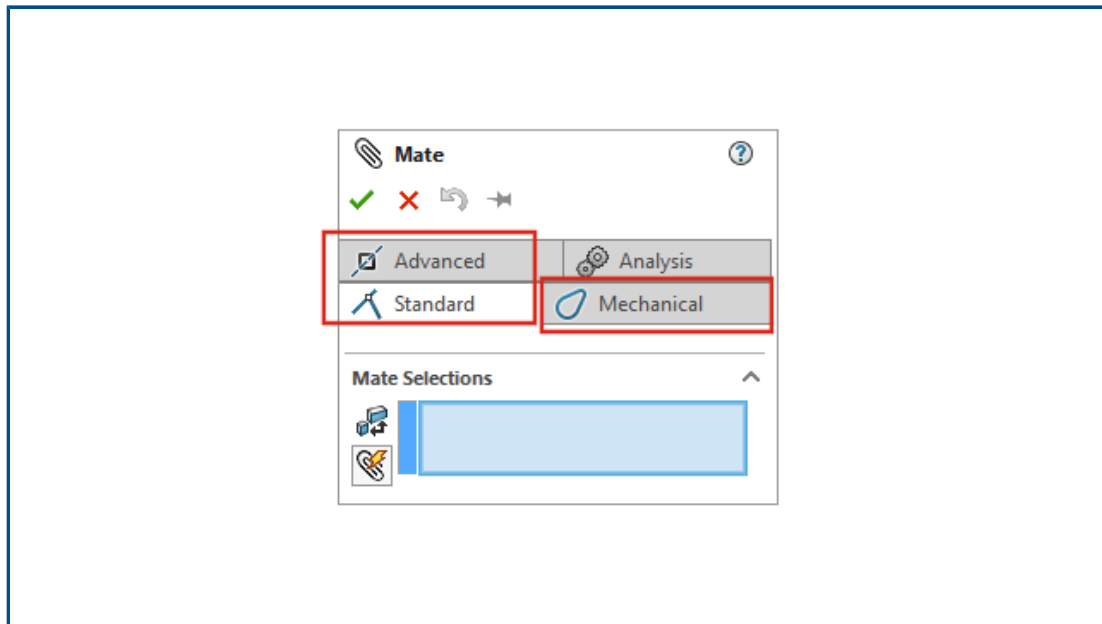

In the Mate PropertyManager, the standard, mechanical, and advanced mate types moved into separate tabs.

# 11

## Detailing and Drawings

---

This chapter includes the following topics:

- **Detailing Mode Enhancements**
- **Context Toolbars and Menus in Drawings**
- **Location of the Hatch Pattern File**
- **VDA Balloons**
- **Performance Improvements in Detailing and Drawings**

	<p><b>Video: What's New in SOLIDWORKS 2021 - Detailing Mode and Drawing Delighters</b></p>
--	--

### Detailing Mode Enhancements

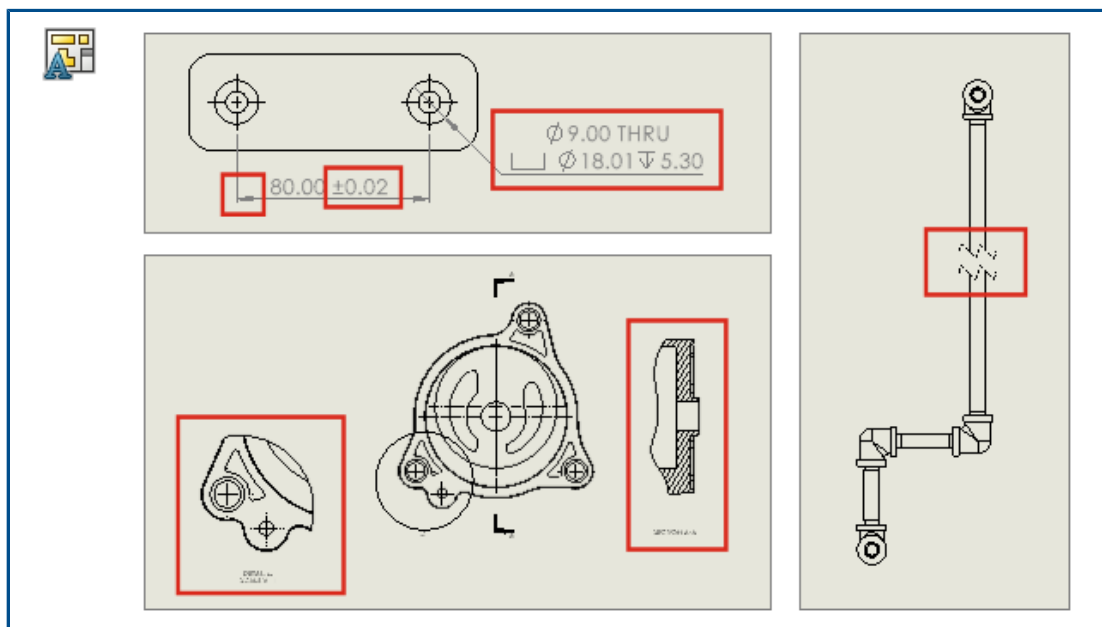

Dimensions and annotations created in Detailing Mode now update to reflect changes that you make to the model. In addition, you can create and modify break, crop, and

detail views, add and edit hole callouts, and edit additional characteristics of existing dimensions and annotations.

- **Robust Referencing in Detailing Mode**

Robust referencing saves you a dramatic amount of time by eliminating the need to resolve and save to maintain final annotation and dimension associativity. Previously, you had to fully resolve and save the drawing to avoid dangling dimensions and annotations.

- **Break, Crop, and Detail Views in Detailing Mode**

In Detailing Mode, you can create and modify break, crop, and detail views. You can also add dimensions and annotations to the views.

You must save the drawing in SOLIDWORKS 2021 before you can add or edit break, crop, or detail views to it in Detailing Mode.

- **Hole Callouts in Detailing Mode**

In Detailing Mode, you can add and edit hole callouts for holes that use Hole Wizard, Advanced Hole, Hole, Extruded Cut, Swept Cut, and Revolved Cut features.

- **Editing Existing Dimensions and Annotations in Detailing Mode**

In Detailing Mode, for existing dimensions and annotations created in resolved mode, you can edit additional characteristics. You can do the following:

- Edit dimension tolerance values
- Edit dimension characteristics such as line type and arrow type
- Add and remove dimensions in sets of chain and baseline dimensions
- Edit annotation note characteristics and content

## Context Toolbars and Menus in Drawings

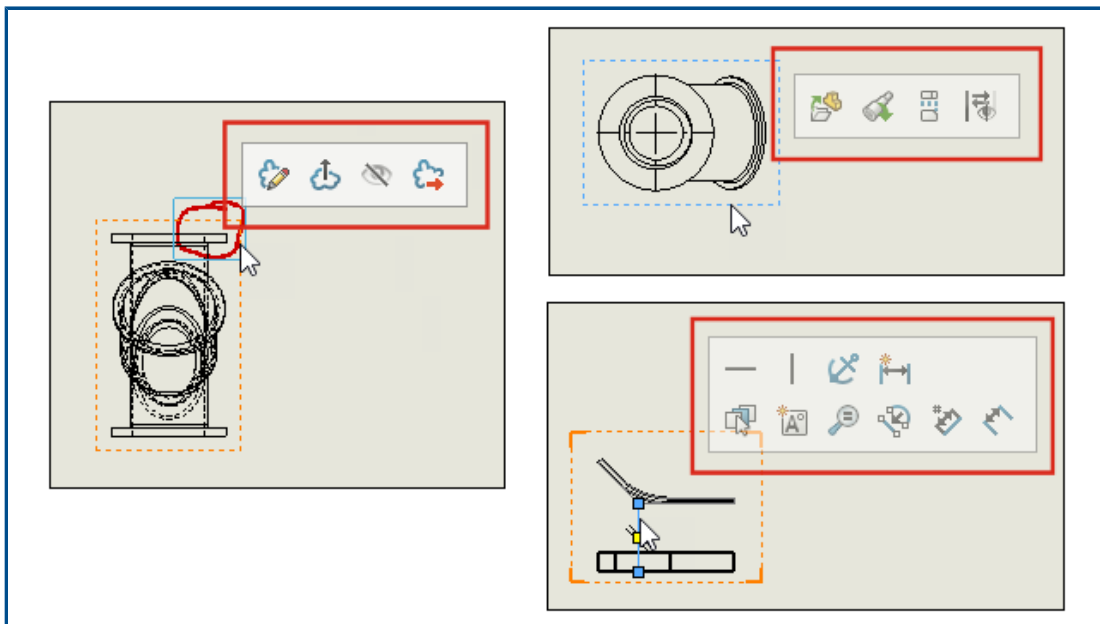

In drawings, you can access context toolbars and menus for centerlines, sketches, drawing views, and markups.

Click an item to display the context toolbar.

Right-click an item to display the context toolbar and menu.

## Location of the Hatch Pattern File

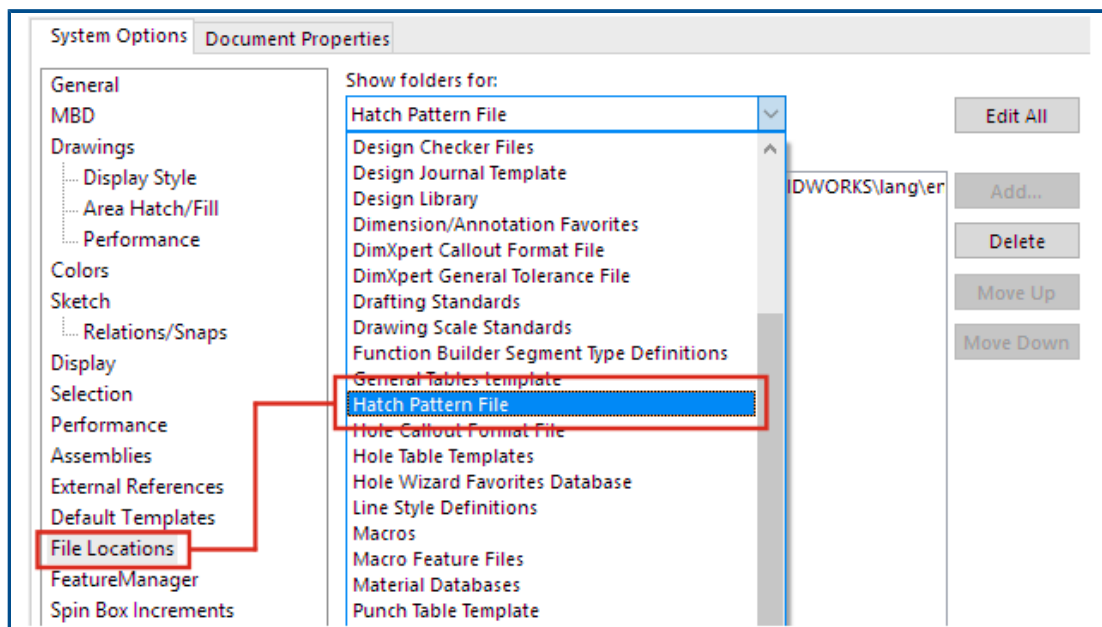

You can save the hatch pattern file, `sldwks.ptn`, in any searchable folder so it is not overwritten when you upgrade SOLIDWORKS®. This is useful if you customize the file.

By default, the hatch pattern file is saved in a SOLIDWORKS installation folder and is overwritten with the default file every time you upgrade SOLIDWORKS.

### To specify a new location for the hatch pattern file:

1. Move your modified `sldwks.ptn` file to the location of your choice.
2. Click **Options**  (Standard toolbar) or **Tools > Options**.
3. On the System Options tab, click **File Locations**.
4. In **Show folders for**, select **Hatch Pattern File**.
5. Select the current location of the hatch pattern file and click **Delete**.
6. To specify the new location, click **Add**, browse to the new location, and click **OK**.

If you share a drawing that uses a custom hatch pattern, also share the custom `sldwks.ptn` file for the recipient to use so that the pattern renders correctly.

## VDA Balloons

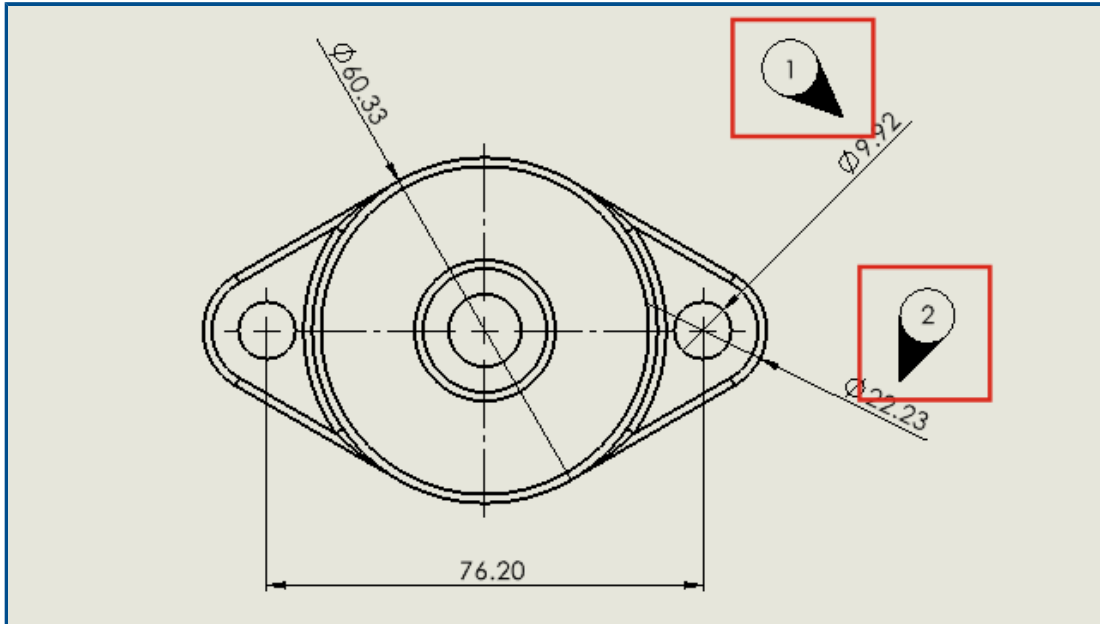

In drawings, you can tag inspection points according to VDA requirements. VDA balloons are frequently used in the German automotive industry.

You use circular balloons with a VDA leader type to create VDA balloons.

### Before you begin, specify options for the VDA leader:



1. Open the drawing.
2. Click **Options**  (Standard toolbar), select the **Document Properties** tab, and then select **Annotations**.
3. On the **Balloons** page, under **Leader display**, for **Single/Stacked Balloons**, select **VDA**.
4. On the **Notes** page, under **Leader display**, for **Single/Stacked Balloons**, select **VDA**.
5. Click **OK**.

### To add VDA balloons:

1. Click **Balloon**  (Annotation toolbar), or click **Insert** > **Annotations** > **Balloon**.
2. Under **Settings**, for **Balloon text**, select **Text**.
3. Click a location for the balloon.

A circular balloon appears.



4. In the PropertyManager, click **OK** .
5. Click the balloon, and then in the PropertyManager, click **More Properties**.
6. In the Note PropertyManager, under **Leader**, click **VDA Leader** .



The balloon changes to a VDA balloon.



You can move and rotate VDA balloons and edit the text. Select the balloon and do the following:

---

To move it, drag the attachment point. Optionally, you can attach the leader to an item such as an edge or vertex. Drag over the item and drop when the item highlights.



---

To rotate it, drag any part of it except the attachment point.



---

To change the text, select the balloon and edit **Balloon text** in the PropertyManager.



---

## Performance Improvements in Detailing and Drawings

	<p><b>Video: What's New in SOLIDWORKS 2021 - Drawing Performance</b></p>
---	--

Areas of improvement include Detailing Mode, massive drawings, section views, bills of materials (BOM), cosmetic threads, and opening and saving drawings.

In Detailing Mode, robust referencing saves you a dramatic amount of time by eliminating the need to resolve and save to maintain final annotation and dimension associativity.

For massive drawings, display performance is improved in many areas.

- While sketches are shown:
  - Zoom and pan performance is improved substantially.
  - For **Zoom to Area**, the shaded box keeps up with the pointer movement.

- Zoom and pan performance is more consistent regardless of zoom scale, for example, when zooming tight versus zooming to fit.
- The latency issue that occurred for the first pan is eliminated.
- Selecting and moving annotations is improved.
- Dynamic highlighting is improved.

Performance is also improved when:

- Creating and updating large section views
- Using **Auto Insert** to add center marks when creating section views
- Canceling **Edit Sketch** in broken-out section views
- Creating a detail view in a section view
- Importing a model's cosmetic threads into a view
- HLR background processing for high-quality display of cosmetic threads, by taking advantage of available CPU cores
- Sorting a BOM
- Opening a drawing file
- Selecting items in drawings
- Saving a drawing as a .dwg file

# 12

## SOLIDWORKS PDM

---

This chapter includes the following topics:

- **Customizing Columns**
- **Supporting Cut List References in Computed Bill of Materials**
- **SOLIDWORKS PDM File Explorer Enhancements**
- **Icon Changes for Workflow States and Transitions**
- **Treehouse View in the Where Used Tab**
- **SOLIDWORKS PDM Performance Improvements**
- **Displaying Derived Part References**
- **Using Bill of Materials Options Defined in SOLIDWORKS**

	<p><b>Video: What's New in SOLIDWORKS 2021 - SOLIDWORKS PDM</b></p>
--	---

SOLIDWORKS® PDM is offered in two versions. SOLIDWORKS PDM Standard is included with SOLIDWORKS Professional and SOLIDWORKS Premium, and is available as a separately purchased license for non-SOLIDWORKS users. It offers standard data management capabilities for a small number of users.

SOLIDWORKS PDM Professional is a full-featured data management solution for a small and large number of users, and is available as a separately purchased product.

## Customizing Columns

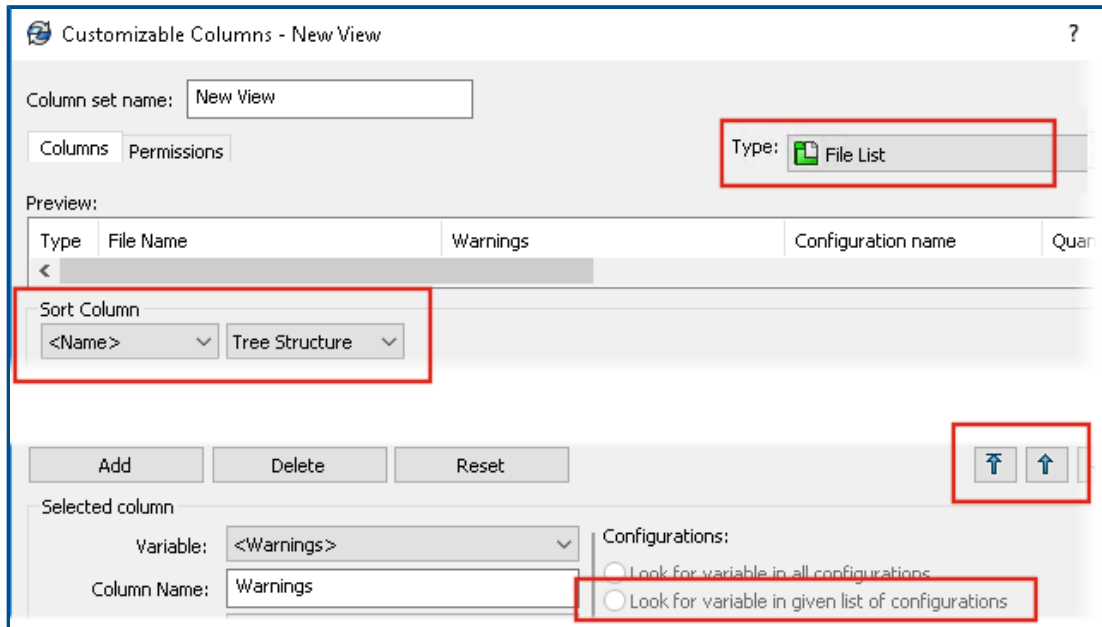

SOLIDWORKS PDM offers flexibility and control for column sets. You can assign multiple column sets to users or groups for all column set types. In SOLIDWORKS PDM File Explorer, you can view the file list based on assigned column sets.

- In the Administration tool, the **Columns** node contains column set types that list column sets.

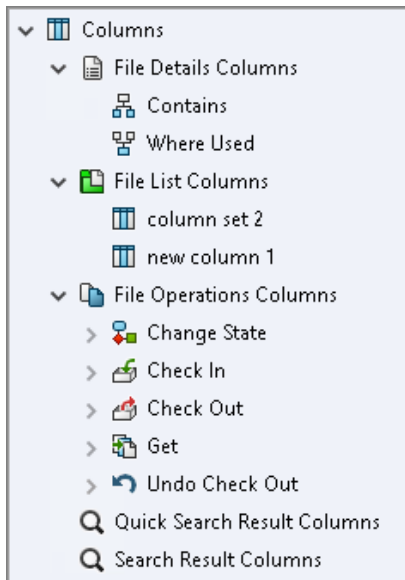

- The following table describes the column set types that you can define:

Type	Available In
File Details	<ul style="list-style-type: none"> <li>• Contains tab</li> <li>• Where used tab</li> </ul>
File Operations	<ul style="list-style-type: none"> <li>• Change state dialog box</li> <li>• Check in dialog box</li> <li>• Check out dialog box</li> <li>• Get dialog box</li> <li>• Undo check out dialog box</li> </ul>

For Search Result columns, you can assign multiple column sets through a search card.

- In the SOLIDWORKS PDM File Explorer, to view and switch between column sets, right-click any column header or empty space and select **Column Sets**. You can also change the order, adjust the width, and sort by column for each column set.

User customizations for column width and positions that were made on SOLIDWORKS PDM clients in a prior release are not available in the SOLIDWORKS PDM 2021 client.

- If you have the required administrative permissions, you can add and remove columns directly in the file details and file operations user interface. Right-click any column header, select **Column Sets**, and then select **My Columns** to specify it as the active column set. You can then use the **Columns** menu to add or remove columns.

This column set is specific to the user's login and the client machine.



You must have the following administrative permissions to access **My Columns**:

- **Can view and modify My Columns in File Details**
- **Can view and modify My Columns in File Operations**

## Configuring Column Sets

The Customizable Columns dialog box has new features that let you configure column sets.

### Columns Tab

Option	Description
 and 	The move to top and move to bottom controls let you arrange the columns.
<b>Sort Column</b>	Defines a default sort column and sort direction for each column set.

Option	Description
<b>Reset</b>	Restores columns to the default for the column set type.
<b>Look for variable in given list of configurations</b>	Lets you enter a configuration name and add it to the list of configurations. <div style="border: 1px solid gray; padding: 5px; margin-top: 5px;">Available only for <b>File List</b> column sets.</div>

## Permissions Tab

Option	Description
<b>View</b>	Assigns a column set to a user or group.
<b>Preferred</b>	Assigns a column set as the preferred one for users or groups.

You can also assign user and group permissions for column sets through the user properties and group properties dialog boxes.

1. In the Properties dialog box, click **Columns**.
2. In the Columns page, select **Type**.  
A list of available column sets appears.
3. Select **View** to assign permission and select **Preferred** if you want to specify it as the preferred column set.

## Supporting Cut List References in Computed Bill of Materials

Bill of Materials - BOM

Bill of materials name: BOM Type: Bill of Materials

Include derived part references

Include cut list references

Weldment Cut list

Weldment BOM

Preview:

File Name	Configuration	Part Number	Qty	State	Description
-----------	---------------	-------------	-----	-------	-------------

You can configure a computed BOM to include cut list references and then export it to an XML file.

In the Administration tool, in the Bill of Materials dialog box, select **Include cut list references**. You can base the cut list references on the **Weldment cut list** or the **Weldment BOM**.

If a cut list item is defined as **Exclude from cut list** in SOLIDWORKS, it is not displayed in the computed BOM.

## SOLIDWORKS PDM File Explorer Enhancements

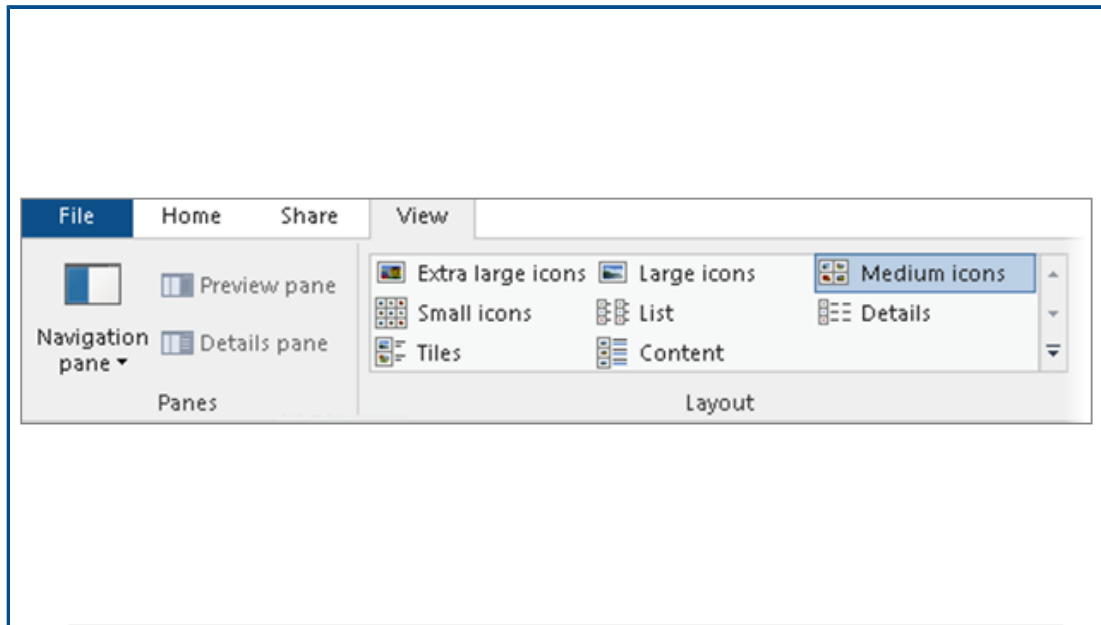

The ribbon control of Microsoft® Windows® File Explorer is also available in SOLIDWORKS PDM File Explorer.

Currently, in SOLIDWORKS PDM File Explorer, only View commands and few other commands of the ribbon control are supported.

- In SOLIDWORKS PDM File Explorer, you can use the **Quick Access Toolbar** to easily access commonly used commands. In the Administration tool, right-click a user or group and click **Settings**. In the left pane of the Settings dialog box, click **Quick Access Toolbar** and specify the commands.
- The file list and the search result lists support all Windows File Explorer view types except for Content.
- Workflow state icons beside the state name in the file list view make it easier to identify the state of the file.
- Click  to change the **Language** and view the **About** information of the installed SOLIDWORKS PDM product.
- Use **Back** and **Forward** from the address bar and return to the previously selected file.
- Use keyboard shortcuts for commonly used commands:

Action	Keyboard Shortcut
Check In	<b>Ctrl + I</b>
Check Out	<b>Ctrl + O</b>
Undo Check Out	<b>Ctrl + U</b>



Action	Keyboard Shortcut
--------	-------------------

Change State	<b>Ctrl + T</b>
--------------	-----------------

## Icon Changes for Workflow States and Transitions

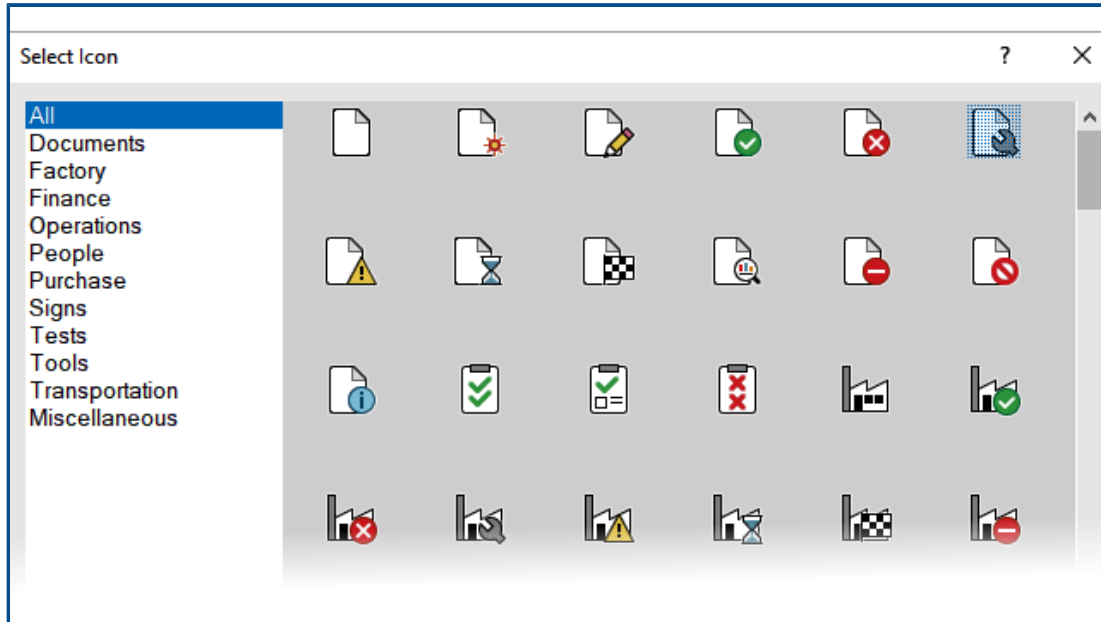

SOLIDWORKS PDM has new icons for workflow states and transitions. The colors and appearance of existing icons are improved.

In the Administration tool, open a workflow, and in the Properties dialog box of a state, click **Change**. In the Select Icon dialog box, icons are grouped under categories that make the selection process easier.

## Treehouse View in the Where Used Tab

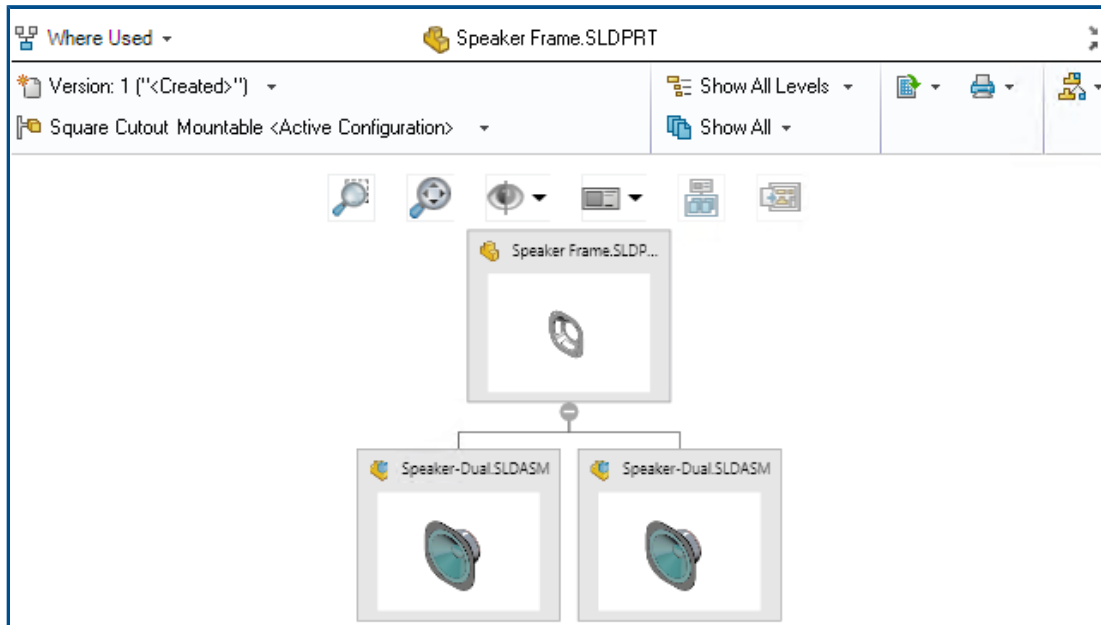

SOLIDWORKS PDM 2021 extends Treehouse view in the Contains tab to the Where Used tab. This helps you to view all the parent relationships of the selected child in a hierarchical and graphical format.

Available in SOLIDWORKS PDM Professional only.

## SOLIDWORKS PDM Performance Improvements

SOLIDWORKS PDM 2021 has improved performance of file-based operations and related workflows.

- **Add Files, Check-in, and Change State**

Improvements in system performance help you to quickly open, add, check in, and change the state of files with large reference structure. The Add Files operation is between 1.5 and 3 times faster. The Check-in and Change State operations are approximately 25% faster.

The level of improvement can vary depending on the number of files, network bandwidth, and CPU cores.

The Check-in dialog box itself displays much more quickly (in seconds rather than minutes) for very large assemblies or parts with a high number of configurations.

- **Destroy**

You can more quickly destroy files or folders. The operation is many times faster when you are destroying a large number of files.

- **Other Operations and Workflows**

Performance is significantly improved for the following operations:

- For folders containing a very large number of files:
  - Check-in and Check-out of a file
  - Adding a new file by dragging or by copying and pasting
  - Creating a new file from a template
- For assemblies with a large number of components at a single level, when working in SOLIDWORKS:
  - Opening files
  - Saving files
  - Switching windows
- Editing a target file name in the Copy Tree dialog box in a high latency environment
- Using Copy Tree when a user setting is added to clear variable values

## Displaying Derived Part References

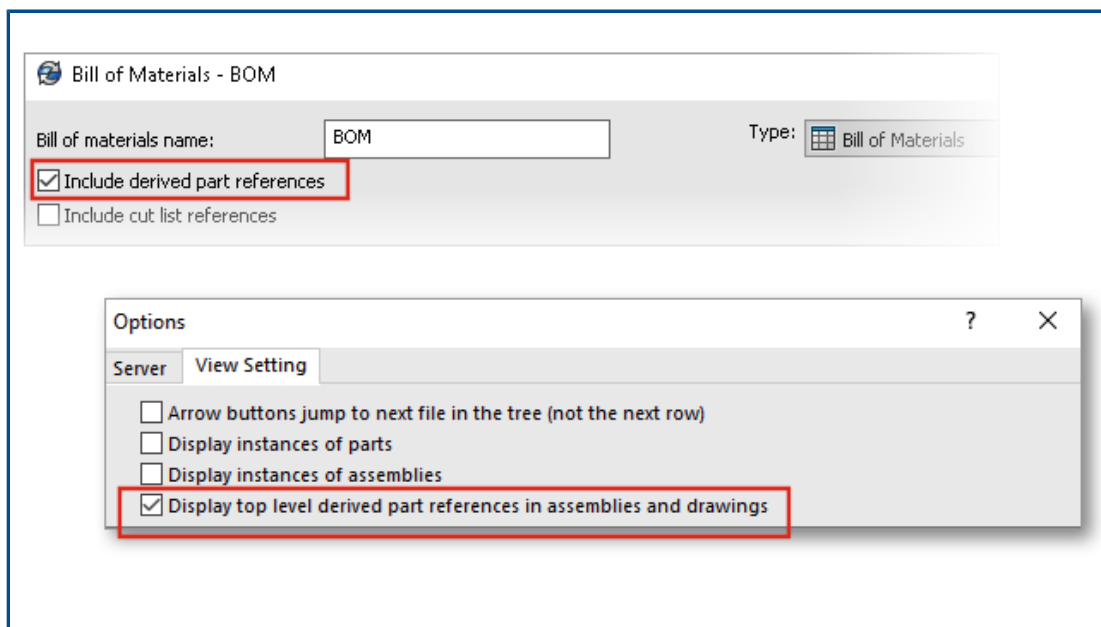

The support for the derived part references is improved and you can view them in the file view tabs and SOLIDWORKS PDM Add-in.

- Computed BOM
  - You can configure a computed BOM to include derived part references. In the Administration tool, open the Bill of Materials dialog box, and select **Include derived part references**.
- Contains and Where Used tabs
  - You can view derived part references in the Contains and Where Used tabs regardless of the selected configuration. Previously, derived part references were displayed only when you selected the **Do not show configurations** option for the configuration.

- SOLIDWORKS PDM Add-in

In SOLIDWORKS, click **Tools > SOLIDWORKS PDM > Options**. In the View Setting tab, select **Display top level derived part references in assemblies and drawings**. You can view the top-level derived part references in the reference structure for assemblies and drawings.

You can also view 3D Interconnect derived part references in the reference structure of the parent part file.

## Using Bill of Materials Options Defined in SOLIDWORKS

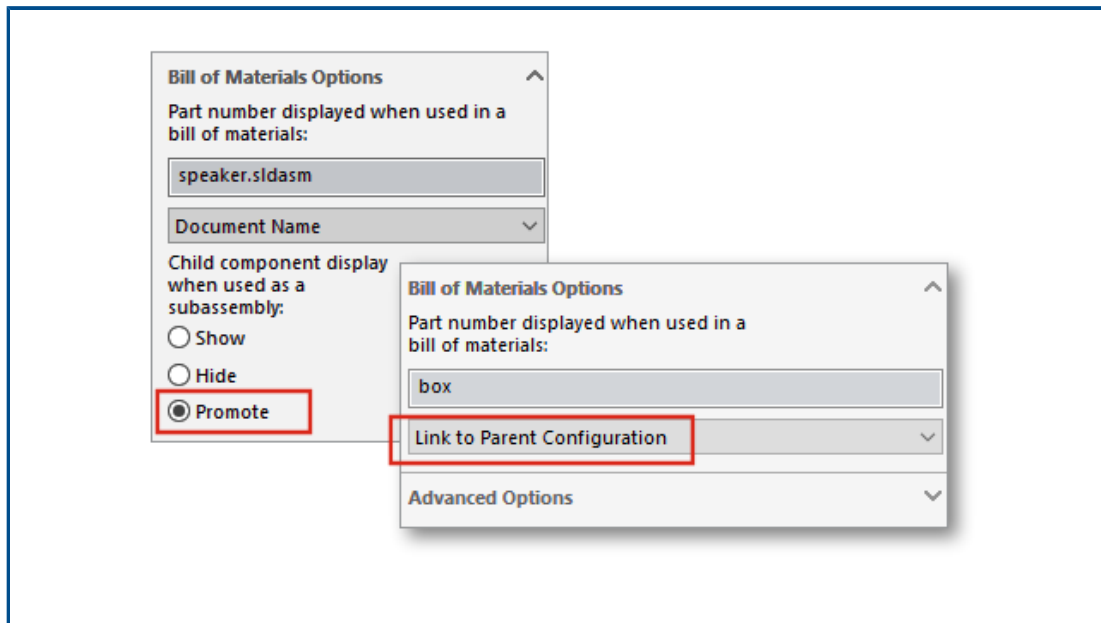

SOLIDWORKS PDM uses the Bill of Materials component display settings that are specified in SOLIDWORKS.

In SOLIDWORKS, in the Configuration Properties PropertyManager, the parameters that you specify in the Bill of Materials Options are also supported in computed BOMs of SOLIDWORKS PDM.

- In SOLIDWORKS, the **Promote** option for **Child component display when used as a subassembly** dissolves the subassemblies in the BOM and displays the child components. The computed BOMs follow this behavior for subassembly references that are defined to **Promote**.

This option applies only to computed BOMs. The assembly is included as a reference in the Contains and Where Used tabs.

- In SOLIDWORKS, the **Link to Parent Configuration** option for **Part number displayed when used in a bill of materials** sets the configuration to use the same part number as the parent configuration. If you define this option, the computed BOM uses the part number of the parent configuration.

This option is available only for derived configurations.

# 13

## SOLIDWORKS Manage

---

This chapter includes the following topics:

- **Bill of Materials Enhancements**
- **Task Enhancements**
- **SOLIDWORKS Manage User Interface Enhancements**
- **Database Debug Log Viewer**
- **Promotion Settings for SOLIDWORKS PDM Reference Files**
- **Multiselect Project Stages and Show Substages Options**
- **Access to the Capacity Planning Dashboard**
- **SOLIDWORKS File Preview in the Plenary Web Client**
- **Thumbnail Utility for SOLIDWORKS PDM Objects**
- **Access to Numbering Schemes**
- **Partial Administrators for Dashboards**
- **Save as Recursive**
- **Viewer Licenses**
- **Multi-Language Display Names**
- **Controlling Field Values**
- **Optionally Upgrading the Database**
- **File Sharing Option**
- **Other SOLIDWORKS Manage Enhancements**

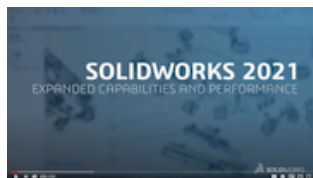

**Video: What's New in SOLIDWORKS 2021 - Manage**

SOLIDWORKS® Manage is an advanced data management system that extends the global file management and application integrations enabled by SOLIDWORKS PDM Professional.

SOLIDWORKS Manage is the key element in providing Distributed Data Management.

## Bill of Materials Enhancements

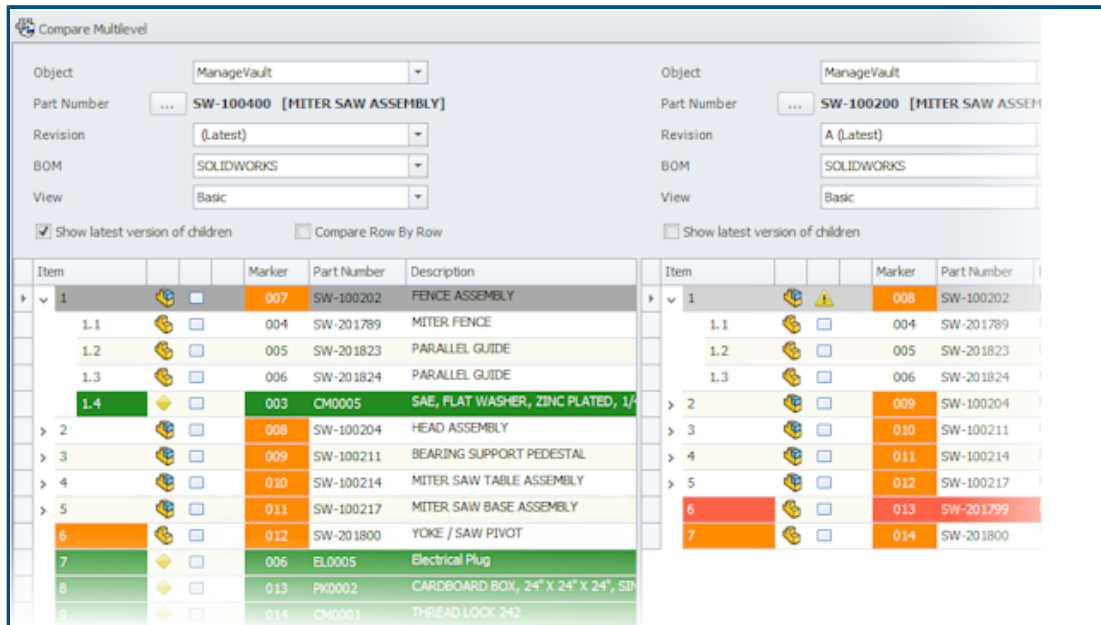

SOLIDWORKS Manage offers more capabilities for managing and exporting Bills of Material.

- You can check out and edit the Bill of Materials (BOM) values of a parent file without checking out its child files or items.

Available only for limited field types.

- You can export a BOM in tree format with **Export BOM items in Tree Style**. The BOM export settings of the selected object are applicable for all files and items of the BOM.
- You can compare all the levels of BOMs by specifying the **Multi-line compare** option in the Bill of Materials (BOM) compare tool.
- You can create linked records directly from a BOM view even if the record is not checked out.

## Bill of Materials Editing Features

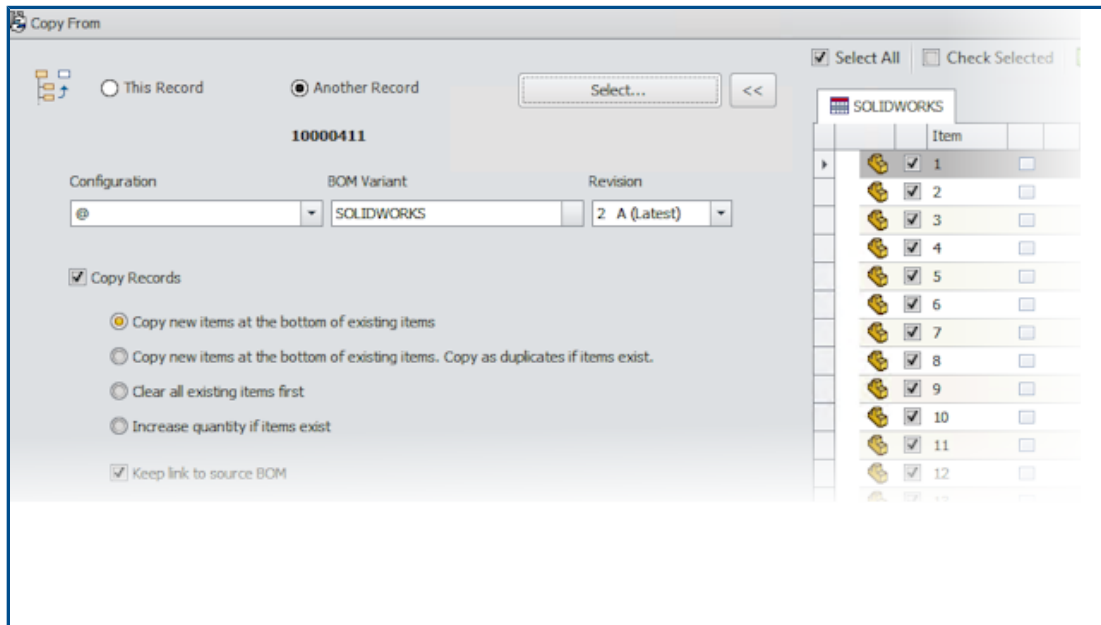

SOLIDWORKS Manage 2021 has Bill of Materials editing features that allow streamlined editing and rearranging of line items.

These new features are available in the **Bill of Materials** toolbar:

Option	Description
<b>Dissolve</b>	Click <b>Dissolve</b> and use the Dissolve dialog box to remove parent sub-structures and promote their child items into the current level that is under an editing state.
<b>Add New</b>	Click <b>Add New</b> and use the Add New dialog box to add a new item to a BOM. If you have permission, you can select records from multiple objects.
<b>Add New From</b>	Click <b>Add New From</b> and use the Add New From dialog box to add a new item using the selected item as the source record. This is similar to the New From function available in other areas.
<b>Cut, Copy, and Paste</b>	Use the <b>Cut</b> , <b>Copy</b> , and <b>Paste</b> commands to copy or move items across levels.
<b>Replace</b>	Use <b>Replace</b> to directly replace a selected item with a newly created record.
<b>Copy From</b>	Click <b>Copy From</b> and use the Copy From dialog box to view the structure of the selected record and also select the items that you want to copy.

## Task Enhancements

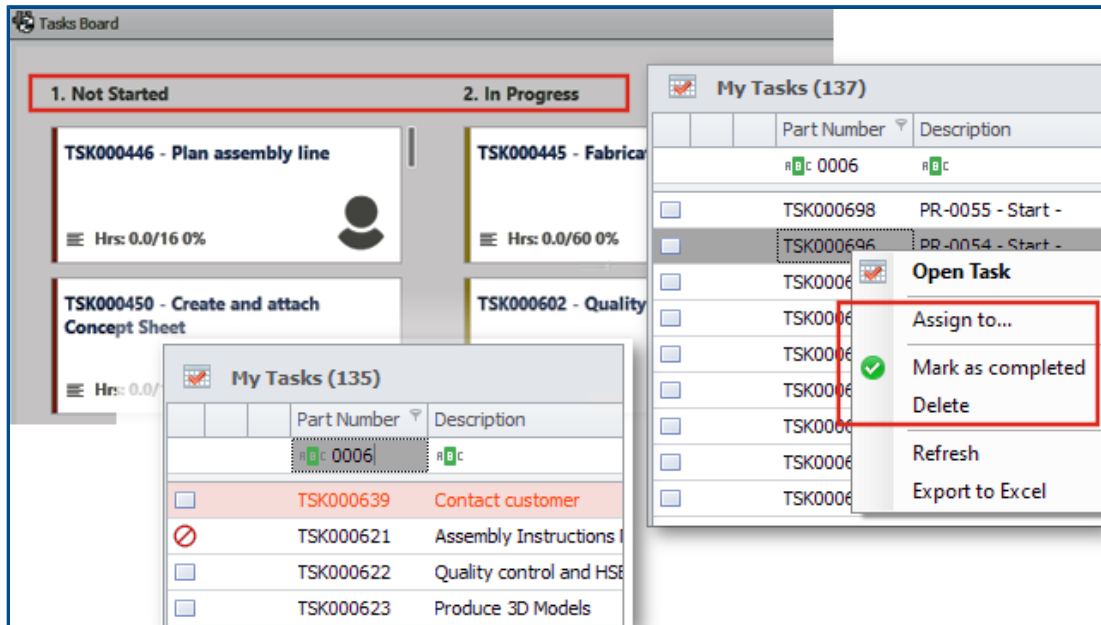

SOLIDWORKS Manage lets you control and manage tasks efficiently.

- Task Board is now accessible from the Capacity Planning dashboard and My Work area. You can group tasks based on priority or status. You can also order them by subject, start date, due date, created date, or progress.
- The following new context menu items are available for the Tasks in the My Work area:
  - **Assign To**
  - **Mark as complete**
  - **Delete**
- In the Default Dashboard - Tasks, the following enhancements are done:
  - **Part number** and **Priority** columns are available.
  - Urgent tasks are highlighted.
  - The order of tasks is the same as in My Tasks.
  - The user interface retains the order, filter, and item selection even after a refresh.
- The owners can control the tasks that an assignee can do. In the Task Templates form, under **Allow assigned users to**, select the following:
  - **Add attachments**
  - **Remove attachments**
  - **Change details list**
- The following options are selected by default to make the newly created tasks private:
  - **Create new tasks as "private"** in the My Options dialog box
  - **Private** option in the **Stage Task** dialog box

These tasks are visible only to the owner and the assignee.



- When you select **Email task owner when task is completed** in the System Administration tool, the owner of the tasks automatically gets notified on the task completion. The email is sent to the owners for the tasks that are created after you select the option.
- Tasks can have a main attachment such as a project or process that can be edited or deleted.

## SOLIDWORKS Manage User Interface Enhancements

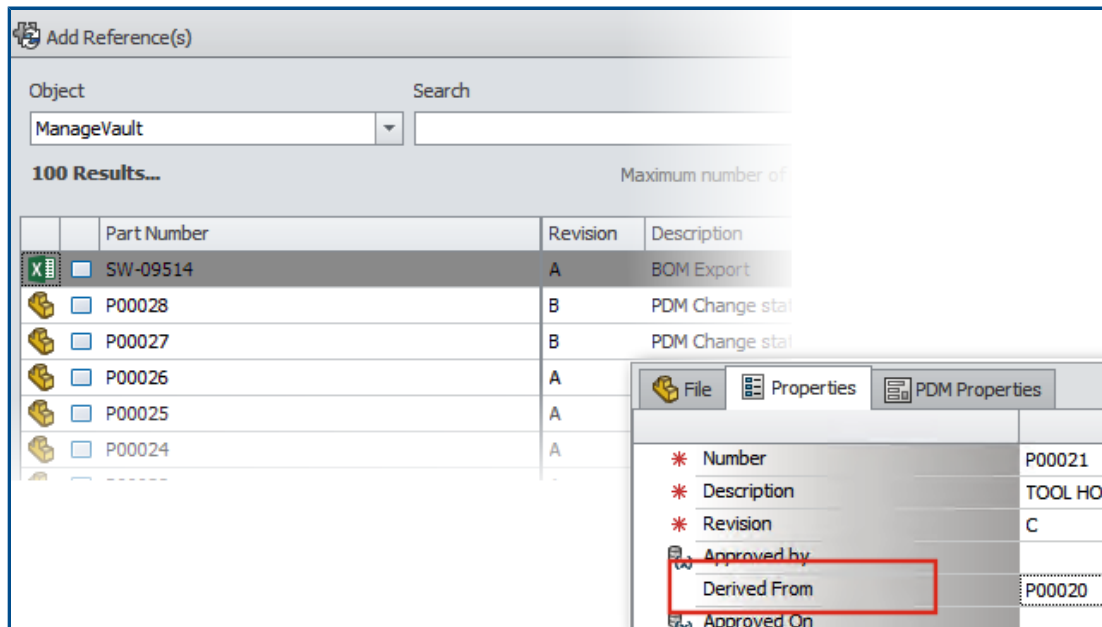

The SOLIDWORKS Manage user interface has many improvements that improve usability, including new options and controls, and new locations for existing controls.

- When you add records to a Reference folder with a single object enabled, the specified object is automatically selected from the list.
- When you create a new record using **New From**, the **Derived From** system field appears and automatically displays the source record's part number.
- The Project stage properties page has a link to update third-party fields.
- The Objects and Fields form, added in 2020 Service Pack 1, has icons for objects and fields.
- The **move** command is also available in the main project grid. Previously, it was available only in the project property card.
- The Capacity planning user selection form has all the custom fields for users. Previously, only system fields were available.
- The **Change owner** option in Tasks displays all user fields instead of a simplified list.
- The Data Sources dialog box is available in the field definition for Data Source type fields. To access this, in the Field Properties dialog box, in the Properties tab, click the ellipsis to select from the **Data Source** list.
- The default sort order for new objects is set to **Created Date** in descending order so the newest records are on top. You can also change the default sort order.
- In the Administration tool, you can display context-sensitive help from various dialog boxes.

- The Notification editor has buttons that let you insert dynamic field values. Previously, the dynamic content was only available through the context menu and was not discoverable.
- You can use a context menu to move records available as deliverables in a project stage.
- The Preview pane displays the selected files in the Where Used tab. You can visualize parent assembly structures without navigating to the parent record.
- When you write queries, you can get the ID information about the fields and objects from the Objects and Fields Information dialog box.
- The field control icons appear on the left side of the field entry box instead of the right side. This improves your view in full screen mode as you do not need to move the cursor away from the field label.

## Database Debug Log Viewer

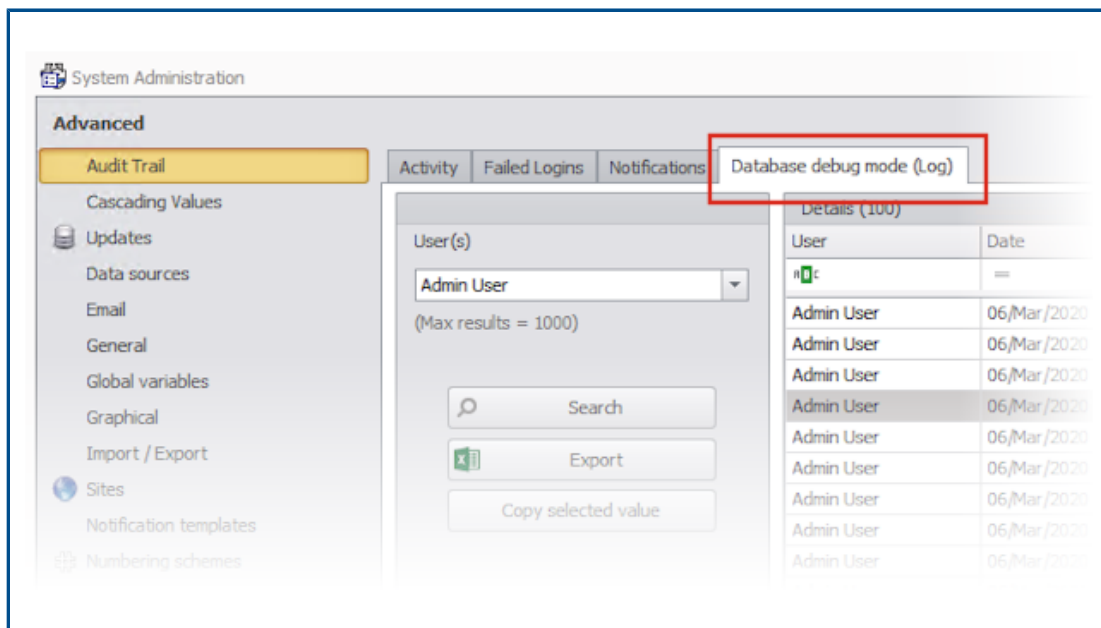

In the Administration tool, for **Audit Trail**, administrators can specify that tracked errors are written to a log file on the user's computer. The user can then send this log file to the administrators or to the SOLIDWORKS Technical Support team for analysis.

To enable database debug mode, in the My Option dialog box, specify **Database debug mode**.

## Promotion Settings for SOLIDWORKS PDM Reference Files

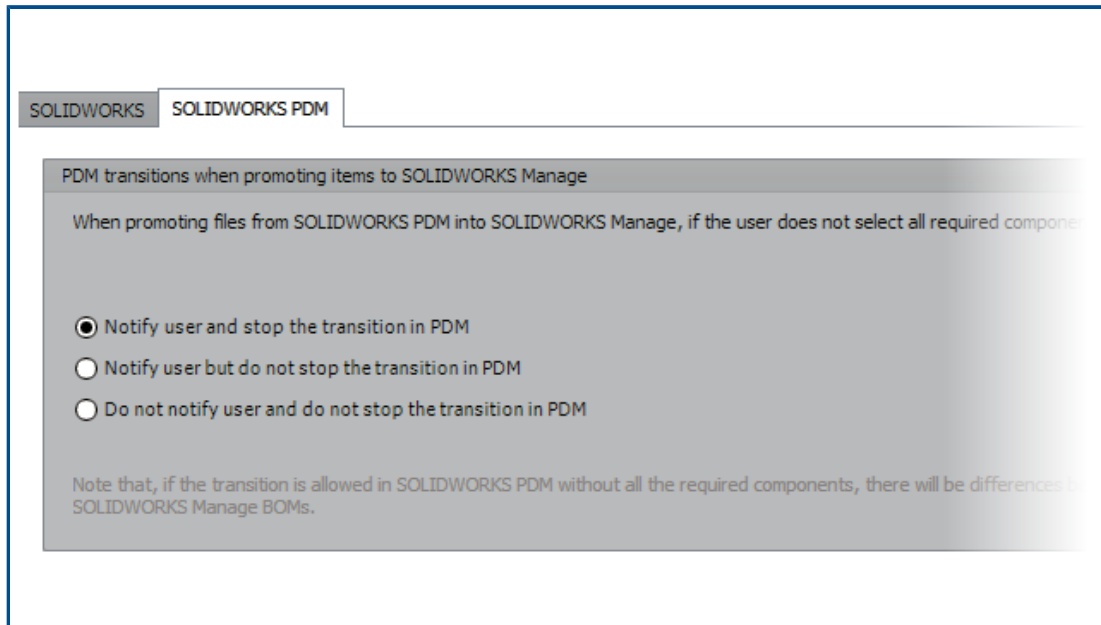

You can select the options that are available to define the handling of missing file references during promotion through SOLIDWORKS PDM state change.

The options are:

- **Notify user and stop the transition in SOLIDWORKS PDM.** This is the default behavior.
- **Notify user and continue the transition in SOLIDWORKS PDM**
- **Do not notify user and continue the transition in SOLIDWORKS PDM**

If you select this option, it may result in differences between SOLIDWORKS PDM and SOLIDWORKS Manage BOMs.

## Multiselect Project Stages and Show Substages Options

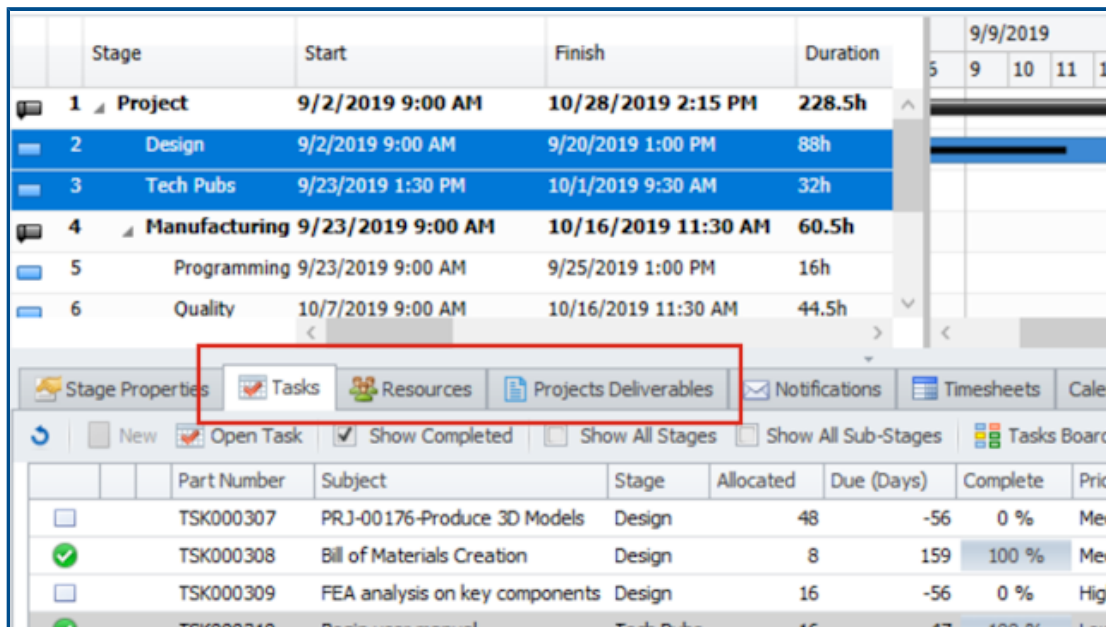

You can select multiple stages and view associated resources, tasks, and deliverables.

In the record Property Card, select **Show All Sub-Stages** to view the project tasks, resources, and deliverables connected to the substages of the selected stage.

## Access to the Capacity Planning Dashboard

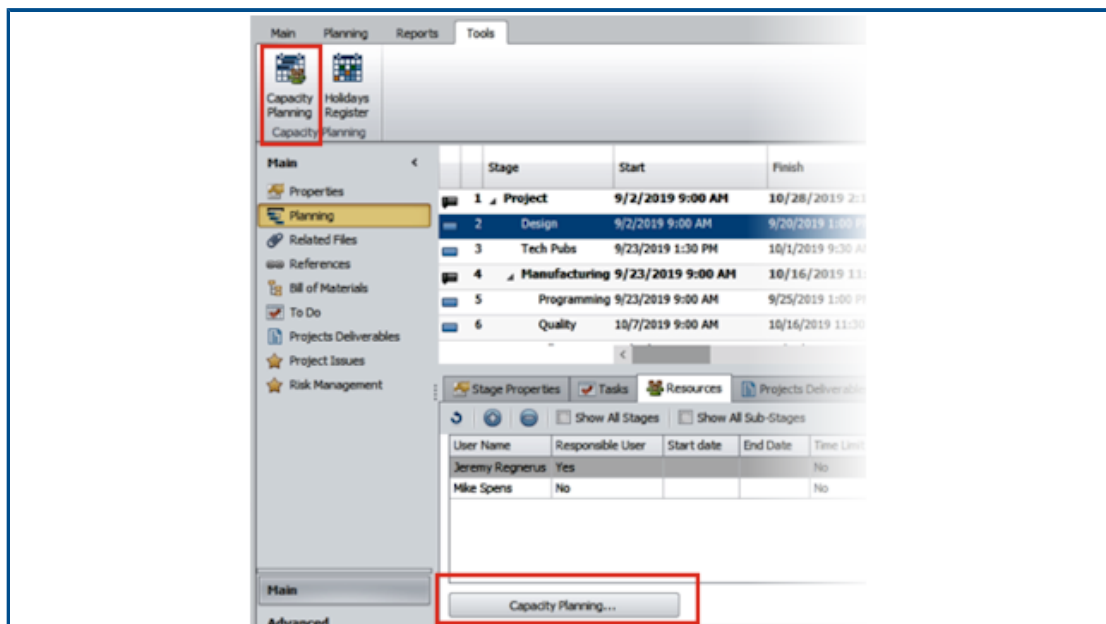

You can access the Capacity Planning dashboard from the **Tools** menu and the Resources tab of a project property card.

The users that you select in the Resources tab appear in the Capacity Planning dashboard.

## SOLIDWORKS File Preview in the Plenary Web Client

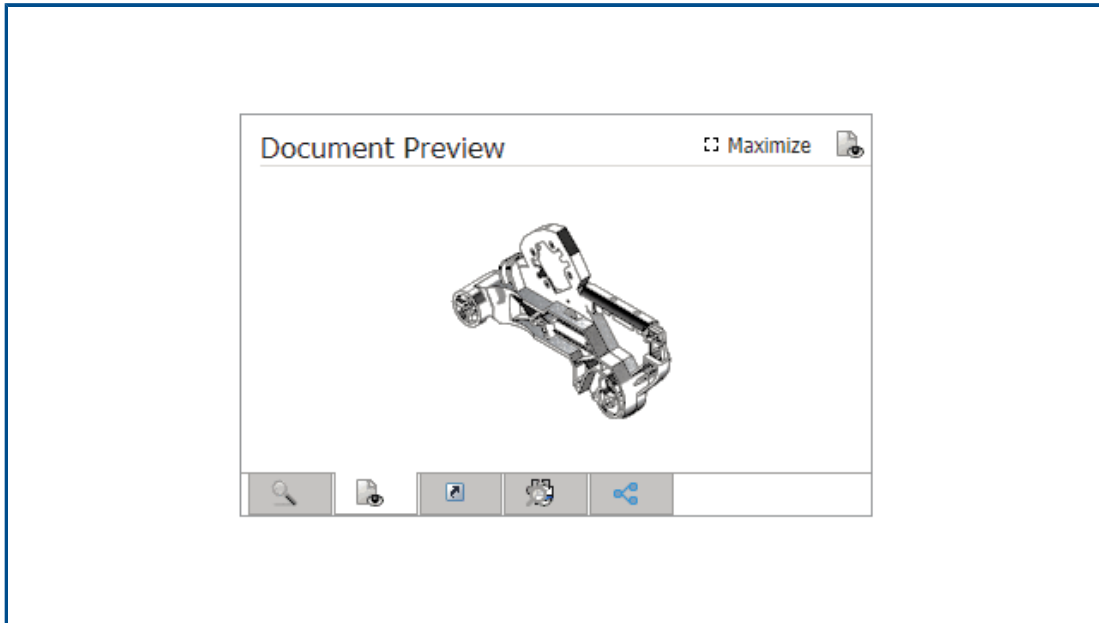

You can view thumbnail images for SOLIDWORKS files in the Preview pane. You can also maximize the image.

For files stored in a SOLIDWORKS PDM vault object, click the link and open the file in the SOLIDWORKS PDM Web2 browser for dynamic viewing.

## Thumbnail Utility for SOLIDWORKS PDM Objects

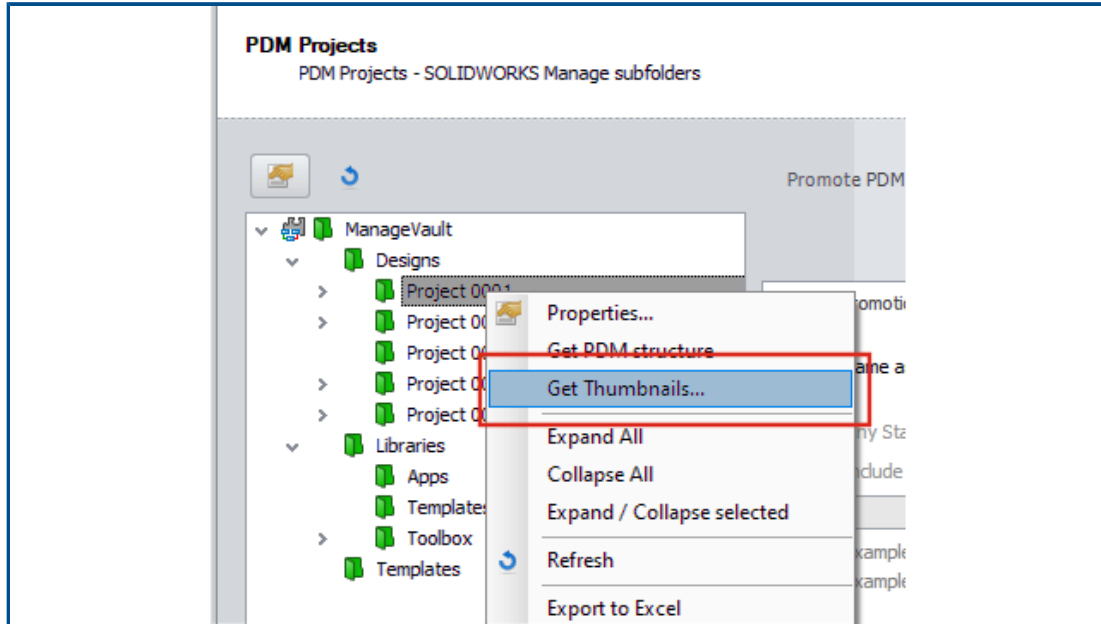

A new utility is available in the SOLIDWORKS PDM object administration wizard.

This utility gets the thumbnail images for SOLIDWORKS parts, assemblies, and drawings from the SOLIDWORKS PDM archive server. It also helps to attach a new SOLIDWORKS PDM vault where the files do not have images stored in SOLIDWORKS Manage.

## Access to Numbering Schemes

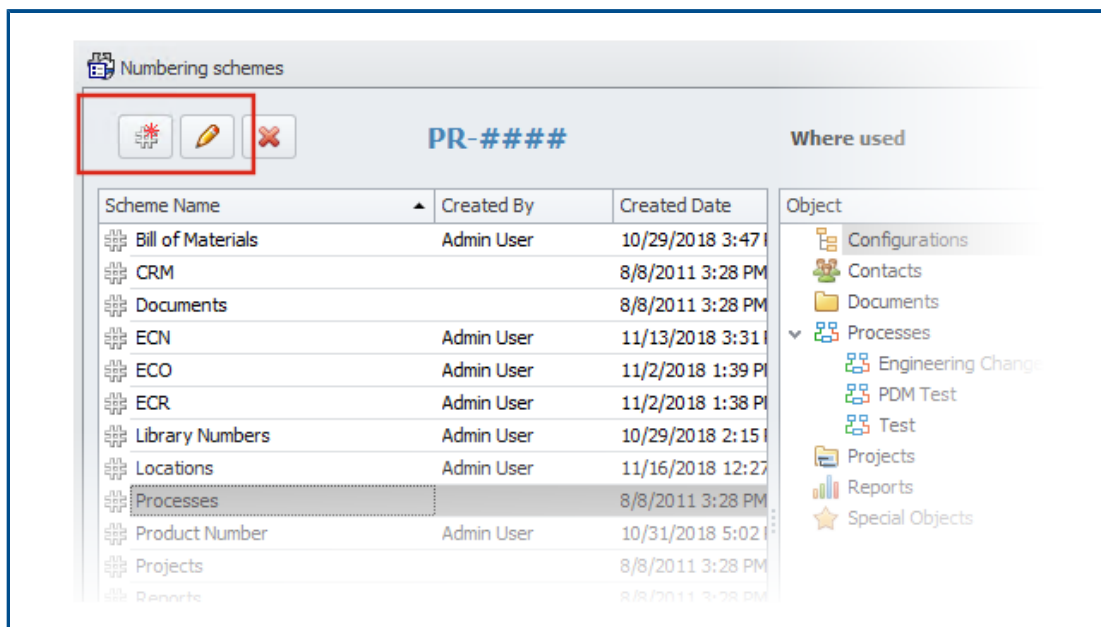

When you define the object or field, you can directly add or edit numbering schemes. Previously you had to close the Object properties dialog box and open the Administration tool to access the numbering schemes.

## Partial Administrators for Dashboards

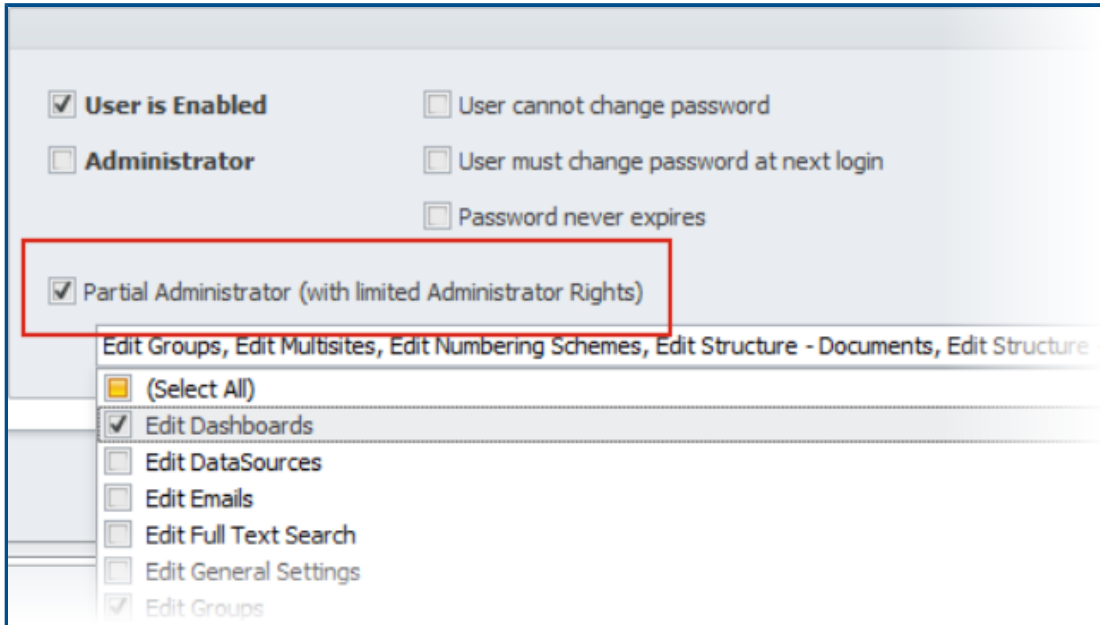

Administrators can assign partial administrators to the dashboards. Partial administrators can create and edit dashboards.

## Save as Recursive

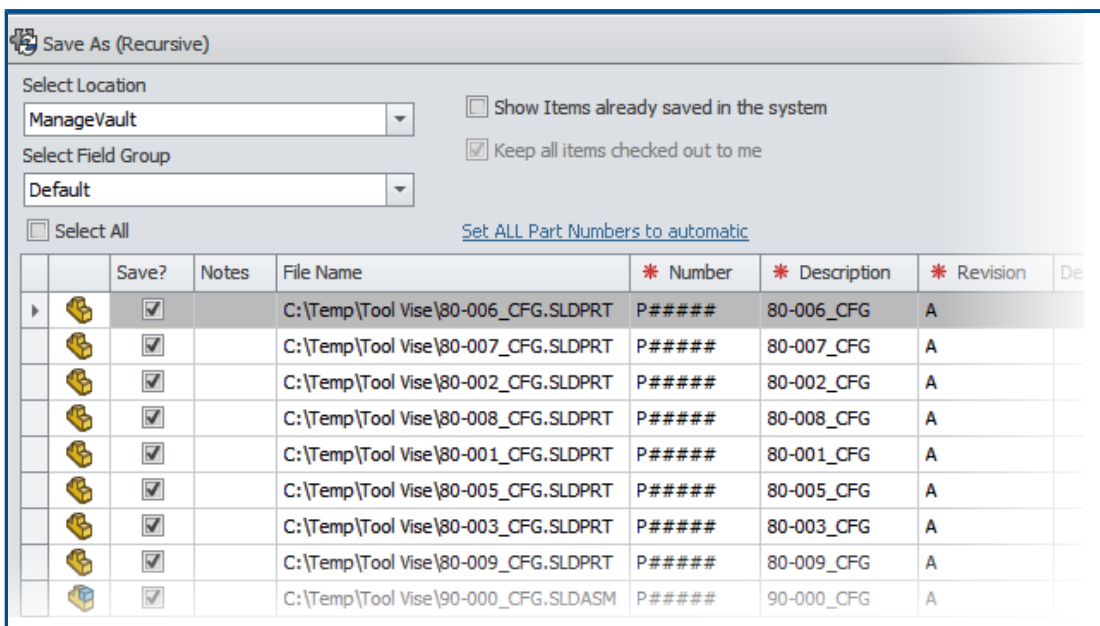

The **Save as (Recursive)** option in the SOLIDWORKS Manage add-in for SOLIDWORKS imports assemblies and references. It also applies the numbering scheme defined in SOLIDWORKS Manage to those assembly structures.

To access this option, in the **Structure** view, right-click, and select **Save as (Recursive)**. You can enter other field values and read pre-existing custom properties in files.

## Viewer Licenses

Users who log in with a Viewer license can accept a process and send it to the next stage.

Some processes have outputs that create new records including new processes. If the newly created processes are not allowed by the Viewer license, then the users cannot create or participate in any stage of the process. However, they can create subprocesses.

## Multi-Language Display Names

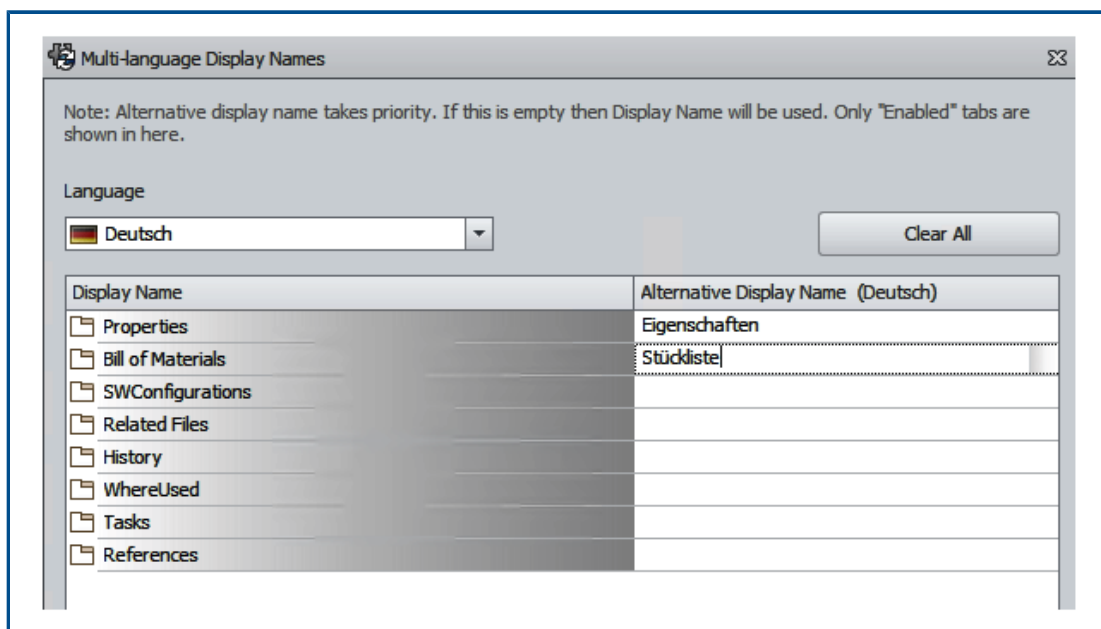

Users who use different language versions of SOLIDWORKS Manage can enter the text in different languages.

The text includes field display names, property card tabs, and module names. The administrator can define the display names specific to languages in the Administration tool. This enhancement lets each user see most of the user interface in their native language.



## Controlling Field Values

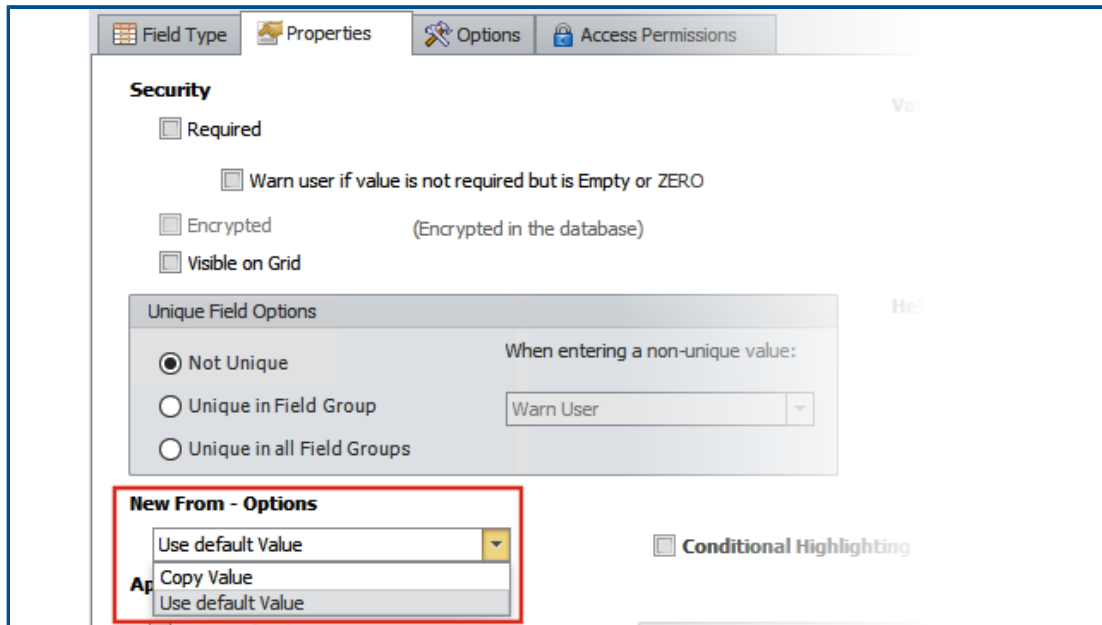

When you create a record using the **Copy From** function, the administrator of an object can:

- Clear the field values
- Set field values to their default values

## Optionally Upgrading the Database

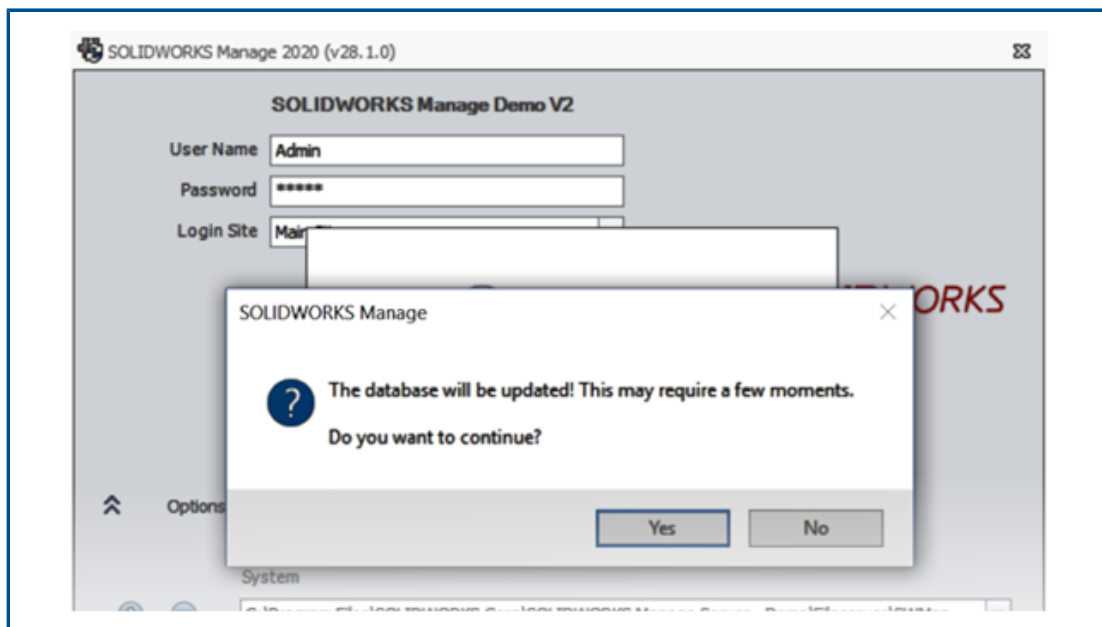

When you upgrade a client and log in to the environment, SOLIDWORKS Manage lets you optionally upgrade the database.

If you choose not to upgrade the database, the database remains unchanged and you cannot use it with the upgraded client. Previously, when you upgraded the client, the database upgraded automatically too.

## File Sharing Option

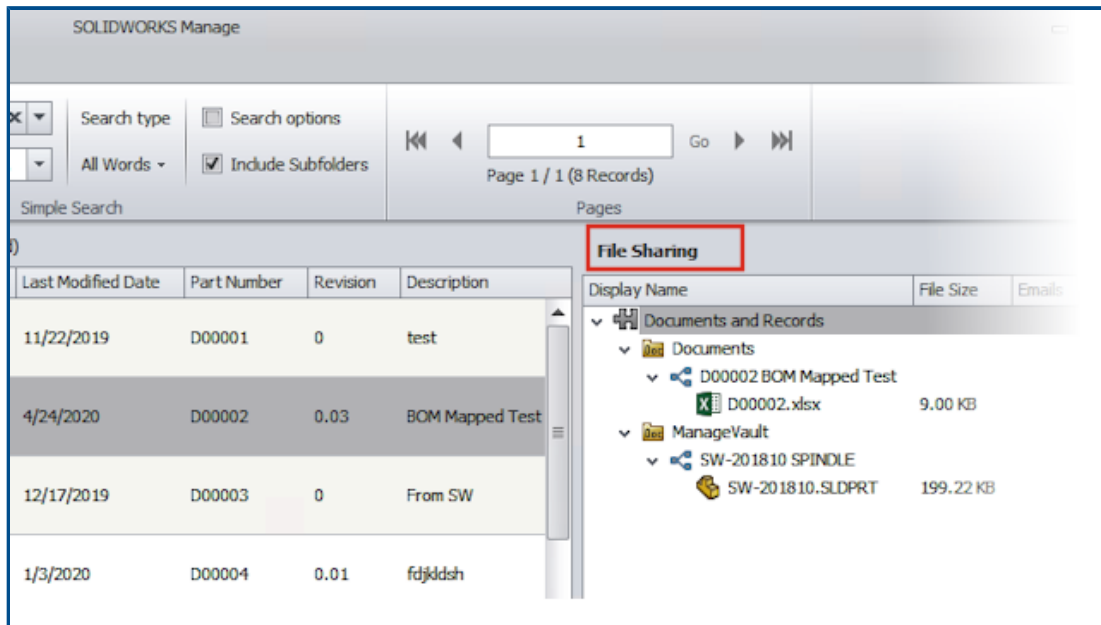

You can share files from SOLIDWORKS Manage with anyone, even if they do not have SOLIDWORKS Manage installed.

To share a file, right-click and select **Share**. You can then edit settings for each shared file from the File Sharing tab in both the desktop and the Plenary web client interface.

The **Share** command creates a special link to the files through the Plenary web client. You can copy, email, and password protect this link. You can also define a time limit after which the link becomes invalid.

Administrators enable sharing for users and groups and define limits on the number of files that can be shared simultaneously. They can also define the number of links that can be created for a particular object.

## Other SOLIDWORKS Manage Enhancements

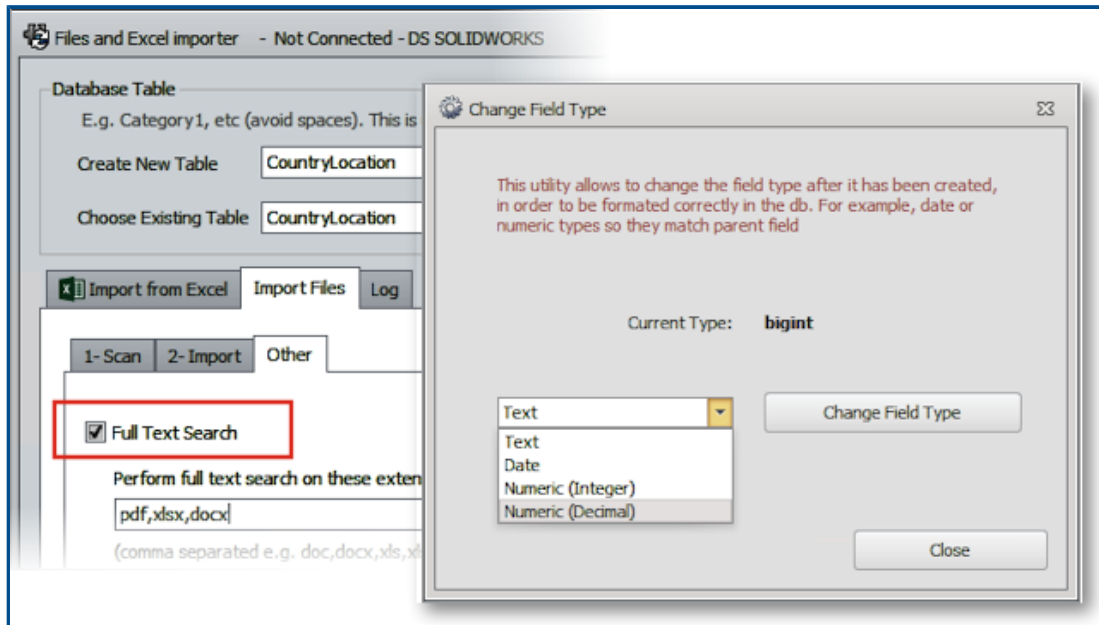

Other enhancements for SOLIDWORKS Manage include process and search improvements, and new options for administrators.

- You can do full text searches of imported files. In the Files and Excel Importer tool, specify the **Full Text Search** option.
- You can change the data type (Text, Date, or Number) of a link to a third-party field. The software warns you that it deletes incompatible data. Previously, to change the data type, you had to delete and create the field again.
- Released (approved) icons appear for status change outputs from Timesheet processes as the processes complete.
- When you add references to document objects, you can use the **File Name** column in the Add Reference(s) dialog box to quickly find records.
- In the Process Wizard, on the Main Configuration page, you can clear **Automatically fill process description field from affected items**.
- You can create a new project record from existing project records and add attributes such as stages, tasks, resources, and deliverables from the source project.
- The Gantt chart tools and functionality of the Project Planning tool provide better performance. The tools are more responsive when you add or edit predecessors or move stages in the Project Planning tool.
- When you save a process record, you must fill in all the required fields at each stage.

If you want to receive a warning when you do not fill all the required fields, in the Process Wizard, select **All process fields must be completed when a process is created**.

- Administrators can control the layout of main grids and prohibit users from saving their changes.

The changes that the users make are applicable for the ongoing session only. When they log in again, they get the default configuration saved by the administrators.

- Administrators can enter a password instead of getting a system-generated password when they reset passwords for external users.

# 14

## SOLIDWORKS Simulation

---

This chapter includes the following topics:

- **Terminology Updates for SOLIDWORKS Simulation**
- **Contact Stabilization**
- **Robust Default Interaction Settings**
- **Improved Bonded Formulation**
- **Geometry Corrections for Surfaces in Contact**
- **Switch Source and Target Faces for Local Interactions**
- **Default Mesh Settings**
- **Enhanced Blended Curvature-Based Mesher**
- **Mesh Quality-Diagnostics Tool**
- **Simulation Solvers**
- **Improved Post-Processing for Very Large Models**
- **Simulation Evaluator**
- **Pin Connector Forces**
- **Copy Tabular Simulation Results to Clipboard**
- **Performance Improvements in SOLIDWORKS Simulation Professional and SOLIDWORKS Simulation Premium**

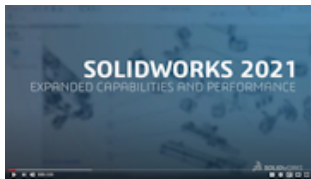

**Video: What's New in SOLIDWORKS 2021 - Simulation**

SOLIDWORKS® Simulation Standard, SOLIDWORKS Simulation Professional, and SOLIDWORKS Simulation Premium are separately purchased products that you can use with SOLIDWORKS Standard, SOLIDWORKS Professional, and SOLIDWORKS Premium.

## Terminology Updates for SOLIDWORKS Simulation

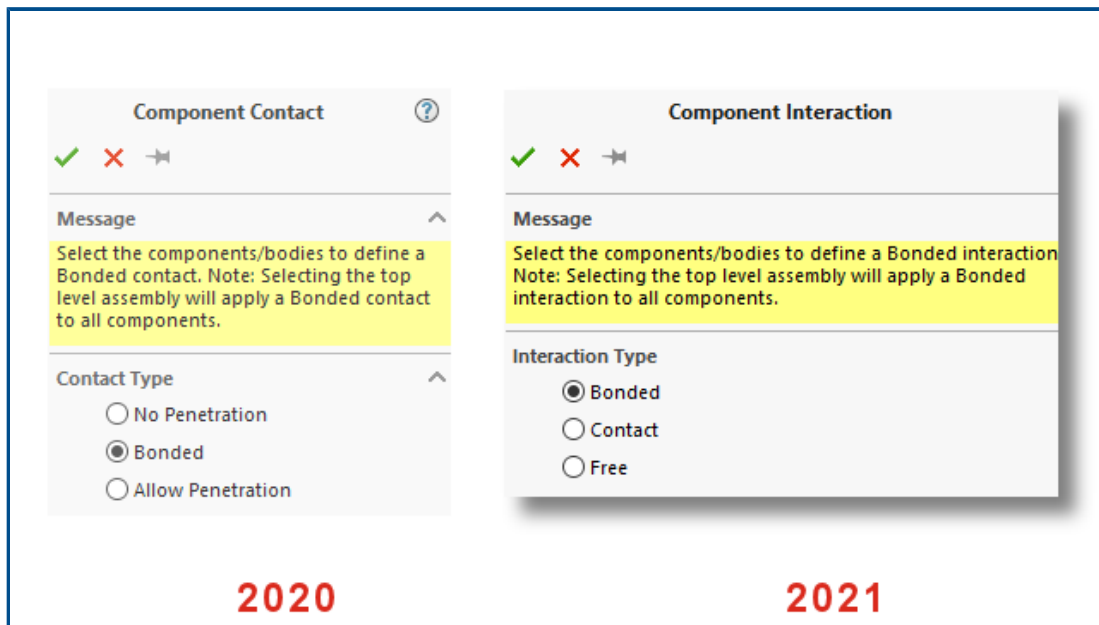

User interface terms related to contact and mesh are updated to match conventional industry terminology. The term Interaction is introduced to describe the type of behavior between components during a simulation (bonded, contact, or free).

As in previous releases, you specify the type of interactions between components at three levels:

- |                              |   |
|------------------------------|---|
| <b>Global Interaction</b>    | Defines the conditions that apply to all components. Specify the default global interaction conditions in the new <b>Simulation Options &gt; Default Options &gt; Interaction</b> dialog box. |
| <b>Component Interaction</b> | Defines the conditions that apply to selected components in the Component Interaction PropertyManager.  |
| <b>Local Interaction</b>     | Defines the conditions that apply to selected sets of geometric entities in the Local Interactions PropertyManager.   |

Local interactions settings override component-level interactions, while component-level interactions override global-level interactions.

The interface term for the **No Penetration** interaction type is replaced with the term **Contact**. The term for the **Allow Penetration** interaction type is replaced with the term **Free**.

For the **Bonded** interaction type, the term **Incompatible mesh** is removed from the user interface. In SOLIDWORKS Simulation 2021, improved algorithms make the bonding formulation for components that mesh independently more robust and accurate (known previously as incompatible bonding). The option to bond components by enforcing common mesh nodes at their boundaries (known previously as compatible bonding) is still available. When you select **Enforce Common Nodes at Touching Boundaries**, the selected components are meshed as one body. These components behave as if they are welded at their touching boundaries.

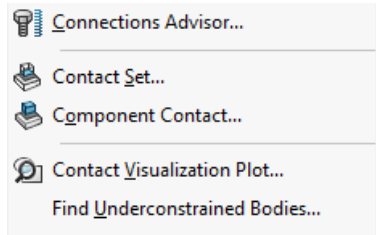
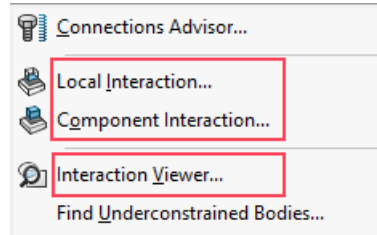
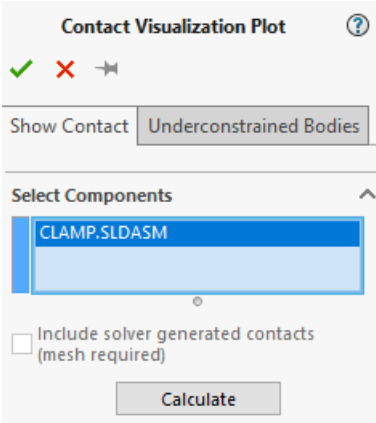
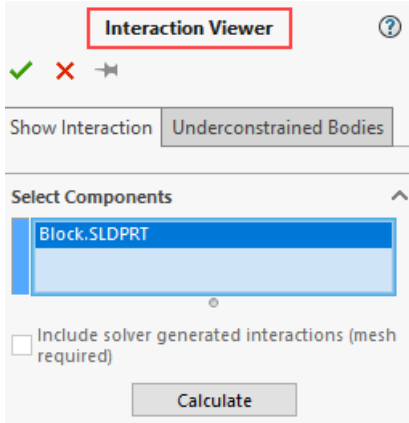
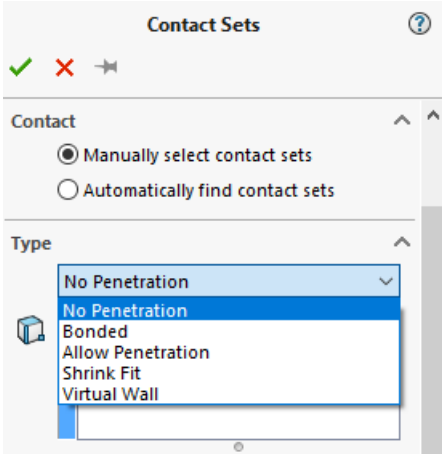
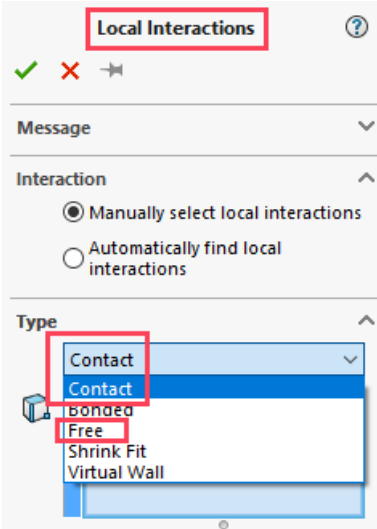
SOLIDWORKS Simulation 2020 - User Interface	SOLIDWORKS Simulation 2021 - User Interface
	
	
	
<p><b>Contact Sets &gt; No penetration</b></p>	<p><b>Local Interactions &gt; Contact</b></p>

SOLIDWORKS Simulation 2020 - User Interface	SOLIDWORKS Simulation 2021 - User Interface
<p><input checked="" type="checkbox"/> Gap (clearance)</p> <p><input type="radio"/> Always ignore clearance</p> <p><input checked="" type="radio"/> Ignore clearance only if gap is less than:</p> <p><input type="checkbox"/> 0.001 in</p>	<p><input checked="" type="checkbox"/> Contact offset</p> <p><input checked="" type="radio"/> If gap is less than</p> <p><input type="checkbox"/> Unlimited gap distance</p> <p>0.001 in</p> <p><b>Unlimited gap distance</b> replaces legacy option <b>Always ignore clearance</b>.</p> <p><b>If gap is less than</b> replaces legacy option <b>Ignore clearance only if gap is less than</b>.</p>
<p><b>Component Contact &gt; Bonded</b></p> <p>Options</p> <p><input checked="" type="radio"/> Compatible mesh</p> <p><input type="radio"/> Incompatible mesh</p> <p><input type="checkbox"/> Non-touching faces</p>	<p><b>Component Interactions &gt; Bonded</b></p> <p>Advanced</p> <p><input checked="" type="checkbox"/> Enforce common nodes between touching boundaries</p> <p>Bonding formulation:</p> <p><input checked="" type="radio"/> Surface to surface</p> <p><input type="radio"/> Node to surface</p>

### Contact Stabilization

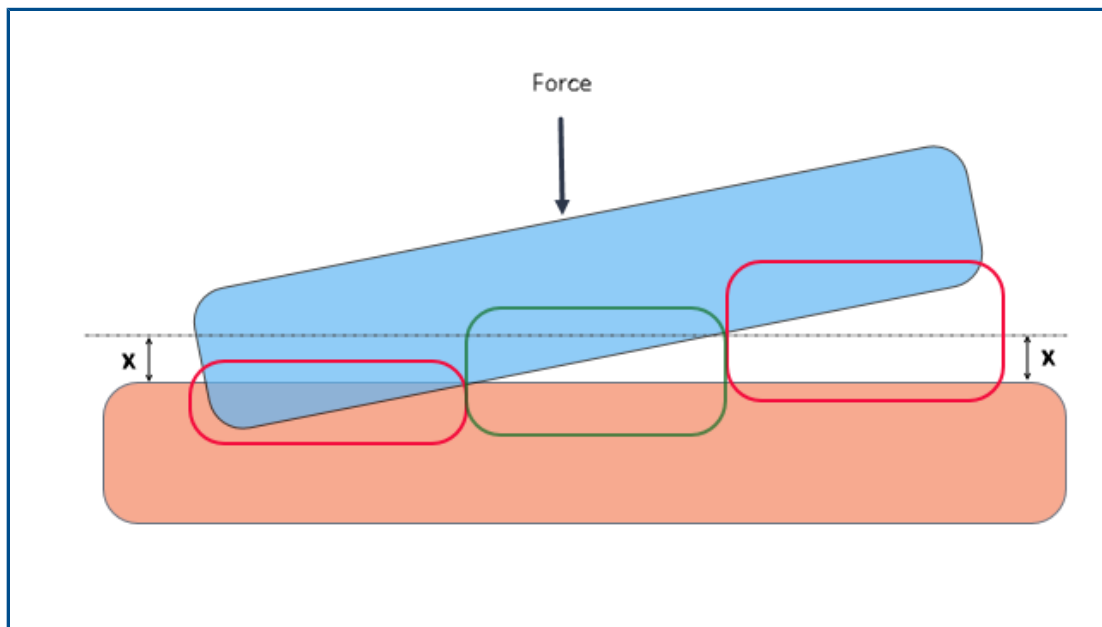



Contact detection is enhanced with a contact stabilization algorithm that can resolve under-constrained conditions. Contact stabilization acts as a numerical stabilizer by adding a small stiffness to qualified areas before they come into contact.

With contact stabilization, the solver can resolve instability issues encountered at the start of the solution before contact is initiated. You can specify the threshold value of the clearance between geometric entities to qualify them for contact stabilization. You set the clearance in:

**Default Options > Interaction > Stabilize the area if the gap is *value* % of characteristic length.**

By default, the software always applies contact stabilization to geometries that have an initial clearance within a threshold value of 1% of the model's characteristic length.

For example, for the two bodies that come into contact as shown in the image above, areas within the green frame qualify for contact stabilization because their clearances are within the gap threshold ( $x$ ). Areas inside the red frame do not qualify for contact stabilization because they are either interfering or their clearance exceeds the gap threshold.

### Application of Contact Stabilization

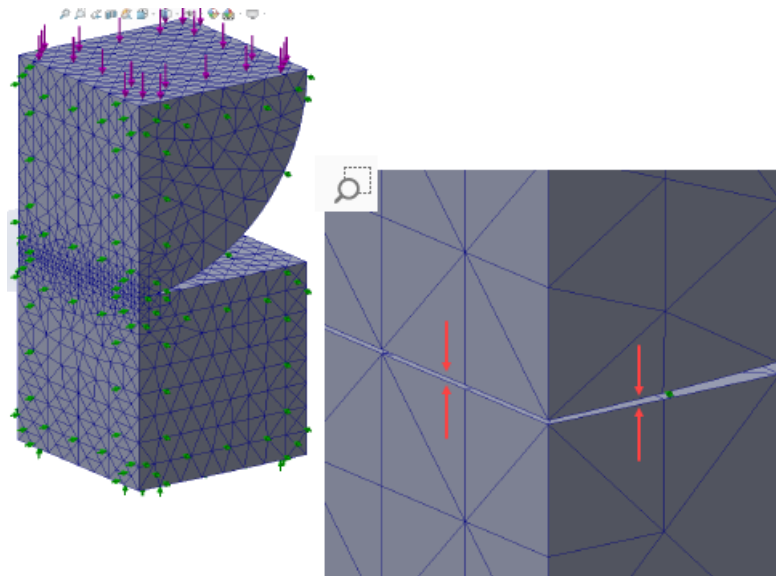

Example of two bodies that have an initial clearance and come into contact under load application. Contact stabilization enables the accurate solution in SOLIDWORKS Simulation 2021.

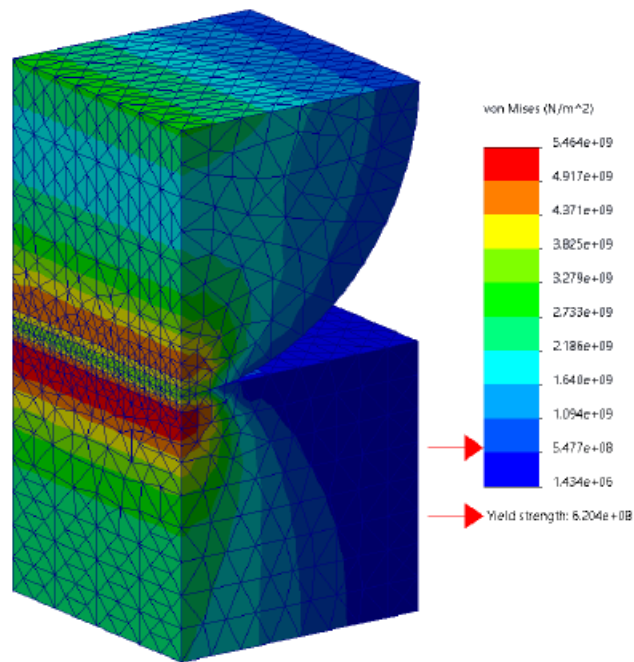

Accurate stress plot results with the enablement of contact stabilization in SOLIDWORKS Simulation 2021.

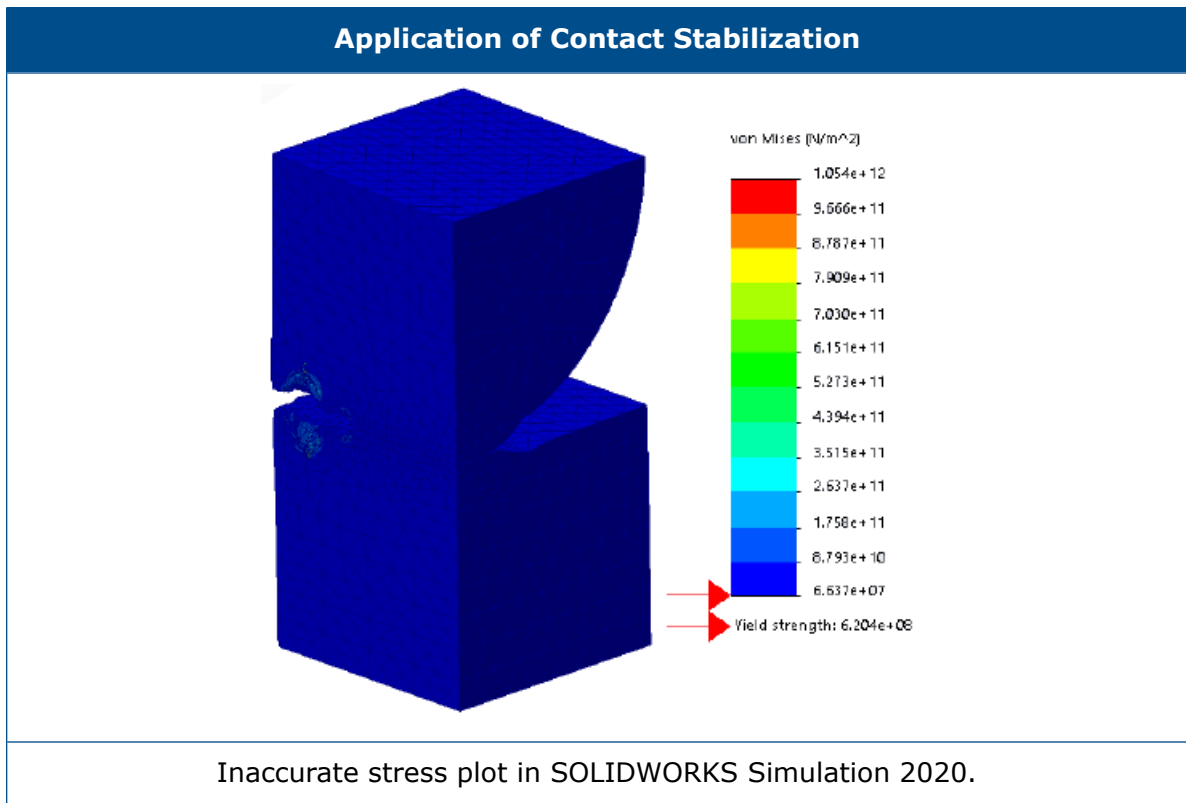

## Robust Default Interaction Settings

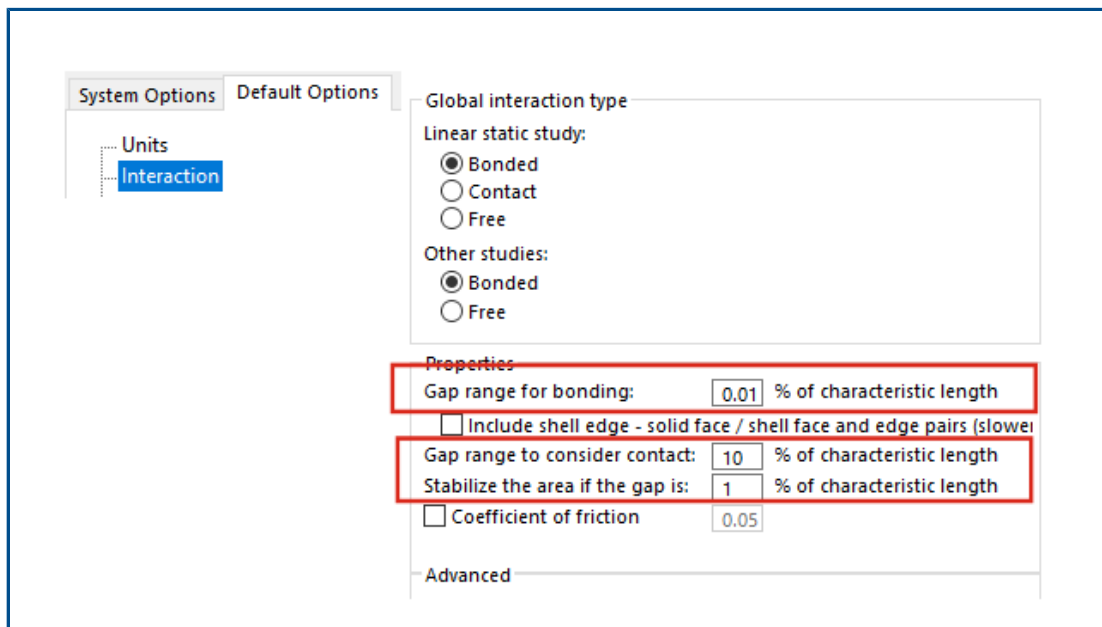

Simulations that have bonded and contact definitions are more robust, even for models with slightly imperfect geometries. Algorithms that detect clearances between geometries

and enforce appropriate interactions are improved, and user interface selections are simplified.

Enhancements for defining interactions between geometries include:

- Separate options to set the global interaction type for linear static and other studies (**Default Options > Interaction > Global interaction type > Bonded, Contact, or Free**).
- Global settings for qualifying areas propagate to the component interaction and local interaction definitions. The default global settings for new studies ensure that simulations can run even for models with slightly imperfect geometries. The software calculates the qualified regions based on a percentage of the characteristic length of the participating geometries.

#### Global Default Options - Interactions Description

<b>Gap range for bonding: 0.01% of characteristic length</b>	Geometry entities that are within this clearance qualify for a bonding definition.
<b>Gap range to consider contact: 10 % of characteristic length</b>	Geometry entities that are within this clearance qualify for a contact definition.
<b>Stabilize the area if the gap is: 1% of characteristic length</b>	Applies a small stiffness to the qualified regions so the solver can overcome instability issues and start the simulation.

These default settings for qualifying interactions are recommended for novice users that might encounter difficulties running simulations. More experienced users can customize these settings to fit their models.

- Separate options for the global contact and bonding formulations (**Default Options > Interaction > Contact Formulation, or Bonding Formulation**).
- Removal of node-to-node contact formulation. When you open models with legacy node-to-node contact definitions, SOLIDWORKS Simulation 2021 converts them to node-to-surface contact during the analysis.

## Improved Bonded Formulation

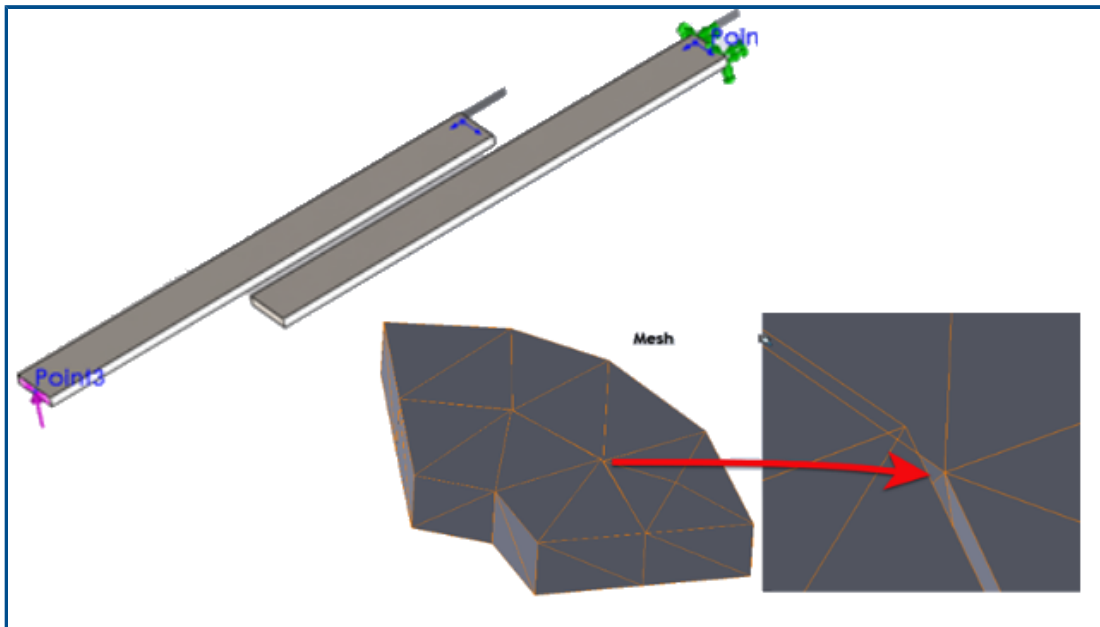

The accuracy of results for static, frequency, and buckling studies is improved for geometries that have bonded interactions. Improved algorithms that mesh bodies independently drive this improvement.

For simulations with bonded interactions between geometries, you can observe solution improvements in these cases:

- Gaps or small interferences exist between the independent meshes of geometries that are bonded, even though the actual geometries have no clearances (solid-to-solid, shell-to-shell, and solid-to-shell bonded interactions).

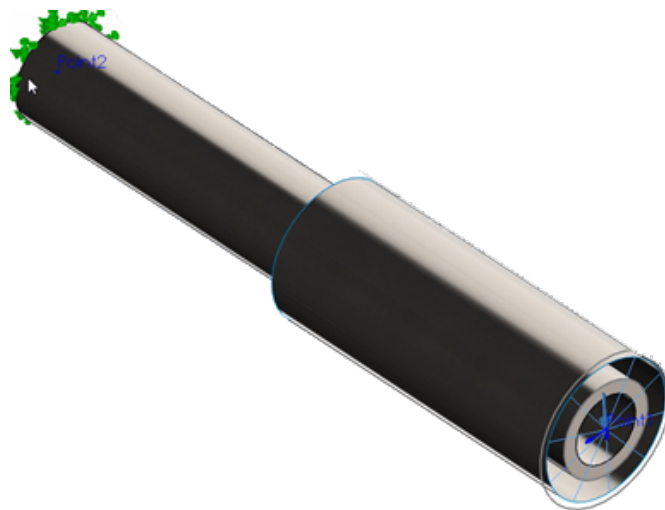

The gap between the two cylinders represents the shell thickness (inner solid body, outer shell body). In reality, the two cylinders are touching with no clearance.

- There is a physical clearance between bodies that you want to bond.
- For frequency studies, detection is accurate for the six rigid-body modes for unconstrained assemblies.
- For assemblies that experience rigid-body rotations, detection is accurate for a nearly zero stress-state

## Geometry Corrections for Surfaces in Contact

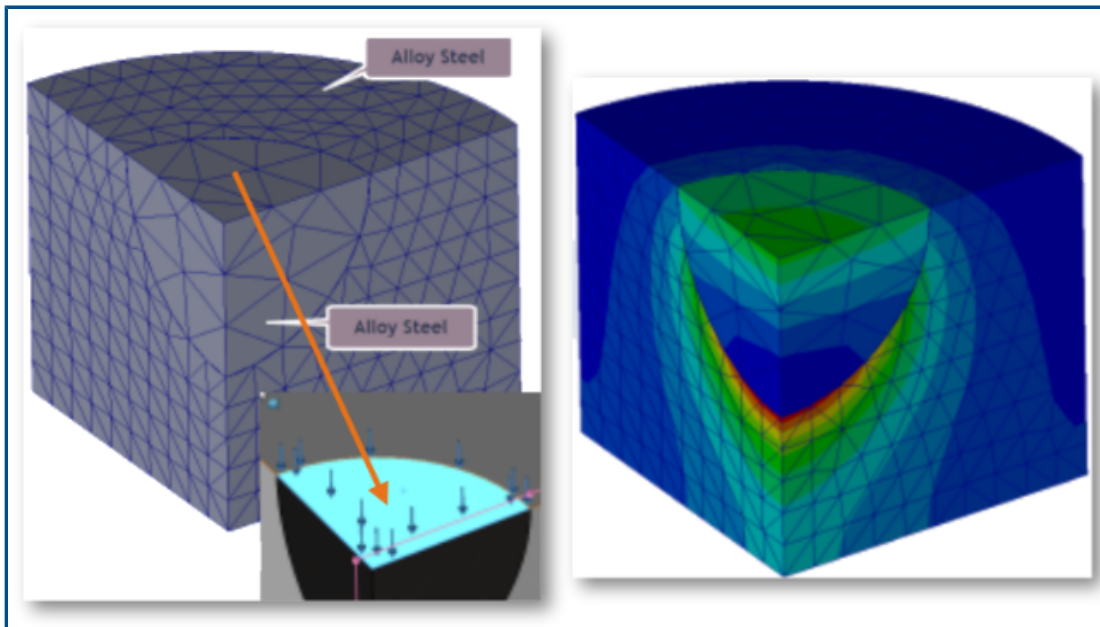

Simulations for linear static studies are more accurate for curved surfaces that come into contact.

The contact detection algorithm integrates geometry correction factors that improve the representation of curved surfaces of cylindrical, spherical, and conical geometries.

The image above shows one-quarter of a cylindrical model with a spherical cavity. The two parts mesh independently. A pressure load is applied at the top of the spherical cavity. During simulation, contact forces develop at the spherical boundaries. The stress gradient plot shown at the right represents accurately the contact behavior.

Another example where results are improved for SOLIDWORKS Simulation 2021 because of the integration of geometry correction factors in contact simulation is shown below.

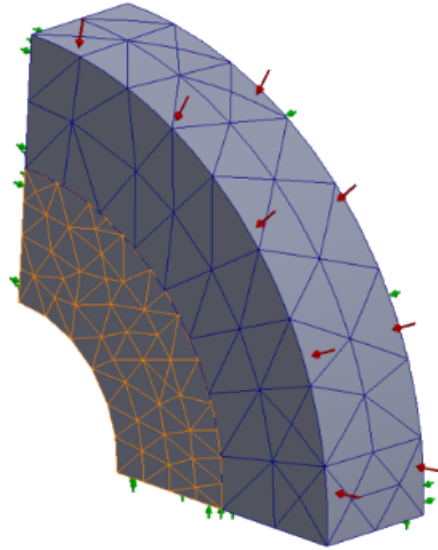

Two cylindrical bodies come into contact under a pressure load. The bodies mesh independently. The inner body has a draft-quality mesh with a higher mesh density. The outer body has a high-quality mesh with a lower mesh density.

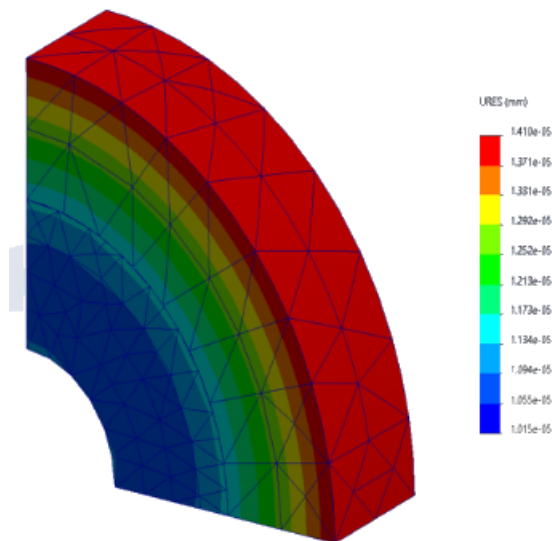

With the integration of geometry corrections, the deformation contour plot is accurate (SOLIDWORKS Simulation 2021).

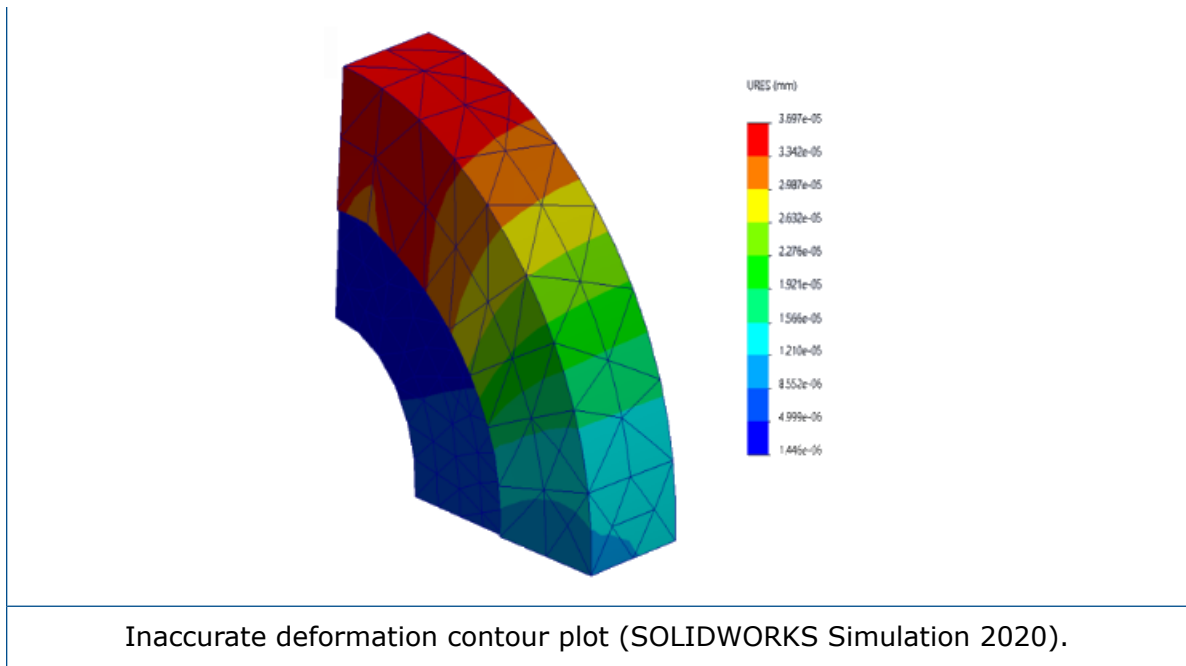

## Switch Source and Target Faces for Local Interactions

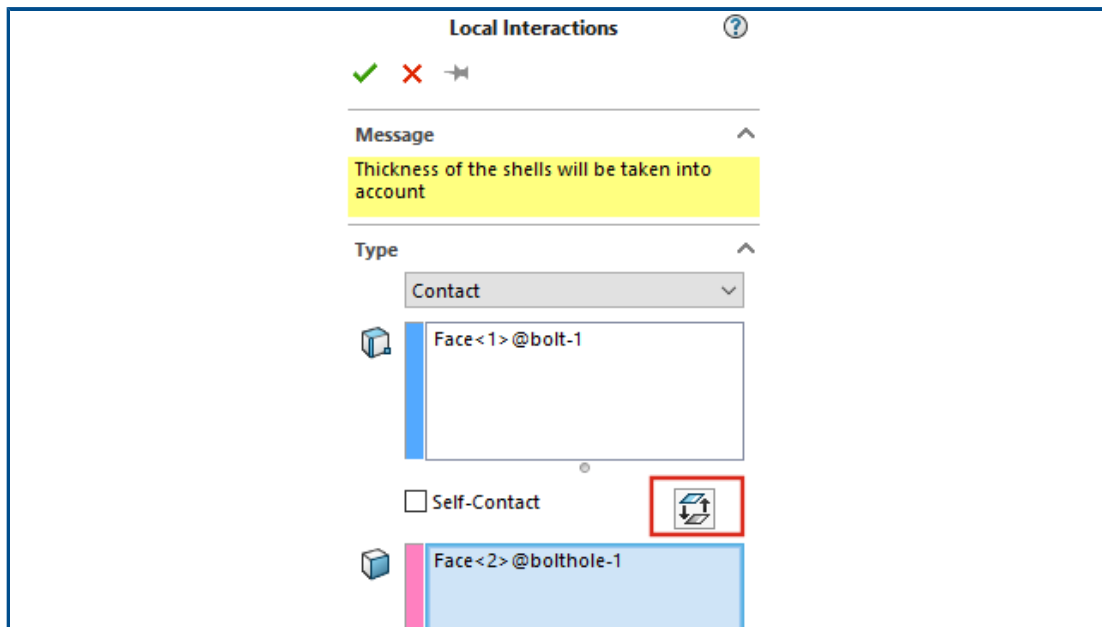

For local interactions, you can switch the geometry selections between the source and target sets to resolve convergence issues. When you are working with complex geometries that have multiple faces, switching the geometry entities between the source and target sets with the **Swap interaction faces** tool saves you time.

In the Local Interactions PropertyManager, click **Swap interaction faces** .



## Default Mesh Settings

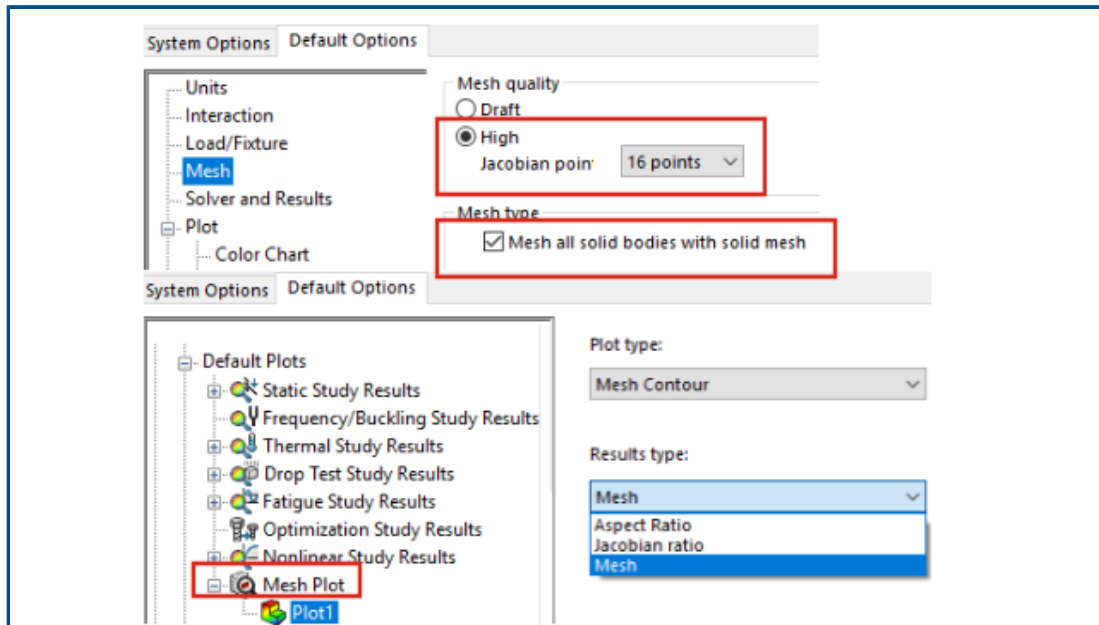

The default mesh settings for new studies facilitate mesh assignments for most models. Enhancements for mesh settings include:

- You can select the Blended curvature-based mesher as the default mesher for new studies. In the **Default Options > Mesh** dialog box, for **Mesher type**, select **Blended curvature-based**.
- A new option **Mesh all solid bodies with solid mesh (Default Options > Mesh)** allows you to mesh all solid, sheet metal, and weldment bodies with a solid mesh. Meshing all solid bodies with solid elements saves you time in preparing the model for meshing (particularly useful for novice simulation users), but can increase the overall solution time.
- At a study level, you can override the mesh assignments enforced by the option **Mesh all solid bodies with solid mesh**. In a simulation study tree, right-click the top **Parts** folder, and select **Treat all sheet metals as shells**, or **Treat all weldments as beams**.
- You can select the type of a mesh contour plot that becomes visible after meshing in the new dialog box **Default Options > Plot > Mesh Plot**.
- For new studies, the default setting for a mesh quality plot based on the Jacobian ratio is **16 points**.

## Enhanced Blended Curvature-Based Mesher

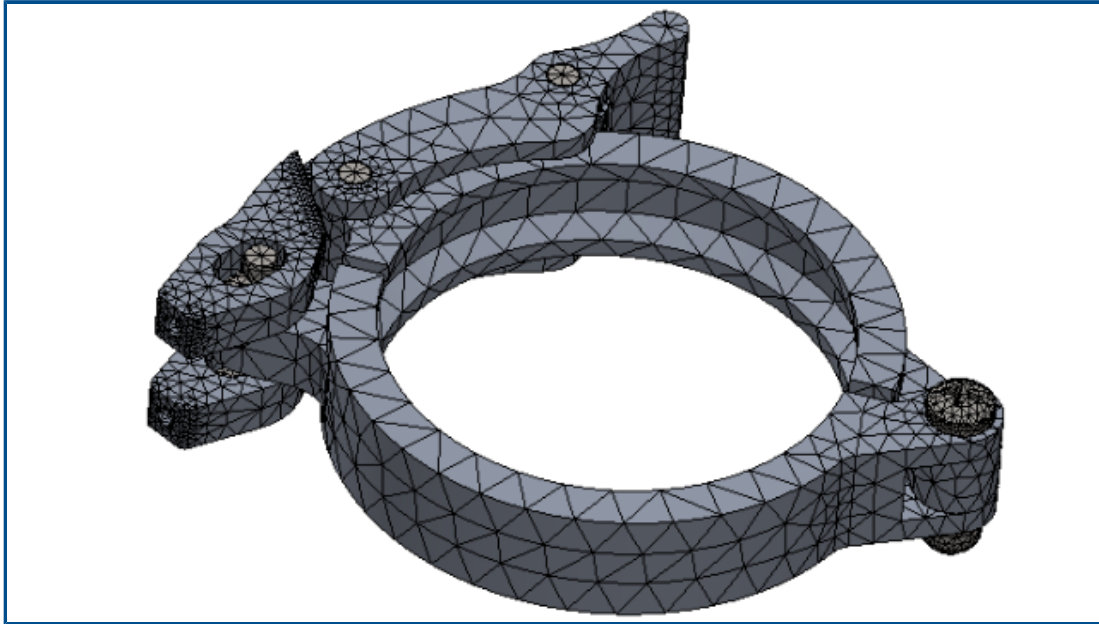

The Blended Curvature-based mesher has improved performance based on optimized code architecture, multithreading, and parallel multicore processing. The improved mesher can mesh parts and large assemblies significantly faster.

It can also mesh models that previously failed to mesh. In addition, mesh cancellation is immediate, and performance issues including program termination that are related to mesh cancellation are resolved. These performance improvements also apply to the Curvature-based mesher.

For example, for the clamp assembly with 11 parts shown above, mesh generation with the enhanced Blended Curvature-based mesher is approximately 5 times faster. The table lists the mesh details of the clamp assembly model for the 2020 and 2021 releases.

<b>Mesh Details</b>	<b>2020</b>	<b>2021</b>
Mesher	Blended Curvature-based	Enhanced Blended Curvature-based
Mesh Type	Solid	Solid
Maximum element size/ Minimum element size	5.815 mm / 0.291 mm	5.815 mm / 0.291 mm
Total nodes / total elements	45,918 / 26,490	46,729 / 27,028
Time to complete mesh (minutes:seconds)	0:50	00:11

The performance improvement of the enhanced Blended Curvature-based mesher depends on the number of parts in an assembly, the number of physical cores, and available memory.

The table lists the SOLIDWORKS Simulation licenses that support single-core processing and multicore processing for the Blended Curvature-based mesher.

<b>Mesher</b>	<b>Licenses with Single-core Processing</b>	<b>Licenses with Multicore Processing</b>
Blended Curvature-based (surface meshing)	<ul style="list-style-type: none"> <li>• Simulation Xpress</li> <li>• Simulation in SOLIDWORKS Premium</li> <li>• SOLIDWORKS Simulation Standard</li> </ul>	<ul style="list-style-type: none"> <li>• SOLIDWORKS Simulation Professional</li> <li>• SOLIDWORKS Simulation Premium</li> </ul> <p>There is no limit to the number of physical cores that the Blended</p>

Mesher	Licenses with Single-core Processing	Licenses with Multicore Processing
		Curvature-based mesher can access.

## Mesh Quality-Diagnostics Tool

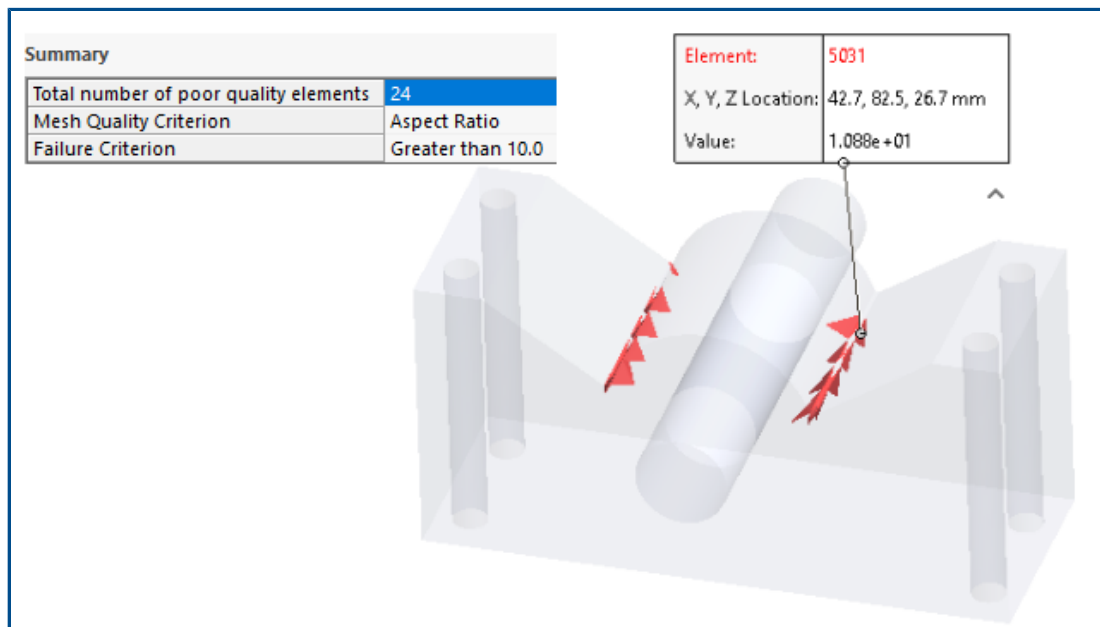

Improved diagnostic tools help you examine the quality of a mesh and detect poor-quality elements.

After meshing, right-click **Mesh** (Simulation study tree), and select **Mesh Quality Diagnostics**. The **Mesh Quality Diagnostics** plots display the Jacobian ratio, Aspect ratio, or Element volume for the whole model or selected bodies. By default, the software evaluates an element with a Jacobian ratio and Aspect ratio greater than 20 as poor quality. You can edit the default value to evaluate poor quality elements. For example, in the image above 24 elements are highlighted as poor quality based on the failure criterion for Aspect ratio greater than 10.

To isolate poor-quality elements:

1. In the Mesh Quality Diagnostics PropertyManager, under **Advanced Options**, select **Switch to Probe and Diagnose when poor quality elements are detected**.
2. In the Probe and Diagnose PropertyManager, select **Isolate poor quality elements**.
3. Click **Mesh Helper** to get assistance refining the mesh at key areas and resolve mesh quality issues before proceeding with the analysis.

## Simulation Solvers

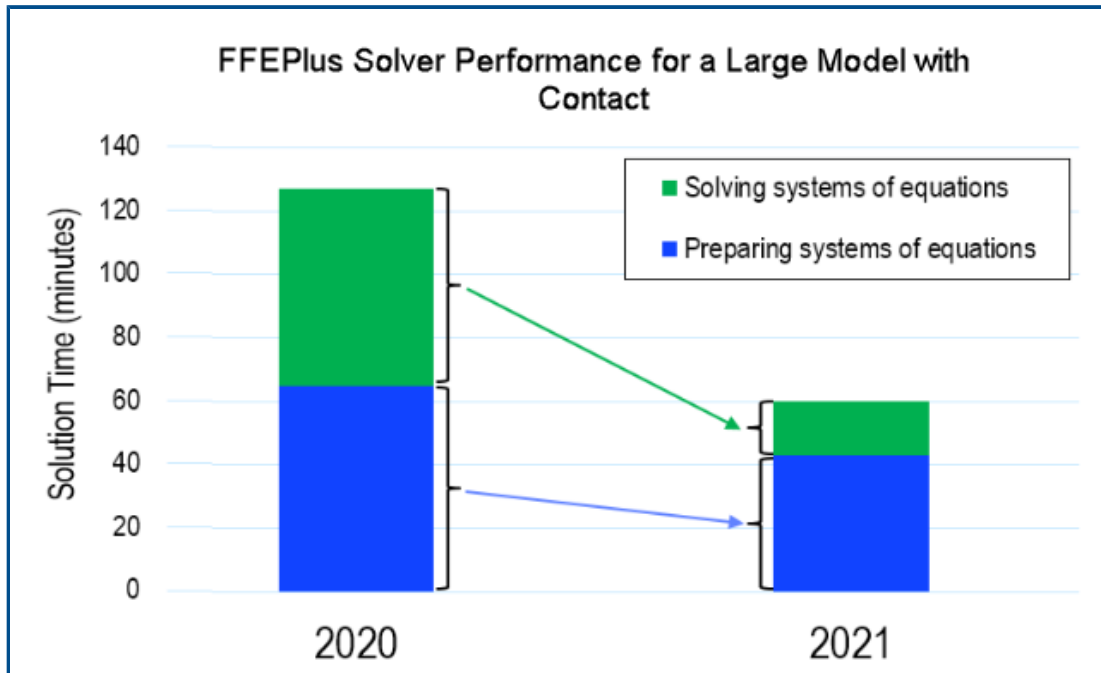

The solution time of linear static studies with many surface-to-surface contact elements is improved. The **Intel Direct Sparse** solver can handle linear static and nonlinear studies with more than 4 million equations.

The image shows the total solution time in minutes for a linear static analysis of a large model solved with the **FFEPlus Iterative** solver. The model has 1.0 million tetrahedron elements and 0.5 million contact elements with friction. Because of the **FFEPlus** solver enhancements in SOLIDWORKS Simulation 2021, the overall solution time for this particular model that has 1/3 surface-to-surface contact elements of all total elements is decreased by more than 50%.

- **FFEPlus Iterative**

The solution time for linear static studies is improved by using parallel multicore processing to calculate the stiffness for surface-to-surface contact elements.

The transfer of stiffness data to solve the systems of equations is optimized because file-based processing is replaced with function-based processing.

These performance gains are more apparent for large models that have at least 10% contact elements of the total elements.

Function-based processing is not implemented for models that include any of these features:

- Connectors: spring, bearing, bolt, and rigid connector
- Node-to-surface contact, virtual wall contact, cyclic symmetry, remote load with rigid connection, and beams acting as stiffeners.

These limitations also apply to the **Large Problem Direct Sparse** solver.

- **Intel Direct Sparse**

The solver can handle significantly larger linear and nonlinear simulation studies by taking full advantage of available memory. When the solver exceeds the available memory, it uses available disk space to run the simulation.

The solver can run simulations for linear static and nonlinear studies with more than 4 million equations.

- **Large Problem Direct Sparse**

The solver has limited performance improvement based on improved function-based data transfer of stiffness data and parallel multicore processing to calculate the stiffness for surface-to-surface contact elements for linear static studies.

- **Automatic Solver Selection**

The algorithm that selects the best equation solver for linear static studies is optimized. The selection of the best equation solver (**Intel Direct Sparse** or **FFEPlus Iterative**) depends on: the number of equations, load cases, mesh type, geometric features, contact and connector features, and available system memory.

- **Manual Solver Selection**

The user interface for manual solver selection is improved to provide quick access to the most efficient solvers. To view all available solvers, in the Options dialog box, select **Solver > Manual > More Solvers**.

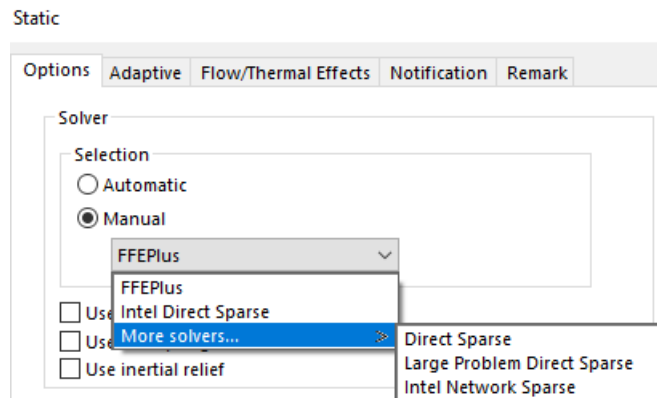

- **Multicore Processing**

The table lists the multicore processing specifications of simulation solvers for each Simulation license.

Solvers	Simulation Licenses - Limited to Maximum of 8 Physical Cores	Simulation Licenses - No Limit on Number of Physical Cores
<ul style="list-style-type: none"> <li>• <b>FFEPlus</b></li> <li>• <b>Intel Direct Sparse</b></li> <li>• <b>Direct Sparse</b></li> <li>• <b>Large Problem Direct Sparse</b></li> <li>• <b>Intel Network Sparse</b></li> </ul>	<ul style="list-style-type: none"> <li>• Simulation Xpress</li> </ul> <div data-bbox="716 386 1040 510" style="border: 1px solid gray; padding: 5px; margin: 5px 0;">                     FFEPlus is the only solver option for Simulation Xpress.                 </div> <ul style="list-style-type: none"> <li>• Simulation in SOLIDWORKS Premium</li> <li>• SOLIDWORKS Simulation Standard</li> </ul>	<ul style="list-style-type: none"> <li>• SOLIDWORKS Simulation Professional</li> <li>• SOLIDWORKS Simulation Premium</li> </ul>

### Improved Post-Processing for Very Large Models

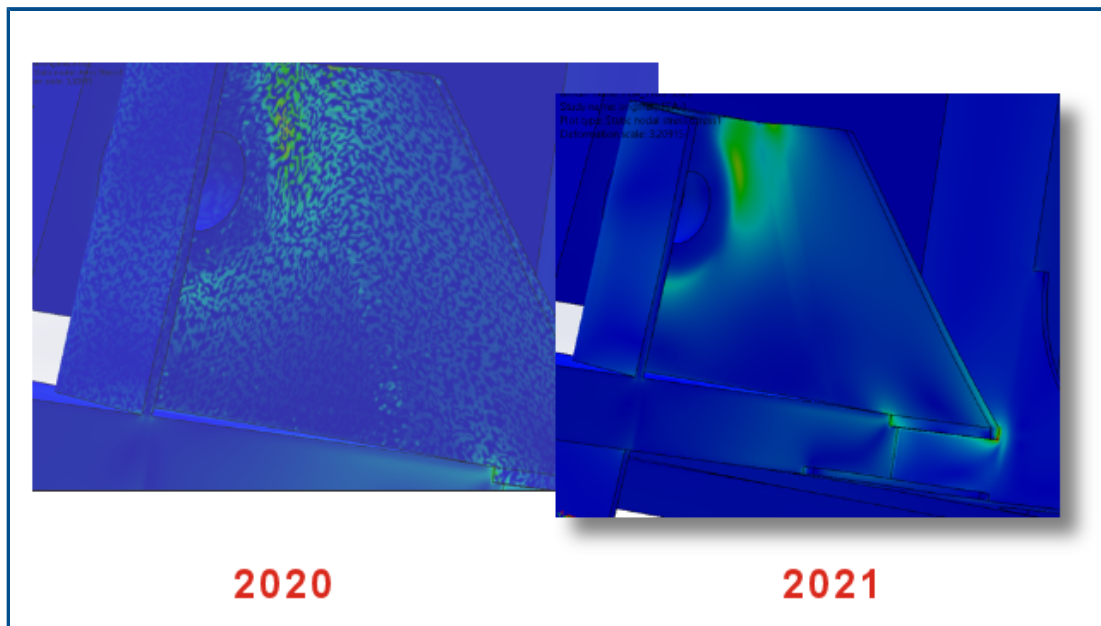

The post-processing of stress and strain results is enhanced for models that have more than 10 million elements.

The software can list simulation results and process stress and strain contour plots for very large models that have up to 2,000 million elements.

This improvement applies to Linear Static, Nonlinear, Fatigue, Linear Dynamic, and Topology studies.

## Simulation Evaluator

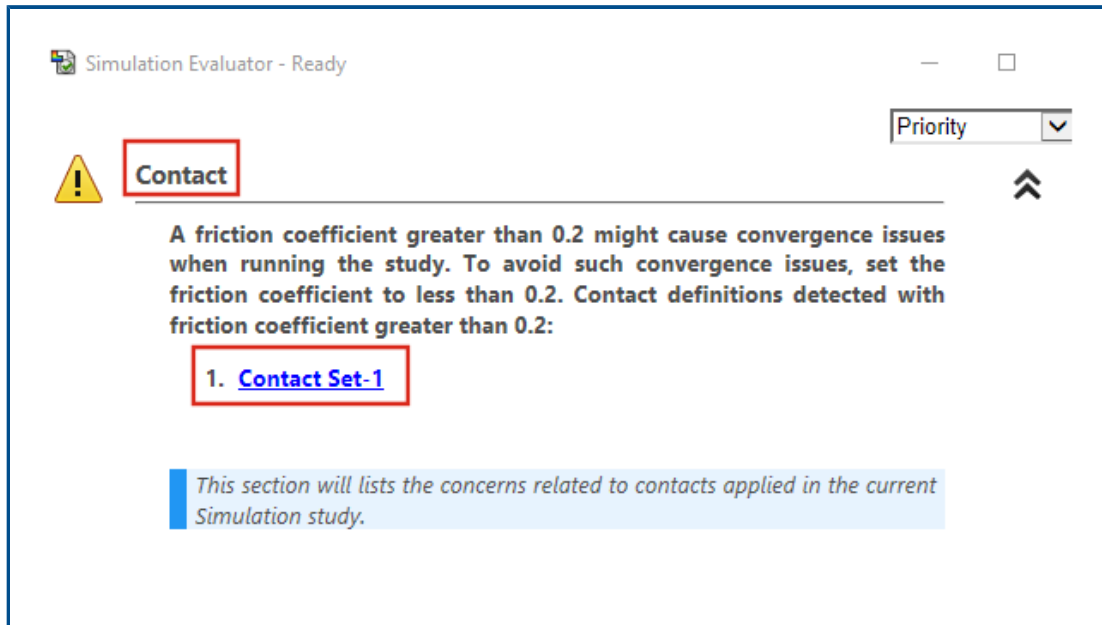

The Simulation Evaluator is enhanced to flag study definitions related to the assigned friction coefficient for contacts and materials for invalid Poisson's ratio values.

The Simulation Evaluator flags interactions that have a coefficient of friction greater than 0.2 indicating possible convergence issues. For linear static studies, it detects material definitions with a Poisson's ratio larger than 0.5, which is an invalid definition.

## Pin Connector Forces

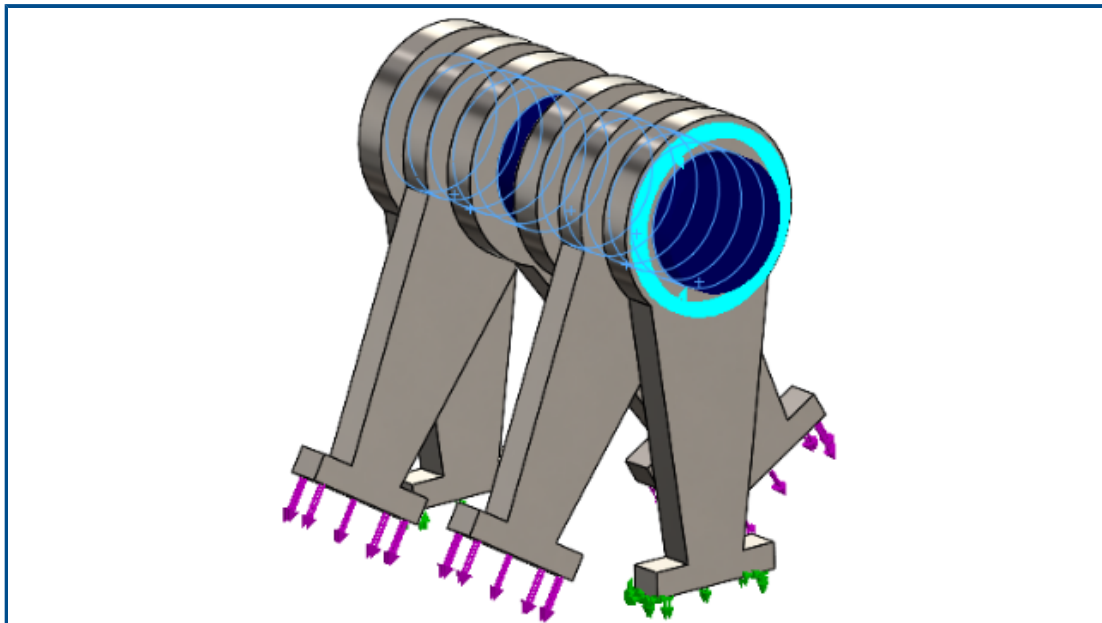



Listing pin connector loads at the pin joints is more accurate for shear forces and bending moments in the global or a user-defined coordinate system.

The direction of applied loads along the pin connector is taken into account when listing pin connector loads. Although the vector representing the direction of axial force and torque remains the same for all pin joints, the direction of the shear force and bending moment vectors can change from one joint to another.

The local pin axis is a vector that connects the first pin joint to the last joint. The list of pin loads includes the axial force and torque along the local pin axis. The shear forces and bending moments are normal to the pin's axial vector.

The table lists the connector forces of the six-part assembly connected with a multijoint pin (6 joints) shown above. The forces exerted on the pin connector act at an angle measured from the pin axis. In SOLIDWORKS Simulation 2021, the connector shear forces and bending moments are more accurate because their directions are correctly defined at each pin joint.

### List of Connector Forces (2021)

Connector Force					
Type	Resultant	X-Component	Y-Component	Z-Component	Connector
Shear Force (N)	173.21	-173.21	3.4231e-05	0	Pin Connector-1 Joint 1
Axial Force (N)	-6.7774e-06	-0	-0	6.7774e-06	Pin Connector-1 Joint 1
Bending moment (N.m)	4.1983e-08	4.0677e-10	4.1981e-08	0	Pin Connector-1 Joint 1
Torque (N.m)	1.22e-16	0	0	-1.22e-16	Pin Connector-1 Joint 1
Shear Force (N)	173.21	173.21	-3.4231e-05	0	Pin Connector-1 Joint 2
Axial Force (N)	6.7774e-06	0	0	-6.7774e-06	Pin Connector-1 Joint 2
Bending moment (N.m)	19.353	4.9085e-06	-19.353	0	Pin Connector-1 Joint 2
Torque (N.m)	-1.637e-10	-0	-0	1.637e-10	Pin Connector-1 Joint 2
Shear Force (N)	100	86.605	50	0	Pin Connector-1 Joint 3
Axial Force (N)	5.0077e-06	0	0	-5.0077e-06	Pin Connector-1 Joint 3
Bending moment (N.m)	45.16	-8.5345	44.346	0	Pin Connector-1 Joint 3
Torque (N.m)	-1.8551e-10	-0	-0	1.8551e-10	Pin Connector-1 Joint 3
Shear Force (N)	99.998	86.6	50	0	Pin Connector-1 Joint 4

### List of Connector Forces (2020)

Connector Force					
Type	Resultant	X-Component	Y-Component	Z-Component	Connector
Shear Force (N)	173.21	173.21	-3.4231e-05	0	Pin Connector-1 Joint 1
Axial Force (N)	6.7774e-06	0	0	-6.7774e-06	Pin Connector-1 Joint 1
Bending moment (N.m)	0.0002049	-1.9852e-06	-0.00020489	0	Pin Connector-1 Joint 1
Torque (N.m)	-1.22e-16	-0	-0	1.22e-16	Pin Connector-1 Joint 1
Shear Force (N)	173.21	173.21	-3.4231e-05	0	Pin Connector-1 Joint 2
Axial Force (N)	6.7774e-06	0	0	-6.7774e-06	Pin Connector-1 Joint 2
Bending moment (N.m)	4.3992	-0.042624	-4.399	0	Pin Connector-1 Joint 2
Torque (N.m)	1.637e-10	0	0	-1.637e-10	Pin Connector-1 Joint 2
Shear Force (N)	100	100	-1.9763e-05	0	Pin Connector-1 Joint 3
Axial Force (N)	5.0077e-06	0	0	-5.0077e-06	Pin Connector-1 Joint 3
Bending moment (N.m)	6.7201	-0.06511	-6.7198	0	Pin Connector-1 Joint 3
Torque (N.m)	-1.8551e-10	-0	-0	1.8551e-10	Pin Connector-1 Joint 3
Shear Force (N)	99.998	99.998	-1.9763e-05	0	Pin Connector-1 Joint 4

Copy Tabular Simulation Results to Clipboard

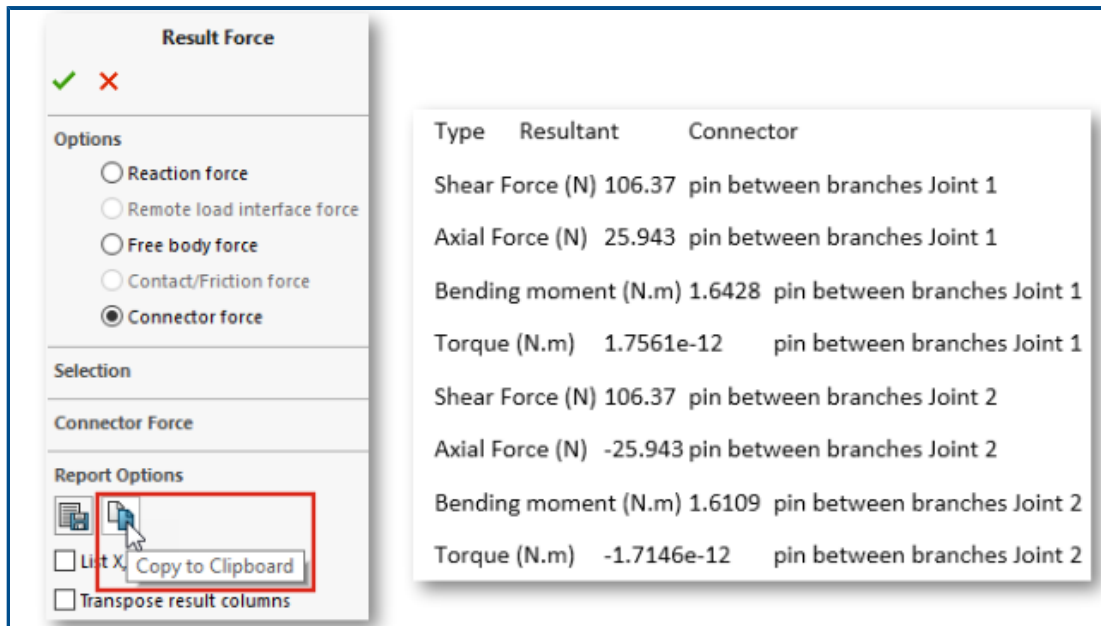

You can copy tabular simulation results displayed inside PropertyManagers to the clipboard and paste the copied data from the clipboard into a Microsoft® Excel® or Word document. You can copy reaction forces, free body forces, contact/friction forces, connector forces, and probed results.

In a PropertyManager that contains simulation results, under **Report Options**, select **Copy to Clipboard** .

## Performance Improvements in SOLIDWORKS Simulation Professional and SOLIDWORKS Simulation Premium

Improvements in contact calculations and multicore meshing make simulations faster.

- Calculation of contact interactions with the **FFEPlus Iterative** solver for linear static studies is faster than previous releases. The overall solution time is improved by using parallel multicore processing to calculate the stiffness for surface-to-surface contact elements. In addition, the transfer of stiffness data to solve the systems of equations is optimized because file-based processing is replaced with function-based processing.
- The Blended Curvature-based mesher supports multicore meshing. There is no limit to the number of physical cores that the Blended Curvature-based mesher can access.

# 15

## SOLIDWORKS Visualize

---

This chapter includes the following topics:

- **Capping Cut Planes**
- **Draco Compression for SOLIDWORKS Visualize GLTF and GLB Exporter**
- **Support for SOLIDWORKS Configurations**
- **Toon Shading**
- **Displacement Mapping**
- **Shaders**
- **User Interface Enhancements for SOLIDWORKS Visualize**
- **Render Layers**
- **Viewport Settings Dialog Box**

	<p><b>Video: What's New in SOLIDWORKS 2021 - Visualize</b></p>
--	--

SOLIDWORKS® Visualize is a separately purchased product that you can use with SOLIDWORKS Standard, SOLIDWORKS Professional, and SOLIDWORKS Premium, or as a completely separate application.

## Capping Cut Planes

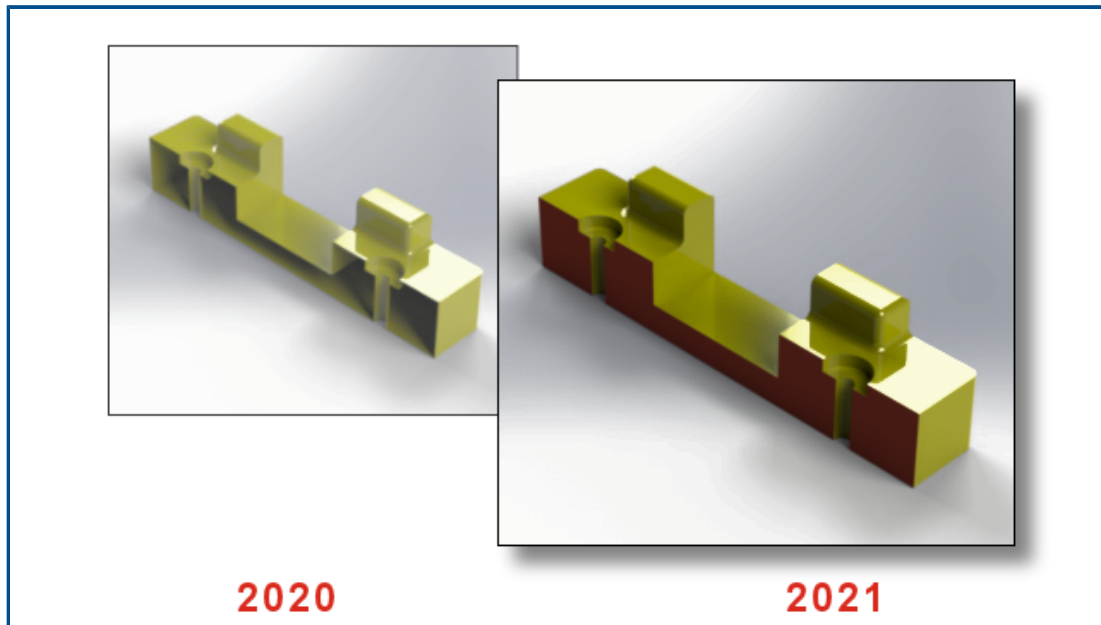

When you create a section view, you can cap the geometry that the cut plane slices.

On the Models  tab, when you add or edit a cut plane, use the following options:

---

<b>Display Cut Plane Caps</b>	Caps the geometry that the cut plane slices.
-------------------------------	--

---

<b>Cap Color</b>	Assigns a color for all caps in the scene.
------------------	--

---

## Draco Compression for SOLIDWORKS Visualize GLTF and GLB Exporter

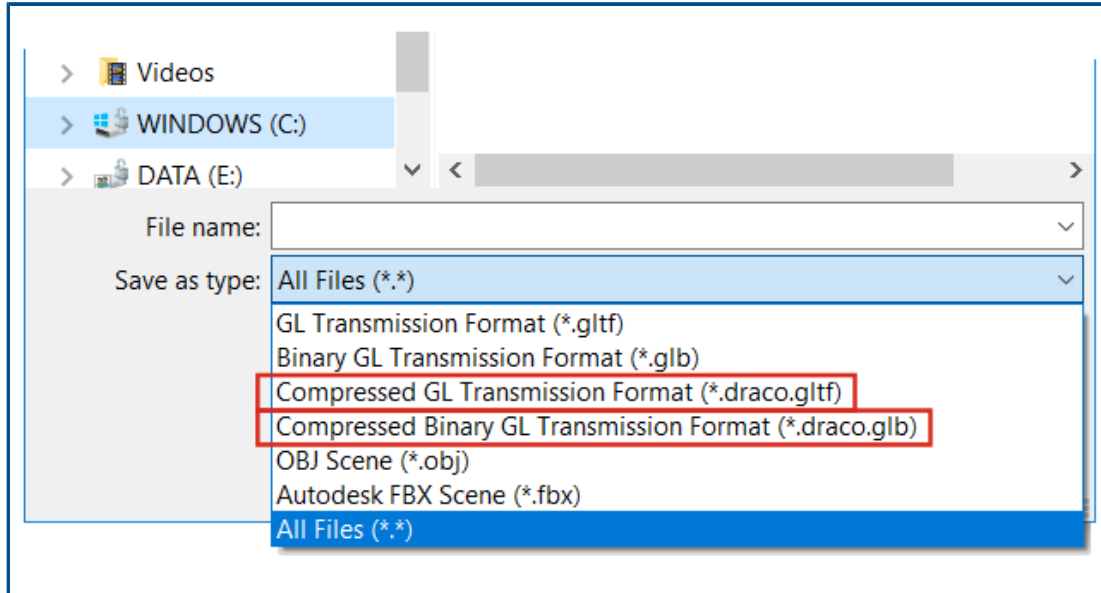

You can use Draco compression when exporting 3D scenes from SOLIDWORKS Visualize to .gltf and .glb files.

3D scenes from SOLIDWORKS Visualize often have large file sizes, which can cause problems in scenarios that require the .gltf or .glb formats, such as augmented reality and web streaming. Draco is the standard compression mechanism for .gltf and .glb files.

You can also export to .gltf and .glb without Draco compression. Not all viewers or external applications can decompress it.

To export to .gltf and .glb files, click **File > Export > Export Project**. In the Export dialog box, for **Save as type**, select one of the following:

- To export with Draco compression:
  - **Compressed GL Transmission Format (\*.draco.gltf)**
  - **Compressed Binary GL Transmission Format (\*.draco.glb)**
- To export without Draco compression:
  - **GL Transmission Format (\*.gltf)**
  - **Binary GL Transmission Format (\*.glb)**

## Support for SOLIDWORKS Configurations

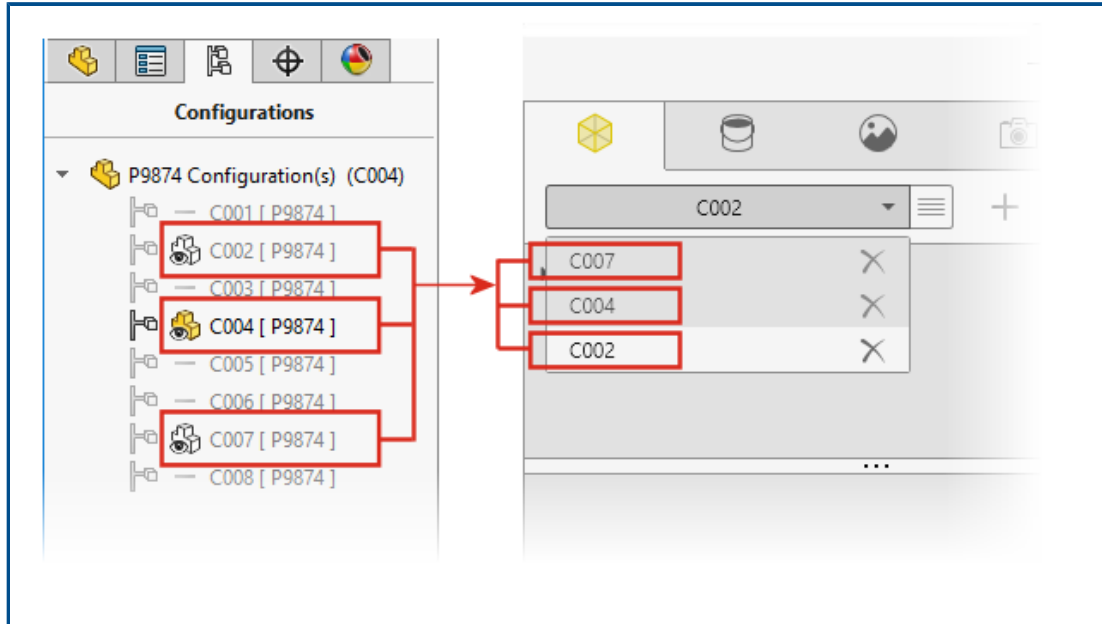

You can specify configurations of a SOLIDWORKS part or assembly model to be available when you open the model in SOLIDWORKS Visualize.

In SOLIDWORKS, you must add the Display Data Mark to the configurations you want to import into SOLIDWORKS Visualize. In the ConfigurationManager, right-click one or more configurations and click **Add Display Data Mark**. Then when you import the model into SOLIDWORKS Visualize, each configuration becomes a Model Set. The Model Set name matches the configuration name.

## Toon Shading

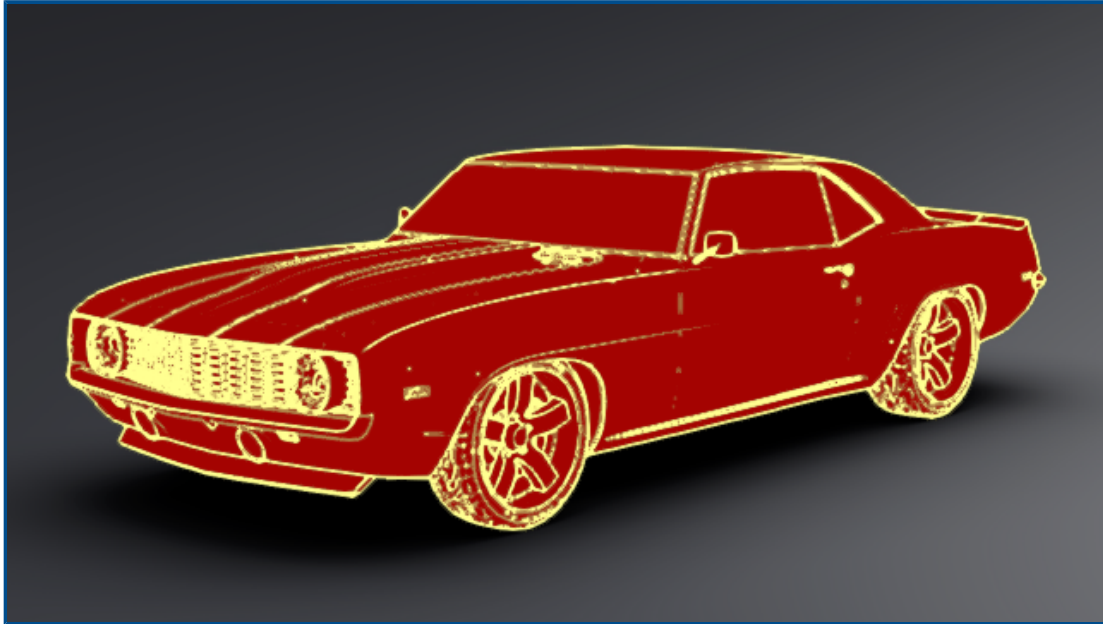

Toon shading mimics the style of a comic book or cartoon and provides a characteristic paper-like texture. Toon shading is available only with Visualize Professional.

### To add Toon shading:

1. In the Palette, on the Cameras tab, select the Filters subtab.  
Because Toon shading is added as a camera filter, your primary appearance assignments remain unchanged.
2. Under **Toon**, select **Enable Toon** and specify parameters:

---

<b>Toon Presets</b>	Provides a list of predefined toon profiles that you can select. <b>Black Edges</b> <b>White on Black</b> <b>Black on White</b> <b>Ambient Occlusion</b> <b>Custom</b>
<hr/>	
<b>Edge Color</b>	Changes the color of the outlines. Click the color box to open the Color Picker dialog box.

---



**Shading Style**

Select a style:

**Normal****Toon Shaded****Toon Detail****Color Override****Plain Shaded**

You can save the camera .svcm file, which contains the Toon shading parameters, and use it in other Visualize projects or share it with other users.

## Displacement Mapping

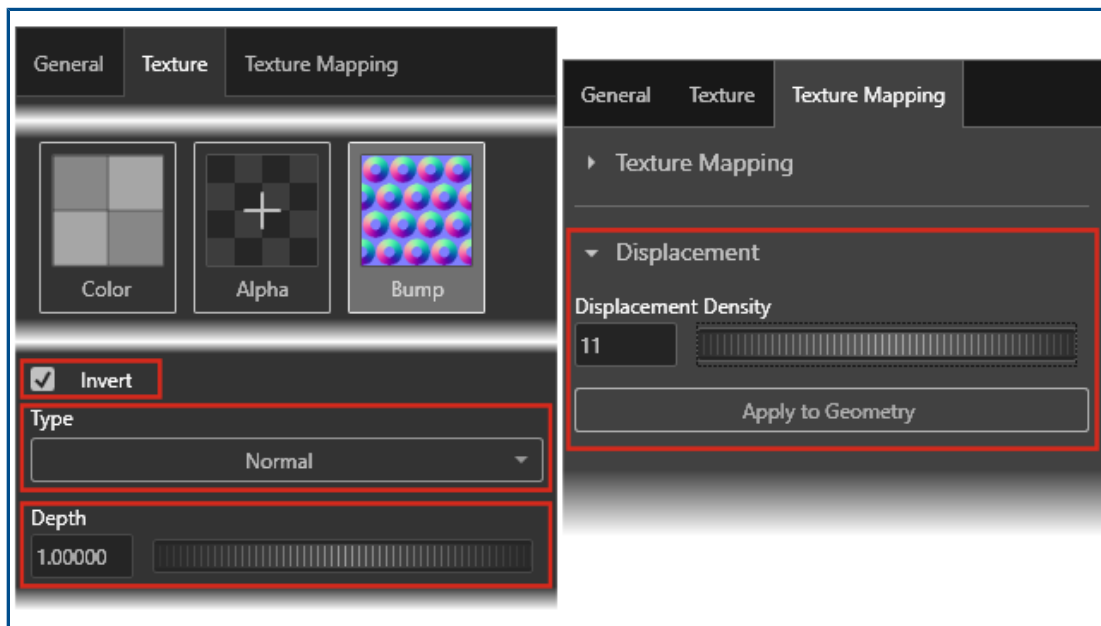

New options in the Appearances  tab provide more overall control of displacements.

- New displacement options include:
  - **Depth.** Controls how high the bumps display on the surface. Increase the depth to make the surface bumpier. Decrease the depth to make the surface smoother.
  - **Displacement Density.** Specifies the maximum length of the edge of a subtriangle. Higher values result in smaller triangles and better quality.
- The **Type** list replaces check boxes for selecting a map type. You can select:
  - **Bump**
  - **Normal**
  - **Displacement**
- Because multiple types of bump maps are available, **Invert Bump** is renamed **Invert**.

## Shaders

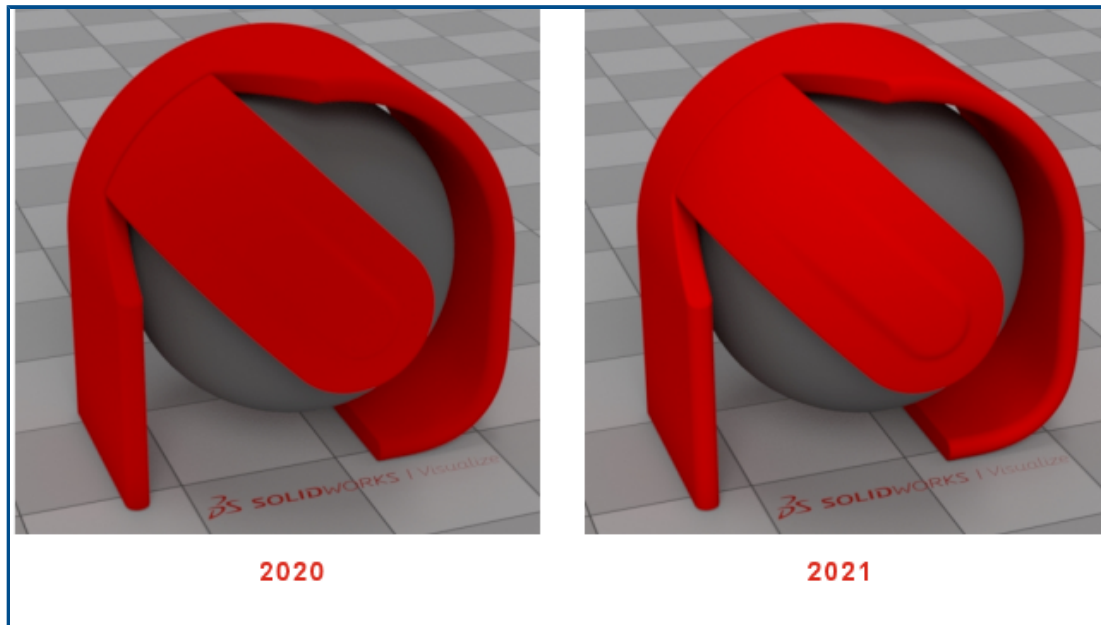

SOLIDWORKS Visualize uses a rendering technique that adds light to most appearance types. This makes it easier to generate first-class commercial looks without violating the photo-realistic principles of physically based appearances.

In previous versions, SOLIDWORKS Visualize appearances offered a high level of photo-realism, but you had to use excessive light and camera filter adjustments to generate sufficient brightness and saturation.

## User Interface Enhancements for SOLIDWORKS Visualize

User interface enhancements for SOLIDWORKS Visualize include improvements for animations, properties, decals, and appearances.

- **Animations.** You can drag an existing animation from the timeline animation list to another model, part, or group, to apply an identical animation without having to recreate it. You can drag the animation only onto the same type of object (model, part, or group) that the animation belongs to.
- **Properties.** You can copy and paste settings across Camera and Light objects. Right-click an object and click **Copy Settings**. Then right-click another object and click **Paste Settings**. Previously, you could only do this for Environment and Sunlight objects.
- **Decals.** Decals created from an image sequence or video have dynamic thumbnails in the palette view. Hover the pointer over the decal thumbnail in the Appearances tab. The thumbnail displays a preview of the video decal.
- **Appearances.** You can double-click a part in the viewport to select its appearance in the Appearance tree, where you can edit it.

## Render Layers

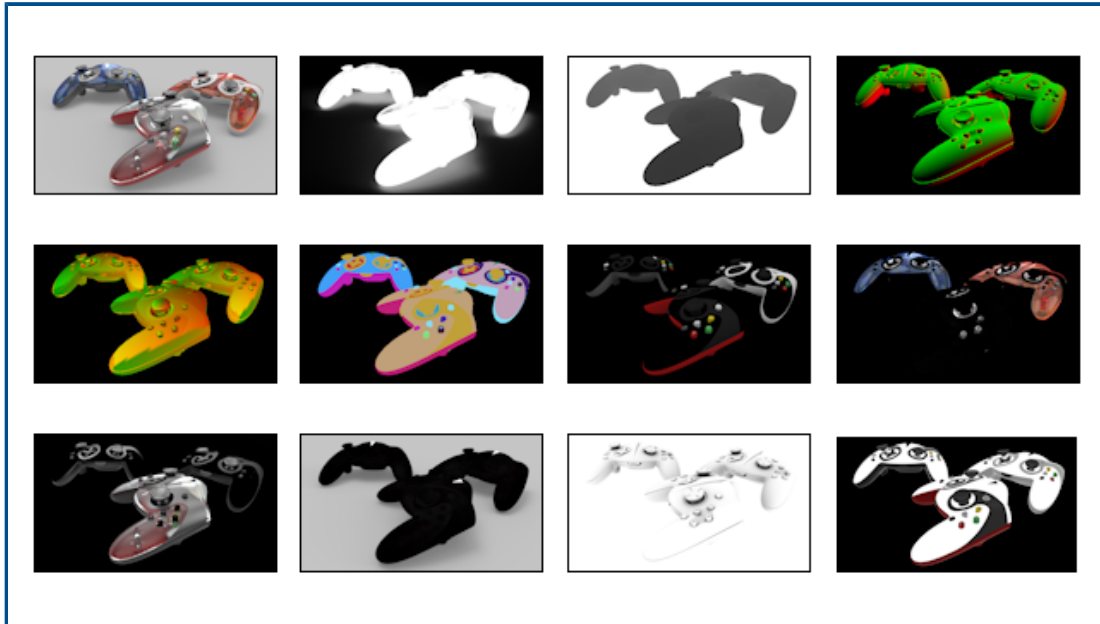

In the Output Tools dialog box, **Render Layers** replaces **Render Output Passes** for generating specialized output layers that you can use in post-processing software. **Render Layers**, which uses Iray's compositing elements, provides massively improved performance by rendering simultaneously rather than sequentially.

The rendered layers created by **Render Layers** align more closely with industry standard render passes known as Arbitrary Output Variables (AOVs).

**Render Layers** is available in SOLIDWORKS Visualize Professional.

**Limitation:** **Render Layers** does not work with **Toon**. If **Toon** is enabled in Camera, the rendered layers are not displayed in the viewport and are not available for final renders in **Output Tools**.

### To render layers:

1. In SOLIDWORKS Visualize Professional, open a project and click **Output Tools**  (main toolbar) or **Tools > Render**.
2. In the Output Tools dialog box, on the Render, Animation, Turntable, or Sun Study tab, in **Render Layers**, select layers to render.
3. Click **Start Render**.

The Render viewport opens. When the render is complete, a list of the image files for each rendered layer appears.

4. To view a layer image, click its file name in the list.

Different render modes (**Preview**, **Fast**, **Accurate**) support different sets of layers to render.

Layer	Preview	Fast	Accurate	Description
<b>Beauty</b>	✓	✓	✓	Contains the rendered image with all contributions.
<b>Alpha</b>		✓	✓	Contains the alpha channel (transparency) based on primary visibility.
<b>Depth</b>	✓	✓	✓	Contains the depth of the hit point along the (negative) Z-coordinate in camera space. The depth is zero at the camera position (black) and extends in a positive direction into the scene (brighter, white).
<b>Normal</b>		✓	✓	Contains the surface shading normal in camera space.
<b>UVWs</b>		✓	✓	Contains the texture (or UVW) coordinate at the hit point.
<b>Clown</b>	✓	✓	✓	Contains the ID for the scene element at the hit point.
<b>Diffuse</b>		✓	✓	Contains all light transport paths that are diffuse at the first bounce.
<b>Specular</b>	✓	✓	✓	Contains all light transport paths that are specular at the first bounce.
<b>Glossy</b>	✓	✓	✓	Contains all light transport paths that are glossy at the first bounce.
<b>Emission</b>		✓	✓	Contains the emission contribution from directly visible light sources and emitting surfaces.
<b>Shadow</b>		✓		Contains the shadow in the scene. More precisely, the layer contains the light contributions that are missing at a certain point because it is blocked by an object (the shadow caster).
<b>Ambient Occlusion</b>	✓	✓		Contains the ambient occlusion in the scene in the range from 0 (fully occluded) to 1 (not occluded).

Layer	Preview	Fast	Accurate	Description
<b>Albedo</b>		✓	✓	Contains approximate color weights for the constituent bidirectional scattering distribution functions (BSDFs) of the material at the first hit. This value generally reflects textures (bitmap and procedural) used to color material components.

## Viewport Settings Dialog Box

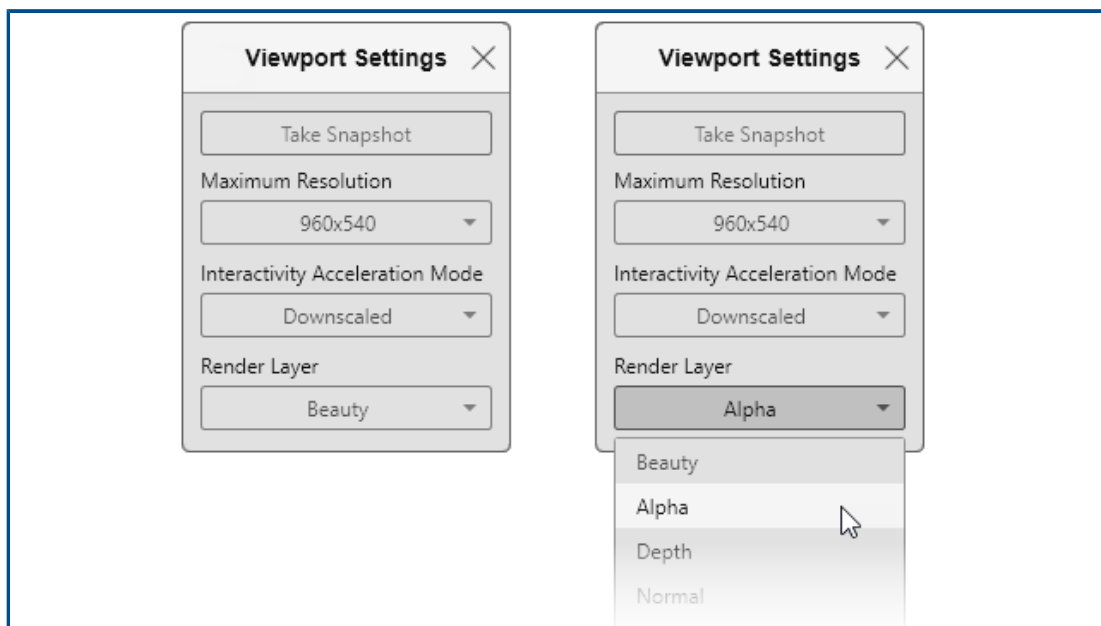

The Viewport Settings dialog box provides quick access directly in the viewport to some frequently used settings.

To open the Viewport Settings dialog box, click **View > Show Viewport Settings**. The dialog box remains available in the viewport until you close it. It provides access to these commands:

<b>Take Snapshot</b>	Captures an image from the current viewport and saves it using the file type specified in <b>Tools &gt; Render &gt; Snapshot &gt; Image Format</b> and the resolution specified below. The image file is saved in the Images library folder, typically <code>\Documents\SOLIDWORKS Visualize Content\Images</code> .
<b>Maximum Resolution</b>	Specifies the resolution (in pixels, width x height) of the 3D Viewport and output snapshots. This option is also available in <b>Tools &gt; Options &gt; 3D Viewport</b> .

**Interactivity  
Acceleration Mode**

**Steady**  
**Blended**

No accelerating technique is used.

Causes the scene to automatically switch to **Preview** mode whenever you do anything – such as moving the camera or model, playing an animation, dragging a material, or clicking the mouse in the viewport.

When you stop clicking or moving the mouse, the scene blends into the raytrace mode you have selected (**Fast** or **Accurate**).

**Downscaled** Reduces the viewport size during interaction. This option improves interactivity but with lower interactive image quality.

These options are also available in **Tools > Options > 3D Viewport**.

---

**Render Layer**

(Available only for **Fast** and **Accurate** render modes.) Displays the selected render layer in the viewport. This lets you preview the available render layers to help you decide which ones to include in your final render.

---

# 16

## SOLIDWORKS CAM

---

This chapter includes the following topics:

- **Additional Stock Types Available in Stock Manager**
- **Rebuild Data When Stock Parameters Are Modified**
- **End Conditions for Part Perimeter Feature**
- **Modify Path to Post Processors in the Technology Database**
- **Defining Peck Amounts for Point-to-Point Operations**
- **Supported Platforms for SOLIDWORKS CAM**

	<p><b>Video: What's New in SOLIDWORKS 2021 - CAM</b></p>
--	--

SOLIDWORKS CAM is offered in two versions. SOLIDWORKS CAM Standard is included with any SOLIDWORKS license that has SOLIDWORKS Subscription Service.

SOLIDWORKS CAM Professional is available as a separately purchased product that you can use with SOLIDWORKS Standard, SOLIDWORKS Professional, and SOLIDWORKS Premium.

## Additional Stock Types Available in Stock Manager

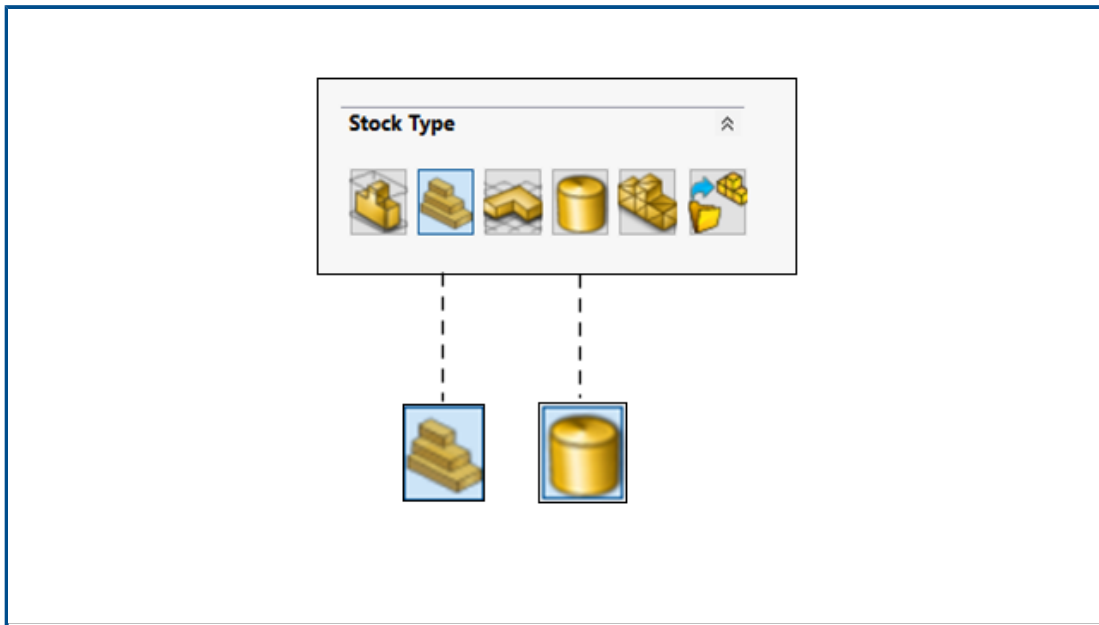

The Stock Manager lets you define **Bounding Box** and **Cylindrical Stock** for mill parts and assemblies.

You can use the **Bounding Box** to align the stock. You can assign the premachined **Bounding Box** to a unique material group in the Technology Database.

You can define **Cylindrical Stock** parameters such as the center axis, origin, diameter, and length of the cylinder, and offsets.



## Rebuild Data When Stock Parameters Are Modified

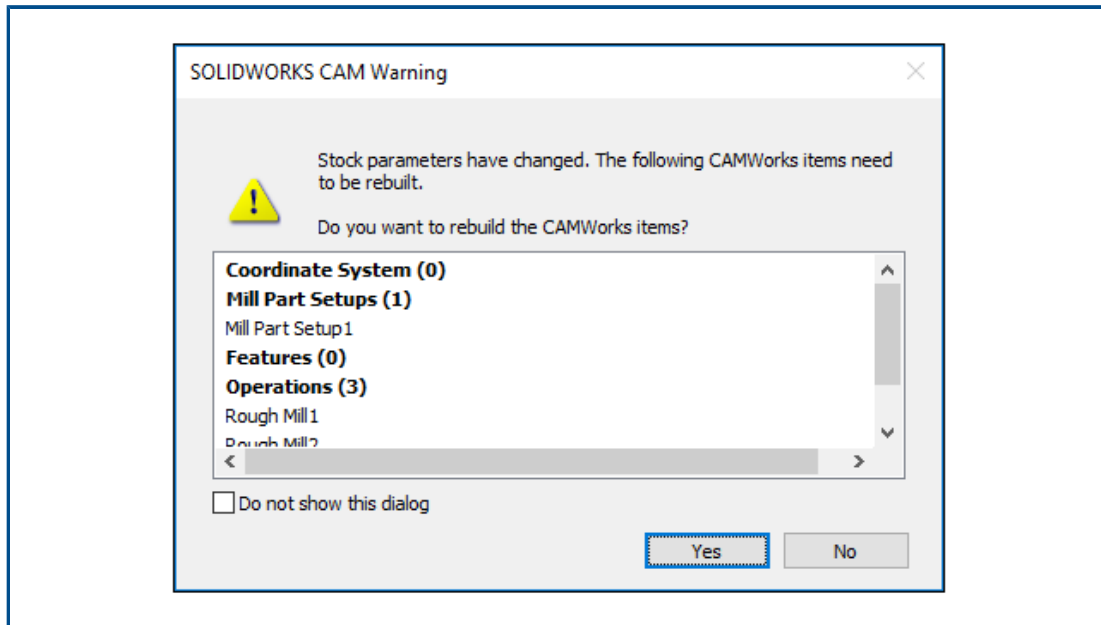

In the **Mill** module, when you modify stock parameters after generating features, options, or toolpaths, a warning lets you rebuild data for entities affected by the change. These entities may include coordinate systems, mill part setups, features, and operations.

If you decide not to rebuild, exclamation marks appear over the entities' icons in the Feature tree and Operations tree. You can display the warning by right-clicking the entities affected and selecting **What's Wrong** in the context menu so you can rebuild the CAM data.

The warning message is enabled by default in **Tools > SOLIDWORKS CAM > Options**. To change the setting, click the Update tab and under **Prompt to Rebuild**, clear **On stock parameters notification**.

## End Conditions for Part Perimeter Feature

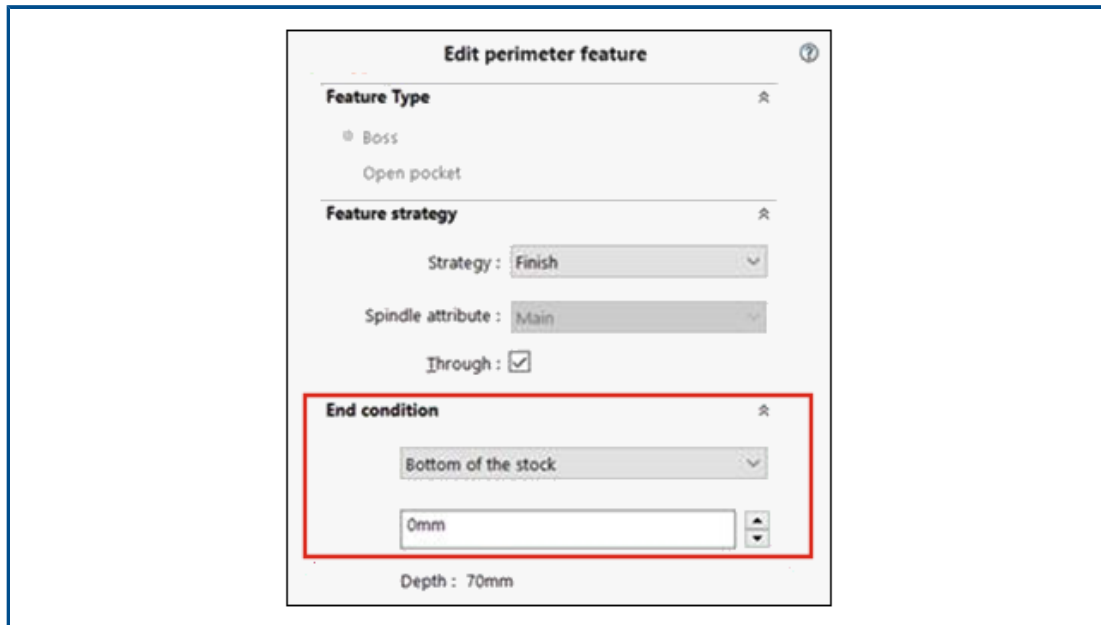

You can store end condition settings for the part perimeter feature in the Technology Database. This data is helpful in automating and maintaining consistency between parts that are similar when programming.

## Modify Path to Post Processors in the Technology Database

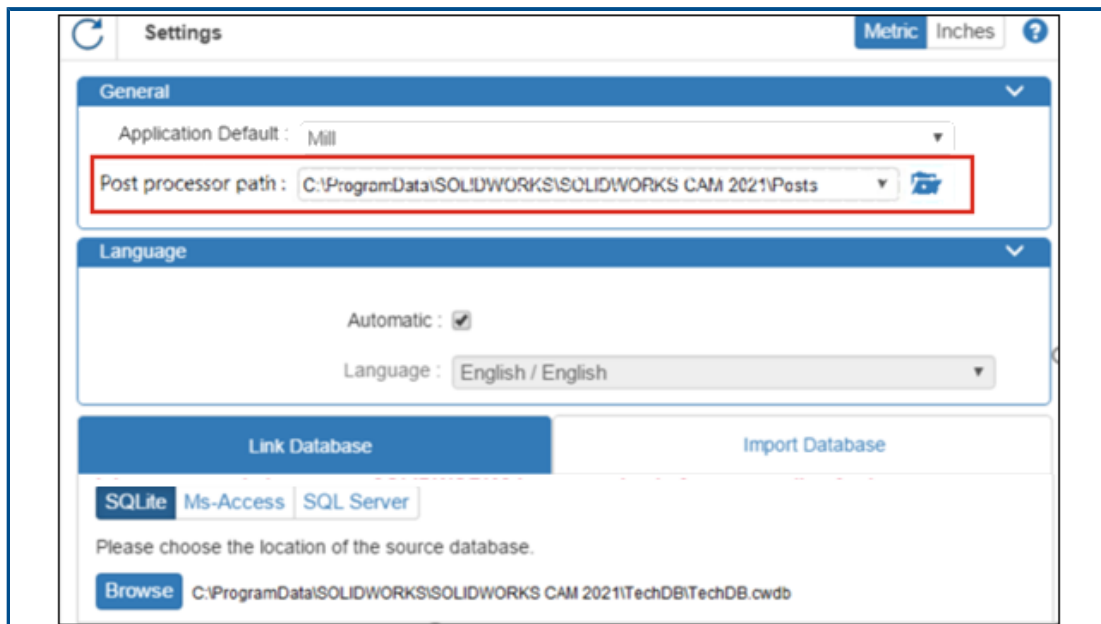

In the Settings tab of the Technology Database, you can specify a folder location for post processors associated with a Mill or Turning machine.

You can then select post processors in the General tab of the Mill machine or Turning machine.

## Defining Peck Amounts for Point-to-Point Operations

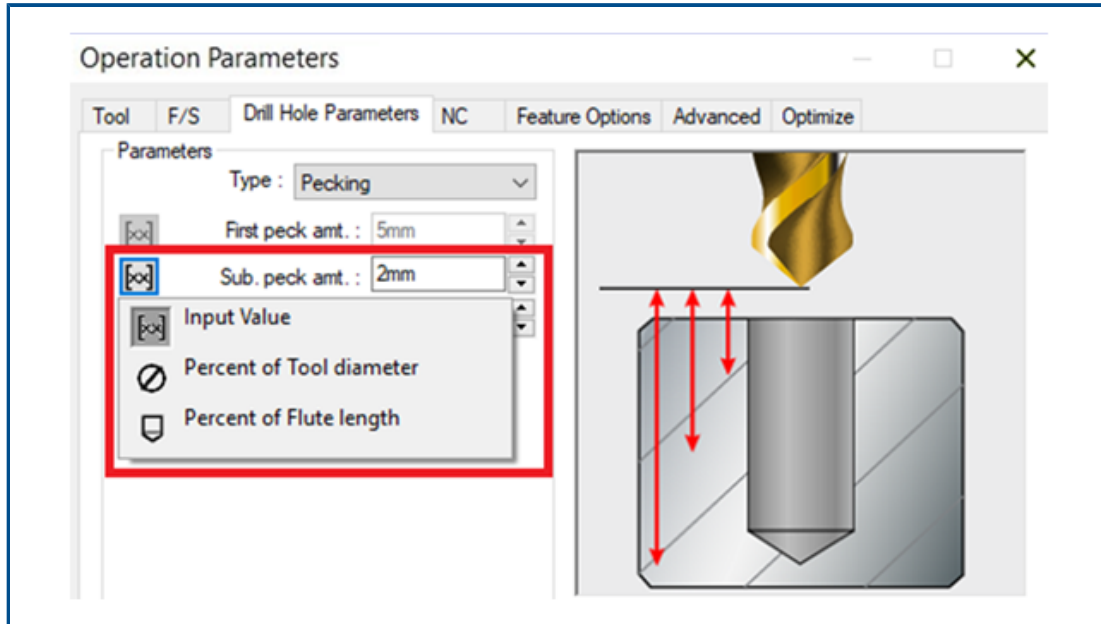

You can define peck amounts for point-to-point operations as a percentage of the diameter or the flute length of a tool, as well as an absolute value.

## Supported Platforms for SOLIDWORKS CAM

SOLIDWORKS® CAM 2021 Beta supports the 64-bit version of SOLIDWORKS 2020, running on a 64-bit version of Windows® 10, Windows 8.1, or Windows 7 (SP1 or higher).

# 17

## SOLIDWORKS Composer

---

This chapter includes the following topics:

- **Controlling the Display of Hidden Edges**
- **Highlighting of Invisible Actors**
- **Delete Empty Groups at Import**
- **Loading Improvements**
- **Saving Multiple Configurations to SOLIDWORKS Composer Files**
- **Sharing (Default) Document Properties**
- **Other SOLIDWORKS Composer Enhancements**

SOLIDWORKS® Composer™ software streamlines the creation of 2D and 3D graphical contents for product communication and technical illustrations.

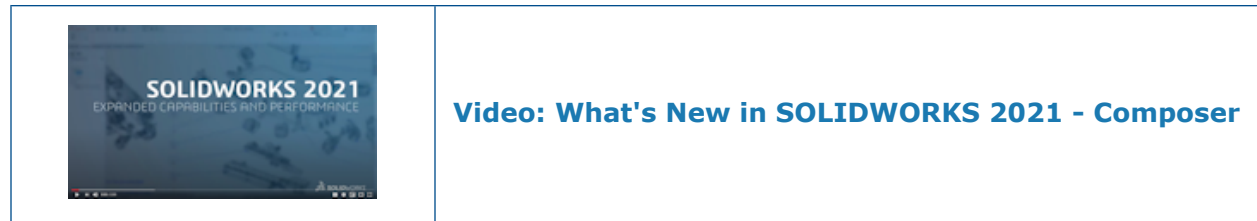

## Video: What's New in SOLIDWORKS 2021 - Composer

## Controlling the Display of Hidden Edges

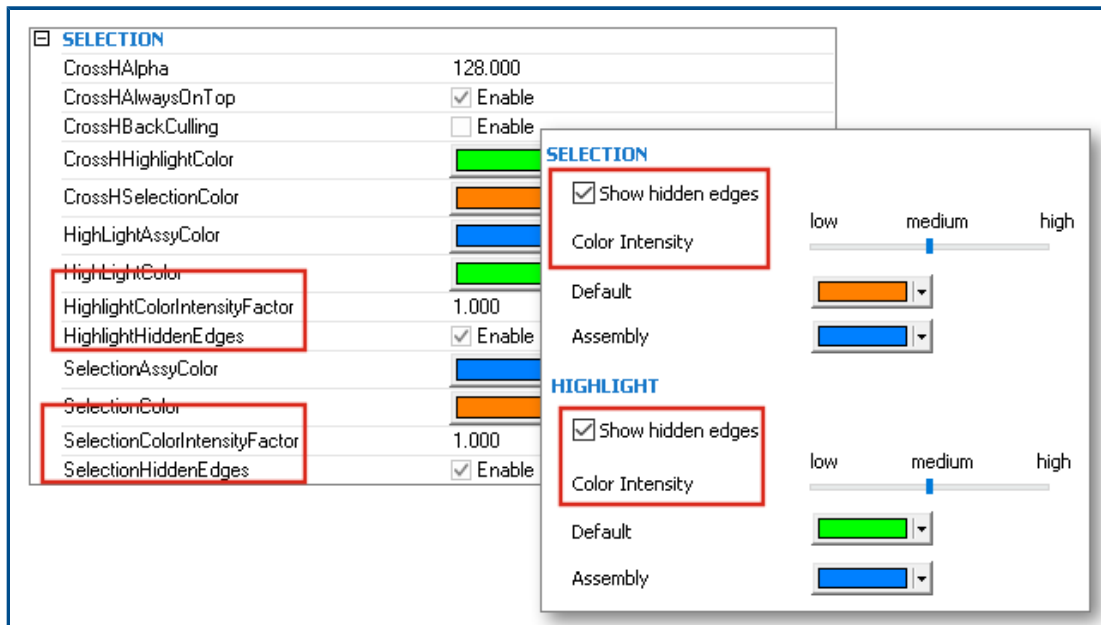

You can control the visibility of hidden edges when you select or highlight elements. You can define the color and intensity used to display hidden edges.

Available in SOLIDWORKS Composer, SOLIDWORKS Composer Player, and SOLIDWORKS Composer Sync.

In the **(Default) Document Properties > Selection** page, the **Show hidden edges** check box, and the **Color Intensity** slider are added in the **Selection** and **Highlight** sections. See *Managing (Default) Document Properties > Selection, Composer Player > Managing Document Properties > Selection, or Sync > Managing Default Document Properties > Selection* in *Composer Help*.

In the **Document Properties > Advanced page**, four corresponding properties are available in the **Selection** category. See *Managing (Default) Document Properties > Advanced Properties, Composer Player > Managing Document Properties > Advanced Properties, or Sync > Managing Default Document Properties > Advanced Properties* in *Composer Help*.

These new properties replace the **Show hidden edges** option and the **Intensity** slider that were available in the **Application Preferences > Selection** page in previous versions of SOLIDWORKS Composer.

## Highlighting of Invisible Actors

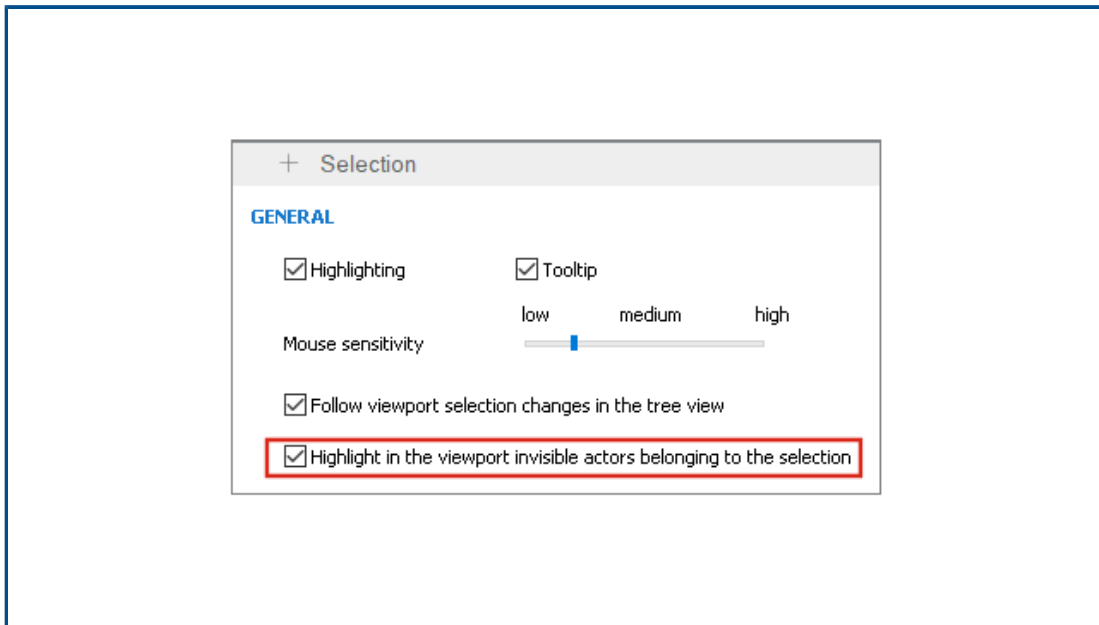

Invisible actors have their visibility turned off. You can specify to highlight them in the viewport when you select them in the Assembly tree or elsewhere.

Available in SOLIDWORKS Composer and SOLIDWORKS Composer Player.

See *Customizing Application Preferences > Selection* or *Composer Player > Customizing Application Preferences > Selection* in *Composer Help*.

## Delete Empty Groups at Import

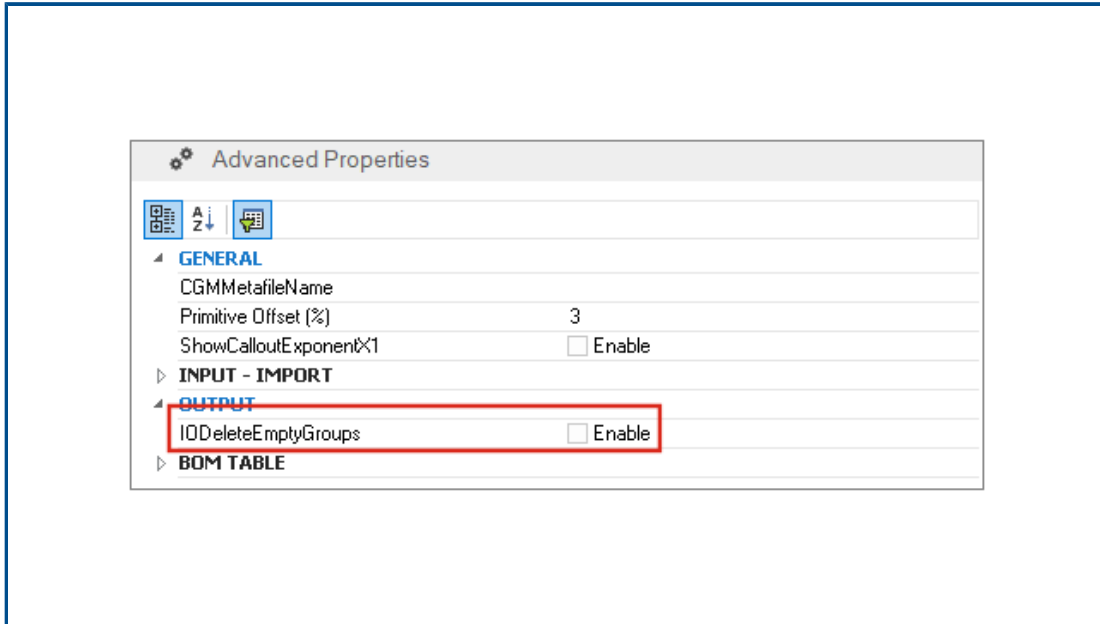

You can use the **IODeleteEmptyGroups** advanced document property to specify that groups that would be empty in the assembly tree after import are removed during the import process.

Available in SOLIDWORKS Composer and SOLIDWORKS Composer Sync.

See *Managing (Default) Document Properties > Advanced Properties* or *Sync > Managing Default Document Properties > Advanced Properties* in *Composer Help*.

## Loading Improvements

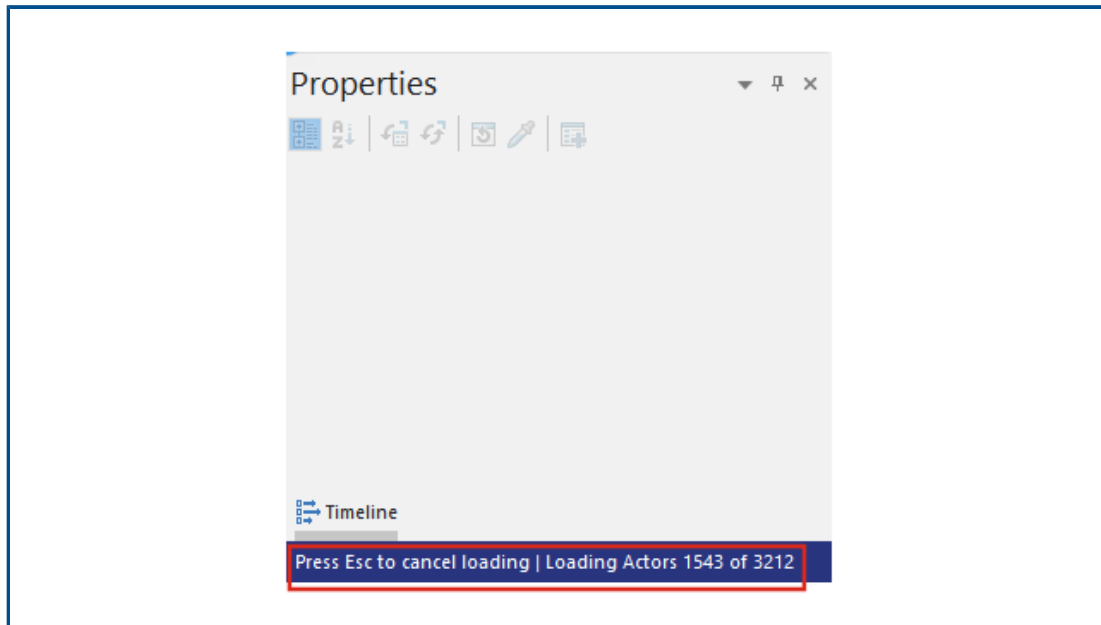

The loading process is improved for Composer documents such as .smg, .smgXML, .smgProj, and fully shattered files.

Available in SOLIDWORKS Composer.

- The loading status appears in the left-hand side of the status bar.
- During the loading process, you can press **Escape** to cancel the operation. This does not affect already-opened files.

See *Importing and Opening Files > Importing and Opening Files* in *Composer Help*.



## Saving Multiple Configurations to SOLIDWORKS Composer Files

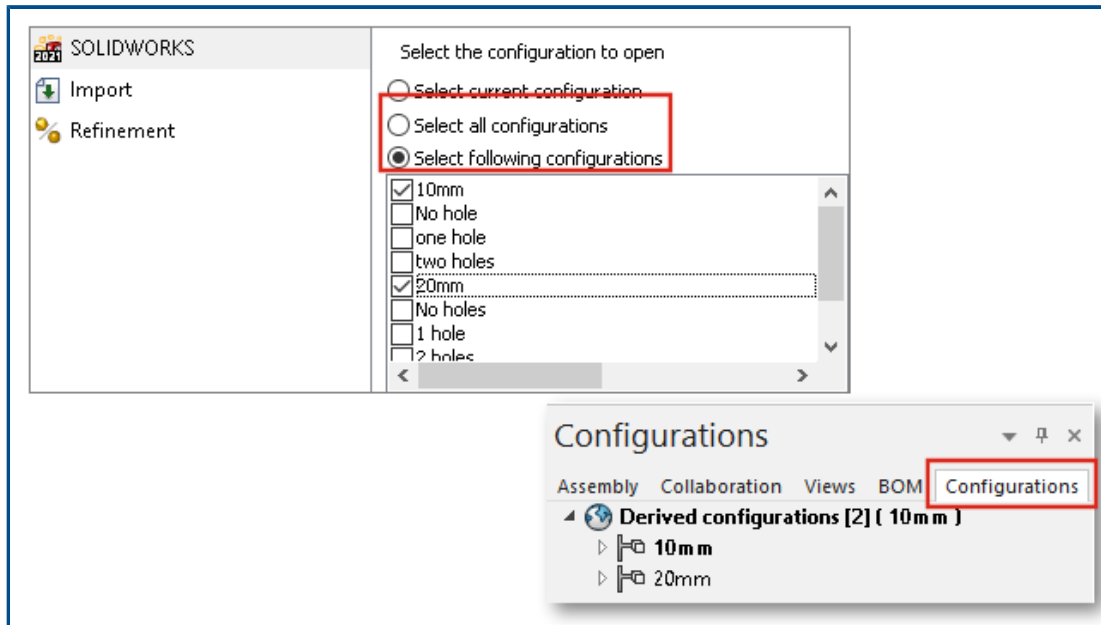

You can save multiple or all configurations from SOLIDWORKS files to Composer files.

Available in SOLIDWORKS Composer.

If a SOLIDWORKS part or assembly file has multiple configurations, when you save the file as a Composer file, you can choose which configurations to save with the Composer file. See *Managing (Default) Document Properties > Input* in *Composer Help*.

## Sharing (Default) Document Properties

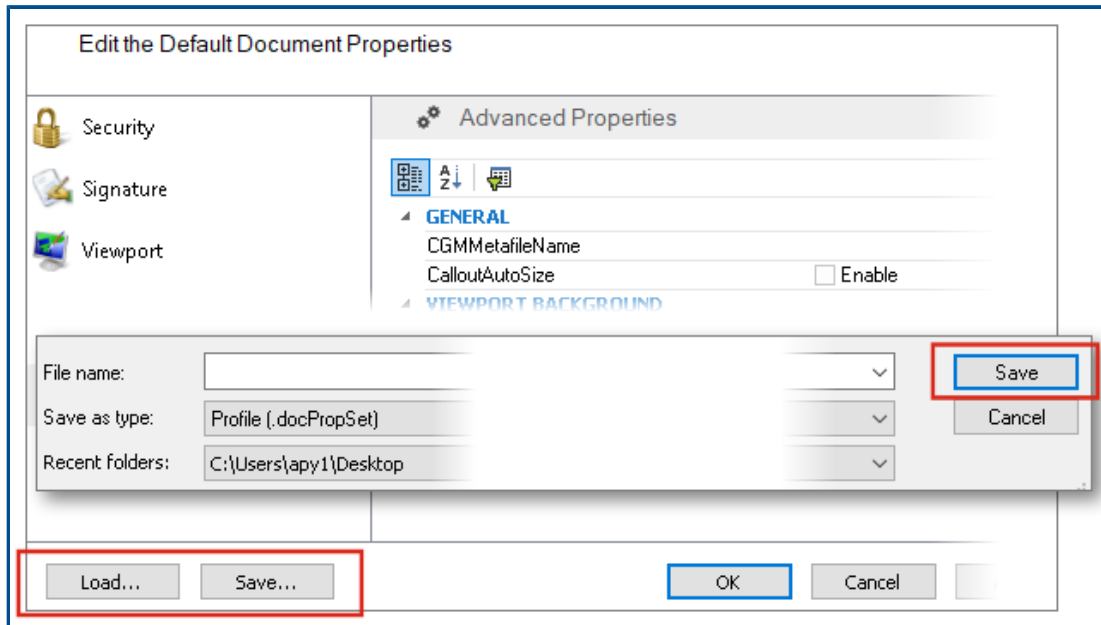

You can save (default) document properties settings to a file that you can reuse as a template. Your colleagues can load this file in Composer to use the same (default) document properties.

Available in SOLIDWORKS Composer.

This makes it easy to globally harmonize the document properties for all project stakeholders. See *Managing (Default) Document Properties > Sharing (Default) Document Properties Across Teams* in *Composer Help*.

## Other SOLIDWORKS Composer Enhancements

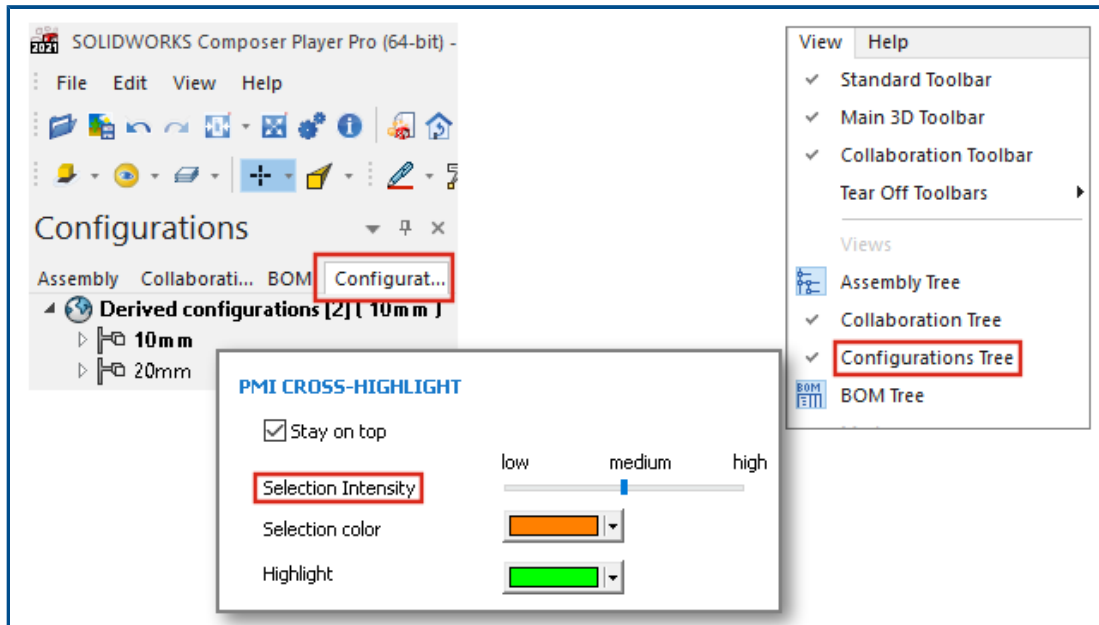

SOLIDWORKS Composer products have additional user interface and import improvements.

- SOLIDWORKS Composer and SOLIDWORKS Composer Sync support the following higher versions of import formats:
  - ACIS up to R2020 1.0
  - Pro/E Creo 1.0 to 6.0
  - SOLIDWORKS 2006 to 2021
- In SOLIDWORKS Composer, SOLIDWORKS Composer Player, and SOLIDWORKS Composer Sync, the **Selection Opacity** property ( **(Default) Document Properties > Selection > PMI Cross-Highlight** ) is renamed to **Selection Intensity**. The behavior of this property remains unchanged.
- In SOLIDWORKS Composer, SOLIDWORKS Composer Player, and SOLIDWORKS Composer Sync, performance is improved when loading and saving Composer documents (\*.smg, \*.smgXml, \*.smgProj, \*.smgSce).
- In SOLIDWORKS Composer Player, you can view the configurations in Composer files in the Configurations pane. You can also control the visibility of the Configurations pane from **View > Configurations Tree**.
- The user interface in SOLIDWORKS Composer Player is modernized. You can dock, undock, move, resize, and auto hide panes. See *Composer Player > Interface Concepts* in *Composer Help*.

# 18

## SOLIDWORKS Electrical

---

This chapter includes the following topics:

- **Symbols for Terminal Strips**
- **Excluding a Manufacturer Part from a BOM**
- **Add-In for Excel Automation**
- **Managing Wires**
- **Archiver and Scheduling Process**
- **SOLIDWORKS Electrical Viewer**
- **Creating Multiple Drawings Simultaneously**
- **Generating Separate Routing Assemblies of Cables**
- **Using Splines in Routings**

	<p><b>Video: What's New in SOLIDWORKS Electrical - 2021</b></p>
--	---

SOLIDWORKS® Electrical is a separately purchased product.

## Symbols for Terminal Strips

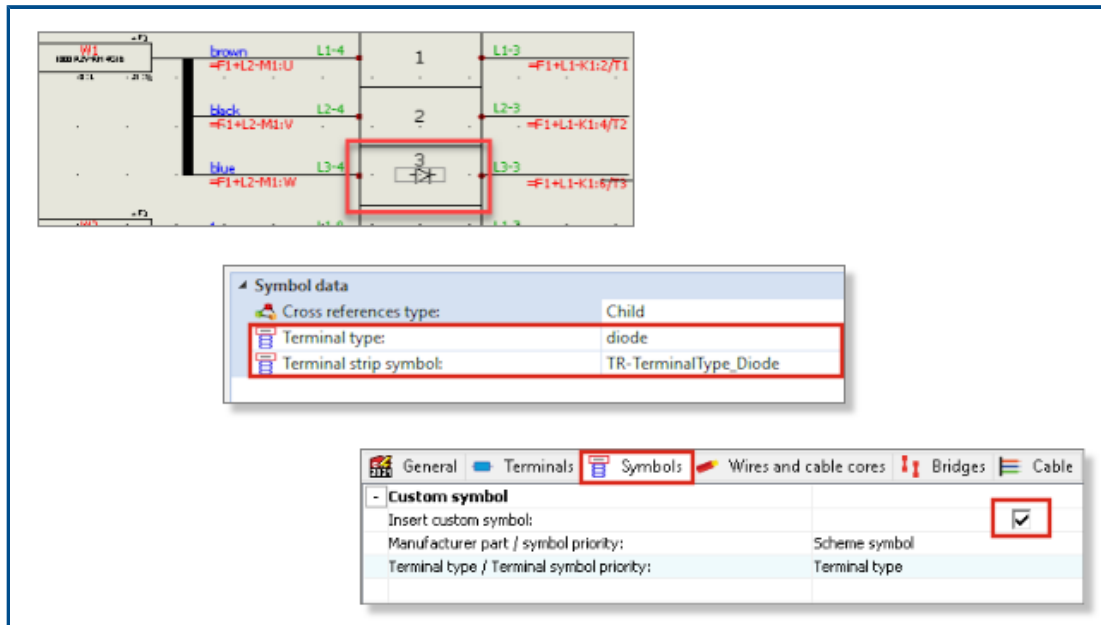



You can associate a specific terminal symbol used in a terminal drawing either to a manufacturer part or to a terminal symbol used in a schematic. This allows you to have a different representation of the terminals in the terminal strip drawing.

### Associating a Terminal Symbol with a Manufacturer Part

You can associate a terminal strip symbol and a terminal type with a manufacturer part stored in the Manager.

#### To define a Terminal type and a Terminal strip symbol in a manufacturer part properties:



1. In the **Library** tab, click **Manufacturer part manager** .
2. Select the manufacturer part you want to edit.
3. Click **Properties** .
4. Under **Illustration**, specify the required values for **Terminal type** and **Terminal strip symbol**.

These values propagate to all the new components that use this manufacturer part in the project.

## Associating a Terminal Symbol with a Schematic Terminal Symbol

You can associate a terminal strip symbol and a terminal type with a terminal symbol stored in the Symbols Manager.

### To define a Terminal type and a Terminal strip symbol in the properties of a schematic terminal symbol:

1. In the **Library** tab, click **Symbols manager** .
2. Select the symbol you want to edit.
3. Click **Properties** .
4. Under **Characteristics**, specify the required values for **Terminal type** and **Terminal strip symbol**.

These values propagate to all new components that use this symbol in the project.

## Using Specific Symbols in Configurations of Terminal Strip Drawings

To use specific symbols in terminal strip drawings, in the **Terminal Strip Drawing** configuration, you must activate **Insert custom symbol** and define its parameters.

This feature is not applicable in DIN configurations.

### To update the configuration of terminal strip drawings:

1. In the **Documents** tab, right-click the Project and select **Configurations > Terminal strip drawing**.
2. Select the configuration file and click .
3. In the **Symbols** tab, select **Insert custom symbol**.
4. Define in a first step the parameters for **Priority - Terminal type / Terminal symbol** and in a second step the parameters for **Priority - Manufacturer part / symbol**.

The changes will be applied for the next update of the terminal strip drawings.

## Excluding a Manufacturer Part from a BOM

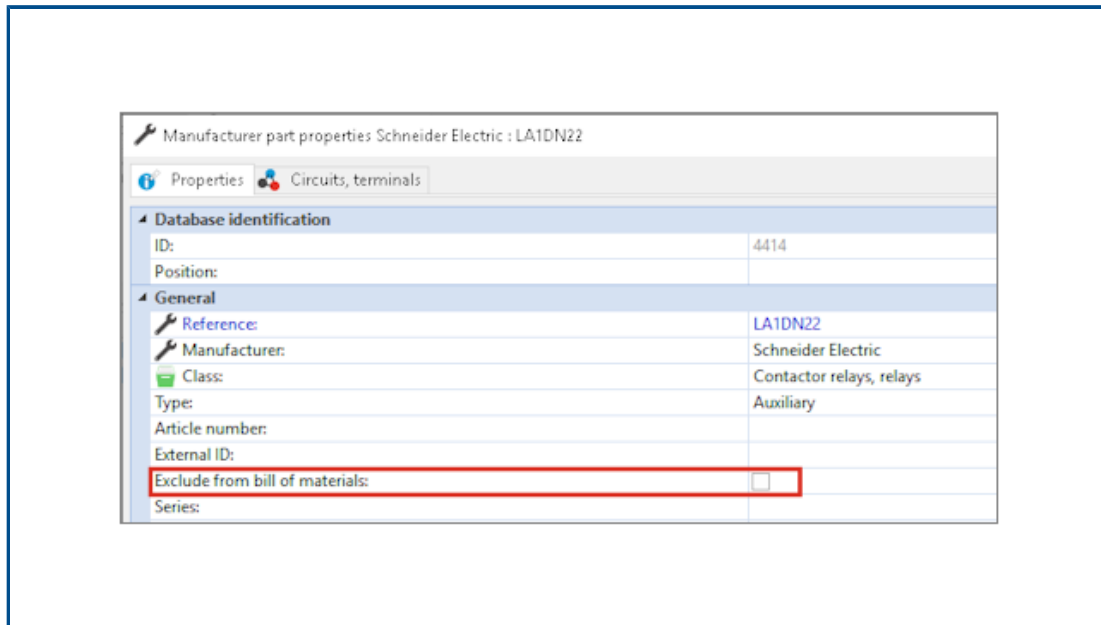



You can use the **Exclude from bill of materials** property in the **Manufacturer part properties** dialog box to show or hide components in a BOM. The property propagates into assemblies and 3D parts.

You can use a filter in the report configuration to hide or show these components.

### Excluding from BOM - Manufacturer Part Properties in the Manager

You can exclude a manufacturer part from the BOM by selecting the **Exclude from bill of material** parameter in the properties of the manufacturer part.

**To exclude manufacturer parts from BOMs in the Manufacturer parts manager:**

1. In the **Library** tab, click **Manufacturer part manager** .
2. Select the manufacturer part to edit.
3. Click **Properties** .
4. Select **Exclude from bill of material**.

### Excluding from BOM - Manufacturer Part Properties in the Project

You can exclude a manufacturer part from a BOM by selecting **Exclude from bill of material** in the properties of the manufacturer part.

**To exclude manufacturer parts from BOMs in the project:**

1. In the graphical area, right-click a symbol and select **Symbol properties** or **Component properties**.
2. On the **Manufacturer part and circuits** tab, click **Properties** .

3. Select **Exclude from bill of material**.



This property propagates only to the manufacturer part associated with the symbol. It does not modify the properties of the manufacturer parts stored in the Manager.

### Excluding from BOM - Using Filter in Report

When you access BOMs in the **Report manager**, a filter lets you hide references tagged **Exclude from BOM**.

You can use a predefined report. To hide the references tagged **Exclude from BOM**, you must select a filter.

**To generate the BOM using the filter:**

1. Click **Report manager**  in the **Project** tab.
2. Select **Bill Of Materials with electrical assemblies sorted by Mark with file number** report.
3. In **Filter description**, select **Display only manufacturer parts which have option Exclude from bill of materials unchecked**.
4. Click **Generate drawings** .

You can also create your report using a condition with the **Exclude from BOM** parameter in the query or a filter.

### Add-In for Excel Automation

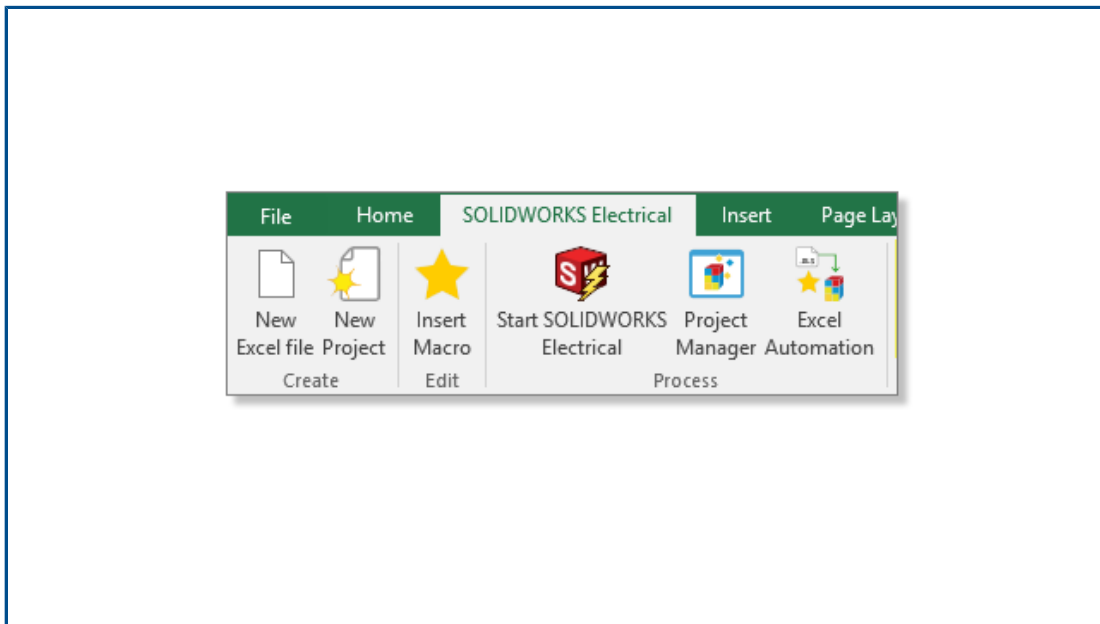



You can install an Excel® add-in that helps create data for the **Excel Automation** feature (requires Excel 64-bit edition).

To install this add-in, from SOLIDWORKS Electrical Schematic, click  and select **Install Excel add-in**.

If the installation does not start automatically, in the dialog box, select `EwExcelAddIn.vsto`.

## Managing Wires

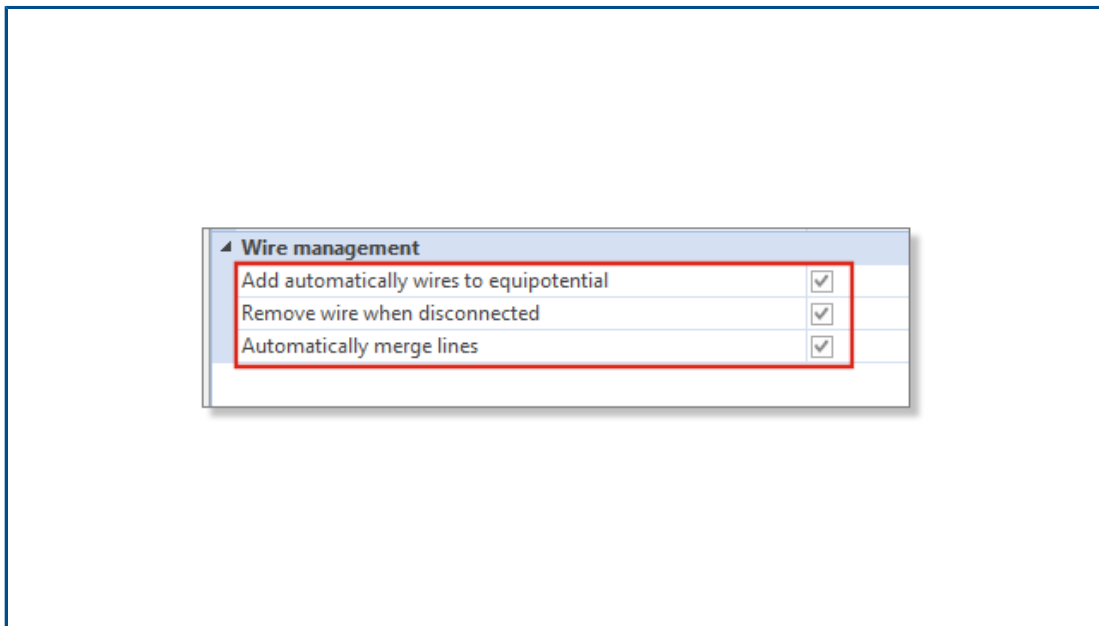

You have more options to manage wires in the project.

These options are available in the **General** tab of the project configuration.

You can:

- Draw lines without wires (equipotentials).
- Remove the wire when you disconnect it from a symbol.
- Merge the wires when you delete a connected symbol.

To process wires in legacy projects, select all these options.

## Archiver and Scheduling Process

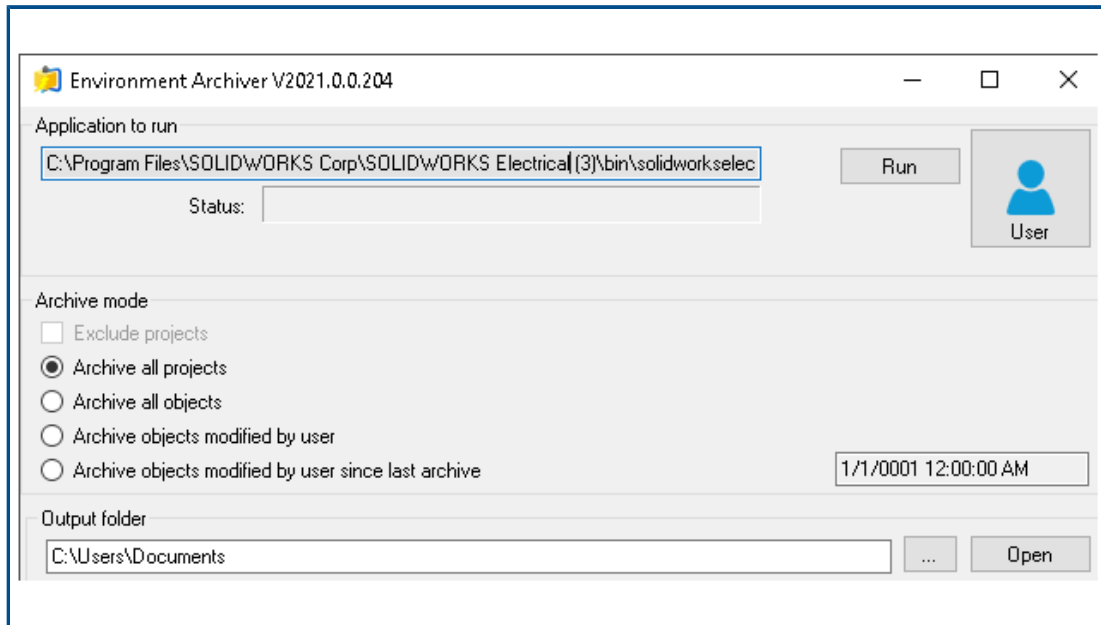

You can archive the SOLIDWORKS Electrical projects and environment by running `EwEnvironmentArchiver.exe`.

The `EwEnvironmentArchiver.exe` file runs on Windows® 10. You can schedule the archive process using Windows Task Scheduler.

To start the archiver application, do one of the following:

- From SOLIDWORKS Electrical, run the `EwEnvironmentArchiver.exe` file.
- From the Windows **Start** menu, search for `EwEnvironmentArchiver.exe` and run it.

### Archiving with the Environment Archiver

#### To archive the environment:

1. Run the `EwEnvironmentArchiver.exe` file.
2. In **Archive mode**, select the objects to archive.
3. In the **Output folder**, browse and set the output folder path.
4. Click **Archive now** or **Save** to save the settings and archive later.

### Scheduling the Archiver Using Windows Task Scheduler

#### To schedule a task:

1. Open Task Scheduler from Windows.
2. Click **Action > Create Task**.
3. In the **General** tab, enter the task name.
4. In the **Trigger** tab, click **New**, schedule the frequency and time, and click **OK**.
5. In the **Action** tab, click **New**.
6. In the **New Action** window, in **Action**, select **Start a program**.

7. In **Program/script**, click **Browse** and select the path for `EwEnvironmentArchiver.exe`.
8. Select the options under the **Conditions** and **Settings** tabs.

## SOLIDWORKS Electrical Viewer

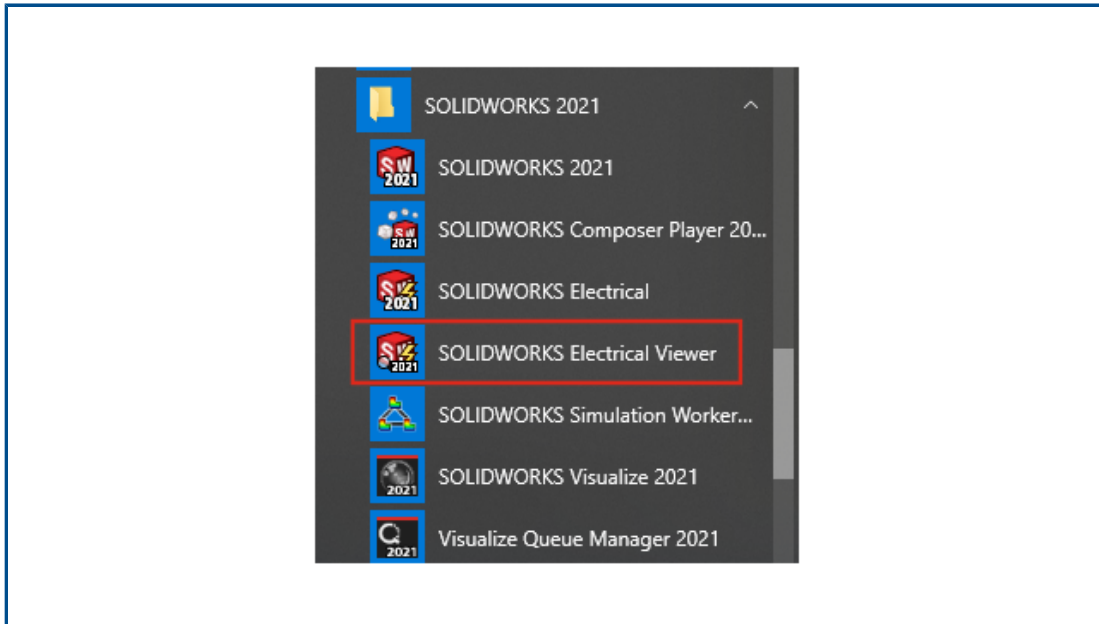

You can visualize project drawings using SOLIDWORKS Electrical Viewer.

To start the SOLIDWORKS Electrical Viewer, click **Windows Start menu > SOLIDWORKS 2021 program group > SOLIDWORKS Electrical Viewer**.

## Creating Multiple Drawings Simultaneously

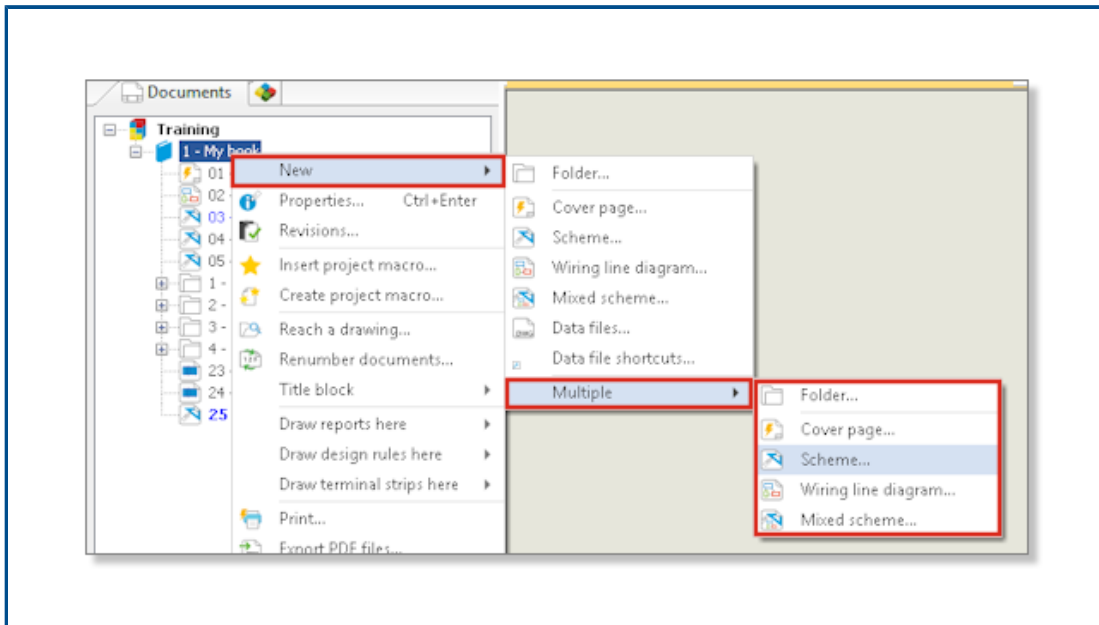

You can simultaneously create multiple drawings from a book, a folder, or a drawing. You can select both the quantity and the type of drawings.

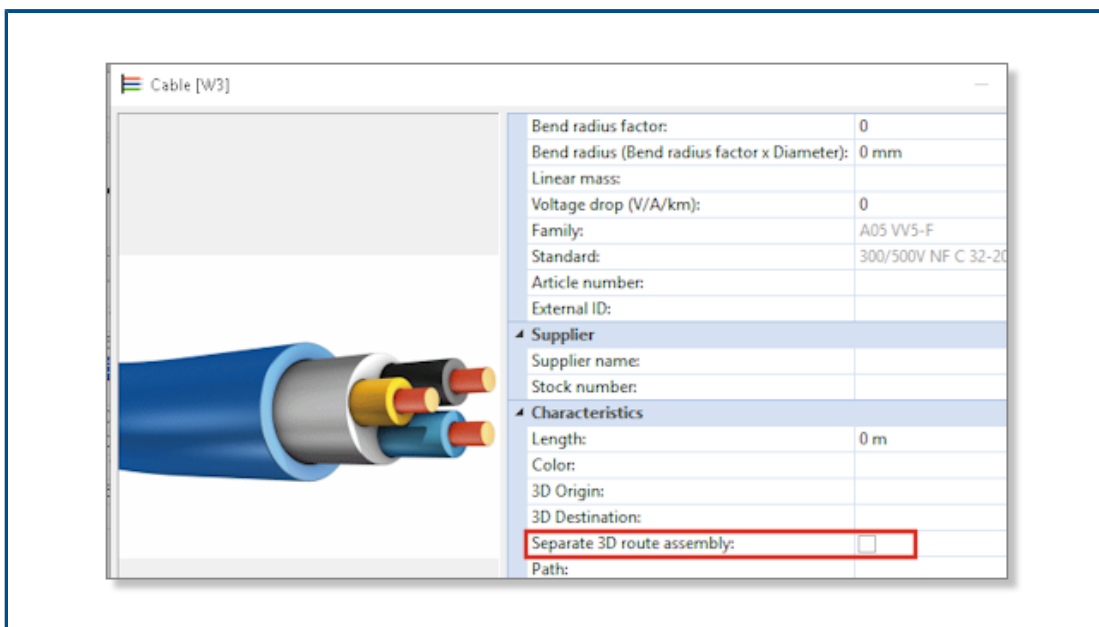

## Generating Separate Routing Assemblies of Cables



You can generate a separate routing assembly of cables. Specify the **Separate 3D route assembly** option in the cable properties. You can select one, several, or all cables to route.

### Activating the Separate Routing Assembly Parameter for a Cable

**To activate the Separate 3D route assembly parameter:**

1. In the **Project** tab, click **Cables** .
2. Select one or more cables.
3. Click **Properties** .
4. Select **Separate 3D route assembly**.

### Routing Cables in a Separate Routing Assembly

**To route the cables in which the Separate 3D route assembly parameter is activated:**

1. In the SOLIDWORKS Electrical toolbar, click **Route Cables** .
2. To open the **Cable selector**, in **Cable to route**, click **Selected cables** > **Select cables**.  
The **Separate route** column displays the status of the **Separate 3D route assembly**.
3. Start the routing.

### Using Splines in Routings

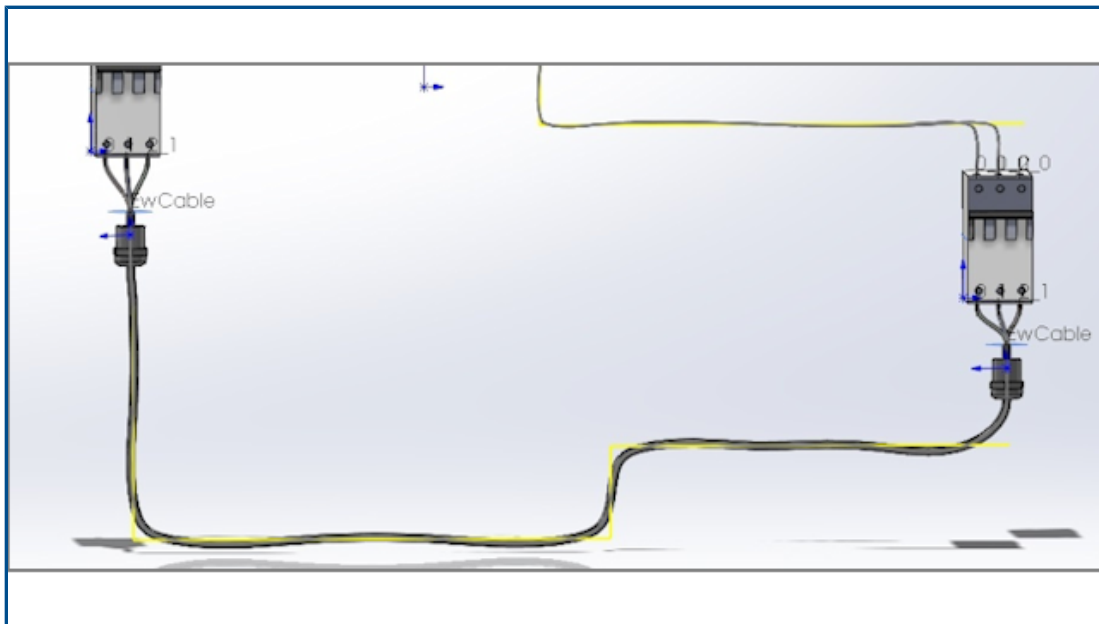

You can route electrical harnesses using splines.

You can use splines and arcs to define the **routing path** (EW\_PATH). If you use splines in the sketch to define the routing path, the routing is modeled by splines.

# 19

## SOLIDWORKS Inspection

---

This chapter includes the following topics:

- **SOLIDWORKS Inspection Add-in**
- **SOLIDWORKS Inspection Standalone**

SOLIDWORKS Inspection is a separately purchased product that you can use with SOLIDWORKS Standard, SOLIDWORKS Professional, and SOLIDWORKS Premium, or as a completely separate application (see *SOLIDWORKS Inspection Standalone*).

### SOLIDWORKS Inspection Add-in

#### Template File Locations

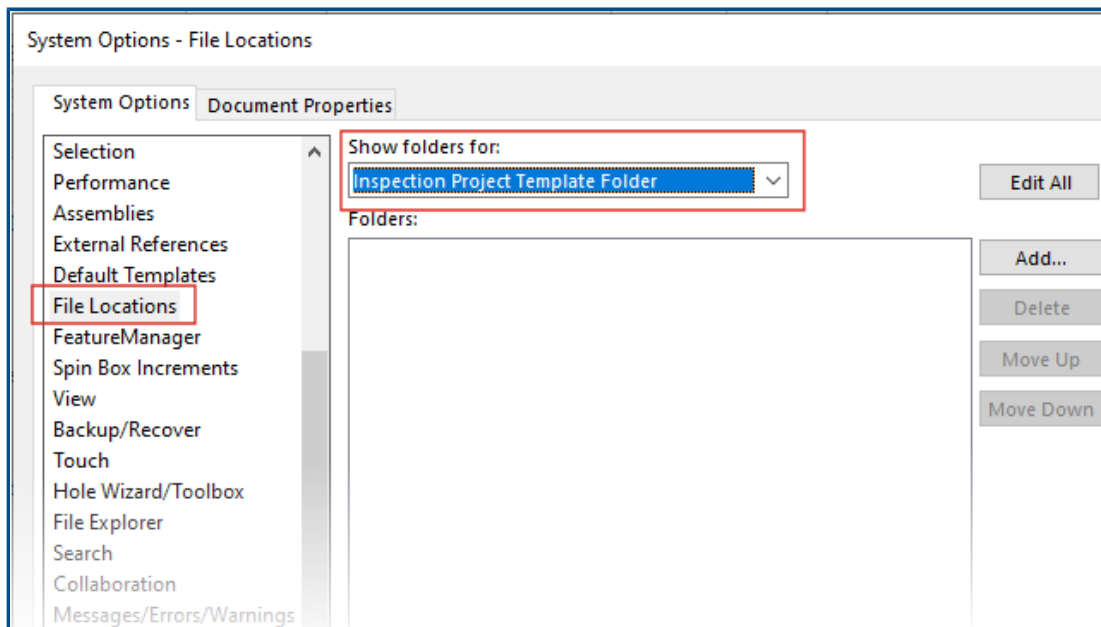

You can specify a file location for project templates and report templates. This ensures that users in multiuser environments use the correct templates, which are critical for quality control.

In SOLIDWORKS, click **Tools > Options > System Options > File Locations** and specify a file location for **Inspection Project Template Folder** and **Inspection Report Template Folder**.

## VDA Balloons

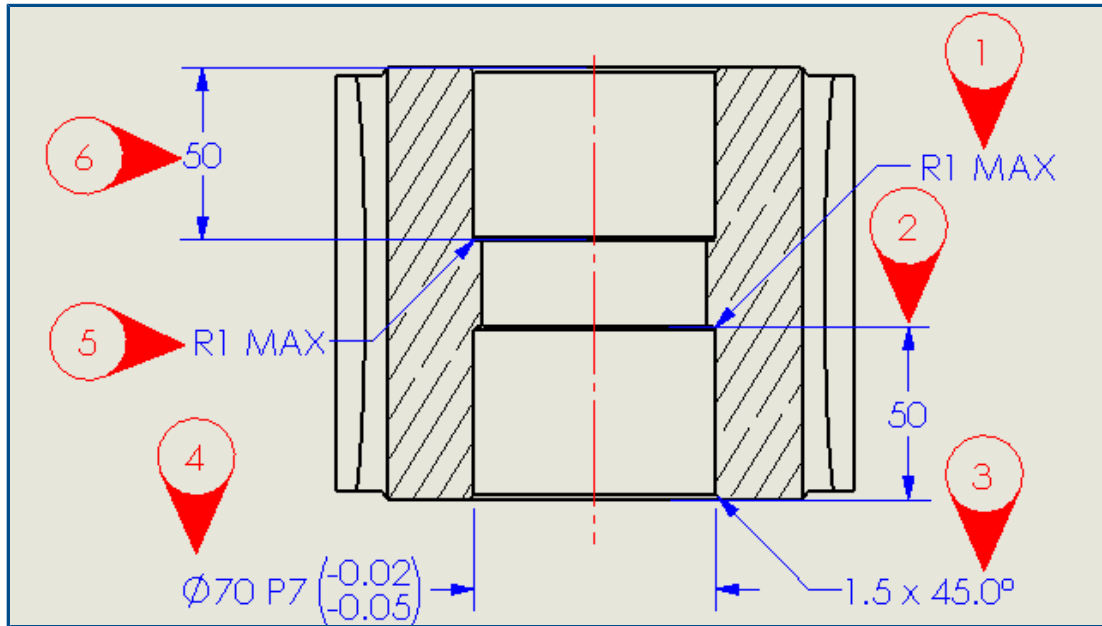

You can rotate VDA balloons while keeping the balloon number vertical. You can also adjust the font size for VDA balloons.

## SOLIDWORKS Inspection Standalone

SOLIDWORKS® Inspection is a separately purchased product that you can use with SOLIDWORKS Standard, SOLIDWORKS Professional, and SOLIDWORKS Premium, or as a completely separate application (see *SOLIDWORKS Inspection Standalone*).



## Grid Improvements

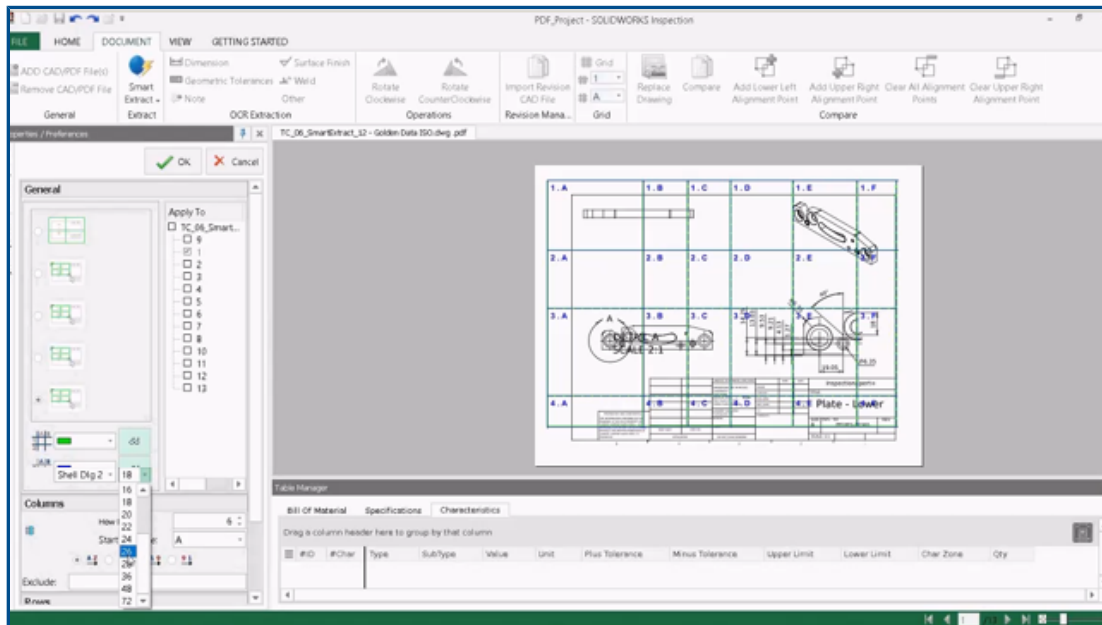

You can customize grids to help you quickly identify their characteristics.

You can:

- Change the font style and size of zone markers.
- Display dashed gridlines to be less obtrusive and reduce interference with dimensions.
- Adjust column width and row height independently. This helps users create inspection documents from legacy PDF files that might not have equally spaced columns or rows.

## SOLIDWORKS Part Support

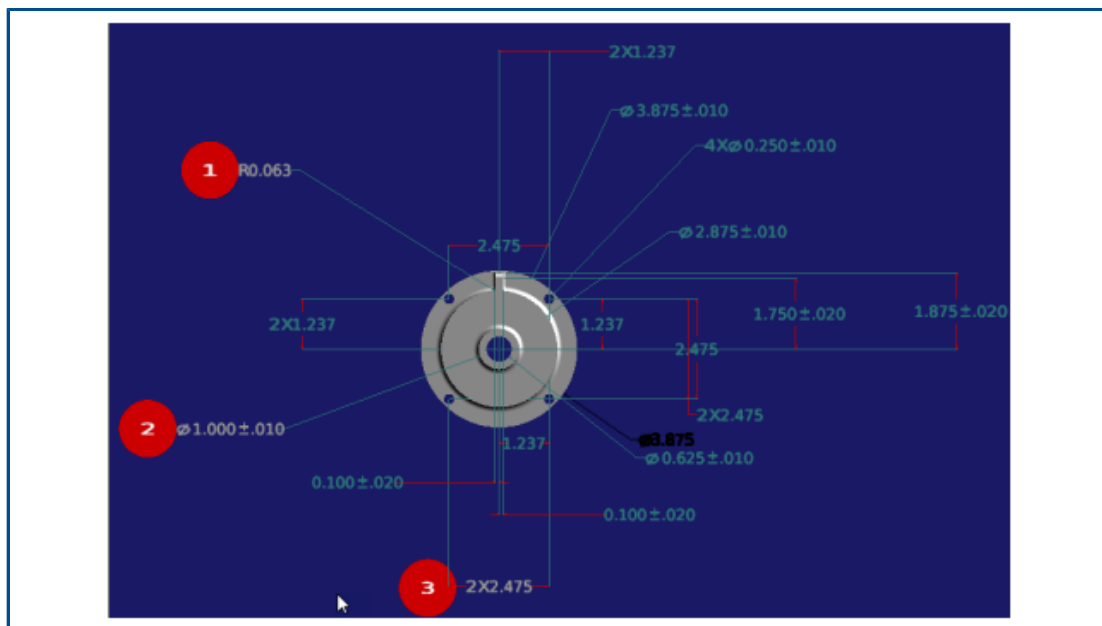

You can open SOLIDWORKS parts with 3D annotations in SOLIDWORKS Inspection Standalone to create inspection documents.

You can:

- View SOLIDWORKS parts with 3D annotations.
- Use 3D CAD data to quickly create First Article Inspection (FAI) reports.
- Read and extract 3D annotations to build reports using Smart Extract.
- Add quality control to your drawingless manufacturing strategy.

# 20

## SOLIDWORKS MBD

---

This chapter includes the following topics:

- **Datum Targets**
- **Bend Tables in 3D PDFs**

 A video thumbnail for SOLIDWORKS 2021. The text on the thumbnail reads "SOLIDWORKS 2021" in large white letters, with "EXPANDED CAPABILITIES AND PERFORMANCE" in smaller white letters below it. The background is a dark blue with faint technical drawings.	<p><b>Video: What's New in SOLIDWORKS 2021 - Model Based Definition</b></p>
---	---

SOLIDWORKS® MBD is a separately purchased product that you can use with SOLIDWORKS Standard, SOLIDWORKS Professional, and SOLIDWORKS Premium.

### Datum Targets

You can add datum target symbols to your DimXpert Dimension Scheme.

You can apply DimXpert location dimensions to datum target points and edit the dimensions to control the location of the datum targets. DimXpert datum target labels are always associated with an existing DimXpert datum. You can hide the original DimXpert datum after you apply DimXpert datum targets for it. Error checking provides feedback to let you know whether your datum targets fully define the datum.

## Bend Tables in 3D PDFs

APPROVALS		
TITLE	NAME	DATE
DRAWN	Mario	1/2020
APPROVED	Pat	6/2020

GENERAL NOTES			
UNLESS OTHERWISE SPECIFIED: DIMENSIONS ARE IN MILLIMETERS MODEL IS REQUIRED TO COMPLETE PRODUCT DEFINITION FOR ALL NON-DIMENSIONED FEATURES IN THIS DOCUMENT ALL DIMENSIONS OBTAINED FROM THE MODEL ARE BASIC UNLESS OTHERWISE SPECIFIED THE GENERAL TOLERANCE FOR ALL UNTOLERANCED			

Tag	Direction	Angle	Inner Radius
A	DOWN	90°	0.03
B	UP	90°	0.03
C	DOWN	90°	0.03
D	UP	90°	0.03
E	DOWN	90°	0.03
F	DOWN	90°	0.03
G	UP	90°	0.03
H	UP	90°	0.03

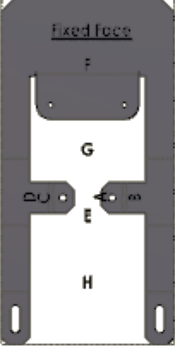
For sheet metal parts, you can include a bend table when you publish a 3D PDF.

First, edit a template and insert a placeholder for a bend table.

1. In the 3D PDF Template Editor, click **Bend Table** , and then click in the template to insert the table placeholder. You can drag and resize the placeholder.
2. Click outside of the placeholder to release it.

Then use that template when publishing a 3D PDF for a sheet metal part that has a bend table.

1. Click **Publish to 3D PDF**  (MBD toolbar or 3D Views tab).
2. In the Template Selection dialog box, select the template and click **OK**.
3. In the Publish to 3D PDF PropertyManager, under **Bend Table**, select a bend table and columns to include.

# 21

## eDrawings

---

This chapter includes the following topics:

- **Annotations in 3D Views**
- **File Properties**
- **Measure**
- **Measure and Move in Save as eDrawings Web HTML**

	<b>Video: What's New in SOLIDWORKS 2021 - eDrawings</b>
---	---

eDrawings® Professional is available in SOLIDWORKS® Professional and SOLIDWORKS Premium.

### Annotations in 3D Views

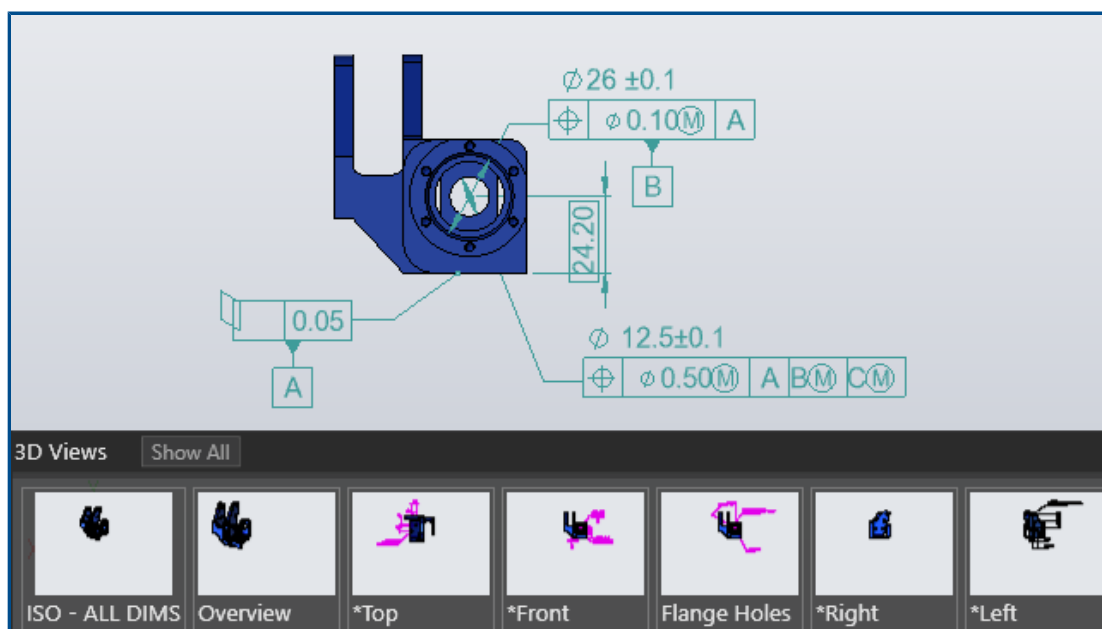

eDrawings displays annotations in the text scale specified for the 3D View in SOLIDWORKS part and assembly files.

## File Properties

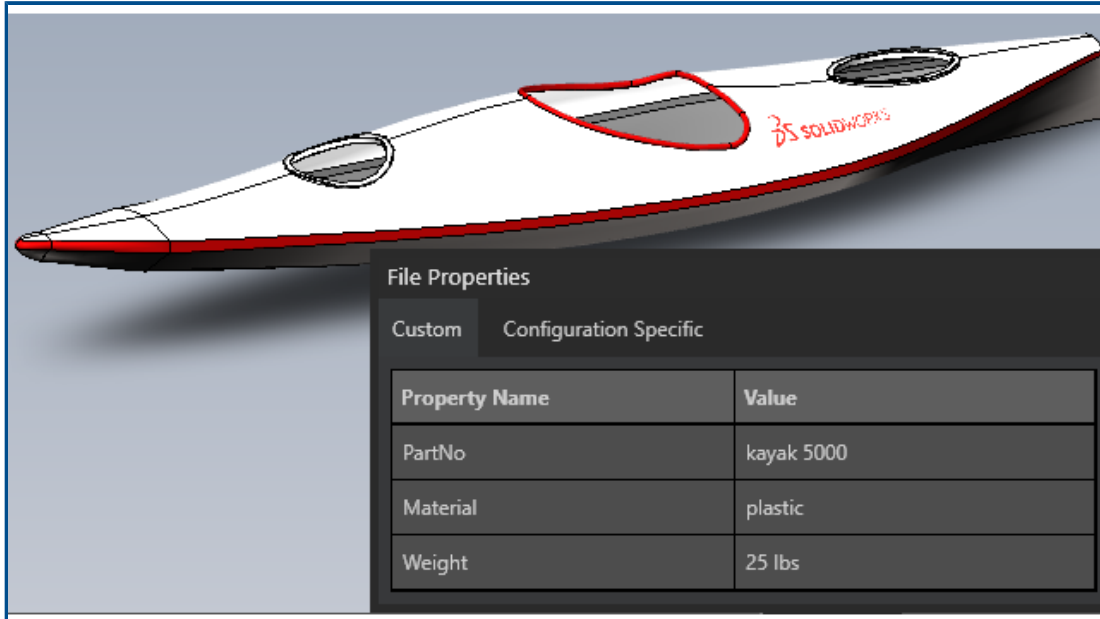

You can view the custom and configuration-specific properties of SOLIDWORKS files in eDrawings.

Click **Tools** > **File Properties** or **File Properties**  to display the names and values for **Custom** and **Configuration Specific** property values.

Configuration-specific data is available for the last-saved configuration and for configurations where you selected **Add Display Data Mark** in SOLIDWORKS, for SLDPRJ and SLDASM files only.

## Measure

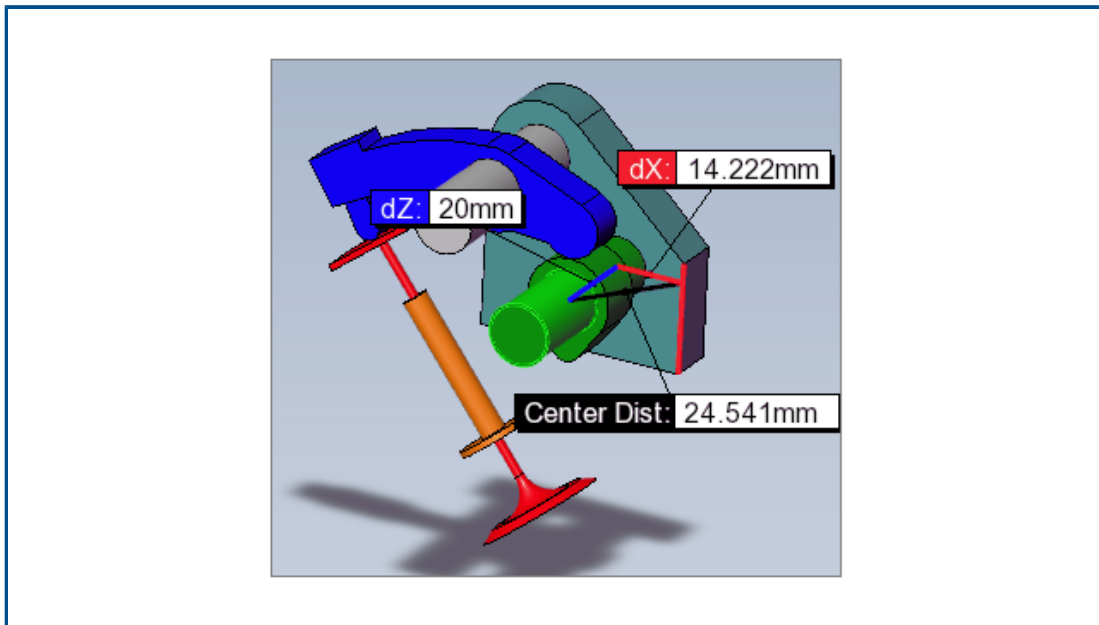

You can use the **Measure** tool to measure distances between planar-cylindrical and cylindrical-cylindrical faces. Different options specify the distance to measure when you select arcs or circles.

Click **Measure** , and select:

- A planar face and a cylindrical face. The normal distance is displayed.
- Two cylindrical faces. In the Measure pane, under **Arc/Circle Measurements**, specify **Distance** as **Center to Center**, **Minimum Distance**, or **Maximum Distance**.

## Measure and Move in Save as eDrawings Web HTML

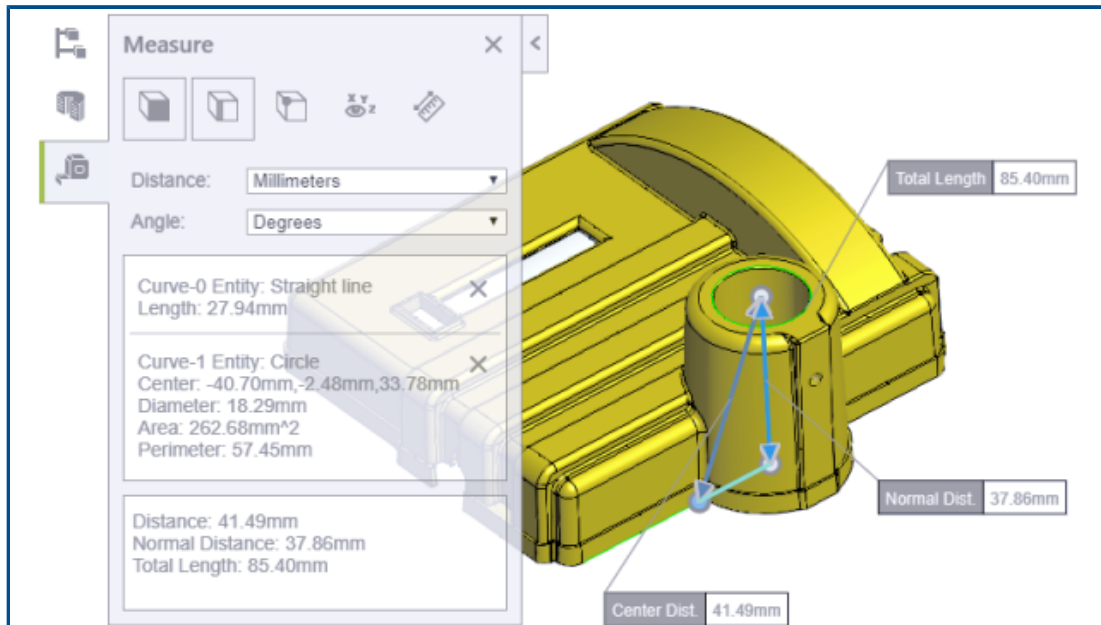

eDrawings Web HTML files support the **Move** and **Measure** tools.

**Move** is available for assembly files (.EASM, .SLDASM). **Measure** is available for all eDrawings and SOLIDWORKS file formats.

In eDrawings, click **File > Save As**. From **Save as type**, select **eDrawings Web HTML Files (\*.html)** and select **Enable measure**. **Measure** is automatically disabled if you create the HTML file from a measure-disabled file.



# 22

## SOLIDWORKS Flow Simulation

---

This chapter includes the following topics:

- **Free Surface with Rotating System**
- **Creating Plots from Scene Template**
- **Filtering Hidden Bodies in Component Control**
- **Calculating Minimum and Maximum Values from Plots**
- **Customizing Visualization Parameters**

SOLIDWORKS® Flow Simulation is a separately purchased product that you can use with SOLIDWORKS Standard, SOLIDWORKS Professional, and SOLIDWORKS Premium.

	<p><b>Video: What's New in SOLIDWORKS 2021 - Flow Simulation</b></p>
--	--

### Free Surface with Rotating System

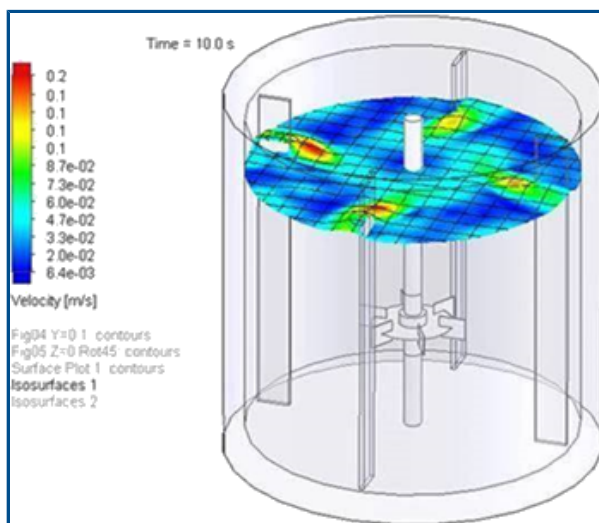

You can calculate free surface for models, including rotating equipment. This simulates fluid flow subjected to rotating systems as mixers for items such as consumer products, pharmaceuticals, and food.

In previous versions, you could not use the free surface and rotating system functionality simultaneously. Now you can combine these to predict the surface between two fluids (liquid-liquid or liquid-gas) with a rotating system.

## Creating Plots from Scene Template

You can create plots from the Scene template so you can share results between different models.

## Filtering Hidden Bodies in Component Control

You can show hidden or duplicated bodies in the Component Control dialog box.

## Calculating Minimum and Maximum Values from Plots

The software calculates the minimum and maximum value of cropped plots.

## Customizing Visualization Parameters

You can customize visualization parameters for post-processing results.

# 23

## SOLIDWORKS Plastics

---

This chapter includes the following topics:

- **Redesigned PlasticsManager Tree**
- **SOLIDWORKS Plastics Enhancements**
- **Multi-Material Overmolding Injection Process**
- **Enhanced Modeling of Baffles and Bubblers**
- **Enhanced Modeling of Sketch-Based Runners**
- **Delay Time Option for Co-Injection Processes**
- **A-B-A Sequence of a Co-Injection Process**
- **Access to Material Databases**
- **Material Database Plots**
- **Material Library Updates**
- **Plastics Tutorials**



**Video: What's New in SOLIDWORKS 2021 - Plastics**

SOLIDWORKS® Plastics Standard, SOLIDWORKS Plastics Professional, and SOLIDWORKS Plastics Premium are separately purchased products that you can use with SOLIDWORKS Standard, SOLIDWORKS Professional, and SOLIDWORKS Premium.

## Redesigned PlasticsManager Tree

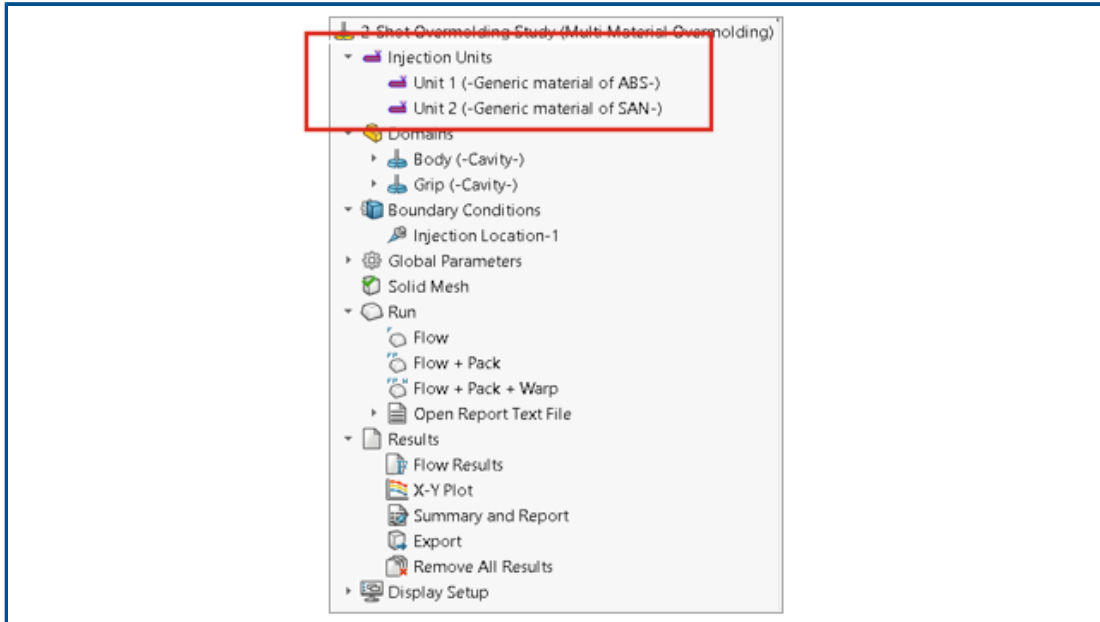

The PlasticsManager tree is redesigned to provide a more streamlined and logical workflow for creating plastics simulation studies. A new node, **Injection Units**, replaces **Injection System**.

The injection unit specifies the material and process parameters. An injection process can have one or more injection units. For example, a Gas-assisted injection process uses two injection units, one for the polymer and another for the gas. Similarly, a two-shot overmolding process uses two injection units for two polymer materials.

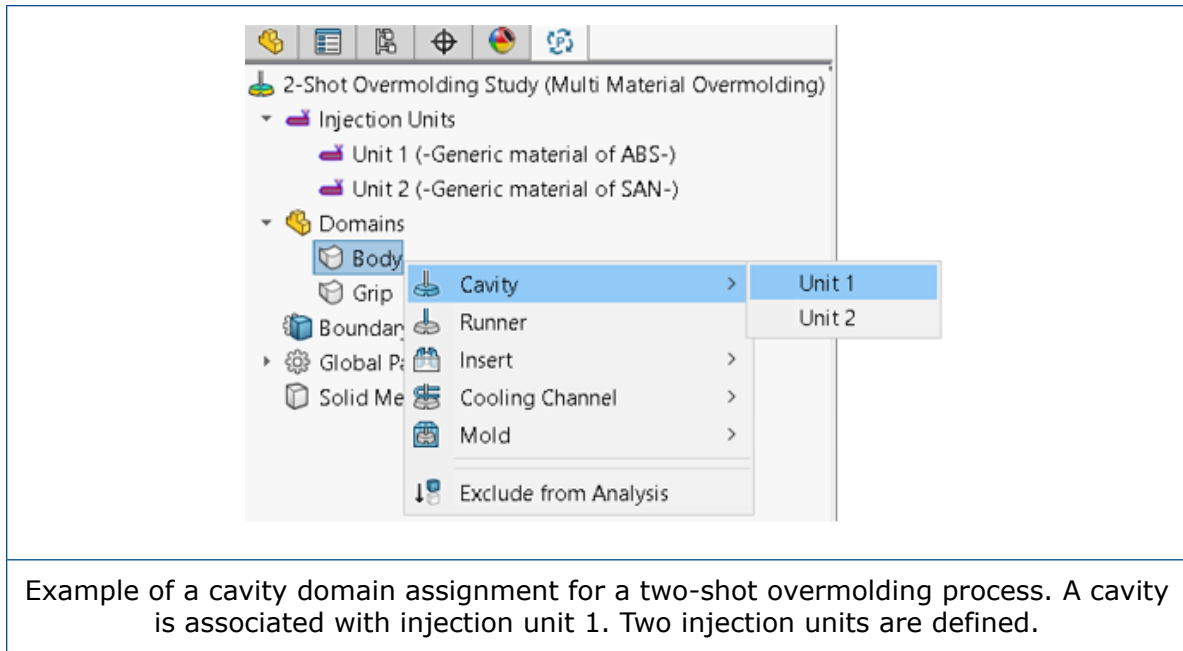

## SOLIDWORKS Plastics Enhancements

The SOLIDWORKS Plastics solver is enhanced to improve the overall accuracy of simulation results.

- The **Mold-Melt Heat Transfer Coefficient** parameter in the Injection Unit Settings PropertyManager is available for the Shell analysis procedure. Use this parameter to model the heat transfer between the polymer and the mold walls during the Filling stage of the injection molding process.

In previous releases, this parameter was available for the Solid analysis procedure only and for the SOLIDWORKS Plastics Professional and SOLIDWORKS Plastics Premium products. This parameter is now available for the SOLIDWORKS Plastics standard as well.

- For the Shell analysis procedure, the Flow and Pack analyses support multipoint material data and specific heat (C) and thermal conductivity (K) material properties that can vary with temperature.

## Multi-Material Overmolding Injection Process

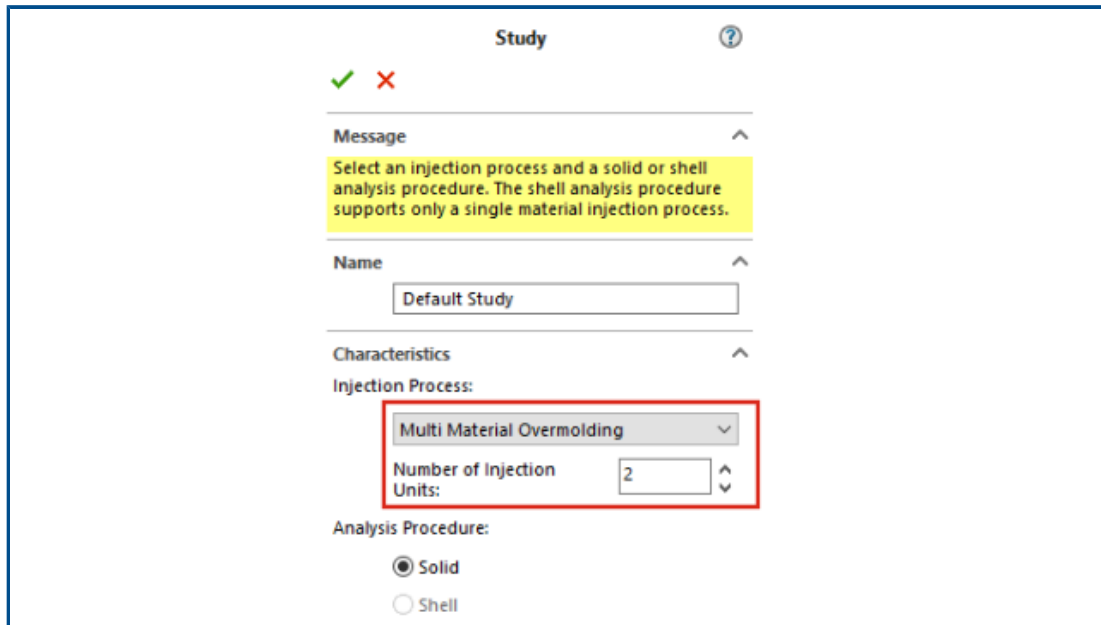

You can inject two to six different polymer materials within the same cycle.

In the Study PropertyManager, under **Injection Process**, select **Multi Material Overmolding**. During a multi-material overmolding injection, separate injection nozzles introduce materials sequentially into the cavities.

This injection process is available only with the **Solid** analysis procedure and runs with the **Flow+Pack** analysis sequence. The **Flow+Pack** analysis sequence accurately simulates an actual multi-material overmolding injection process. The first material goes through a complete Filling, Packing, and Cooling cycle before the start of the injection of the second material.

For two-shot or multi-shot overmolding designs, you can use the **Local Gravity** boundary condition to specify the gravity direction for each cavity. This is useful in cases where various cavities have different orientations in a mold and the gravity direction changes for each cavity.

## Enhanced Modeling of Baffles and Bubblers

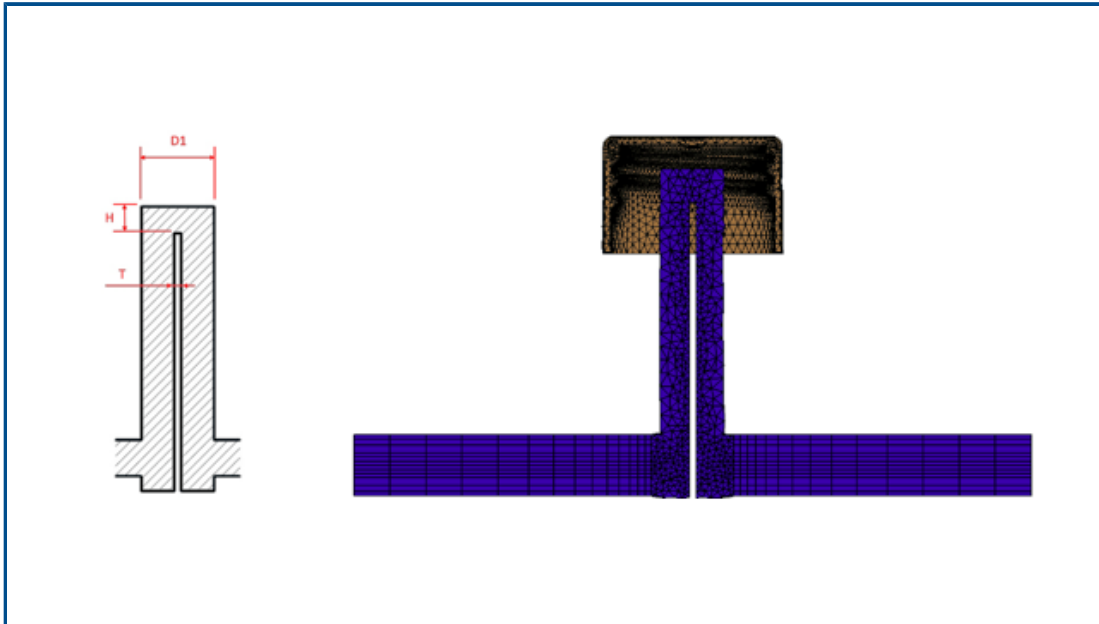

Modeling is improved for baffles and bubblers that are part of cooling system components.

For baffle cooling components, a blade inserted in a channel splits the flow passage. To accurately model the flow passage through a baffle cooling component, specify the diameter ( $D1$ ), the blade thickness ( $T$ ), and tip height ( $H$ ). Previously, only the diameter ( $D1$ ) of the baffle was required. The image shows a cross-section of a baffle design (left side) and the hexahedral mesh of a baffle cross-section (right side).

For bubblers, an inner tube replaces the blade. To accurately model a bubbler cooling component, specify the outer ( $D1$ ) and inner tube diameters ( $D2$ ), the tube thickness ( $T$ ), and the tip height ( $H$ ). Previously, only the outer ( $D1$ ) and inner tube diameters ( $D2$ ) were required.

The enhanced modeling of the baffle and bubbler flow channel enables the creation of an accurate hexahedral mesh across the cross section. This more-accurate mesh representation improves the overall accuracy of the coolant flow and the mold cooling solutions.

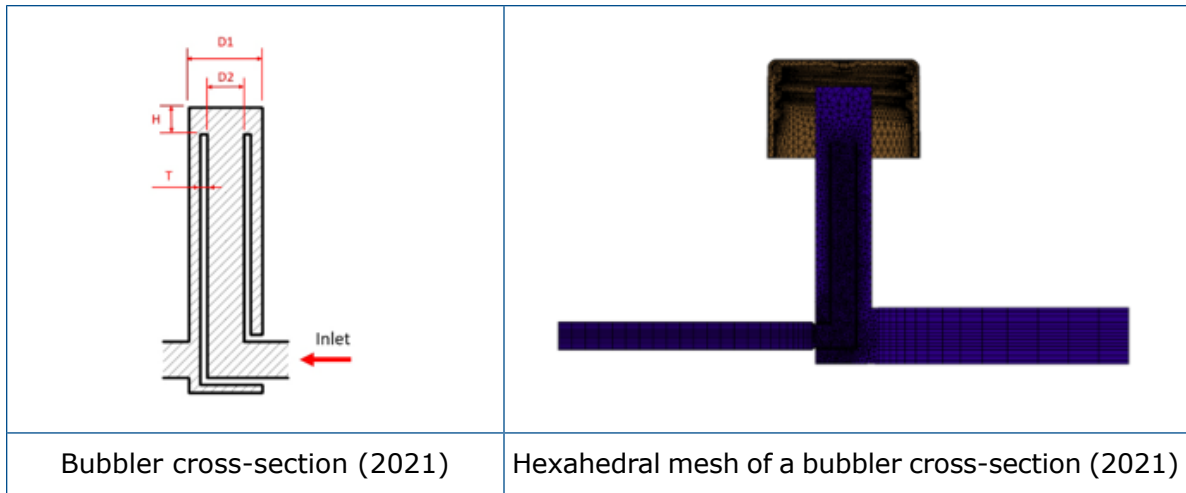

## Enhanced Modeling of Sketch-Based Runners

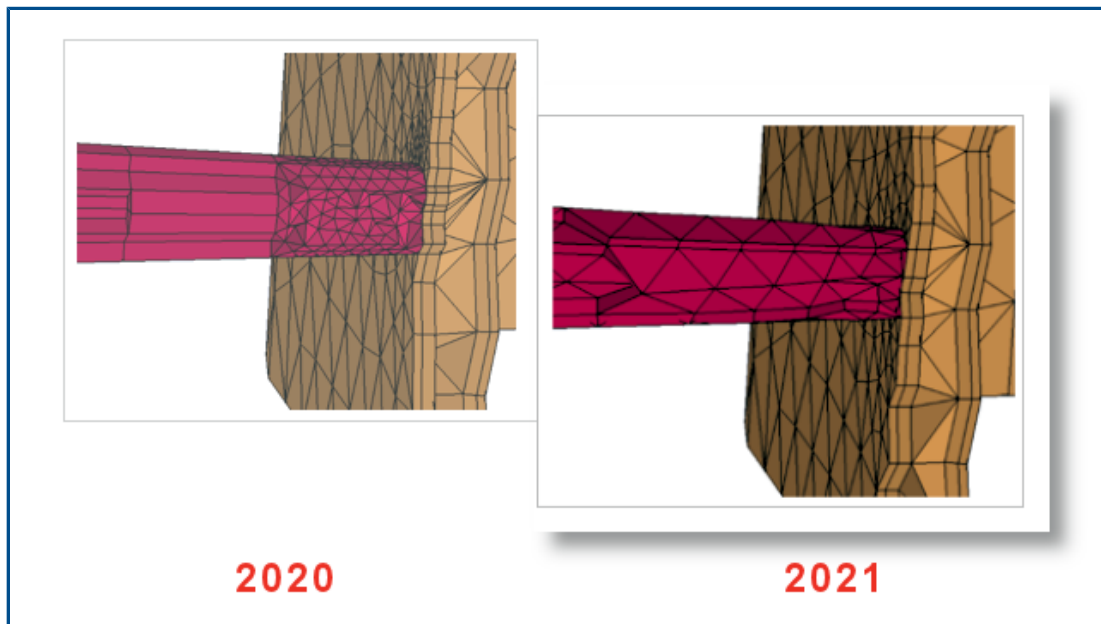

Two key enhancements to the sketch-based runner design are available in this release.

- The enhanced algorithm for the runner design integrates SOLIDWORKS APIs to create realistic shapes of runner cross-sections and runner junctions from sketch lines.
- Enhanced meshing algorithms apply tetrahedral elements at the core and prism elements at the boundary layer when you mesh runners. This element combination leads to better convergence and results. Previously, a single layer of prism elements was applied to the core, and the rest of the cross-section, including boundary layers, was meshed with hexahedral elements.



## Delay Time Option for Co-Injection Processes

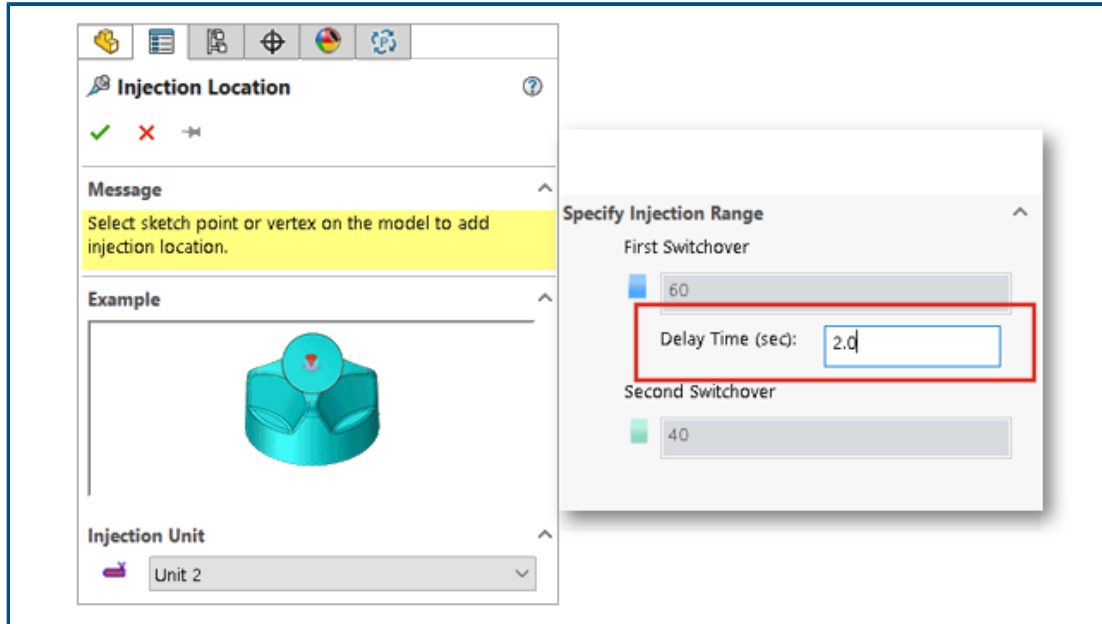

You can specify a delay time between injections of the first and second material for Co-injection, Gas-assist, and Water-assist processes.

The image shows a setting for a Gas-assist injection molding process. The cavity is filled to 60% capacity with polymer when the switch to nitrogen gas is initialized. The gas injection begins after a 2-second time delay.

## A-B-A Sequence of a Co-Injection Process

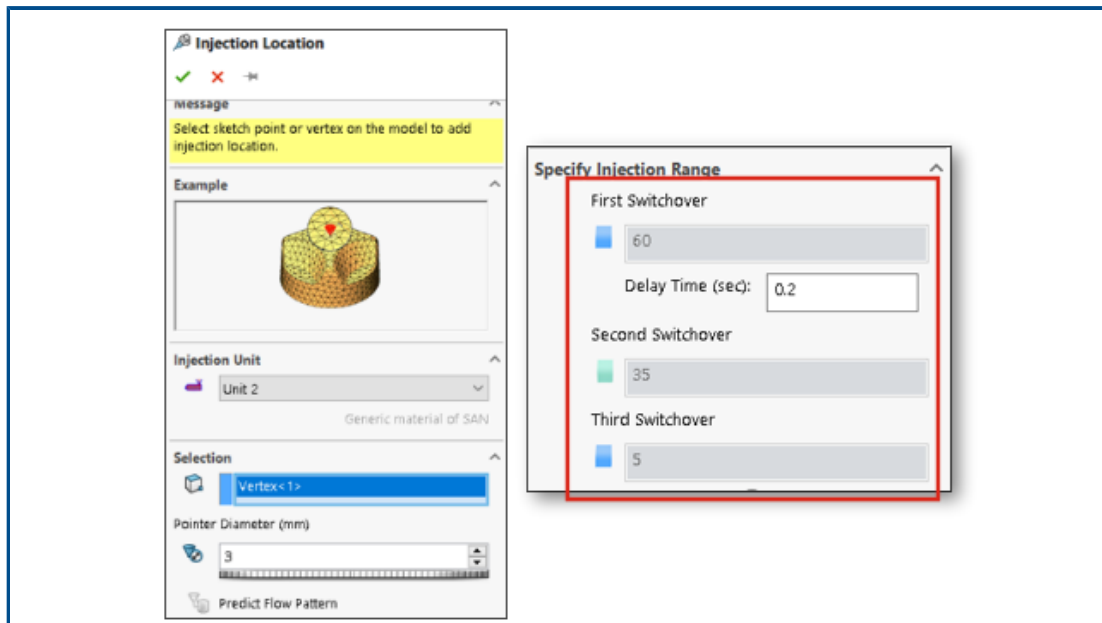

You can simulate an A-B-A sequence of a Co-injection molding process.

During an A-B-A sequence, first a skin material (polymer A) is injected followed by a core material (polymer B). Toward the end of the process, a small amount of the skin material is reinjected to ensure the complete encapsulation of the core material.

The image shows settings for an A-B-A sequence where 60% of the cavity fills with material A. After a time delay of 0.2 seconds, material B is injected to fill 35% of volume. Injection switches back to material A to fill the last 5% of cavity volume.

## Access to Material Databases

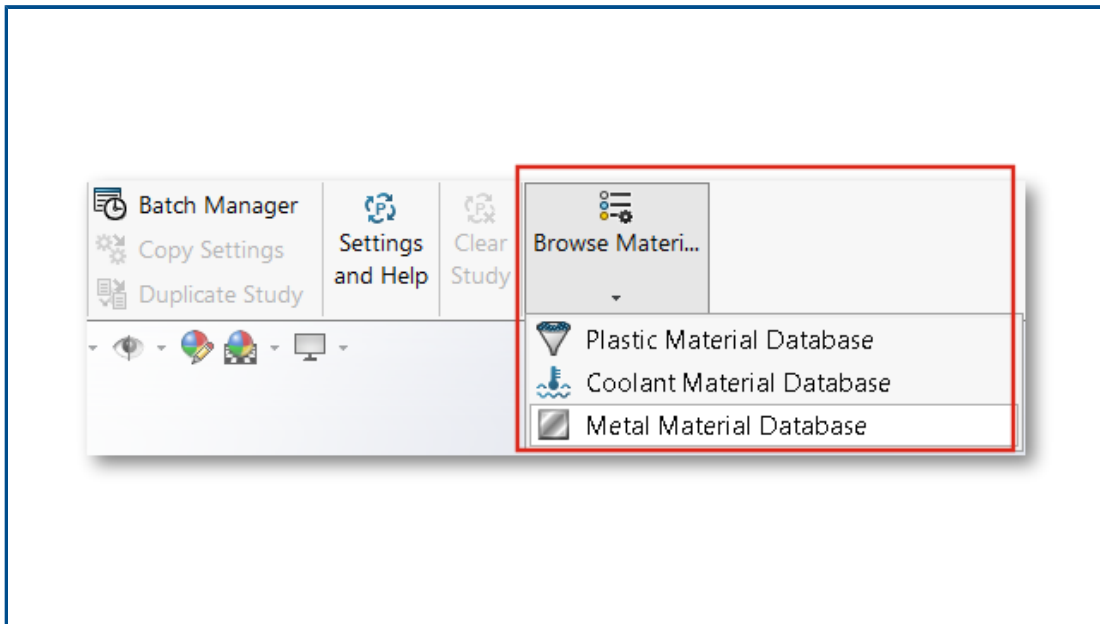

You can access the Plastics, Coolant, and Metal material databases before creating a Plastics study.

In the Plastics CommandManager, click **Browse Material Database** to research, edit, or customize materials.

To browse the material databases, the SOLIDWORKS Plastics add-in must be active. While you can browse and customize materials, you cannot assign them to a Plastics study.

## Material Database Plots

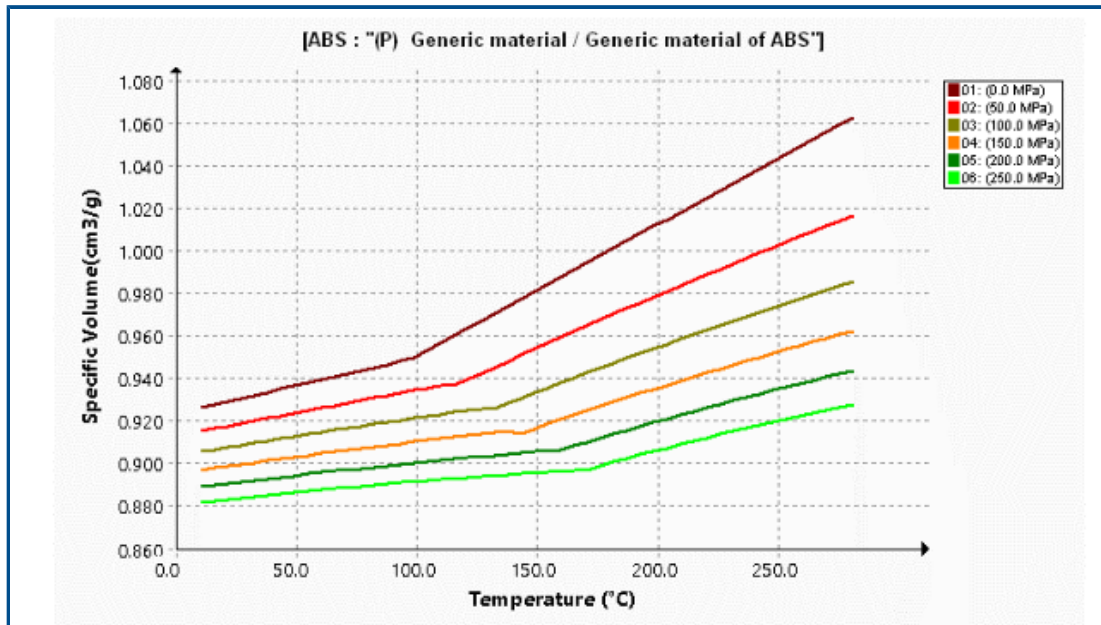

There are several enhancements to the display of Viscosity and Pressure-Volume-Temperature (PVT) plots.

Viscosity Plots Enhancements	PVT Plots Enhancements
Reduced the default number of isotherm plots from 10 to 5 to reduce visual clustering of the curves.	Reduced the default number of isobars from 10 to 6. The 6 isobars display the pressure values at: 0, 50, 100, 150, 200, and 250 MPa.
Increased the number of temperature datasets for generating viscosity curves to 5.	Increased the number of pressure datasets for generating PVT curves to 4.
Plot markers are removed. The software generates the plots from the Cross-WLF Viscosity model coefficients.	Plot markers are removed. The software generates the plots from the Modified Tait model coefficients.
The default range of the shear rate values on the X-axis is modified to be 1 to 100,000 (the previous range was 0.0001 to 10,000).	

**Viscosity Plots Enhancements**

**PVT Plots Enhancements**

This range better fits the shear rates during typical injection molding cycles.

**Material Library Updates**

51 Dow Chemical	194 Trinseo
<input type="checkbox"/> 1 ABS / LUSTRAN ABS H801	<input type="checkbox"/> 1 ABS / MAGNUM 3325
<input type="checkbox"/> 2 ABS / LUSTRAN ABS H802	<input checked="" type="checkbox"/> 2 ABS / MAGNUM 3404
<input type="checkbox"/> 3 ABS / MAGNUM 2620	<input type="checkbox"/> 3 ABS / MAGNUM 3416 SC
<input type="checkbox"/> 4 ABS / MAGNUM 2630	<input type="checkbox"/> 4 ABS / MAGNUM 342 EZ
<input type="checkbox"/> 5 ABS / MAGNUM 2642	<input type="checkbox"/> 5 ABS / MAGNUM 3453
<input type="checkbox"/> 6 ABS / MAGNUM 275	<input type="checkbox"/> 6 ABS / MAGNUM 3504
<input type="checkbox"/> 7 ABS / MAGNUM 3105 GF	<input type="checkbox"/> 7 ABS / MAGNUM 3513
<input type="checkbox"/> 8 ABS / MAGNUM 3219 HH	<input type="checkbox"/> 8 ABS / MAGNUM 3616
<input type="checkbox"/> 9 ABS / MAGNUM 3305 GF	<input type="checkbox"/> 9 ABS / MAGNUM 3661
<input type="checkbox"/> 10 ABS / MAGNUM 3391	<input type="checkbox"/> 10 ABS / MAGNUM 3904
<input checked="" type="checkbox"/> 11 ABS / MAGNUM 3404	<input type="checkbox"/> 11 ABS / MAGNUM 8434
<input type="checkbox"/> 12 ABS / MAGNUM 3416 HH	<input type="checkbox"/> 12 GPPS / STYRON 6500
<input type="checkbox"/> 13 ABS / MAGNUM 3416 SC	<input type="checkbox"/> 13 GPPS / STYRON 666D
<input type="checkbox"/> 14 ABS / MAGNUM 342EZ	<input type="checkbox"/> 14 GPPS / STYRON 678
<input type="checkbox"/> 15 ABS / MAGNUM 344 HP	<input type="checkbox"/> 15 GPPS / STYRON 678 D
<input type="checkbox"/> 16 ABS / MAGNUM 3453	<input type="checkbox"/> 16 GPPS / STYRON 678 E
<b>2020</b>	<b>2021</b>

There are several updates to the Plastics Material Library. All updates are according to the latest data from the material manufacturer.

New Materials	Updated Materials	Reclassified Materials	Removed Materials
252 grades from Covestro	Nine grades from Covestro	31 Generic grades were renamed	Four grades from Amoco Chemical were removed
86 grades from EMS-GRIVORY	71 grades from EMS-GRIVORY	Four grades from ALBIS	31 grades from Bayer
28 grades from SABIC Innovative Plastics	Two grades from SABIC Innovative Plastics	Two grades from BASF	25 grades from Bayer Material Science
23 grades from Solvay Specialty Polymers	Two grades from Solvay Specialty Polymer	122 grades from INEOS Styrolution	42 grades from EMS-GRIVORY
		115 grades from LANXESS GMBH	One grade from GENERAL ELECTRIC
		Two grades from LyondellBasell	Nine grades from LANXESS
		One grade from SABIC Innovative Plastics	62 grades from MILES
		42 grades from Solvay Specialty Polymers	14 grades from Monsanto
		One grade from UNITIKA	One grade from Monsanto Europe
			Two grades from Monsanto Japan
			12 grades from PHILLIPS

In addition, you can use a polymer's solid density property to search for a material. For **Search Polymer Database > Options**, select **Solid Density**.

## Plastics Tutorials

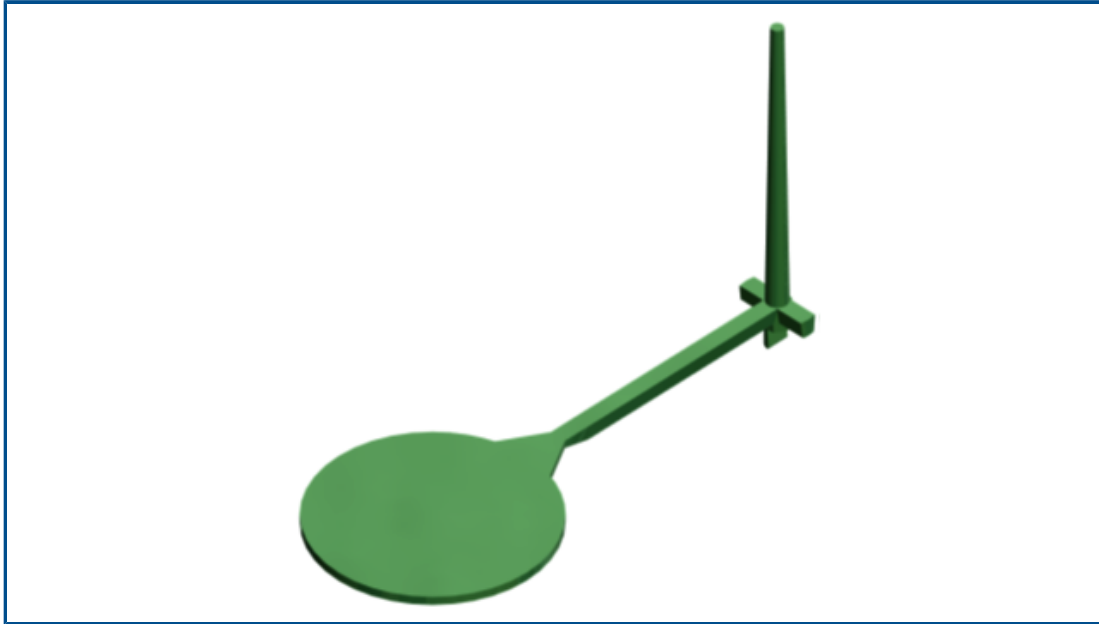

A new tutorial, *Validating Injection Molding Simulation*, is available. In this tutorial, you simulate the injection molding process, and validate the Flow and Pack results against experimental data.

The new tutorial is available with the SOLIDWORKS Plastics Professional and SOLIDWORKS Plastics Premium licenses.

To access the Plastics tutorials, from the SOLIDWORKS Plastics CommandManager, click **Settings and Help > Tutorials**.

# 24

## Routing

---

This chapter includes the following topics:

- **Routing Multiple Wires Through Clips**
- **Location of Tables in Flattened Routes**
- **Table Properties in Flattened Routes**
- **Selecting Several Routes for Electrical Attributes**
- **Keeping Cable Ends at Correct Pin Locations**
- **Locking Route Segments**
- **Hiding Empty Pin Rows**
- **Propagating Termination Type**
- **Additional Properties Available in the BOMs**
- **Splicing Without Components**
- **Selecting Components to Maintain 3D Orientation in Flatten Routes**



**Video: What's New in SOLIDWORKS 2021 - Routing**

Routing is available in SOLIDWORKS® Premium.

## Routing Multiple Wires Through Clips

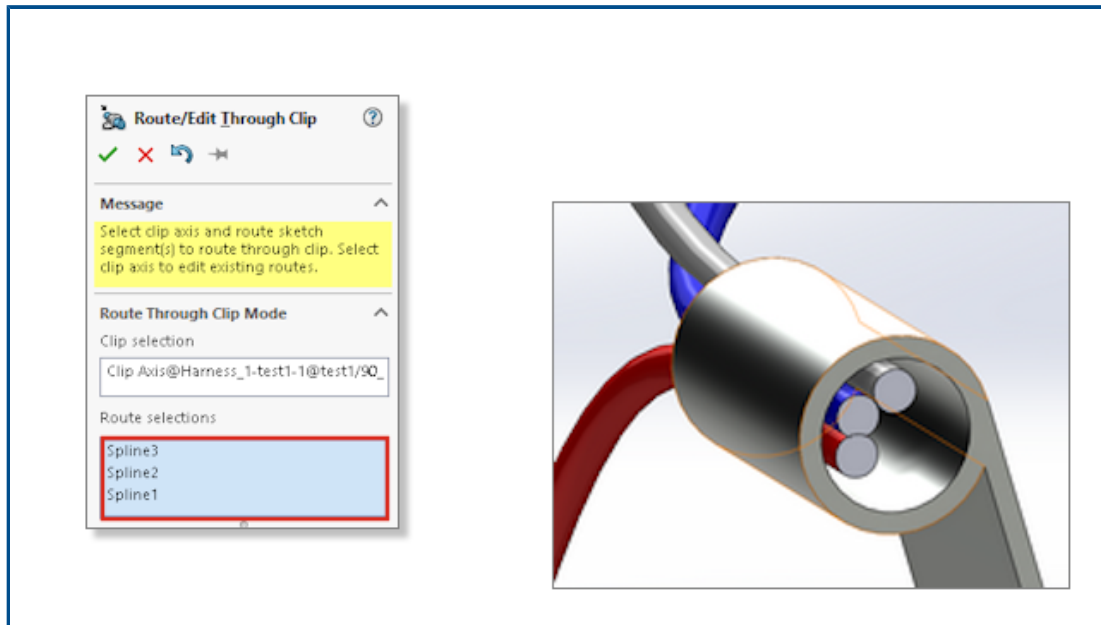

When you want to use clips in a routing assembly, you can select multiple routes simultaneously. You can also define how the cable cores appear inside the clip.

Use the **Route/Edit through Clip** PropertyManager to:

- Select several routes to pass through the clip.
- Define the alignment mode of the cables inside the clip.

## Location of Tables in Flattened Routes

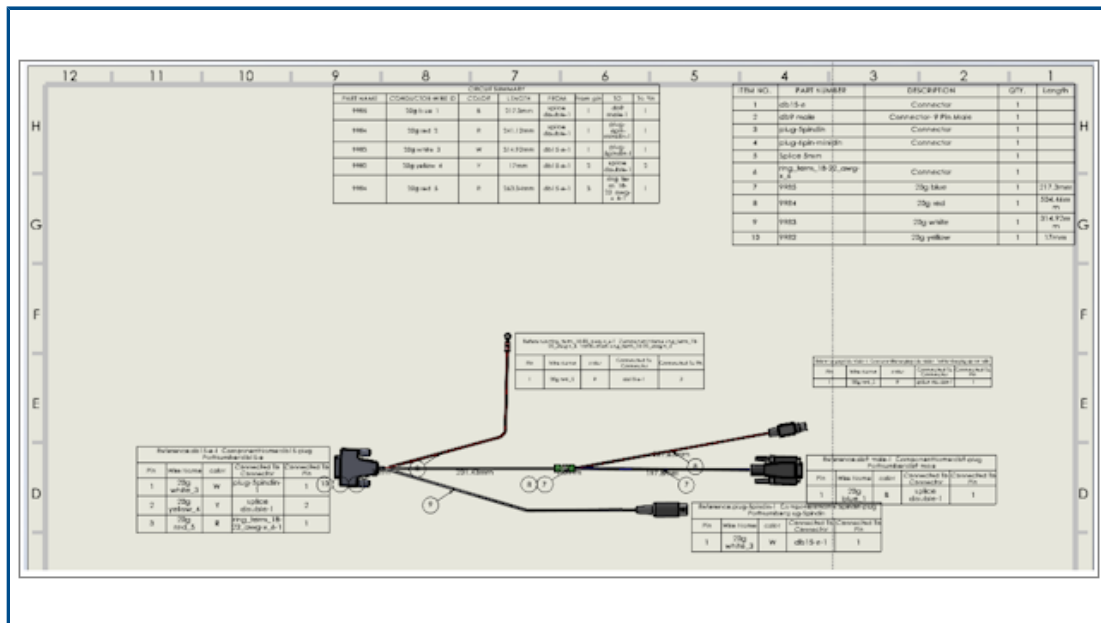



When you generate a flattened route, the tables are inserted in specific locations.

The location of tables in flattened routes has changed to position the tables more logically within the overall layout.

## Table Properties in Flattened Routes

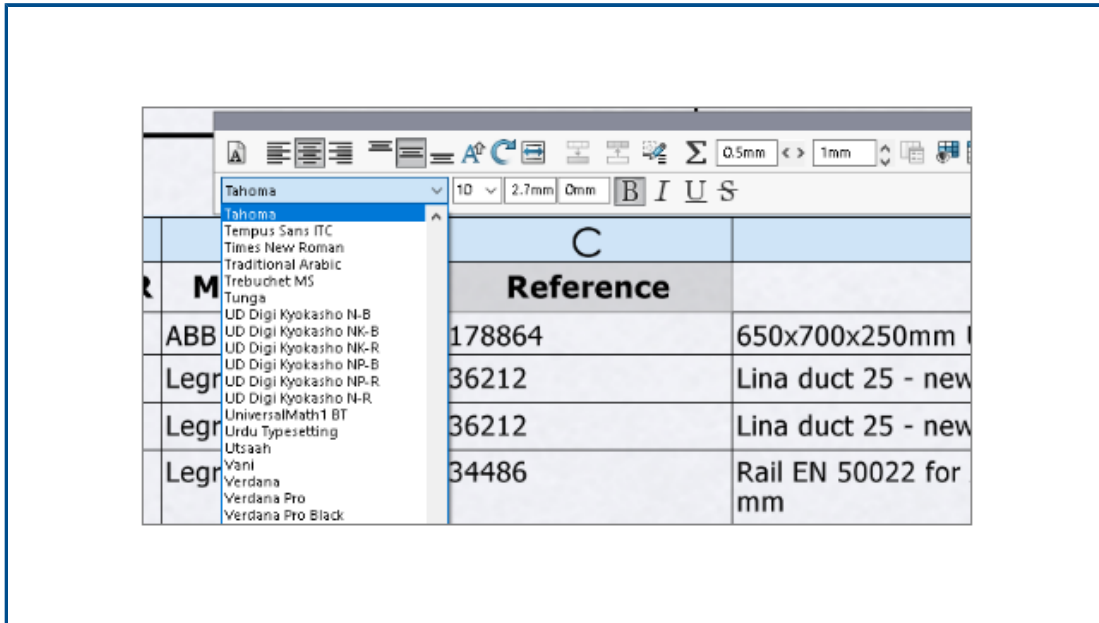

In a flattened route, when you change the parameters of a table, you can propagate these parameters to the other tables in the drawing.

You can select the font size and click Fit Text to resize the tables.

## Selecting Several Routes for Electrical Attributes

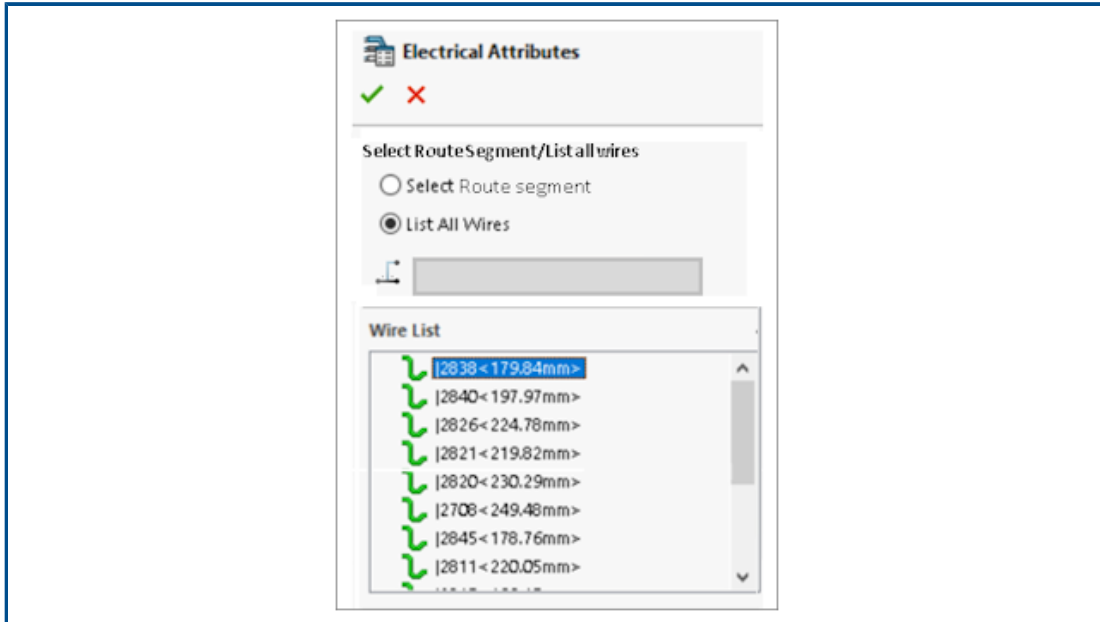

In the **Electrical Attributes** PropertyManager you can select one or more route segments or wires.

In the **Property Manager**, you have two options to select the route or the wires in the list. Depending on the selection, you can select the respective electrical attributes.

## Keeping Cable Ends at Correct Pin Locations

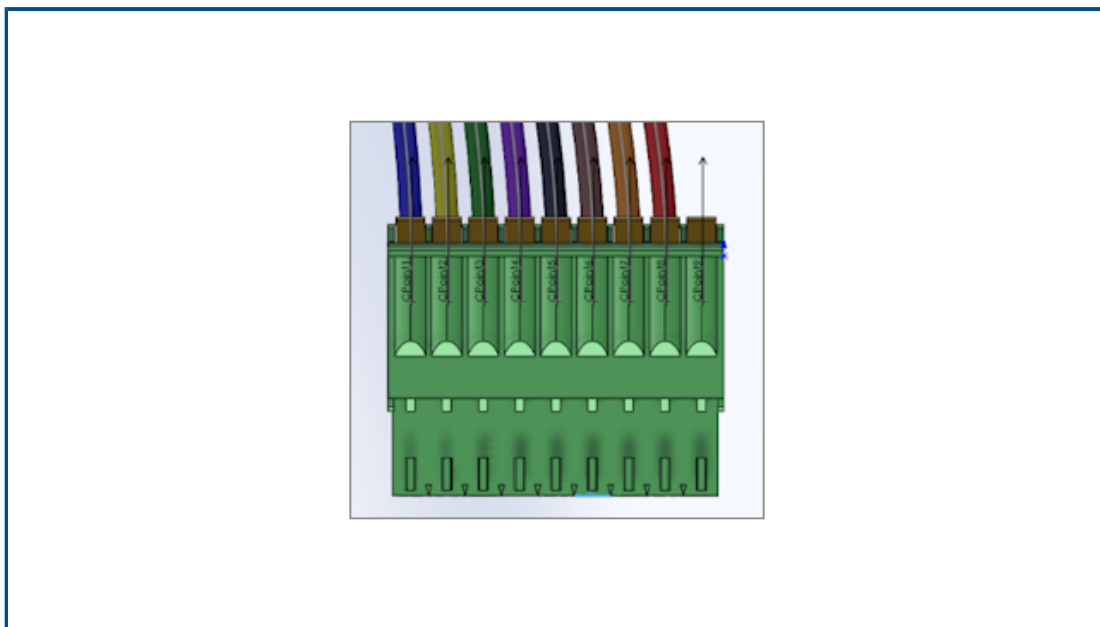

On the connector pins, the cable ends of the connector pins have the same position in the route and in the flattened route.

Also, you can manually edit the individual fan-out in the flattened route, for example, to assign the cable end to the correct pin.

## Locking Route Segments

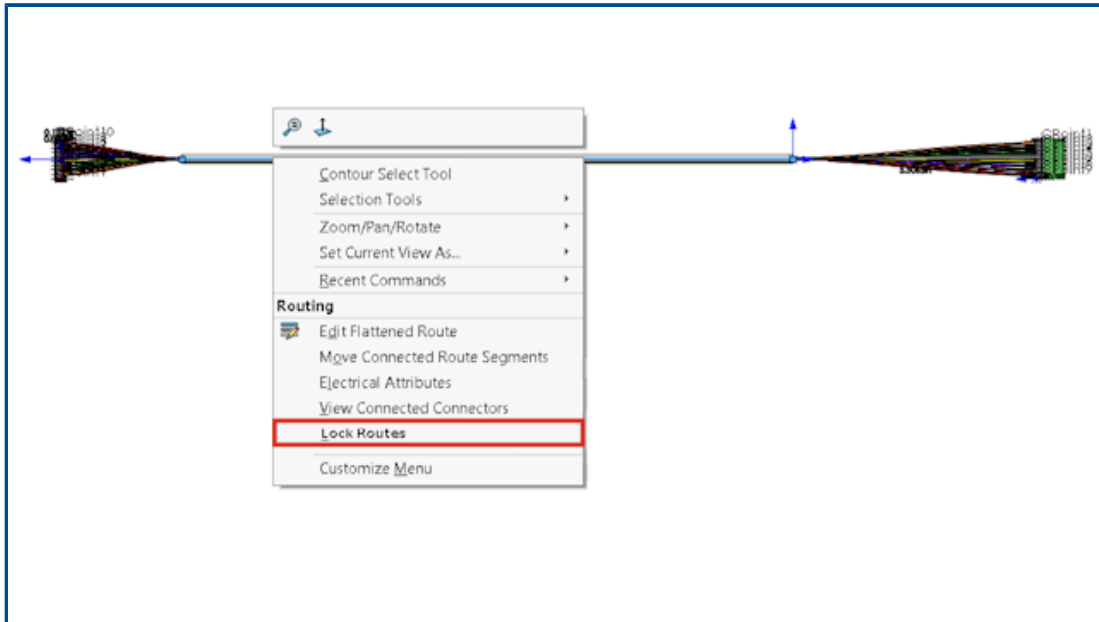

You can lock a route segment to preserve its properties when you update or modify other routes.

Right-click the route and select **Lock Routes**.

## Hiding Empty Pin Rows

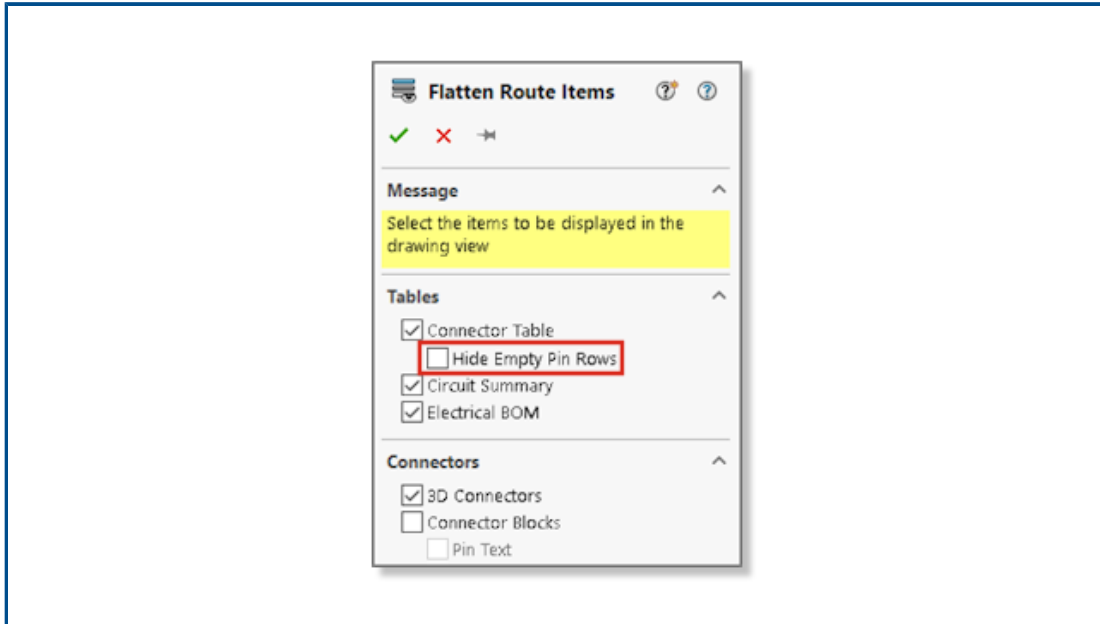

You can hide unused pins in flattened routes.

In the Flatten Route Items PropertyManager, select the **Hide Empty Pin Rows**.

## Propagating Termination Type

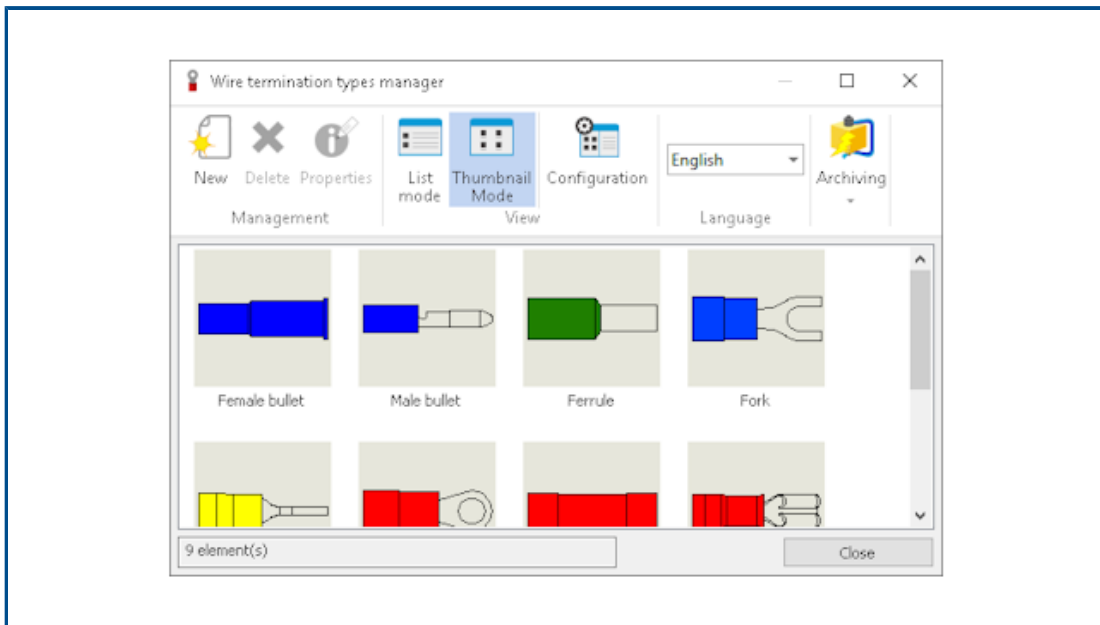

The termination type of manufacturer parts handled in SOLIDWORKS Electrical propagates automatically to the connector properties.

You can display this data in the BOM.

## Additional Properties Available in the BOMs

The image shows a software interface with two main components. On the left is a dialog box titled 'Additional Properties' with a table containing the following data:

Name	Value
Material	Carbon Steel

On the right is a larger table representing a Bill of Materials (BOM) with the following columns: QTY., Length, xyz, and Material. The 'Material' column is highlighted with a red box. The data in the BOM table is as follows:

QTY.	Length	xyz	Material
1			
2			
1			
2			
1	784.79m m		Graphite
1	783.13m m	123	
1			

You can display more properties that are assigned to connectors and wires in BOMs.

## Splicing Without Components

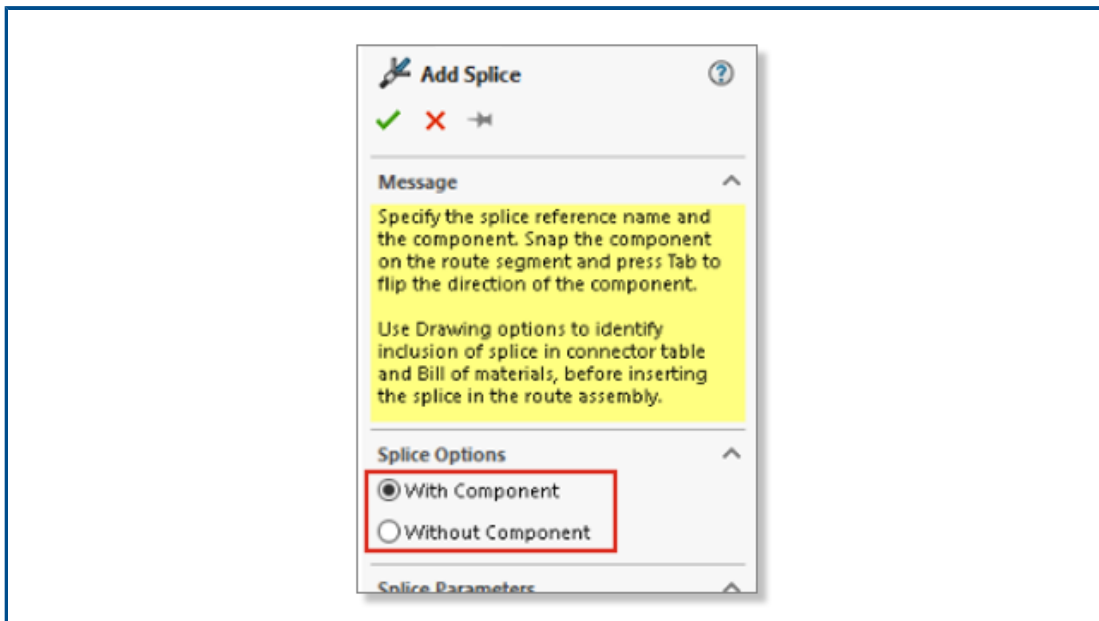

You can use a splice without component.

To add a splice, you can use the splice library. In the **Add Splice** PropertyManager, use **Use Splice Library**.

In the **Add/Edit Splice** PropertyManager, you can add notes that propagate into drawings of the flattened route. You can select the **Add Splice in Circuit Summary** to add a splice without component in the circuit summary table.

**Splices without component do not appear in BOMs.**

## Selecting Components to Maintain 3D Orientation in Flatten Routes

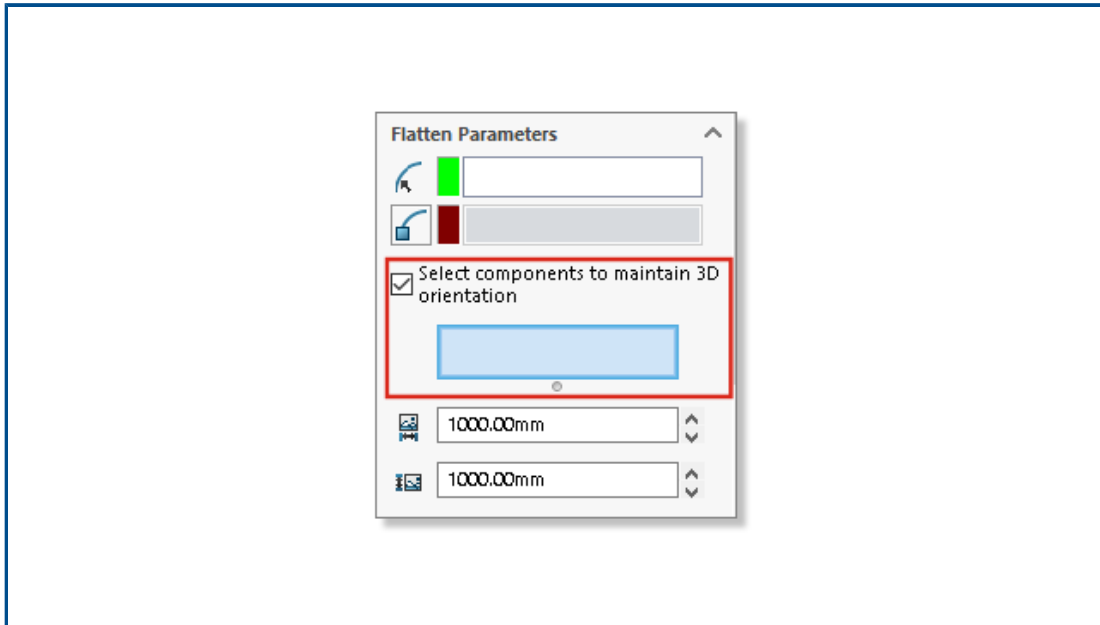

When you apply the flatten route command, you can select portions of the route to not flatten.

To exclude components from the flattened route, in the Flatten Route PropertyManager, click **Select components to maintain 3D orientation** and select components.

In the **Edit Flattened Route** PropertyManager, you can manage the orientation of the connectors.

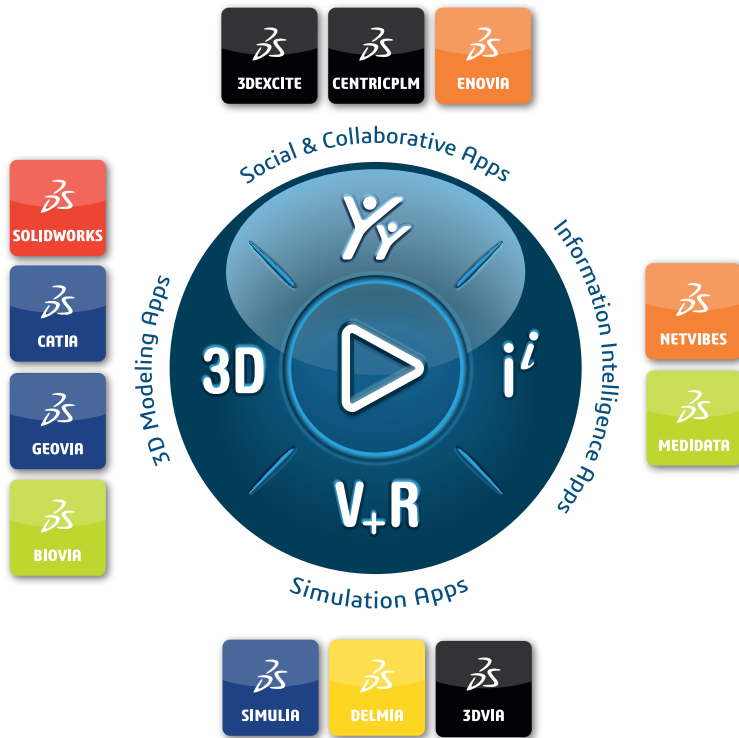

**Our 3DEXPERIENCE® platform powers our brand applications, serving 11 industries, and provides a rich portfolio of industry solution experiences.**

Dassault Systèmes, the 3DEXPERIENCE Company, is a catalyst for human progress. We provide business and people with collaborative virtual environments to imagine sustainable innovations. By creating 'virtual experience twins' of the real world with our 3DEXPERIENCE platform and applications, our customers push the boundaries of innovation, learning and production.

Dassault Systèmes' 20,000 employees are bringing value to more than 270,000 customers of all sizes, in all industries, in more than 140 countries. For more information, visit [www.3ds.com](http://www.3ds.com).

**Europe/Middle East/Africa**

Dassault Systèmes  
10, rue Marcel Dassault  
CS 40501  
78946 Vélizy-Villacoublay Cedex  
France

**Asia-Pacific**

Dassault Systèmes K.K.  
ThinkPark Tower  
2-1-1 Osaki, Shinagawa-ku,  
Tokyo 141-6020  
Japan

**Americas**

Dassault Systèmes  
175 Wyman Street  
Waltham, Massachusetts  
02451-1223  
USA

©2021 Dassault Systèmes. All rights reserved. 3DEXPERIENCE, the Compass icon, the 3DS logo, CATIA, BIOVIA, GEOVIA, SOLIDWORKS, 3DVIA, ENOVIA, NETVIBES, MEDIDATA, CENTRICPLM, 3DEXCITE, SIMULIA, DELMIA, and 3DIA are commercial trademarks or registered trademarks of Dassault Systèmes, a French "société européenne" (Versailles Commercial Register # B 222 306 440), or its subsidiaries in the United States and/or other countries. All other trademarks are owned by their respective owners. Use of any Dassault Systèmes or its subsidiaries trademarks is subject to their express written approval.